

CITY OF SAN MARINO

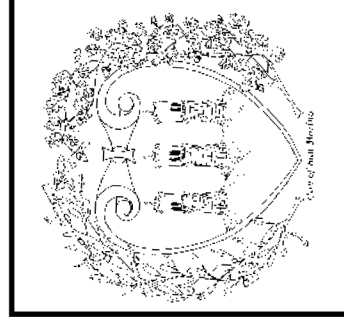
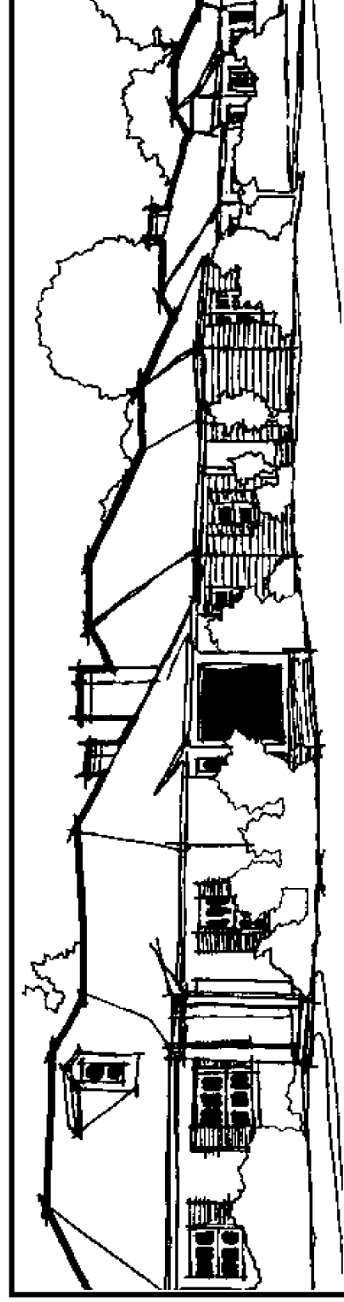
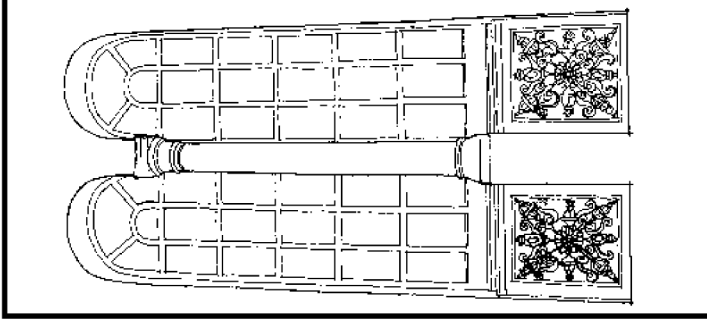
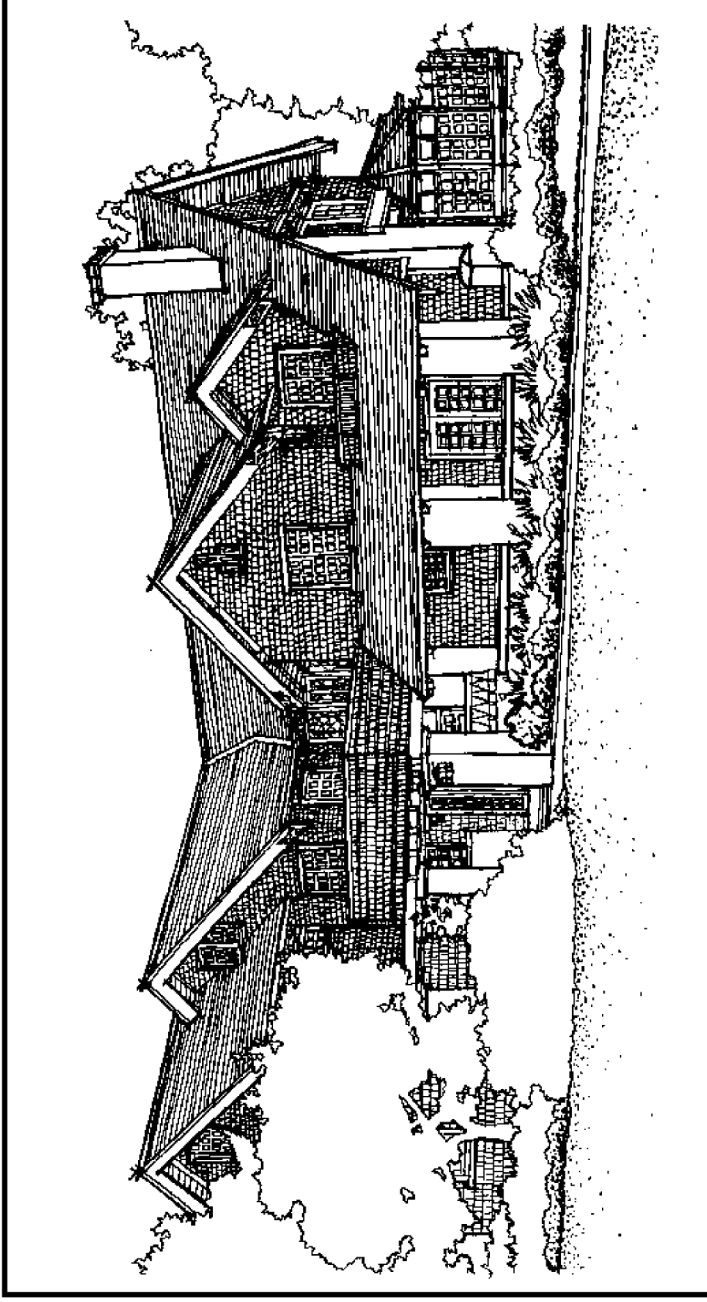

RESIDENTIAL DESIGN GUIDELINES

Final Revision: December 15, 1999

ACKNOWLEDGEMENTS

SAN MARINO CITY COUNCIL

Betty Brown, Mayor
Don Cotton, Vice Mayor
Gene Dryden
Vince Filutze
Emile Bayle

SAN MARINO PLANNING COMMISSION

Chris Datwyler, Chairman
Kenneth Riley, Vice Chairman
John Waddell
Laurie Barlow
Gordon Weaver

SAN MARINO DESIGN REVIEW COMMITTEE

Rich Haserot, Chairman
Susan Berry Brown, Vice Chairman
John Tegtmeyer
Kelly Brimberry
Lee Benuska
Caroline Bragg Vann, Alternate

SAN MARINO CITY STAFF

Debbie Bell, City Manager
David Saldaña, Planning & Building Director
Matthew Ballantyne, Assistant Planner
Brian Boecking, Planning Intern

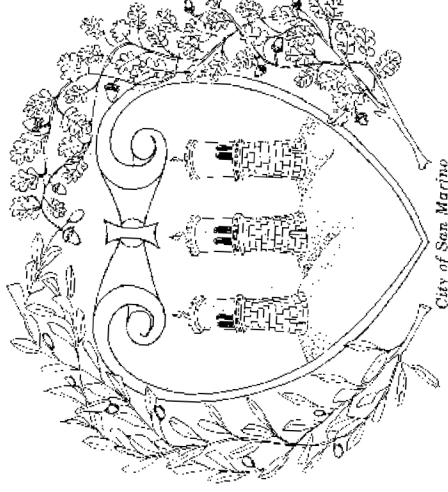

RESIDENTIAL DESIGN GUIDELINES ADVISORY COMMITTEE

Don Cotton, City Council
Laurie Barlow, Planning Commission
Rich Haserot, Design Review Committee
Rosemary Simmons, former mayor
David Saldaña, City Staff
Matthew Ballantyne, City Staff
Brian Boecking, City Staff

SPECIAL THANKS TO:

Rosemary Simmons
Mercury Printing
Cotton/Beland/Associates

Illustrations by Brian Boecking

Council Resolution

RESOLUTION NO. R99-10

A RESOLUTION OF THE CITY COUNCIL OF THE CITY OF SAN MARINO ADOPTING THE SAN MARINO RESIDENTIAL DESIGN GUIDELINES

NOW, THEREFORE, BE IT RESOLVED by the City Council of the City of San Marino as follows:

SECTION 1. In an effort to facilitate the communication of the City of San Marino's residential design policy to the public, the City Council requested the creation of the San Marino Residential Design Guidelines.

SECTION 2. The San Marino Residential Design Guidelines were created by a working committee consisting of one Councilmember, one Planning Commissioner, one Design Review Committee member, a Resident, and City staff.

SECTION 3. The working committee drafted a set of Residential Design Guidelines "to provide a clear concise summary of the City's design policies for projects within the City's residential neighborhoods. The written and graphic illustrations in these guidelines are intended to provide a visual concept and understanding of the City's unique residential characteristics, and to promote architectural design which will enhance the City's established neighborhoods. These guidelines are not intended to limit creative design solutions that are consistent within the stated goals.

SECTION 4. The San Marino Residential Design Guidelines are not intended to be legally required development standards but rather a document reflecting the City's desired design policies. They are to provide architectural guidance and recommendations. It is the City's goal to encourage development consistent with these Guidelines.

SECTION 5. The San Marino Residential Design Guidelines when used in concert with Chapter 23 (Zoning) of the San Marino City Code will assist with the appropriate physical development of residential zoned properties in the City.

SECTION 6. The San Marino Residential Design Guidelines will be an invaluable tool to be used by the Planning Commission, Design Review Committee, and City staff when processing residential development projects.

SECTION 7. Following the opportunity to receive comments from the general public, the Planning Commission, Design Review Committee, and City staff, the City Council hereby adopts the San Marino Residential Design Guidelines.

SECTION 8. The City Clerk shall certify to the adoption of this resolution.

CITY OF SAN MARINO RESOLUTION NO. R99-10
PAGE TWO

PASSED, APPROVED, AND ADOPTED this 9th day of June, 1999.

ELIZABETH R. BROWN, MAYOR

ATTEST:

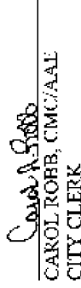
CAROL ROBB, CMC/AE
CITY CLERK

I HEREBY CERTIFY that the foregoing Resolution No. R99-10 was adopted by the City Council of the City of San Marino at a Regular Meeting of the City Council held on the 9th day of June, 1999, by the following vote:

AYES: COUNCILMEMBERS BAYLE, DRYDEN, FULTZE, VICE MAYOR
COTTON, AND MAYOR BROWN.

NOES: NONE.

ABSENT: NONE.



CAROL A. ROBB, CMC/AE
CITY CLERK

TABLE OF CONTENTS

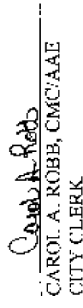

	INTRODUCTION	1		C. Physical Design Components	25
	Purpose	1	1.	Mass and Scale	26
	Location and History	1	a.	Building Volume	26
	Goals	3	b.	Height and Roof Lines	27
	Organization and Contents	3	c.	Facade Treatment	28
			d.	Front Entries	29
			e.	Integrity of Architectural Details	30
	ADMINISTRATION	4	2.	Windows and Doors	31
	Design Review Process	6	a.	Window Awnings	33
			3.	Integrity of Building Materials, Color, and Texture	33
	DESIGN GUIDELINES	7	4.	Roof Treatment	34
	A. Neighborhood Compatibility	7	a.	Chimneys	36
	1. Architectural Style and Design	8	b.	Skylights	36
	a. Architectural Consistency and Compatibility	14	c.	Dormers	37
	2. Streetscape Compatibility	16	5.	Accessory Lighting	37
	a. Scale and Mass	16	D.	Landscaping	38
	b. Setbacks	17	1.	Basic Landscape Principles	38
	c. Good Neighbor Considerations	17	2.	Preservation of Existing Trees	39
	B. Site Development	18	3.	Architectural Consistency and Compatibility	39
	1. Site Plan Considerations	18	4.	Driveways and Walkways	40
	a. Additions and New Accessory Buildings	19	5.	Fences, Walls, Gates and Hedges	41
	b. New Homes	22	6.	Landscape Accessories	43
	2. Environmental Considerations	23	a.	Pools, Fountains, Statuary and Pilasters	43
	a. Sun and Shade, Heating and Cooling	23	b.	Mailboxes and House Address Numbers	44
	b. Impervious Coverage and Landscape Areas	24	7.	Tennis Courts	44
	c. Sustainable Building Materials	24	8.	Landscape Lighting	45
	d. Economies of Scale	24			

TABLE OF CONTENTS Cont'd



APPENDICES:

Appendix A:	Glossary of Terms.....	47
Appendix B:	Obtaining Design and Construction Assistance.....	57
Appendix C:	Information Resource List.....	59
Appendix D:	Building Project Check List.....	61

RESIDENTIAL DESIGN GUIDELINES



INTRODUCTION

PURPOSE

The purpose of these design guidelines is to provide a clear concise summary of the City's design policies for projects within the City's residential neighborhoods.

The written and graphic illustrations in these guidelines are intended to provide a visual concept and understanding of the City's unique residential characteristics, and to promote architectural design which will enhance the City's established neighborhoods.

These guidelines will aid toward preserving neighborhood character and protecting property values.

Residential property owners, developers, architects, building designers, and contractors seeking to construct new residential structures or alterations and additions to existing structures should use these guidelines in the early design stages of their projects. This document should be used to obtain guidance for designing a project. Persons seeking specific development standards are directed to look in the San Marino City Code. These guidelines also apply to new roofs or modifications to existing roofing materials and/or front yard fencing and paving. For projects affecting public visibility, information pertaining to front yard landscaping is included. Additionally, the guidelines will stress the importance of tree preservation and the opportunity for creative site planning.

These guidelines are not intended to limit creative design solutions that are consistent with the stated goals.

These guidelines will be used by the Planning Commission, Design Review Committee and City staff as a basis for evaluation of proposed projects. They are also intended to be used in order to ensure consistency of review between the Design Review Committee, Planning Commission and City Council.

LOCATION AND HISTORY

Since its incorporation in 1913, the City of San Marino has been a community that prides itself on the quality of architecture and mature landscaping that defines its homes. The majority of San Marino, comprising of 3.75 square miles, is zoned for low-density residential use.

Located in the western San Gabriel Valley, San Marino evolved as a residential area from the original Gabrielino Indians, through the Spanish and Mexican Land Grants and the ranches and vineyards of the early settlers to the city we know today.

The majority of the city's growth and development occurred between the 1920s and 1940s. Well known architects of this era, such as Wallace Neff and Roland Coate, contributed to the rich architectural statements reflected in San Marino's housing stock.

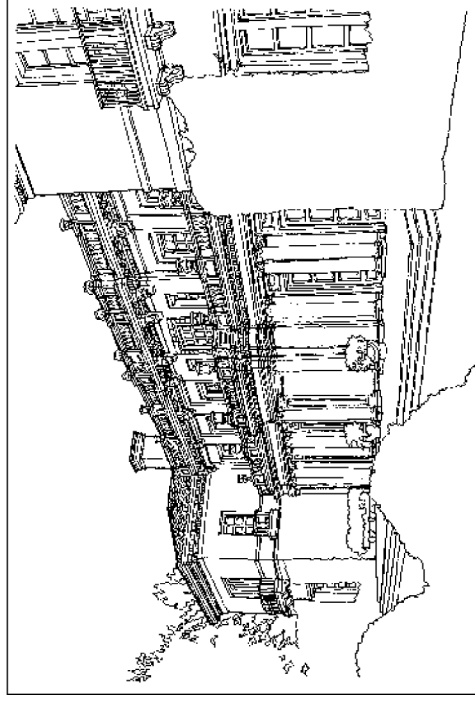

The Main House on the Huntington Estate

The city is renowned for its beautiful homes, which result from the residents' concern about their community and efforts to maintain properties that comply with the city's standards. Their efforts create a city of safe, elegant and prosperous neighborhoods in which to live.

LOCATIONAL MAP OF SAN MARINO

San Marino has a rich tradition of pride in ownership set forth by the first city leaders. They envisioned an architecturally rich, residential community of individually designed houses with mature landscaping and gardens, tree lined streets and expansive green belts promoting a high quality of life for all its residents. This vision is carried on by today's city leaders who strive to preserve that quality of life for San Marino's future residents.

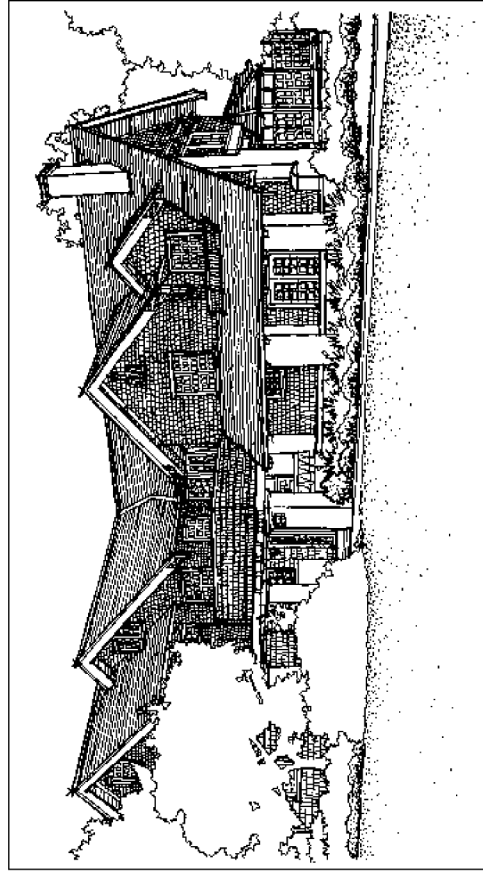
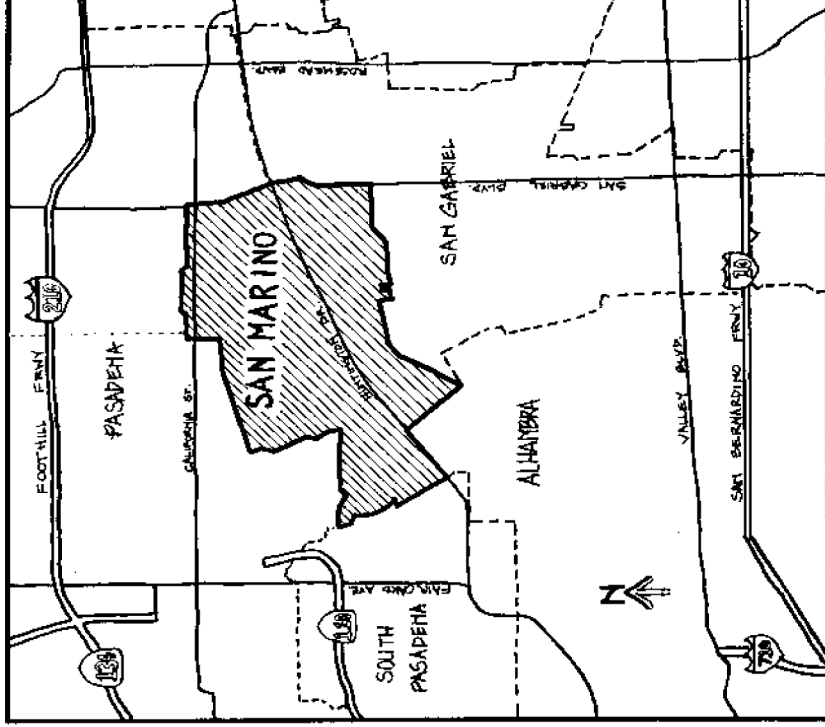

House built by Richard Lacy, for whom Lacy Park is named

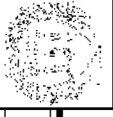

GOALS

The goals of these guidelines are to:

- preserve and reinforce the existing architectural character and identity found within San Marino's residential neighborhoods.
- provide for improved visual quality of proposed structures by relating to surrounding architectural styles, massing, building materials and colors.
- provide for improved visual quality of front yards through the appropriate review of front yard fencing, paving and landscaping.
- provide for the physical enhancement of residential properties in a manner that would protect and preserve property values.
- provide for the flexibility of creative design solutions in a manner sensitive to the surrounding neighborhood.
- encourage environmental sensitivity in development and quality design.

ORGANIZATION AND CONTENTS

For ease of use, the Residential Design Guidelines are presented in four sections:

1. **Neighborhood Compatibility**- This section stresses the importance of designing a project that fits with the established neighborhood's physical character. Basic site and architectural design principles are discussed with an emphasis for the appreciation of surrounding properties.
2. **Site Development**- The appropriate placement of new residences, accessory buildings, or additions to existing residences is covered in this section. Also, this section explains the advantages to utilizing sustainable building materials and incorporating other environmentally sound building practices.
3. **Physical Design Components**- This is the "nuts and bolts" portion of the Residential Design Guidelines. Discussion of mass and scale, window and door details, building materials, colors, texture, and roof treatment are some of the items covered in this section.
4. **Landscaping**- The preservation of trees and open space is stressed in this section. Also covered is policy regarding "hardscaped" areas such as driveways, walkways and tennis courts. The preservation of public views is also mentioned with discussion of front yard fencing.

Finally, the **Appendices** contains a wealth of useful information for anyone using the Residential Design Guidelines. The Appendices include a **Glossary of Terms** used in this document with a definition to provide clarity for the reader; a section on how to pursue **Obtaining Design and Construction Assistance**; an **Information Resource List** to provide ideas regarding where to go and who to see for information and help; and a **Building Project Checklist** to help ensure a successful project.

ADMINISTRATION

Implementation of the residential design guidelines is administered through City Staff, the Design Review Committee (DRC), the Planning Commission and the City Council. (See Chart on Page 6) The members of the DRC and Planning Commission are appointed by the City Council.

Projects which include any addition of floor area to a residence, new homes, modifications to the exterior facade visible from public view, a change of roof material that is not on the city's pre-approved roof materials list, and all front yard fences, walls, and gates are reviewed by the Design Review Committee. The DRC meets twice a month. The application process for the DRC is approximately three to five weeks.

Design review by the Planning Commission is incorporated simultaneously with the variance and/or conditional use permit process in accordance with the San Marino City Code. The Planning Commission meets once a month. The application process for the Planning Commission is approximately six to eight weeks. City Staff prepares staff reports for all Planning Commission applications.

What Happens In Design Review? In design review, exterior projects are evaluated for architectural compatibility with the neighborhood.

At the public hearing, members of the Design Review Committee or Planning Commission will discuss the project with the applicant. Prior to the discussion at the Planning Commission meeting, City staff will present a brief report making a recommendation. Members of the community are given an opportunity to speak about the proposed project. The project will either be approved, approved with conditions, denied, or continued to a future date for a redesign.

What Requires Design Review?

Generally, the following projects require design review:

- All new residences and certain accessory structures;
- Most one-story residential additions and all two-story additions;
- Any change to an exterior facade visible from public view;
- Placement of walls, fences, pilasters or gates in a front, side, or rear yard adjacent to a public street;
- Re-roofing a residential structure with a material not on the pre-approved roof materials list.

To be certain if the project would require design review, please contact the Planning and Building Department or refer to Section 23.15.03 of the City Code.

What Are The Steps To Follow? First, the applicant should review the design guidelines and the City Code Sections that affect the proposed project. Then, a meeting should be scheduled with City staff to discuss ideas and ask questions.

Second, the applicant should decide if someone is needed with design skills and background to prepare drawings. This may seem an added expense, however, getting professional design help can save a great deal of time in completing the design review process. Saving time in development is often

RESIDENTIAL DESIGN GUIDELINES



as valuable as saving money.

Third, as the applicant develops his/her design and drawings, they should keep in contact with City staff. All design decisions at this stage are the applicant's to make. However, if the applicant has questions, this is the best time to get answers, not after the design is completed.

Fourth, if the proposed project requires design review, the applicant will need to submit the following:

- A completed application.
- Any applicable fees.
- Liveable Area and Ground Coverage calculations.
- One set of plans.

City staff will then review the plans to make sure that they meet City Code requirements. They will notify the applicant by letter of any revisions that need to be made. After review of the proposal, the following will be requested:

- The required number of plans (fan folded with project address clearly visible).
- The required number of manufacturer's brochures of any proposed new roof material, skylight, windows, doors, light fixtures, etc.
- Color and Materials board if applicable.

- Evidence showing reasonable steps to notify and present proposed development plans to property owners in the neighborhood. These forms used for this procedure are called "Neighborhood Notification Letters". Neighborhood Notification Letter forms are available in the Planning and Building Department. Planning staff can be of assistance in determining the neighbors required to be notified.

- Addressed and stamped envelopes for the applicant, their agent (if any), and property owners in the neighborhood as specified in the City Code.
- Any other materials required by staff (check with the Planning and Building Department)

At the public hearing, either the property owner or his/her representative must be present to answer any questions that the DRC Members or Planning Commissioners may have. At this time the applicant will know if the project is approved, approved with conditions, denied, or continued to a specific date.

When is the Design Review Process Completed? When the DRC Commission approves the proposed construction plans, required conditions have been implemented into the working drawings and proper permits have been obtained, the project is finished with the design review process. After the DRC or Planning Commission has approved a project, there is a fifteen day appeal period in which any individual may appeal their decision. After this appeal period, the applicant may submit for plan check (if needed) and obtain necessary building permits.

RESIDENTIAL DESIGN GUIDELINES

DESIGN REVIEW PROCESS:

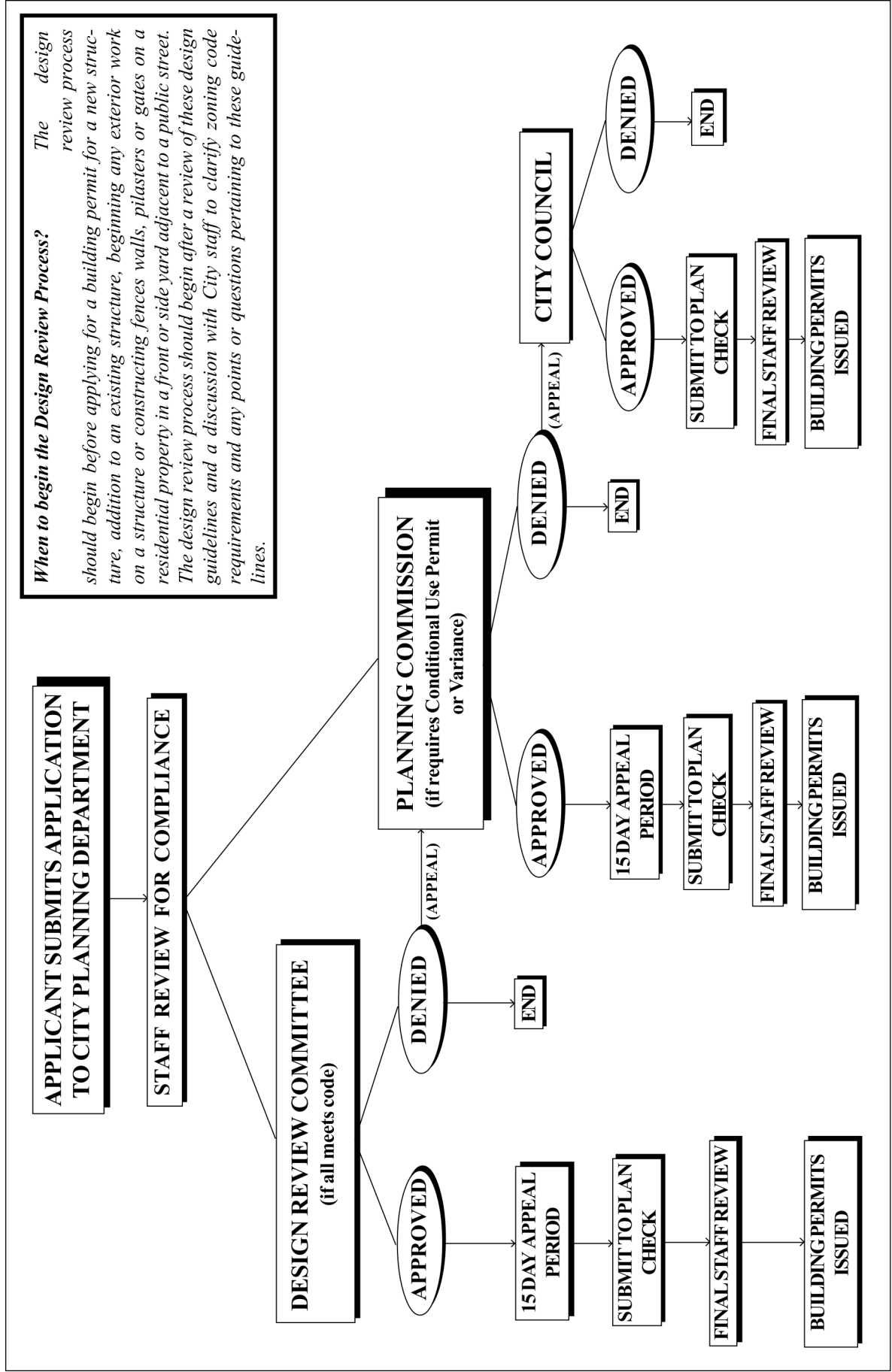

When to begin the Design Review Process?

The design review process should begin before applying for a building permit for a new structure, addition to an existing structure, beginning any exterior work on a structure or constructing fences walls, pilasters or gates on a residential property in a front or side yard adjacent to a public street. The design review process should begin after a review of these design guidelines and a discussion with City staff to clarify zoning code requirements and any points or questions pertaining to these guidelines.

RESIDENTIAL DESIGN GUIDELINES

DESIGN GUIDELINES

These design guidelines apply to all new buildings, exterior remodels, and additions within the city's residential neighborhoods. These are recommendations for the architectural treatment and organization of buildings and open space, and are suggested criteria for reviewing projects during the design review process.

A. NEIGHBORHOOD COMPATIBILITY

“The external image a city presents to the world is the signature by which it is known.”
- Richard Hedman, American Planning Association

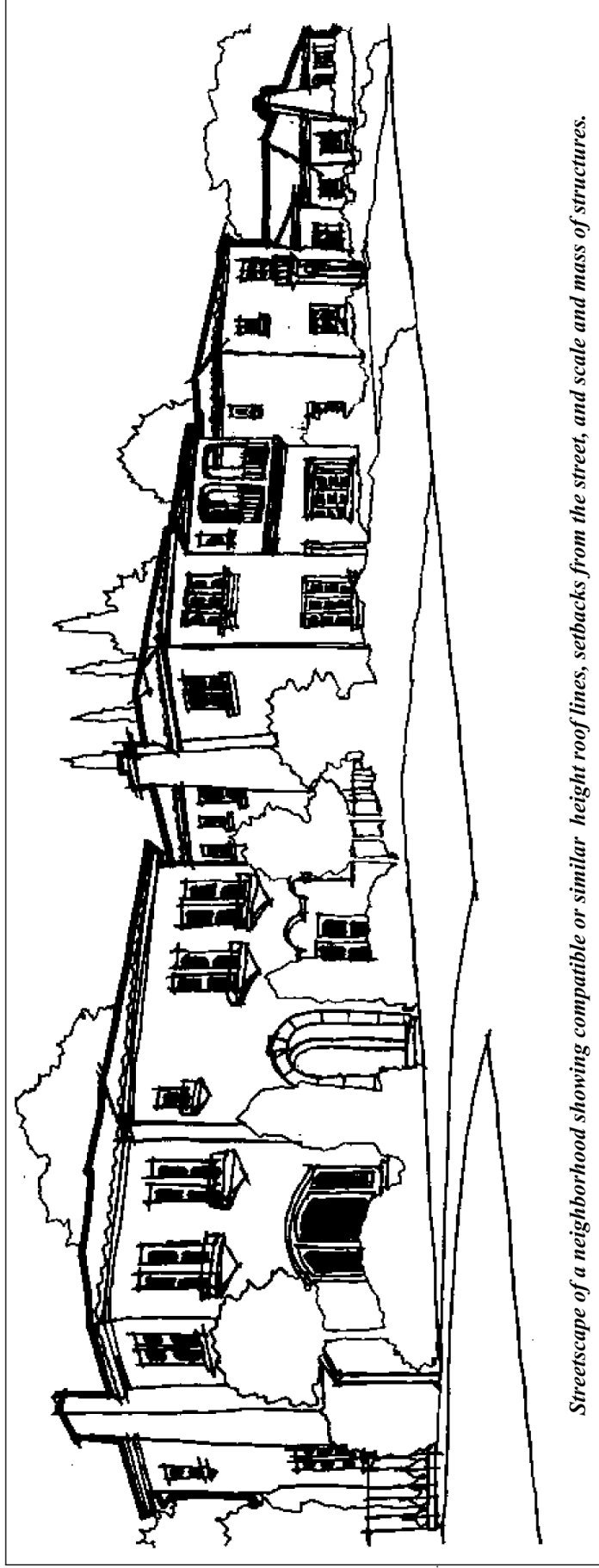

Streetscape of a neighborhood showing compatible or similar height roof lines, setbacks from the street, and scale and mass of structures.

The key to a successful residential project in San Marino is to assure its compatibility with the surrounding homes in the neighborhood. What is compatibility? The City Code defines it as follows:

“Having an architectural style, visual bulk, massiveness, height, width and length which is compatible with the neighborhood and which harmonizes with the existing residential or commercial structures in the neighborhood and, in the case of a building addition, with the existing building.”

Compatibility could also include such terms as *scale, orientation, setback, relationship to site contours*, and architectural elements such as *texture, color, and building materials*.

Every neighborhood has a defined character based upon some or all of the above factors. Its identity should be maintained by designing a project that complements its surroundings. Some neighborhoods are characterized by broadly landscaped and open front yards. Others have large elegant homes

RESIDENTIAL DESIGN GUIDELINES

with deep front yard setbacks. Some neighborhoods have an abundance of Mediterranean style architecture on smaller lots with narrow side yards, yet others are one-story, and contemporary in appearance with a lack of sidewalks, and/or street trees.

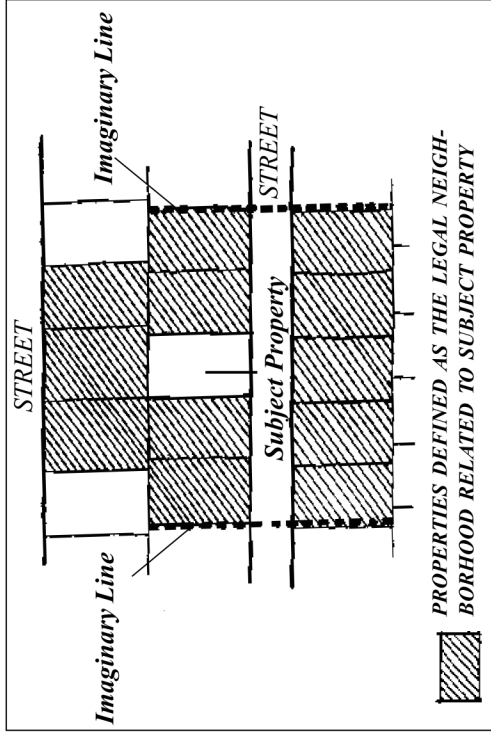

Legally Defined "Neighborhood"

How is a neighborhood defined for design review purposes? The City Code defines it as follows:

"a) The two (2) properties on each side of the lot; b) all properties adjoining the rear of the lot and each property on either side of the adjoining property(ies); c) extending the lot's property line across the street, all property(ies) across the street within the parameters of the extension and the property on either side of those properties. For houses at the end of a cul-de-sac street, all property(ies) adjoining the rear of the lot, each property on either side of those adjoining property(ies) and the three (3) properties extending from each side of the lot."

A neighborhood has "character of place" defined by a local grouping of scale, orientation, landscape, and structure placement. The established character of a neighborhood should be reinforced and complemented, not negated or intruded upon by inappropriate construction.

Compatibility primarily emphasizes architectural style. The emphasis is on expansive, horizontal gestures with natural materials. Roof forms are handled simply and consistently, and tend not to be "boxy". Styles run to the traditional interpretations, and colors are generally muted. Most neighborhoods tend to have a very quiet elegance and front yards are designed to not obscure visibility of the main residence from public view.

Although San Marino tends to encourage the retention of traditional architecture, applicants should not restrict themselves from displaying the flexibility of good design principles. Occasionally, older neighborhoods have one or more homes that reflect contemporary architectural elements. This is an opportunity to design a project that may contain key architectural elements that reflect current thought.

Project applicants should not assume that a project will be approved merely by adhering to the City's minimum zoning and development regulations (i.e., setbacks, lot coverage, liveable area, etc.). The City's zoning regulations apply to a broad area known as Area Districts. Property and neighborhood development characteristics vary within each Area District. In reviewing applications compatibility determination is based on the neighborhood as defined by the City Code.

- 1. Architectural Style and Design:** The following architectural styles are illustrated and described to clarify styles commonly seen in San Marino. They are not mentioned to exclude or inhibit other architectural styles from being proposed for new projects. This listing of styles is intended to encourage design that promotes an appreciation of traditional architectural elements. These styles include, but are not limited to:
- Spanish Colonial Revival
 - Mediterranean/Italian Renaissance
 - Monterey Period Revival
 - Ranch House
 - Minimal Traditional
 - Neoclassical
 - Tudor
 - Colonial Revival
 - Cape Cod



Spanish Colonial Revival

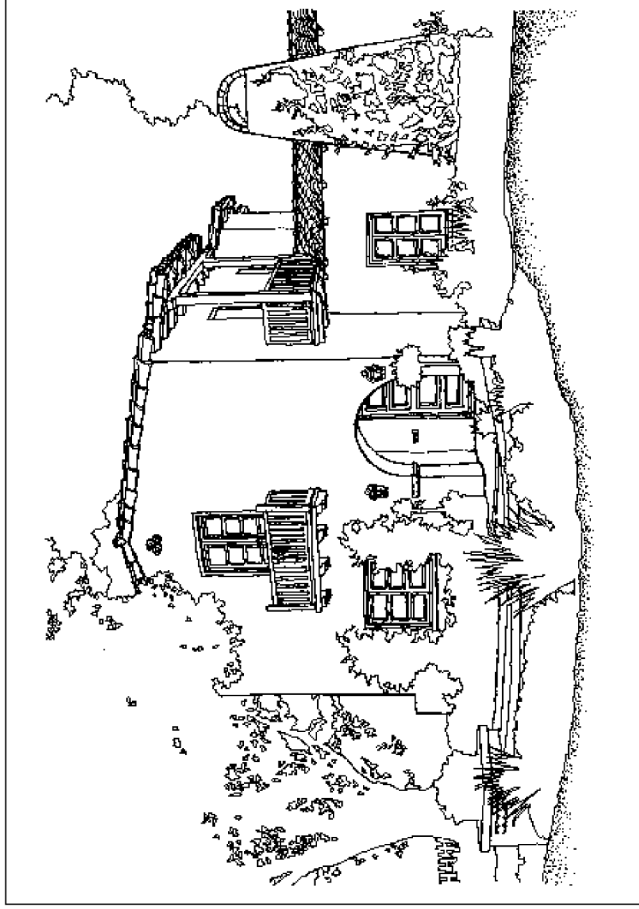

Character Defining Features

- one to one and a half stories
- flat roof with red tile parapet cap or low-pitched gable roof with little or no overhang
- stucco siding
- arched window and porch openings (semicircular, elliptical, or segmental)
- large focal window on front facade
- wing wall at one corner
- indoor-outdoor continuity: patios and terraces

Mediterranean/Italian Renaissance

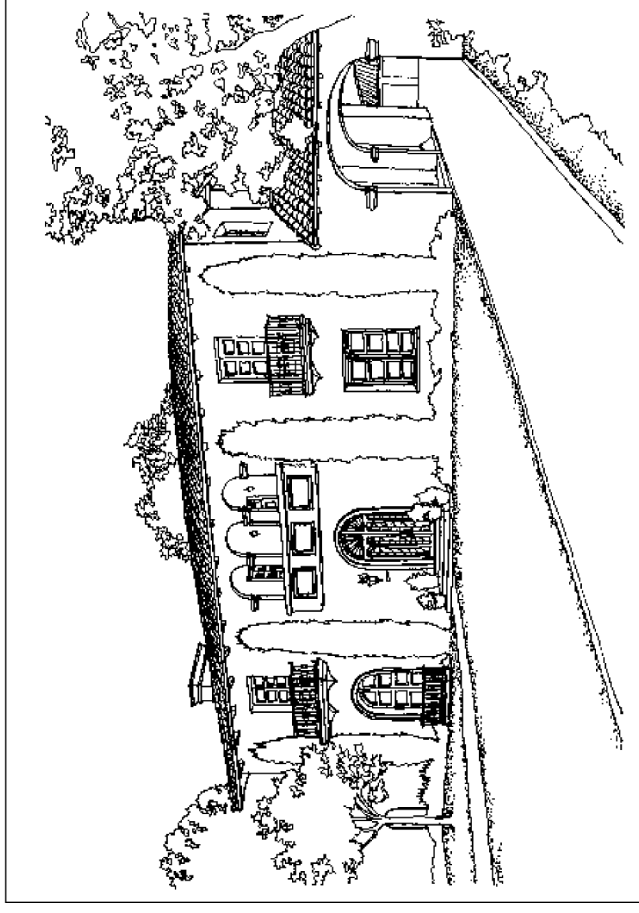

Character Defining Features

- low-pitched hipped roof (flat in some examples)
- roof typically covered by ceramic tiles
- upper-story windows smaller and less elaborate than windows below
- first-story windows, doors or porches commonly with arches above them
- entrance area usually accented by small classical columns or pilasters
- facade commonly symmetrical

Monterey Period Revival

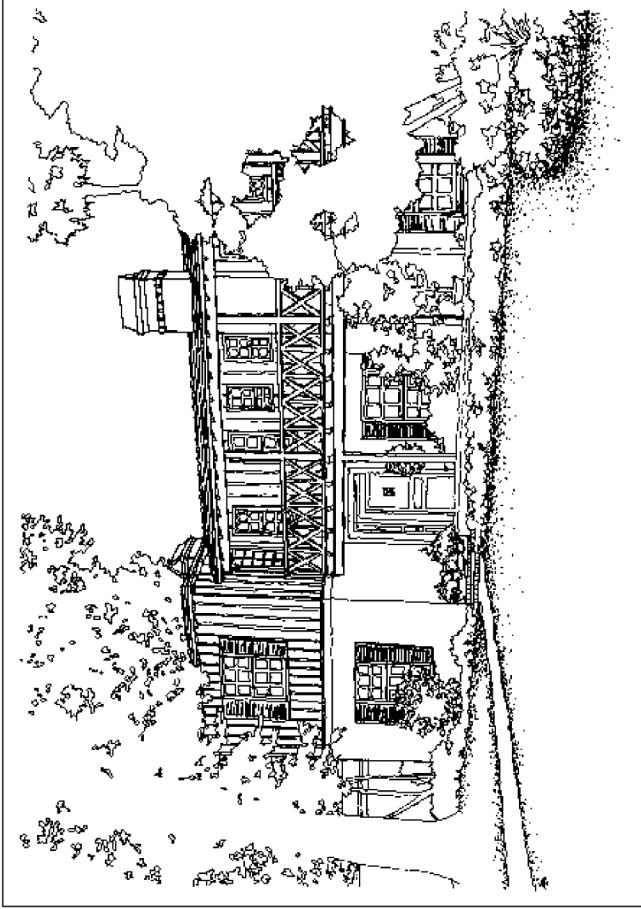

Character Defining Features

- two story
- low-pitched gabled roof (occasionally hipped)
- second-story balcony (usually cantilevered) and covered by principal roof
- tile or shingle roof material
- stucco finish, occasionally with wood siding for accent
- multi-paned windows, often with false shutters
- large, massive chimneys

Colonial Revival

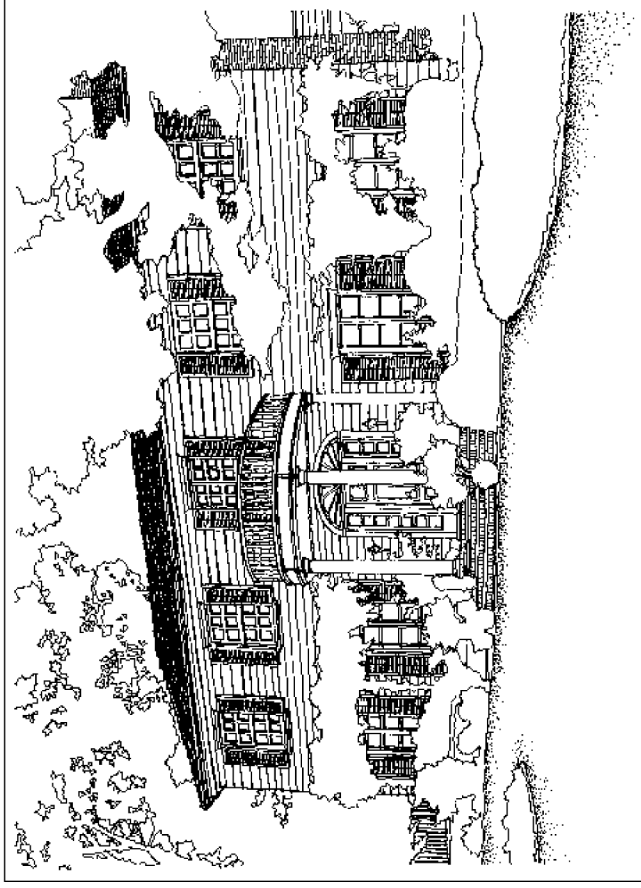

Character Defining Features

- one or two story
- gable or hipped roof
- symmetrical facades
- narrow clapboard siding
- Greek and Roman architectural details
- wide fascia boards
- hipped dormer (central)
- classical prominent porch, sometimes with pediment
- square or rounded columns with simple capitals
- rectangular, three-part windows



Neoclassical

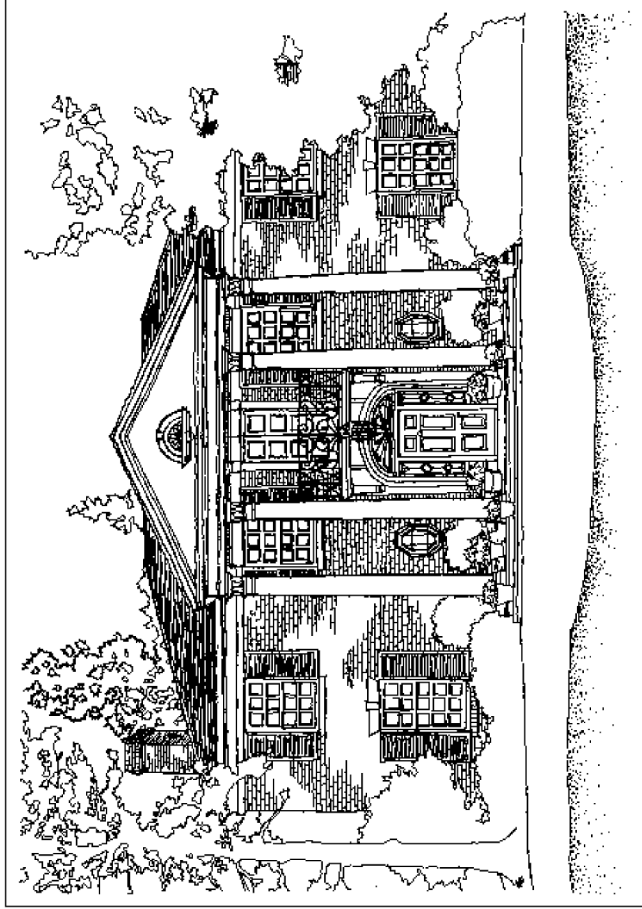

Character Defining Features

- facade dominated by full-height porch with roof supported by classical columns
- columns typically have Ionic or Corinthian capitals
- facade shows symmetrically balanced windows and center door
- red brick exterior walls
- double-hung windows
- extensive use of shutters

Tudor

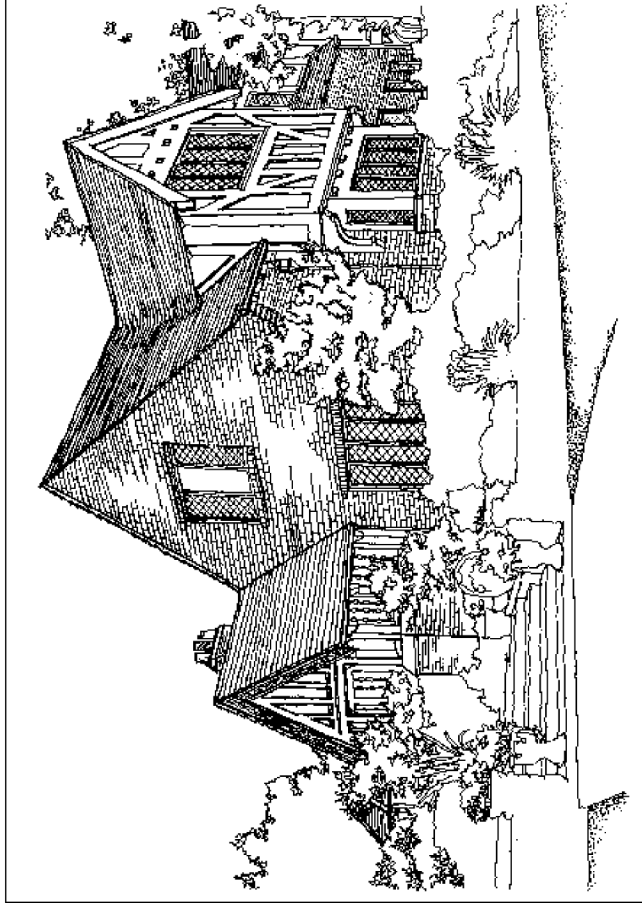

Character Defining Features

- steeply pitched roof, side-gabled
- slate or shake roofing
- facade dominated by one or more prominent cross gables, usually steeply pitched
- decorative half-timbering
- tall, narrow windows, usually in multiple groups and with multi-pane glazing
- massive chimneys, commonly crowned by decorative chimney pots
- clinker brick

RESIDENTIAL DESIGN GUIDELINES

Ranch House

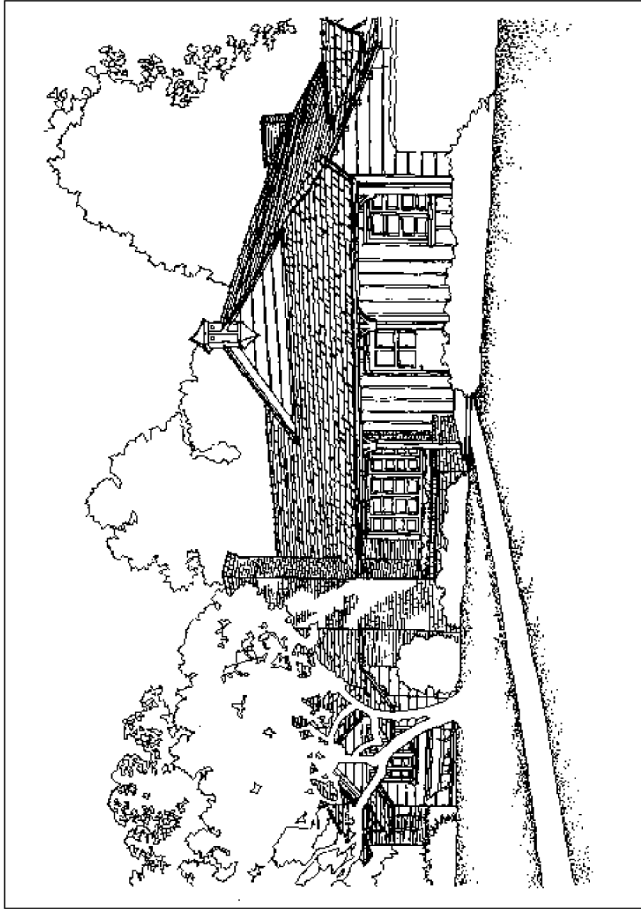

Character Defining Features

- low-pitch, gable, shake roof with large overhang
- one story, rambling, informal floor plan
- attached garage integrated into the design
- easy indoor-outdoor access
- asymmetrical
- wooden and brick wall cladding are used, sometimes in combination
- decorative iron or wooden porch supports and decorative shutters are common
- decorative cupolas

Cape Cod

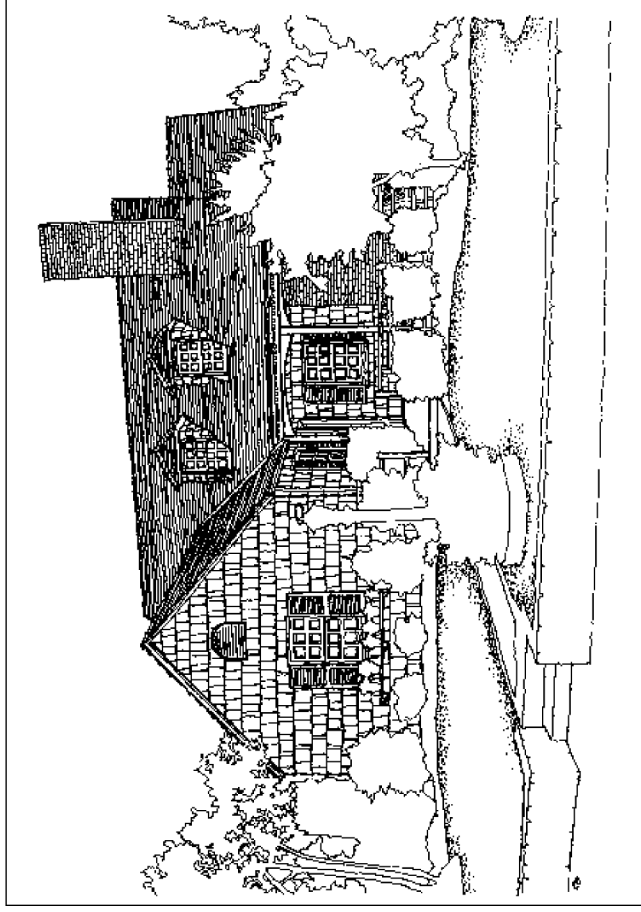

Character Defining Features

- high roof pitches with/without dormers
- wood shake roof material
- dominant cornice molding below eaves
- at least one front-facing gable
- one to two stories
- exterior facade of large, heavy, dark wood shingles
- brick chimneys



Minimal Traditional

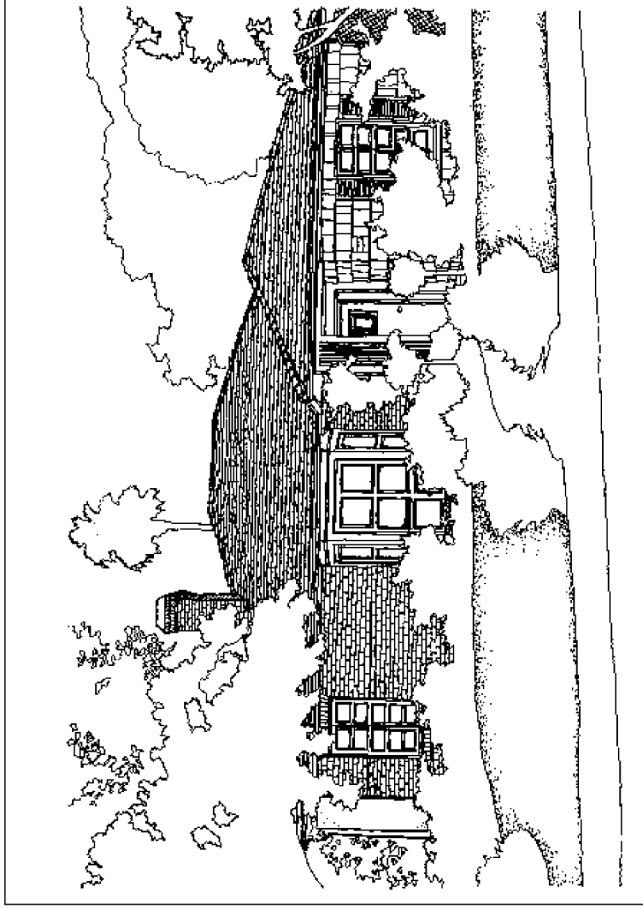

Other styles that are seen in San Marino and are encouraged are;

- Victorian
- Craftsman Bungalow and Chalet
- Beaux Arts
- Dutch Colonial Revival
- French Eclectic
- Prairie
- Arts and Craft
- Modernistic
- International

The common “developer tract” styles are not authentic and are discouraged, particularly since they rely on “curb appeal” architectural features, attached to a “box”. They also emphasize garages as a prominent architectural portion of the facade. This is contrary to development patterns found in San Marino.

All architectural styles are encouraged to be researched so that they can be appropriately represented before projects are submitted to staff, the Design Review Committee and Planning Commission.

Please see Appendix C for a listing of resources where these architectural styles as well as various others can be researched.

Character Defining Features

- low or intermediate roof pitches
- closed eaves and rake
- large chimney and at least one front-facing gable or hip
- one to two stories
- representative examples of the traditional eclectic styles of Colonial Revival or Monterey

RESIDENTIAL DESIGN GUIDELINES

a. Architectural Consistency and Compatibility:

Diverse architectural styles are represented in nearly all of San Marino's neighborhoods. Most of the housing stock was developed between the 1920's and 1940's. Homes were designed by such notable architects as Wallace Neff, George Washington Smith, Roland Coate, and Paul Williams. Many homes have an architectural style reminiscent of that found elsewhere in the United States. Others retain mediterranean or ranch styles more in keeping with that found in the southwestern United States.

New homes should incorporate a specific architectural style compatible with those found on other homes in the neighborhood. This is not meant to inhibit the use of design flexibility. Any architectural style is acceptable provided it "fits" into the neighborhood. Homes of traditional architectural styles should incorporate traditional elements of design. For example, a Craftsman home should have wood framed rather than aluminum framed windows; broad eaves with rafter tails rather than not; wood siding rather than stucco; porches rather than not; and detached rather than attached garages.

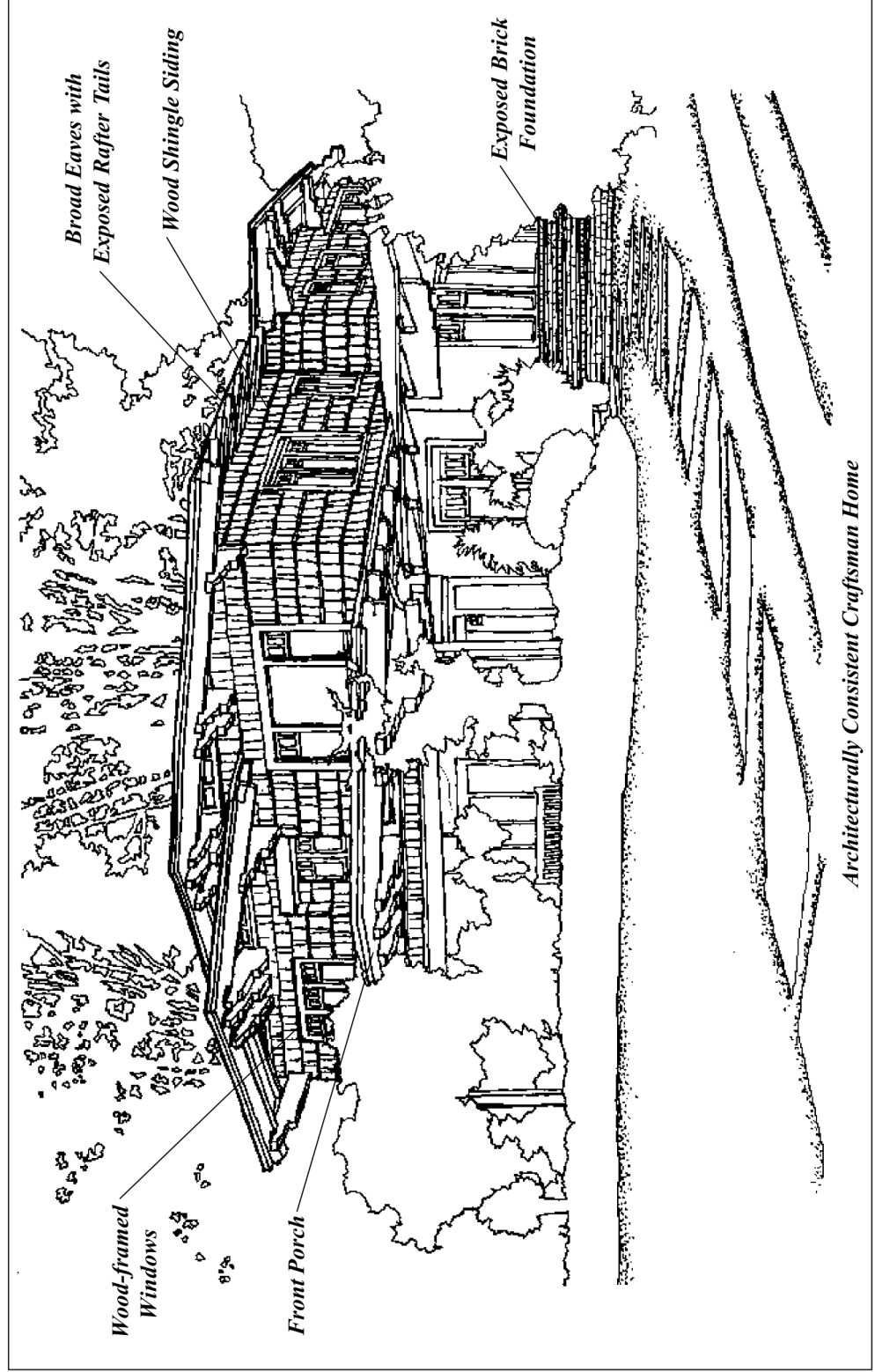

Architecturally Consistent Craftsman Home

RESIDENTIAL DESIGN GUIDELINES

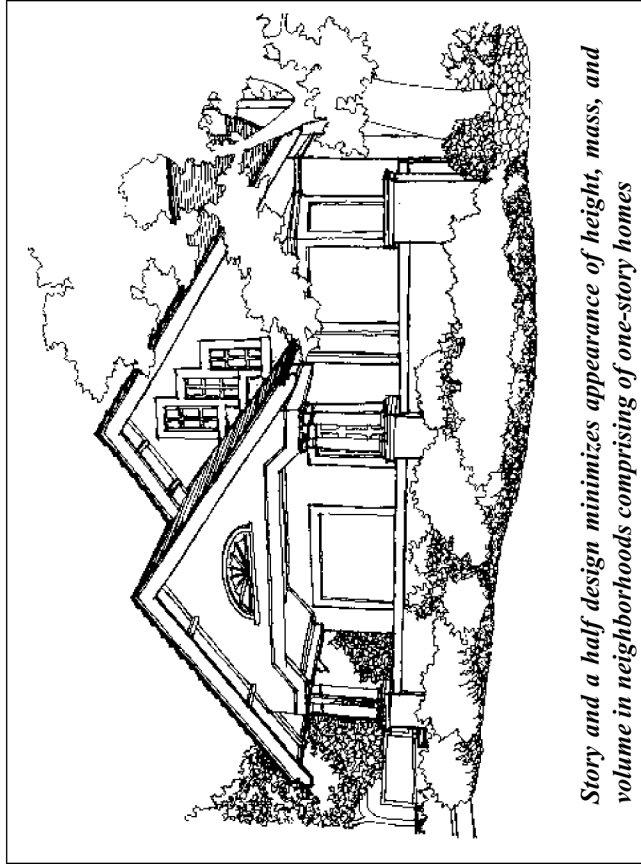

Story and a half design minimizes appearance of height, mass, and volume in neighborhoods comprising of one-story homes

Additions should be integrated with the existing house so that it appears to have always existed. The shape and proportions, overall massing, roof slope, exterior materials and colors, even the types of windows will contribute to the success of an addition or alteration. This can be accomplished much easier for one-story additions. Two-story additions should be carefully designed to eliminate having a “pop-up” appearance from public view. A second-story addition should be carefully integrated to appear like it was part of the original house. If too tall, small, large, or placed at the rear of the house, it will result in a “pop-up” design.

Long, uninterrupted side walls should be avoided. Second stories should be setback further from the side property line than the first floor. Materials and finishes of an addition or alteration should be consistent and continuous with the original house.

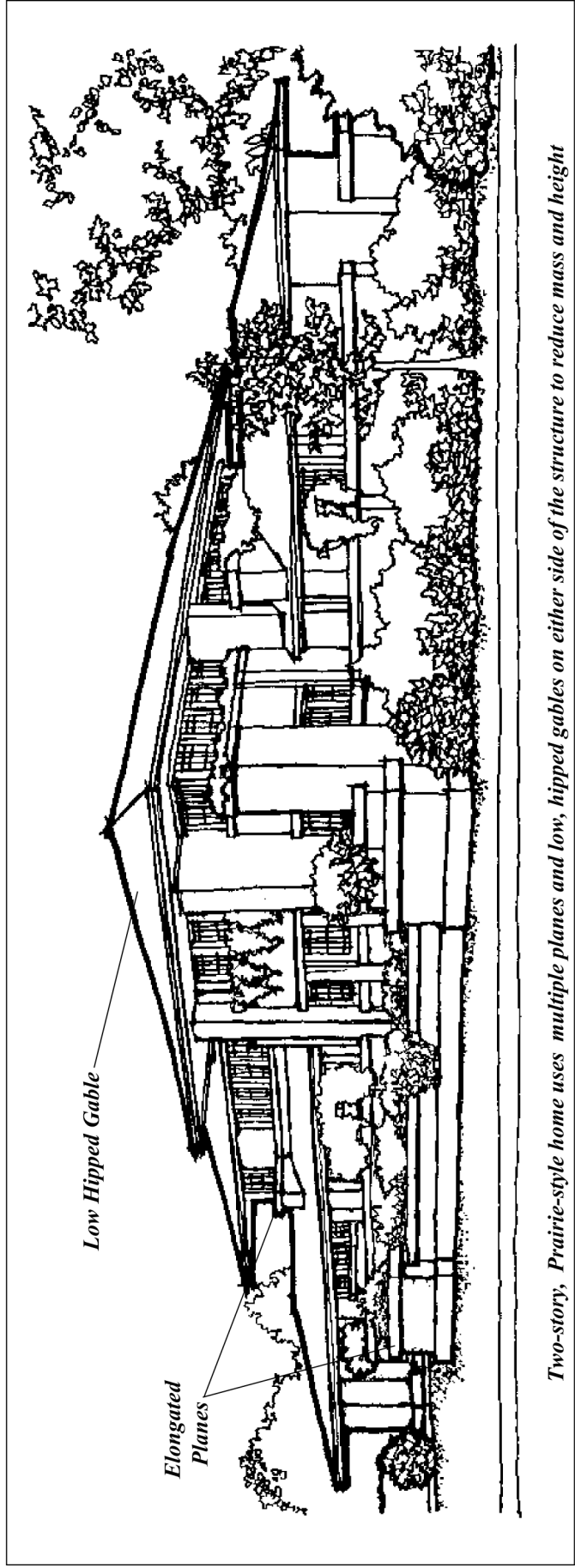

Two-story, Prairie-style home uses multiple planes and low, hipped gables on either side of the structure to reduce mass and height

RESIDENTIAL DESIGN GUIDELINES

Architecturally Consistent Addition

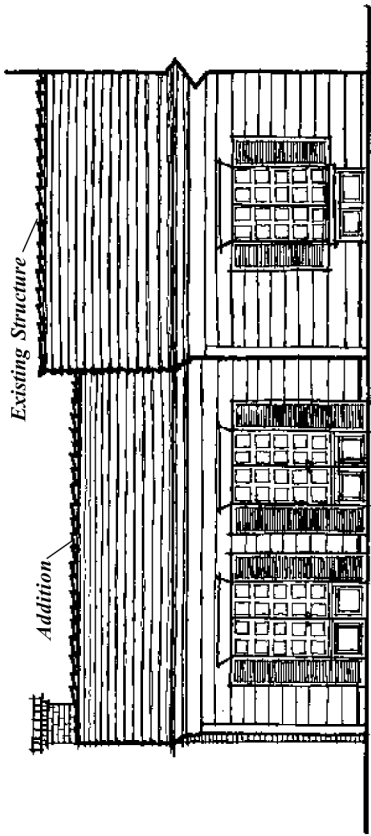

Architectural elements (windows/doors, wood siding, roof material, and pitch) of addition are compatible to the existing structure

2. Streetscape Compatibility: What is Streetscape? It represents the appearance of a developed property as viewed from a public street. It incorporates all that can be seen to include structural setbacks, structural mass and height, roof forms, facades, entry locations, porches and other architectural features, garages, fences, walls, hardscape and landscaping.

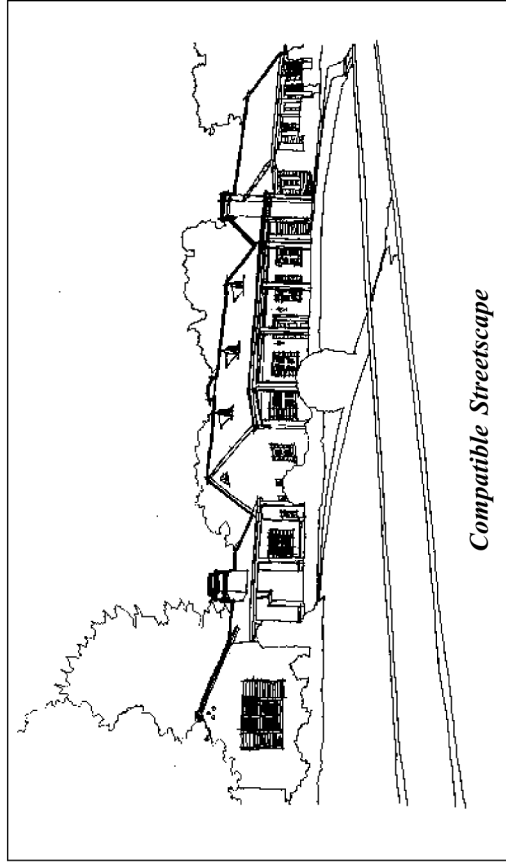

Compatible Streetscape

defines its character. These patterns are well established in San Marino neighborhoods. The stronger the established pattern, the more important it is to maintain the character of the neighborhood by respecting these patterns.

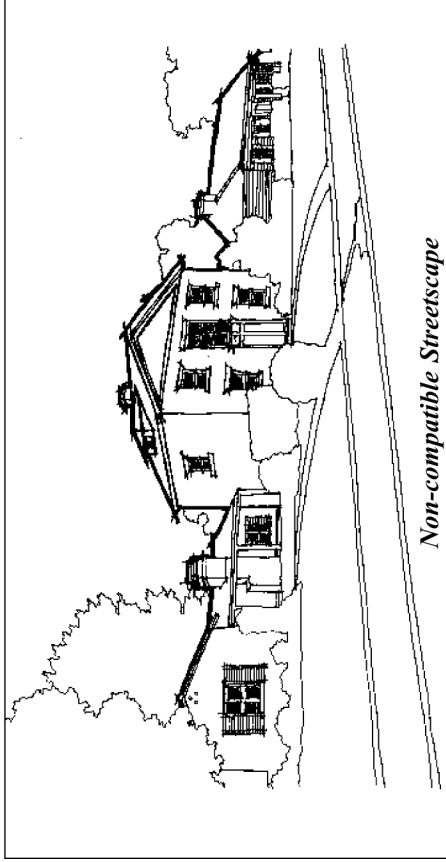

Non-compatible Streetscape

a. Scale and Mass: The mass and height of a new building should blend well with neighboring structures and not overwhelm them with disproportionate size or a design that

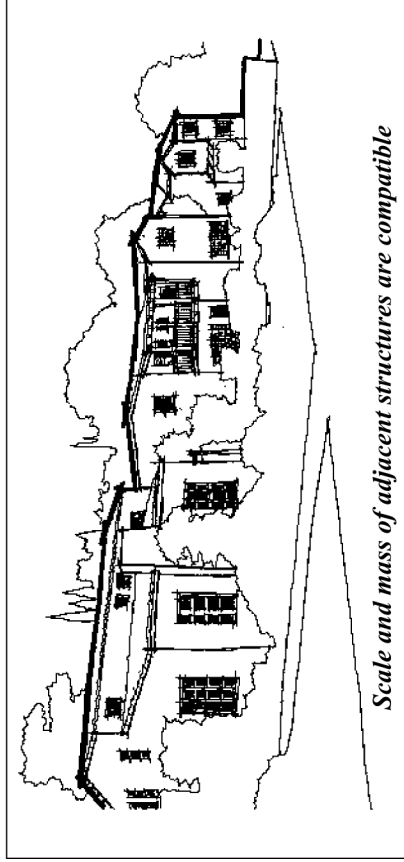

Scale and mass of adjacent structures are compatible

is out of character. A two-story structure should not be constructed in a one-story neighborhood unless it is carefully designed to be similar in scale and mass with surrounding structures.

Each neighborhood has an established observable streetscape pattern that

RESIDENTIAL DESIGN GUIDELINES

b. Setbacks: New structures should observe established front and side yard setbacks in a neighborhood. In many blocks, building fronts align. The established pattern should be followed for new house placement even if it is more restrictive than the Zoning Code. The same is true for side yard setbacks. A building that doesn't follow an established setback pattern may be disruptive to the character of the neighborhood. Follow the prevalent pattern of setbacks to help unify the neighborhood.

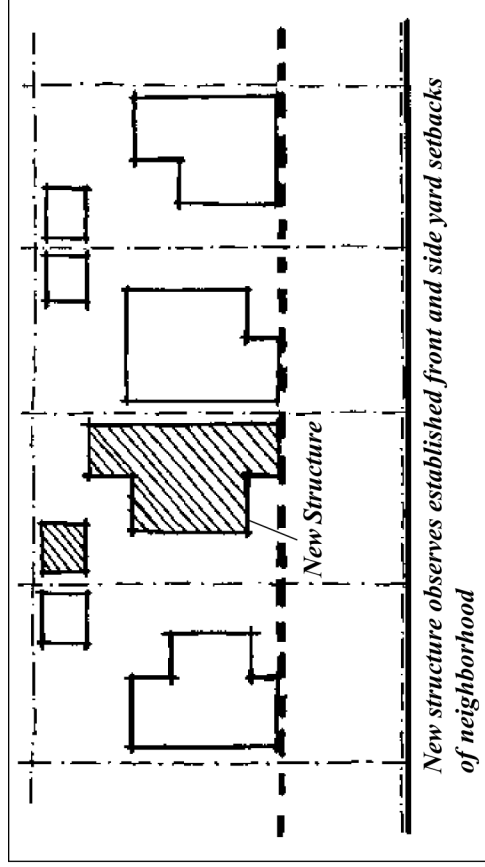

c. Good Neighbor Considerations: Minimize the visual impact of a new building and related architectural features on adjacent properties. Attempt to locate taller sections of buildings where they will not obstruct sunlight to adjacent gardens, patios, pools, or rooms. Second floor balconies and decks should be designed and located to minimize the loss of privacy for neighboring properties. Try to place new windows where they will promote privacy between properties. For example, windows can be placed high on a wall where natural light and ventilation is obtained without providing a view to adjacent property. Also, landscaping can be incorporated into a design to provide privacy screens between neighbors. Try to

preserve a portion of a neighbor's view by carefully positioning or limiting the width, depth, or height of proposed building elements. Observing these considerations will greatly aid in the design review process and the success of the overall project

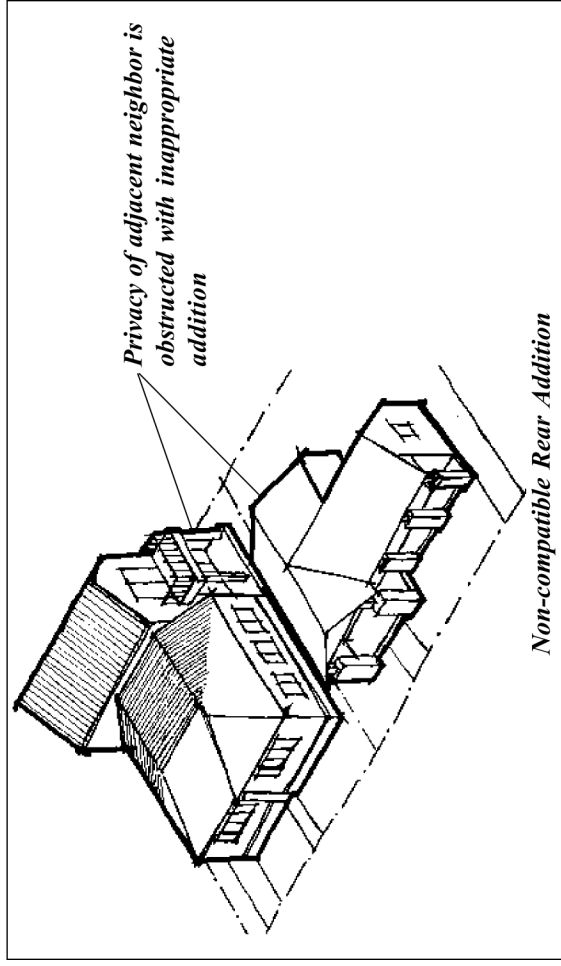
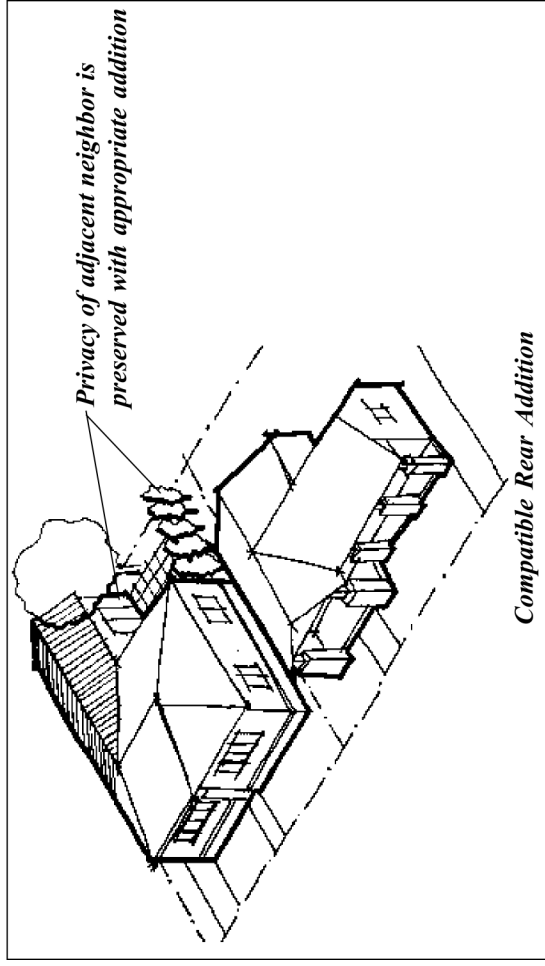



RESIDENTIAL DESIGN GUIDELINES

B. SITE DEVELOPMENT

*“Architecture should be a grace to the landscape, not a disgrace.”
- Frank Lloyd Wright*

1. Site Plan Considerations: How well a building fits with its site contributes to the success of a project. All forms of development including additions, new accessory buildings and new homes should first take into account the site on which the structure will be built. Effective site planning should reflect the natural attributes of the site, while maintaining compatibility with the neighborhood. The following are general guidelines for site development:

- A building should be designed to be compatible with the natural slope of the land, adapting to the land and reflecting its contours, while respecting all significant, existing trees and vegetation and any other natural site attributes.
- Building setbacks should be established that reflect the natural

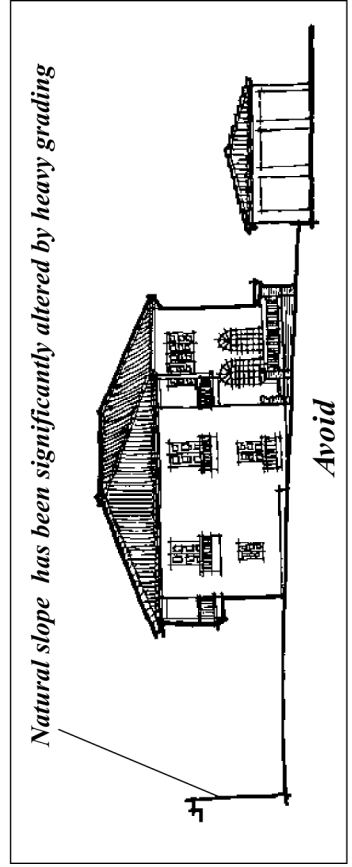
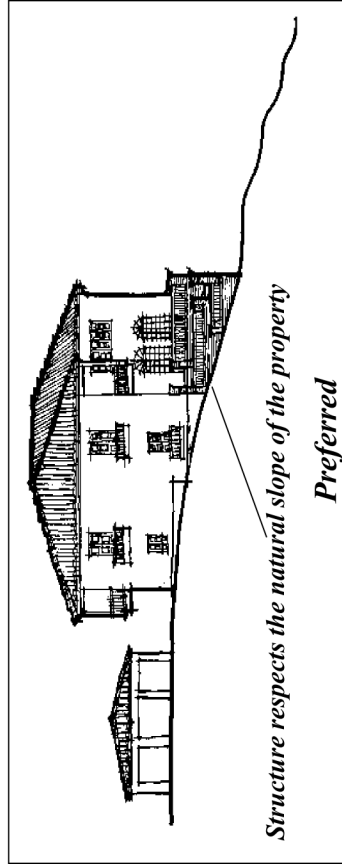

features of the site and respect the established pattern found in the neighborhood.

- The size, mass, and height of a structure should be in proportion with the size of the property and should also be in scale with nearby structures.
- Open space and landscaped areas should visually blend with adjacent properties. Buildings should be oriented so that outdoor space will visually connect between properties and extend a sense of open space, while maintaining a sense of privacy.
- Private open space such as patios, gardens, recreation courts, and play areas should be placed in a manner to maximize use of sun and shade patterns, natural drainage and existing trees and vegetation.

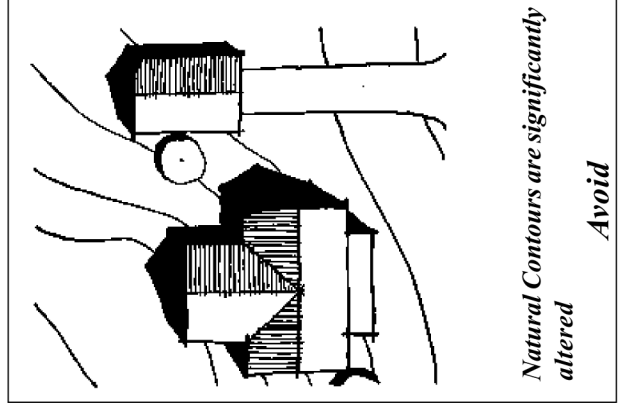
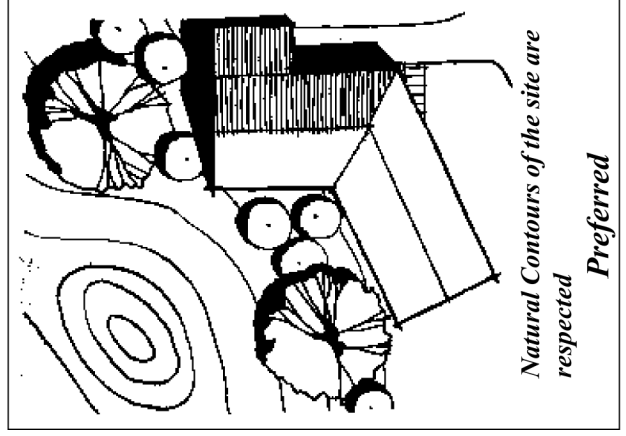

RESIDENTIAL DESIGN GUIDELINES



a. Additions, New Accessory Buildings, Patios, and Garages:

Additions, new accessory structures, patios, and garages should maintain the look and appearance of the existing primary structure so that they do not appear as an addition or new building. They should respect the architectural style, scale, and rhythm of the existing primary structure. The following are guidelines for the design and placement of additions and new accessory buildings:

- Additions and new accessory buildings should be architecturally compatible with the existing primary structure on the property and furthermore in harmony with the neighborhood.

An addition should complement and balance the overall form, mass, and composition of the existing primary structure on the property.

- Additions are strongly encouraged to be located behind the house away from public view. Additions in the front yard are strongly discouraged.
- Building elements for additions and new accessory structures, such as roof pitch and style, building proportions, exterior siding and

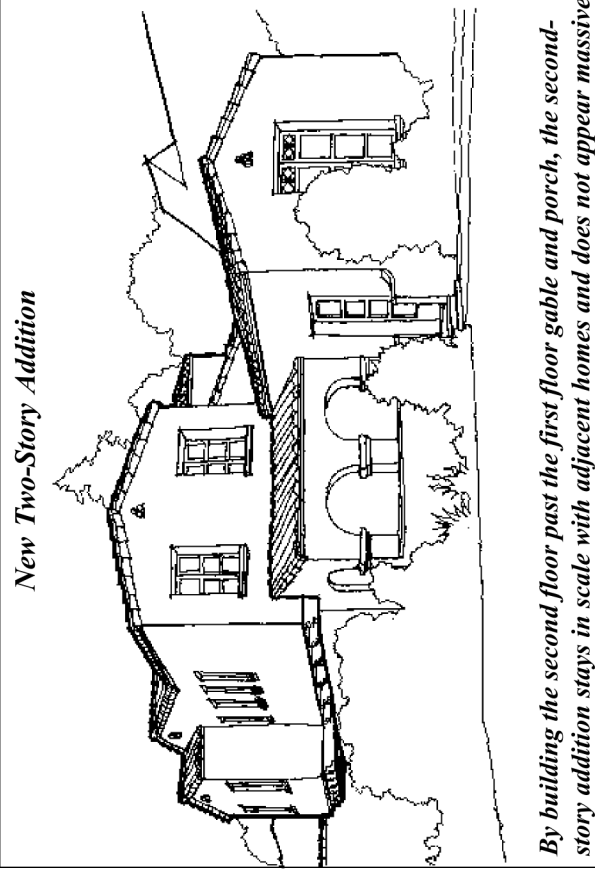
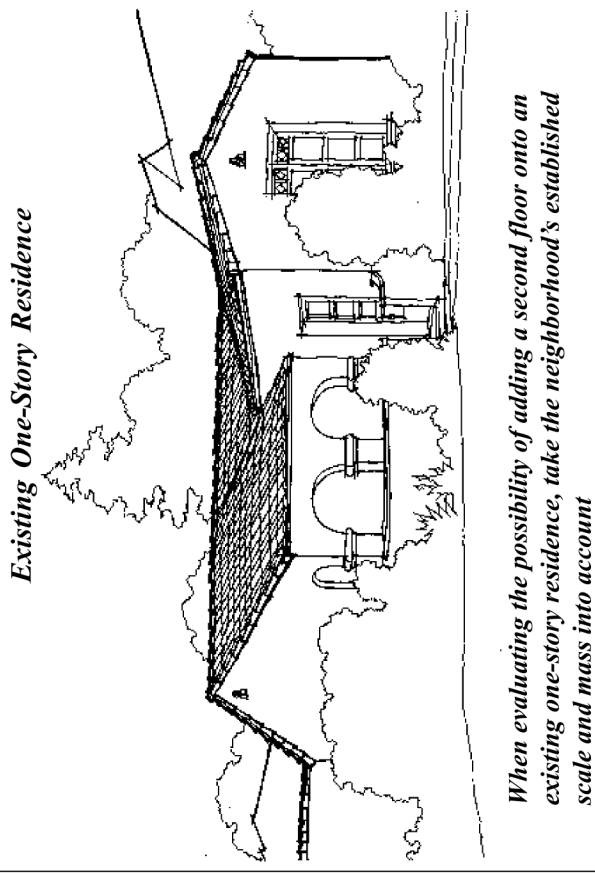

RESIDENTIAL DESIGN GUIDELINES

roofing materials, door and window style and materials, color, and texture, should match the existing primary structure on the property.

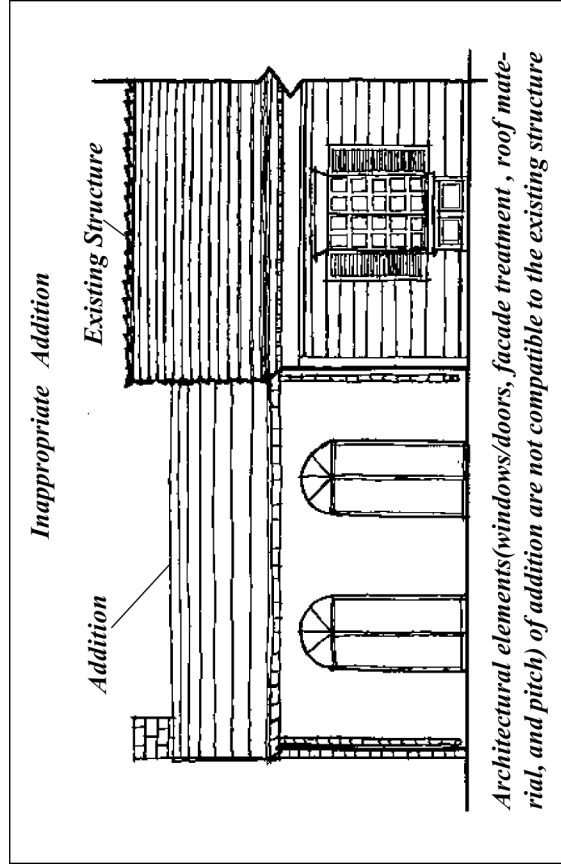
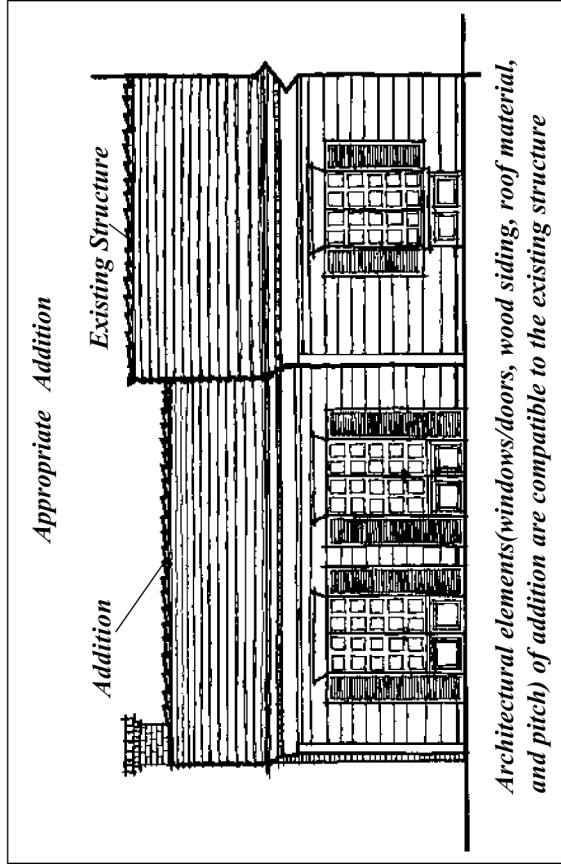

- Garages should be detached from the primary structure and their placement dictated by the established neighborhood pattern.
- The architectural style along with common architectural details seen on the house should be incorporated in the design of garage doors.

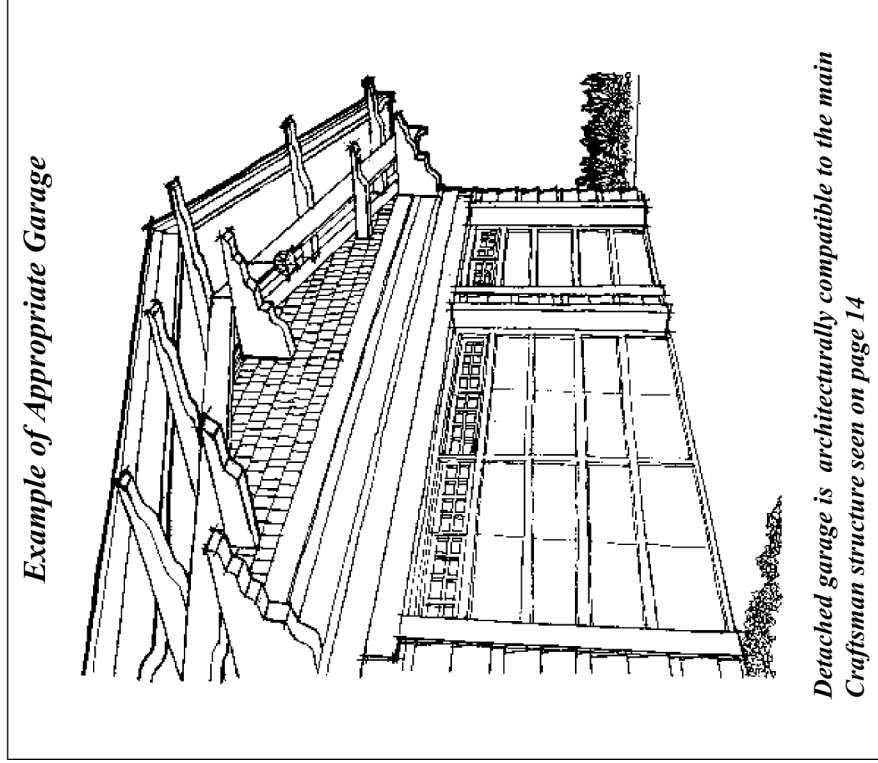

RESIDENTIAL DESIGN GUIDELINES



- Patio covers should incorporate exterior building materials and colors commonly found throughout the primary structure on the property. The use of vinyl, aluminum or other metal materials are strongly discouraged for use on patios.
- Enclosed patios should incorporate exterior building materials commonly found on the primary structure. The finished patio should complement and be compatible with the primary structure rather than appear as an afterthought.

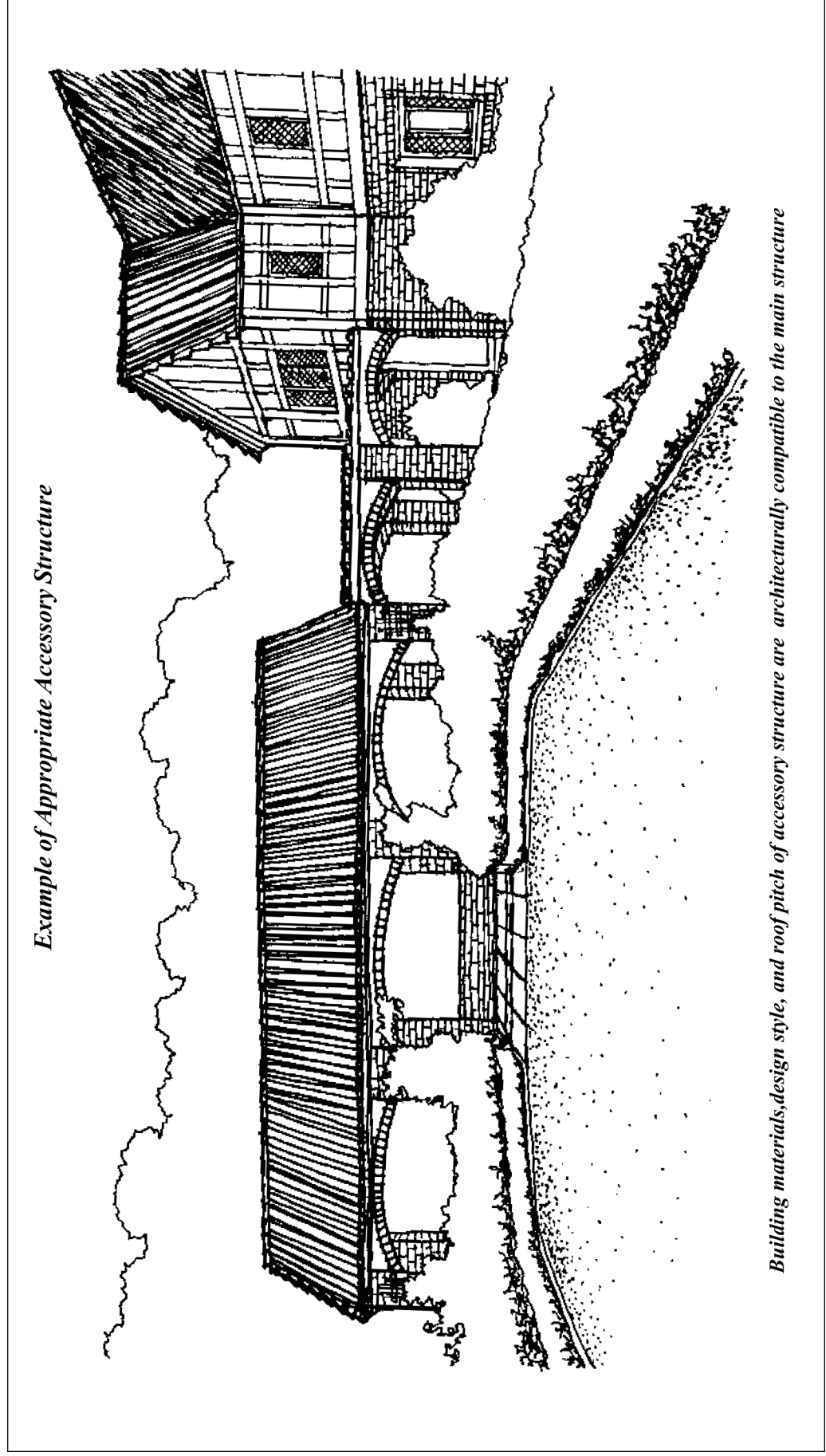

Example of Appropriate Accessory Structure

Building materials, design style, and roof pitch of accessory structure are architecturally compatible to the main structure



RESIDENTIAL DESIGN GUIDELINES

- b. New Homes:** The following guidelines are intended to ensure that the design and development of new homes respects the existing pattern, scale, and character of the existing homes in the neighborhood:
 - New homes should be compatible with the height, setback, proportion, and scale of the houses in the neighborhood. They should also be compatible with the existing on-site relationships of the surrounding neighborhood such as front facade orientation, scale of front entries, front porches, and front yard landscaping.
 - Development of new homes should respect the natural features and assets of the site including land forms and trees. Site design that requires altering land forms and removing trees is strongly discouraged.

- The front entry should be well defined in scale with the house, and not distract attention from the rest of the house.
- The architectural style and design of building elements including building proportions, exterior siding or facade treatment, roof pitch, style and materials, door and window style and materials, color, and texture should be consistent within itself and complimentary with the neighborhood.
- The design of a new home should not maximize the allowable lot coverage. It should provide ample open space around a structure and incorporate a variable footprint within the required set backs. This will result in a more interesting structure, allow for sunlight and air, provide privacy, and preserve the character of the neighborhood.

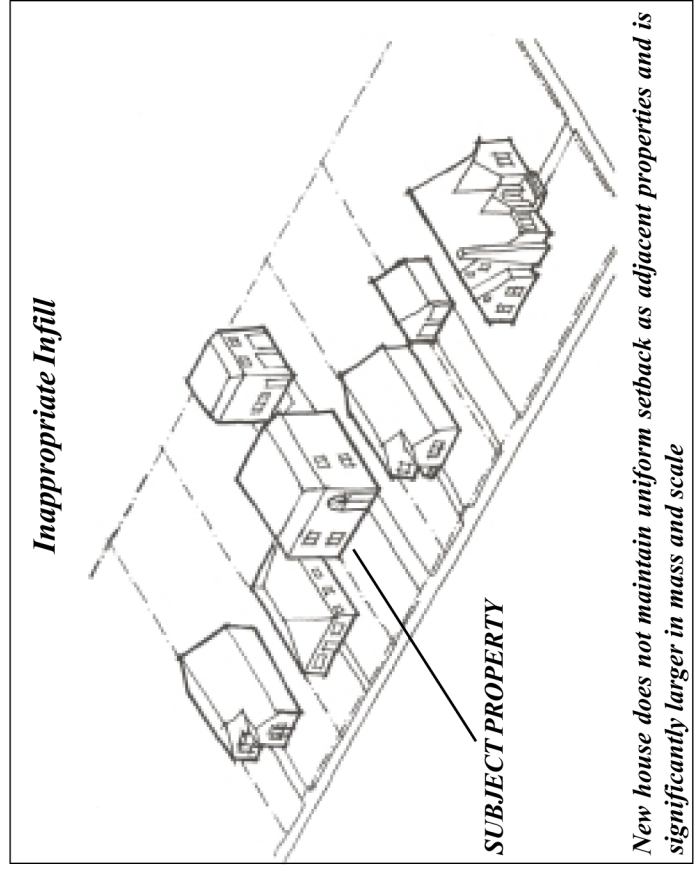
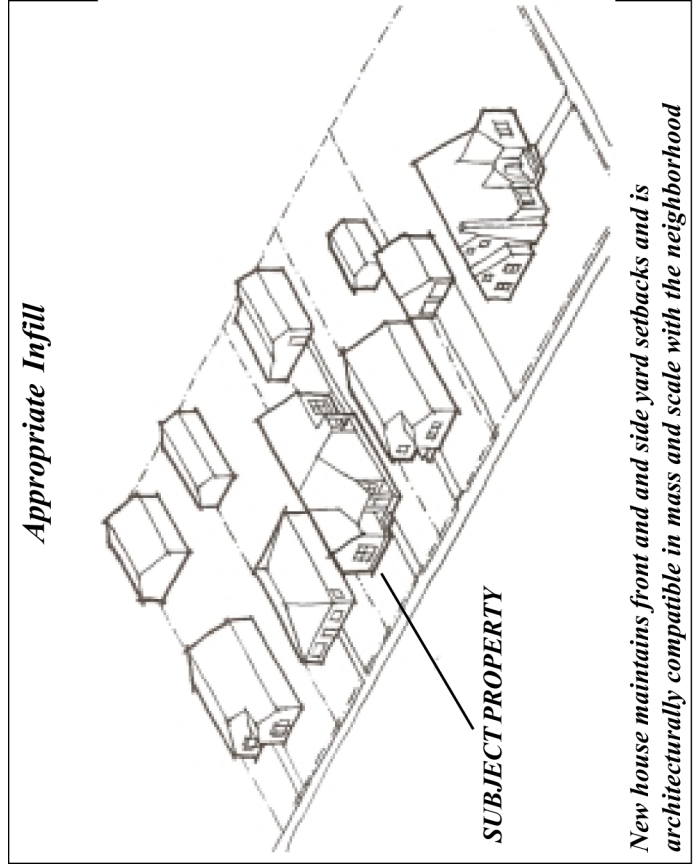

RESIDENTIAL DESIGN GUIDELINES



- sign windows for through airflow to promote natural cooling.
- Orient the building or addition on the site to respect natural landforms. Use patios and porches to buffer the building from heat gain.
- Incorporate attic turbines for ventilation and energy-efficient heating and air conditioning systems.

2. Environmental Considerations: The intent of this section is to offer tips on how to conserve energy, materials, and money by using time-honored strategies of good design.

a. Shade and Sun, Cooling and Heating:

- Use roofs with large overhangs and trellises or deciduous trees over south-facing windows.
- Use windows for natural light as much as possible. De-

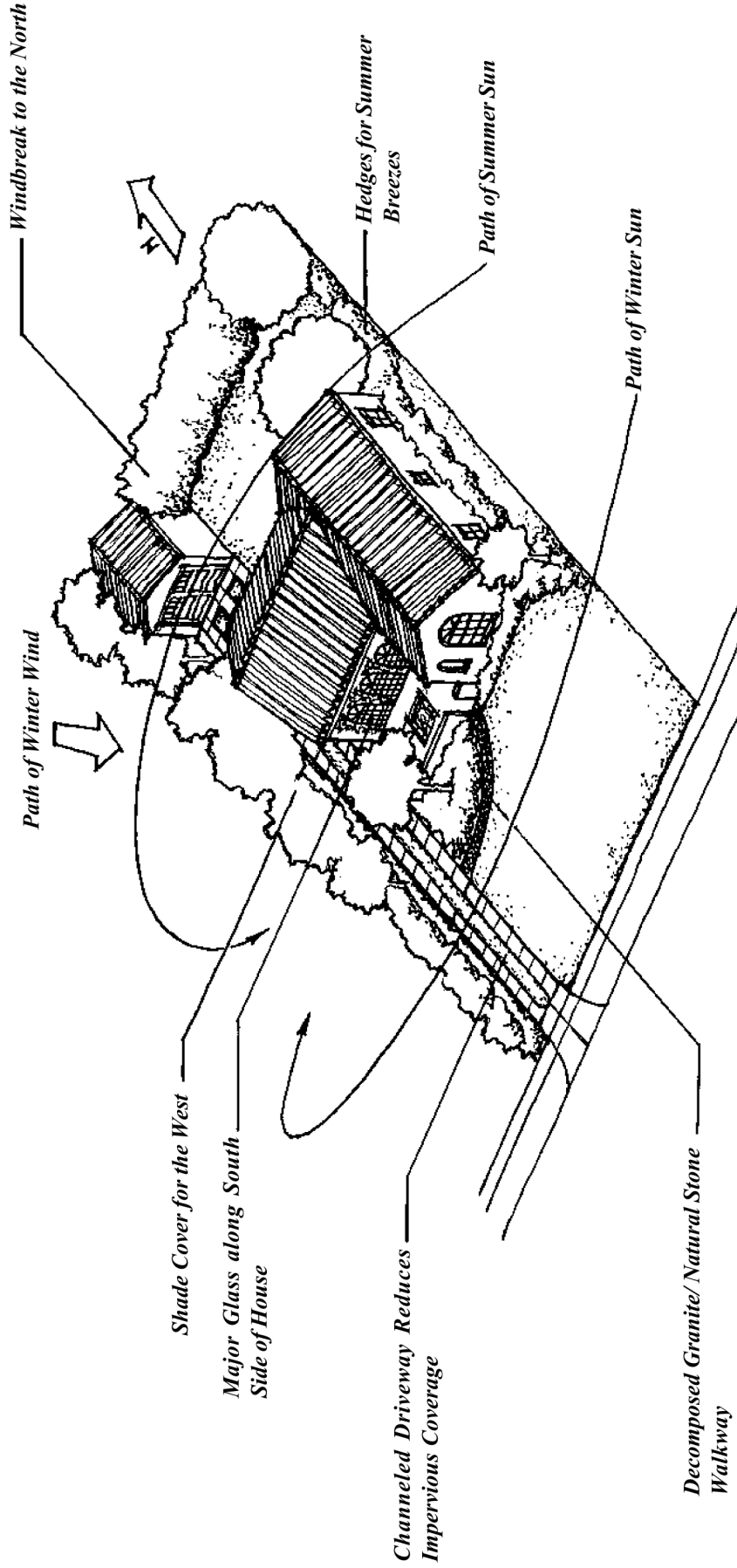



RESIDENTIAL DESIGN GUIDELINES

b. Impervious Coverage and Landscape Areas:

- Maximize vegetative ground cover on the lot. Ground should absorb rainwater, provide drainage to large trees on the site, reduce runoff.
- Use permeable surfaces whenever possible, reduce paving. Use decomposed granite or medium textured shades of concrete or brick for hard surfaces.
- Use trees and shrubs to shade the house and provide a pleasant parklike atmosphere. Use native planting or compatible species of drought-tolerant plants as much as possible to reduce water demand.
- Extensive paving in the rear yard intensifies surface runoff and prevents rainwater percolation and is highly discouraged.

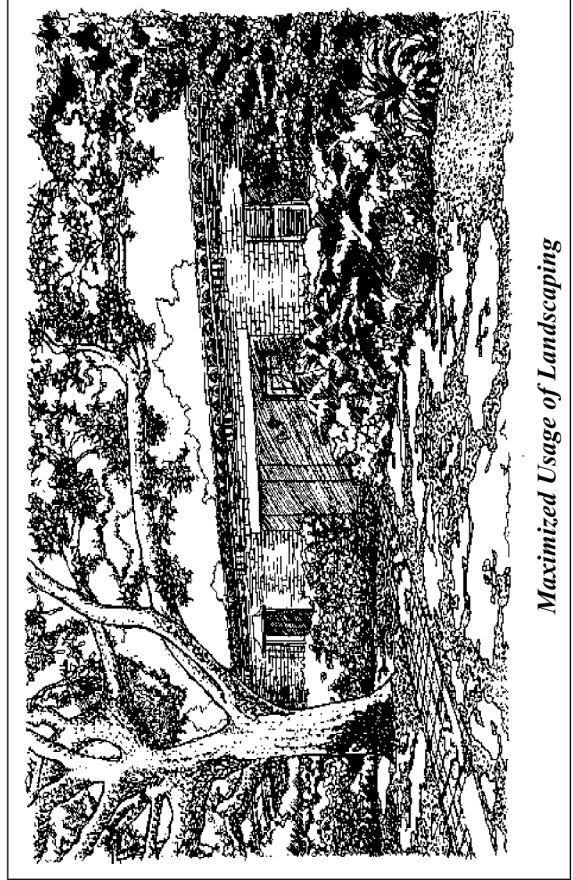

Maximized Usage of Landscaping

c. Sustainable Building Materials:

- Recycle, repair and maintain well-built existing structures to the fullest extent possible.
- Use quality materials with a long life-span to reduce cost over the life of the structure.
- Select materials for new and remodeled projects that are not energy-intensive to manufacture.
- Use building products made from recycled materials.

d. Economies of Scale:

- Maximize floor area usage. Combine uses of space and eliminate unnecessary rooms. Organize rooms to eliminate hallways.
- Simplify floor plans. Reduce the number of bedrooms in order to avoid large garages.
- Incorporate adequate storage areas by utilizing all areas of the enclosed building volume.
- Use garages for vehicle storage and eliminate unused household storage.

RESIDENTIAL DESIGN GUIDELINES

C. PHYSICAL DESIGN COMPONENTS

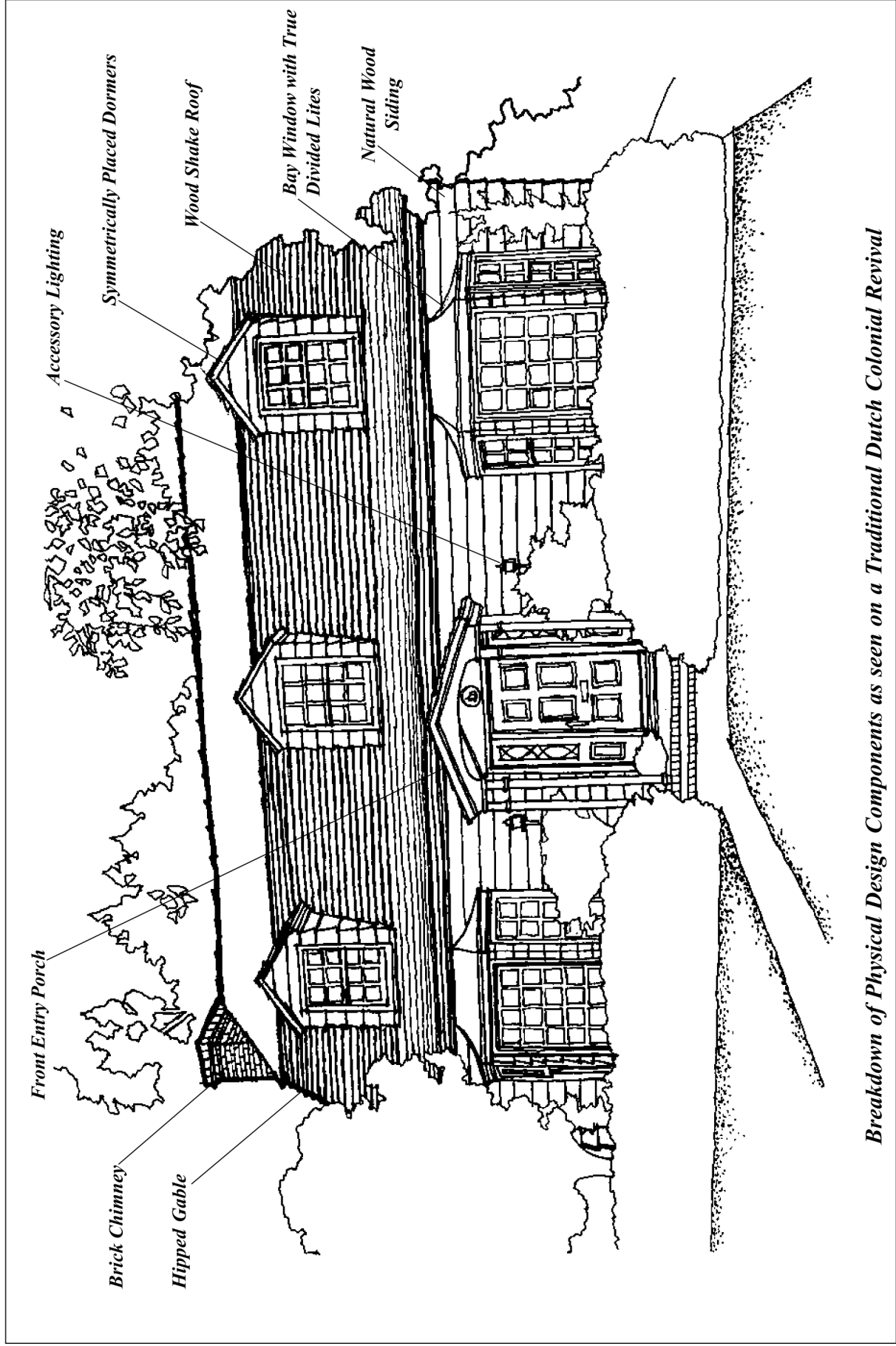

Breakdown of Physical Design Components as seen on a Traditional Dutch Colonial Revival

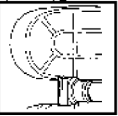

RESIDENTIAL DESIGN GUIDELINES

1. Mass and Scale: The mass of a structure is attributed to its floor area, height, relationship to the site, and the design of its architectural details. Structures that are out of scale with the neighborhood, with large, blank, flat surfaces, and insufficient open space and mature landscaping can appear out of place and incompatible with their surroundings. The following are guidelines to help reduce excessive mass and scale:

- New residences and additions should be compatible in mass and scale to surrounding buildings in the neighborhood and with the natural site features. A finished project should convey a sense of human scale.
- Buildings should maintain a proportional relationship to buildings on adjoining properties. Through the use of similar proportions and details, buildings should follow the established scale of the existing streetscape.

Architectural elements, such as simple roof forms, facade articulation, roof breaks, walls with texture materials and ornamental

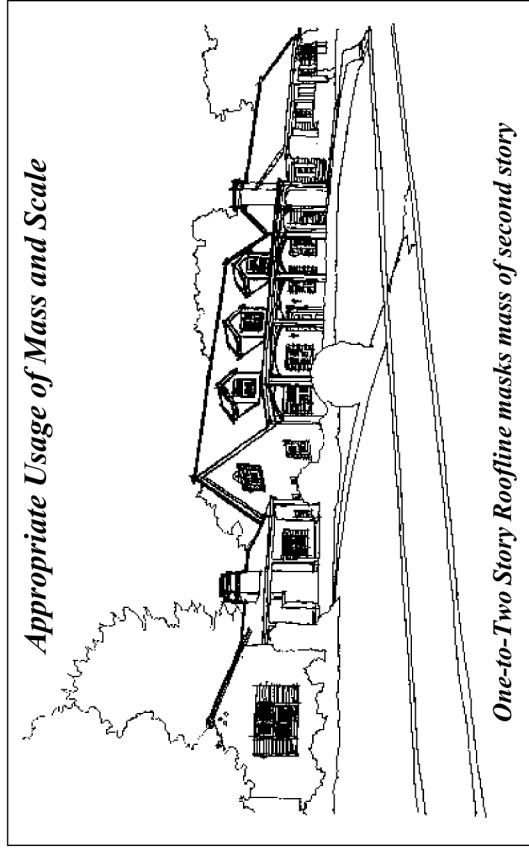

details, and incorporation of landscaping, add visual interest and reduces scale.

- a. Building Volume:** There are several architectural approaches used to minimize the appearance of building volume.
 - To reduce building volume, understated entries and low pitched roofs are strongly encouraged to help give a sense of human scale to homes.
 - Second floor balconies and small decks accented with landscaping can reduce the visual impact of two-story structures.
 - To reduce appearance of “boxiness”, use of single story roofs and porches on front elevations is encouraged.
 - Expansive, two-story, floor to ceiling entries are strongly discouraged.
 - First and second floor plate heights should be consistent with those established on other homes in the neighborhood.

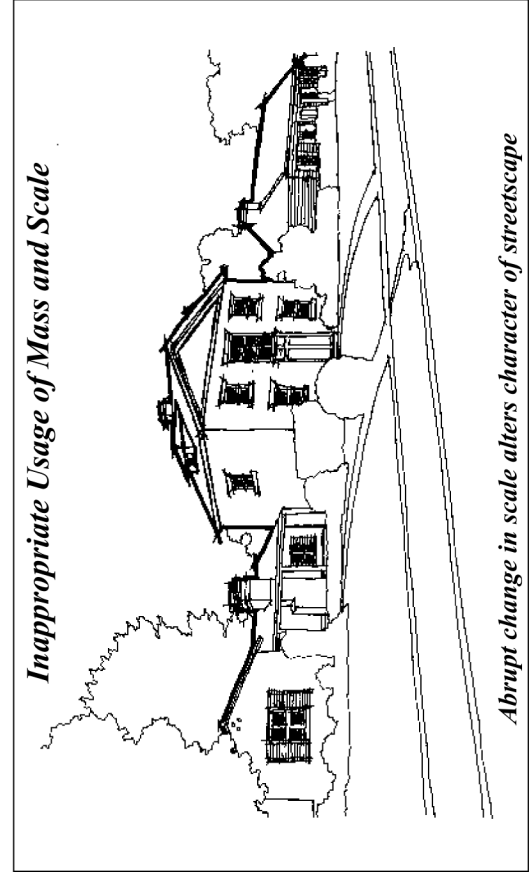

RESIDENTIAL DESIGN GUIDELINES

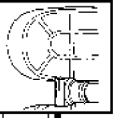

- b. Height and Roof Lines:** Height and roof lines influence the overall mass and scale of a structure. When planning for a residential addition, it is important to evaluate the slopes and ridgelines of the existing structure. The terrain of the site should also be considered when determining the structure's height. A well designed roof plan is architecturally consistent, compatible with neighboring structures, and follows the natural contours of the site. The following are guidelines for appropriate design and development of building height and roof lines:
- Height and rooflines should follow the neighborhood's character. An addition should maintain the same plate height of the original structure.
 - The visual impact of roofs should be minimized. Creative roof plans use ridgelines to screen all vents, flues and skylights from public view.

- When planning for a residential addition, it is important to evaluate the existing slopes and ridgelines of the structure. Matching the original slopes and ridgelines are strongly encouraged.
- For new houses, it is important to consider the style of architecture when designing the roof plan.
- Avoid the use of expansive, predominately flat roofs. Break roofs into smaller, geometric elements. For remodels and additions, roofs should be broken up with hip and gable framing and pitched dormers.
- Avoid too many different roof angles or roof types on a structure as they create a disjointed, chaotic appearance.

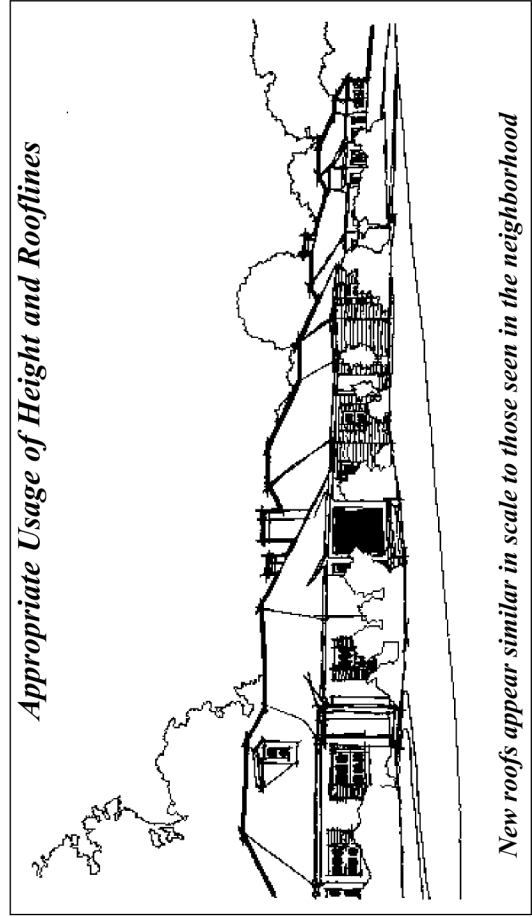

Appropriate Usage of Height and Rooflines

New roofs appear similar in scale to those seen in the neighborhood

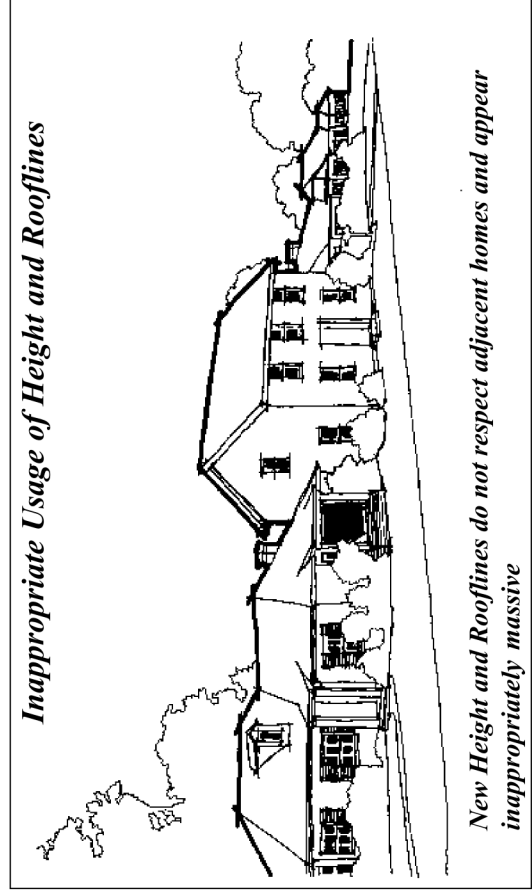

Inappropriate Usage of Height and Rooflines

New Height and Rooflines do not respect adjacent homes and appear inappropriately massive

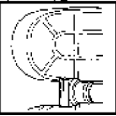

RESIDENTIAL DESIGN GUIDELINES

- c. **Facade Treatment:** Elements of a buildings' facade provide visual and contribute to the overall architectural quality of the building as well as the neighborhood. All building facades should complement each other. The following are guidelines for appropriate facade treatment:
 - Facade treatment, relevant to the home's architectural style, should be carried throughout the entire house with each facade and any accessory structure.
 - Architectural features such as decorative moldings, windows,

- dormers, chimneys, balconies and railings, and landscaped elements such as lattices, can add detail to a facade and are encouraged.
- Facades should be articulated to show fenestration and recessed planes. Large areas of flat, blank wall and lack of treatment are strongly discouraged.
- Facades should help to provide a sense of human scale.

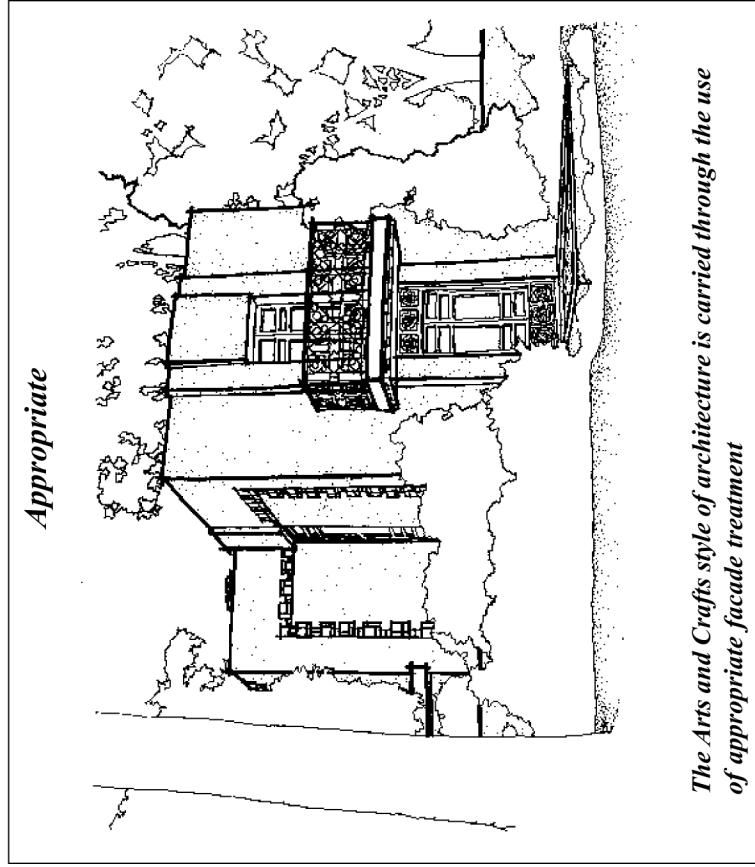

The Arts and Crafts style of architecture is carried through the use of appropriate facade treatment

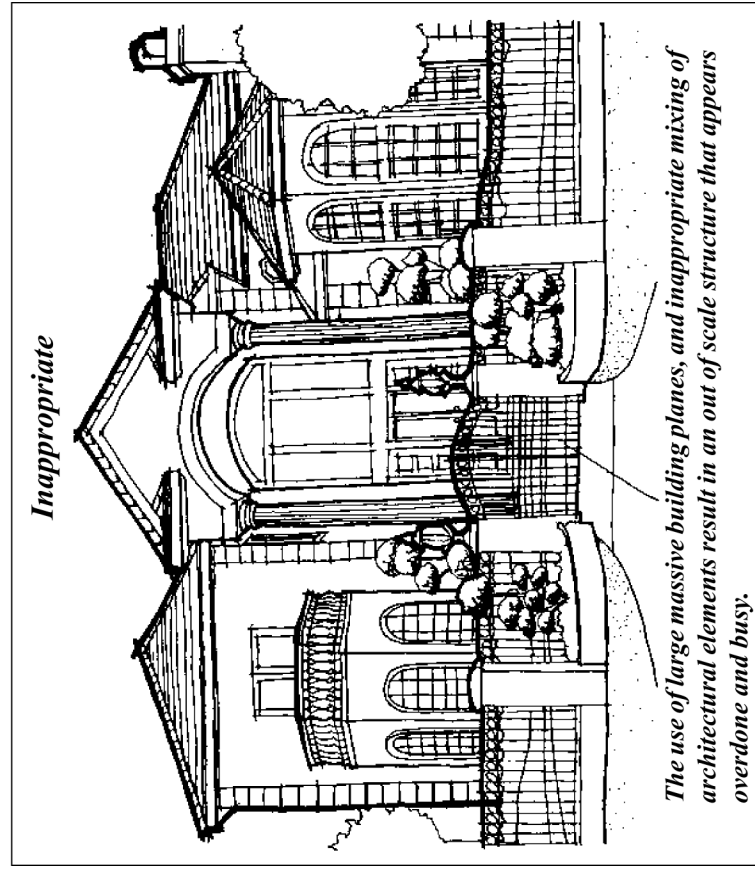

The use of large massive building planes, and inappropriate mixing of architectural elements result in an out of scale structure that appears overdone and busy.

RESIDENTIAL DESIGN GUIDELINES

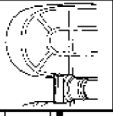

- d. **Front Entries:** A front entry consists of the front door and its surrounding architectural elements. Front entries serve as the primary focal point of a residence. The following are guidelines for appropriate front entry treatment:
 - Smaller entries help create a more human scale to a home and are strongly encouraged.
 - Recessed entries can create an elegant, intimate feel while adding human scale to a home and are encouraged.
 - Front entry doors and decorative elements such as moldings, columns, posts, lighting, and built-in benches and planters should be architecturally consistent with the style of the house.
 - One-story roofs or overhangs that serve as porches, appropriate to the architectural style, are strongly encouraged.

- Large, massive entries that appear two-story are strongly discouraged.

Inappropriate Front Entry Treatment

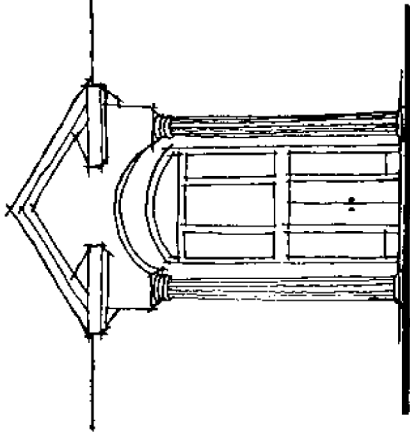

Two-story entries appear inappropriately massive and are discouraged

Appropriate Front Entry Treatment

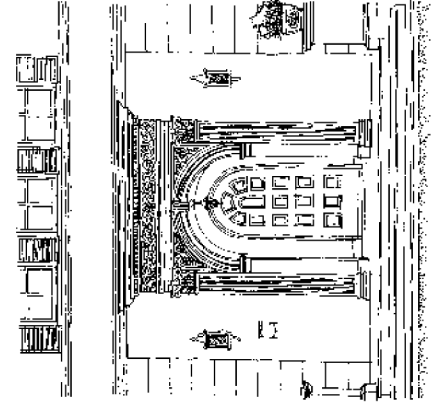

Recessed entries and front porches create an elegant feel while reducing the appearance of mass on these two-story homes

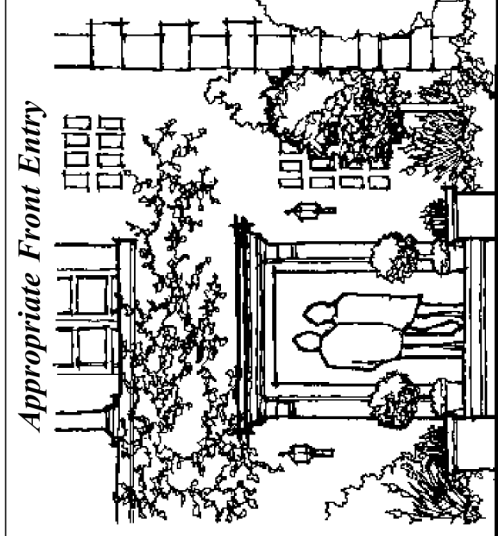

First-floor, recessed entry reduces the appearance of mass by adding human scale to the home

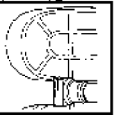

RESIDENTIAL DESIGN GUIDELINES

e. **Integrity of Architectural Details:** Architectural details are decorative and ornamental elements that can add visual interest, convey a human scale, and contribute to the design and style of architecture. Such details include porch columns, decorative door and window designs, exterior moldings, porch and balcony railings, roof overhangs, brackets, awnings, gutters and down spouts, fascia boards, steps and stairs, stucco and masonry, wood and shingle/shake siding, gables and lighting fixtures. The following are guidelines for appropriate design and use of architectural details:

- The use of architectural details is strongly encouraged. Their use should integrate the elements of detailing to produce a pleasing view consistent with time honored architectural style.
- The design of architectural details should be consistent with the architectural style of the project.
- Random or nonintegrated mixing of decorative/ornamental details that produce a chaotic visual presentation detracting from the overall architectural style of the structure should be avoided.

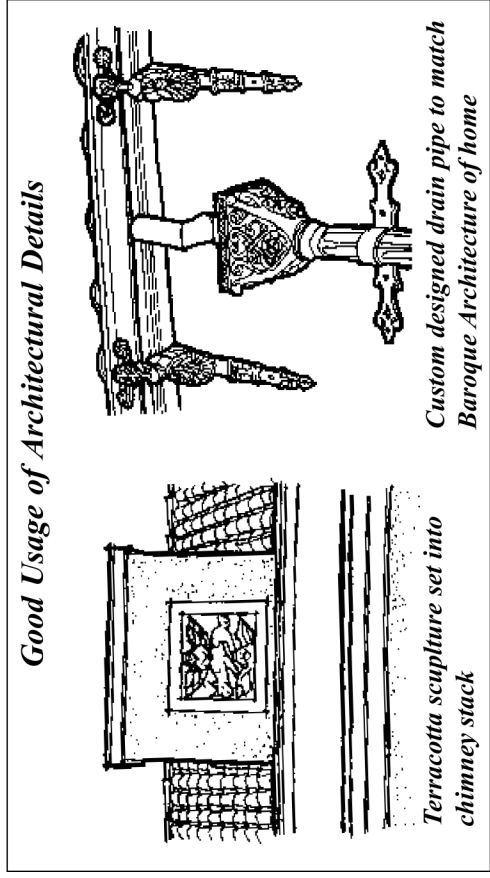
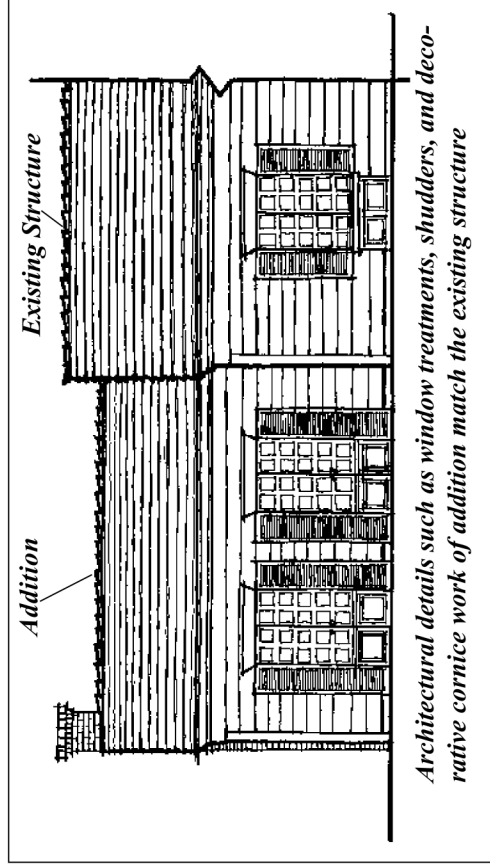
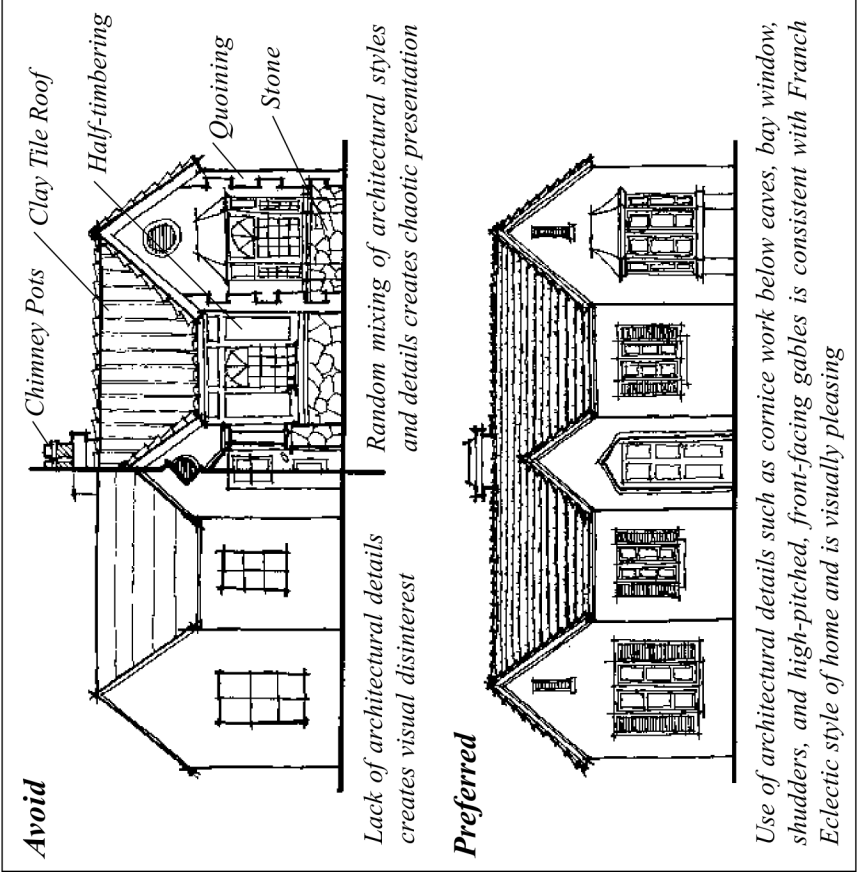

RESIDENTIAL DESIGN GUIDELINES

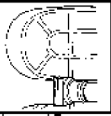

- 2. **Windows and Doors:** Windows and doors are important to the exterior design of a structure, particularly for residential additions. The objective for residential additions is to design the addition in a manner, which will be harmonious with the original house. The following are guidelines for appropriate design, placement, and materials of windows and doors:

ENCOURAGED

- For additions, all new windows and doors should match those that are on the existing structure. For new structures, all windows and doors should be related with the chosen architectural style.
- All window frames and doors should be composed of the same material as those found on the existing structure.
- Proposed window mullion widths, window trim or surrounds, material, and type should complement all existing windows. Mullion widths should be in scale with the windows and the structure.

- Windows made of natural material such as wood are encouraged.
- Windows lites should be true divided and proportional. If the original windows of the structure have true divided lites, then the new windows should have true divided lites.
- For additions and remodels, whenever possible, single glazing, consistent with energy code requirements, is encouraged. Given the choice between double and single glazed (pane) windows, match the existing windows of the house

Window Treatment

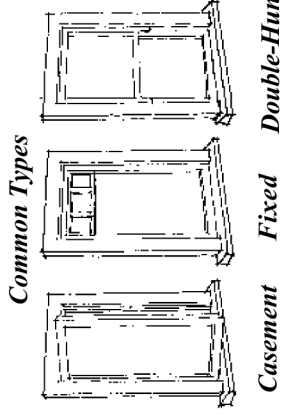

Common Types

Casement Fixed Double-Hung

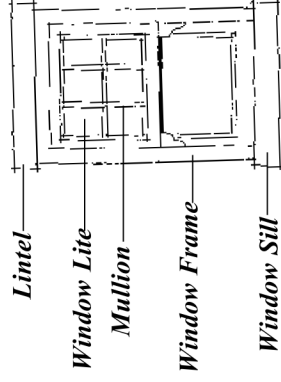

Lintel
Window Lite
Mullion
Window Frame
Window Sill

True divided lite windows with raised exterior mullions are preferred

Appropriate Window Treatment

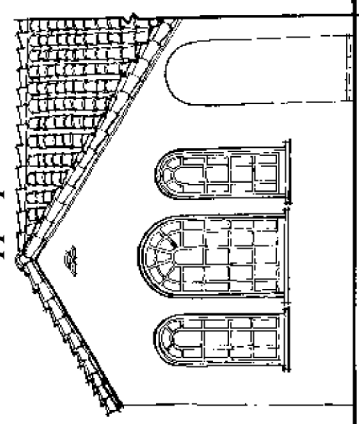

True divided arched windows complement the existing arched entry to the Spanish Colonial home

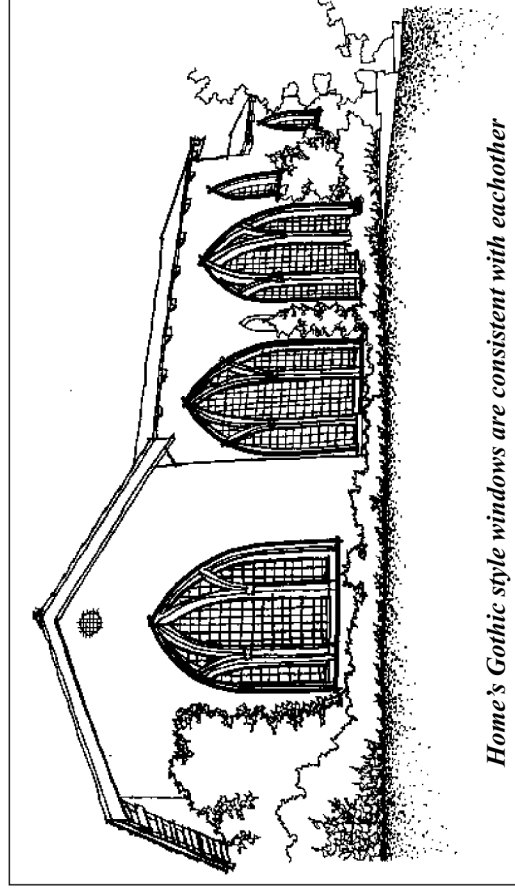

Home's Gothic style windows are consistent with each other

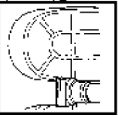

RESIDENTIAL DESIGN GUIDELINES

DISCOURAGED

- Windows frames made of a variety of materials are strongly discouraged.
- Windows with widely varying styles are strongly discouraged.
- Windows made of flat, mill finished aluminum are strongly discouraged.
- Wide mullion widths are strongly discouraged.
- Designs intended to simulate true divided lites, including “snap in grids”, are strongly discouraged.
- Vinyl-clad, wood windows are discouraged.

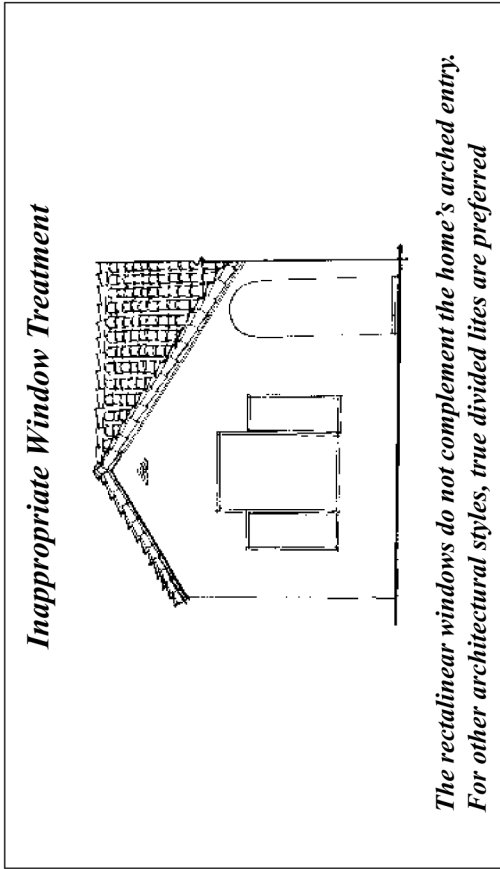

- Doors are encouraged to be compatible with the architectural style of the structure.
- Doors should be designed at human scale. Doors not in scale with the house are strongly discouraged.
- Doors made of natural material such as wood are encouraged.
- Single door entries are encouraged.

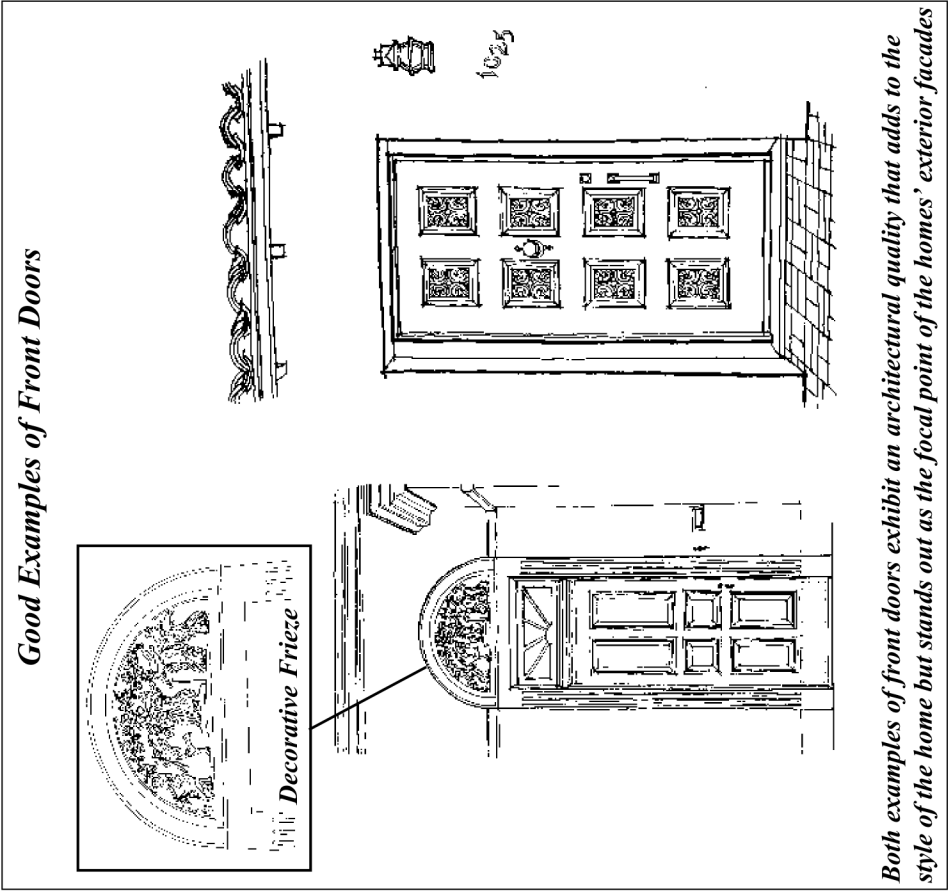

RESIDENTIAL DESIGN GUIDELINES

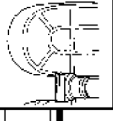

- a. Window Awnings:** Generally, window awnings are not appropriate with the architectural styles found in San Marino. However, when compatible with a given architecture the following should be considered:
- Awning shape should match the window shape.
 - Covering several windows with a single awning is strongly encouraged. One awning should cover one window. One awning for several windows would not be proportional to the structure.
 - Use the same type and color awnings for the entire structure. When adding new awnings, it is encouraged to replace deteriorating awnings at the same time.
 - Fabric awnings are preferred. Plastic, metal, or wood awnings are discouraged. Metal awnings are easily dented and scratched, and do not have the quality of cloth.
 - Window awning color should accent the colors on the structure.

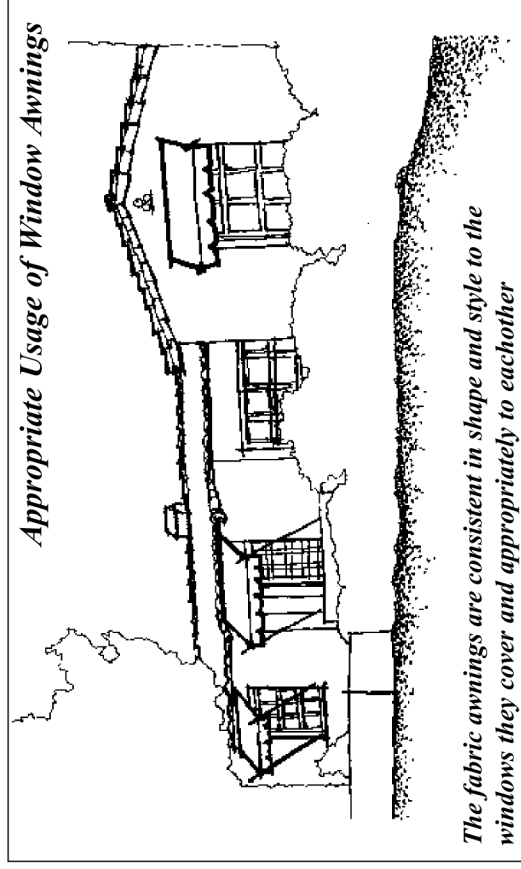

- 3. Integrity of Building Materials, Color and Texture:** The exterior presentation of a structure, its use of materials, textures and colors, contributes toward whether it will be compatible with the neighborhood. The following are guidelines for the appropriate use of building materials, color, and texture:
- In remodels and additions, new materials should match those of the existing structure. Accessory structures should match materials, finishes, and colors, found on the primary structure.
 - For new structures, the repetition of textures and color found in the neighborhood can help tie the new structure to its surroundings.
 - The use of at least one strong accent material is encouraged. Too many exterior materials are discouraged. The use of too many different materials can make a design appear too “busy”.
 - Natural materials are preferred. Synthetic materials for the building made to simulate natural wood and masonry are discouraged.
 - Architectural design and exterior materials should be applied consistently on all sides of the structure. When using wood siding or masonry as a primary or accent material in the front, extend it down the sides, at least to an inside corner. Do not stop at an outside corner.
 - Stucco and plaster finishes should be consistent with the architectural style of the structure. The use of very rough, “knock-down” stucco finishes is strongly discouraged, as they are not considered compatible with most of the architectural styles found in the city.

RESIDENTIAL DESIGN GUIDELINES

- For most architectural styles, the number of colors on the exterior should be limited to a maximum of three, with an additional contrasting color for accent. In general, the lighter colors should be used for the main body, with darker shades for trim and accent. The larger and simpler the house design, the more subtle the color should be to reduce the massiveness of large wall planes.

Appropriate Usage of Color

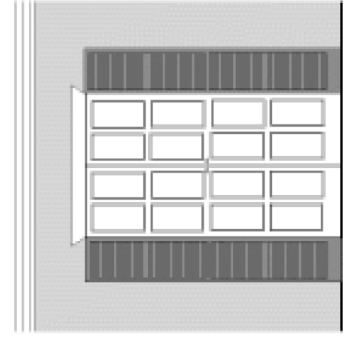

Use darker earth tones with lighter trim or lighter shades with dark trim to create contrast

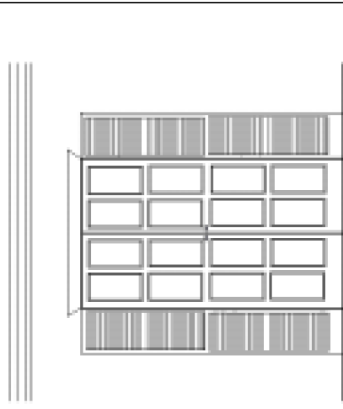

Avoid bright "white-on-white" colors as they do not create contrast

Appropriate Usage of Building Materials

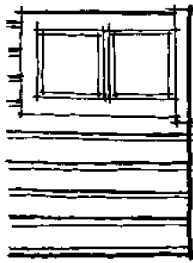

Board and Batten

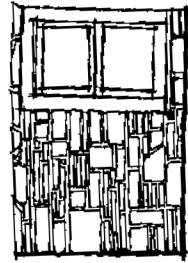

Cut Stone

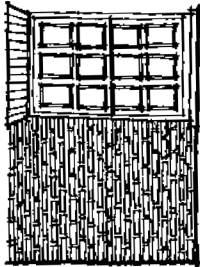

Brick

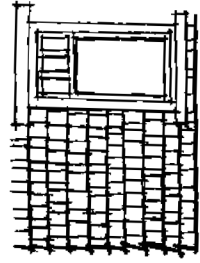

Shingle

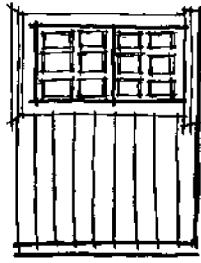

Wood Siding

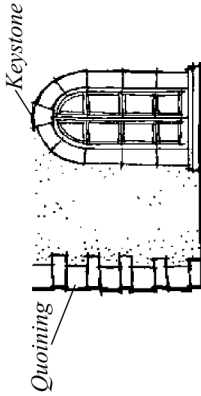

Quoining

Keystone

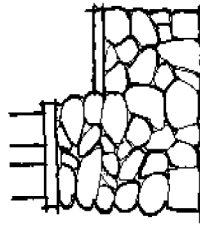

Stone

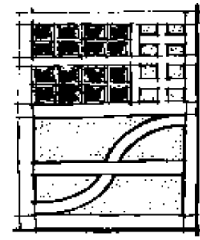

Stucco

Half-Timbering

- Earth tones are best suited and are appropriate for most of the architectural designs found in the city. The use of strong or bright, unnatural colors, including the bright "white-on-white" color schemes for exterior stucco, wood siding, trim doors and shutters, should be avoided. However, the use of strongly contrasting, natural colors can be appropriate for accent use, such as for shutters and doors.

- Roof Treatment:** The roof is one of the most important elements contributing to the sense of scale and proportion of the building. Depending on roof pitch, it could be the most visible architectural feature found on a structure. The design should be harmonious to itself, the overall building structure, and the structure's architectural design. Historically, nearly all the city's homes originally were roofed with natural materials, predominantly wood shingles and shakes, mission style clay tiles, and to a lesser extent, natural slate. These materials were selected primarily for their architectural integrity with the house design, their harmony with the natural setting, their high quality and durability, and have contributed significantly to maintaining the overall quality and understated elegance of the city. It is the city's desire to maintain this overall feeling.

RESIDENTIAL DESIGN GUIDELINES

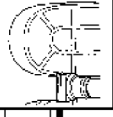

The City's Planning and Building Department maintains a list of pre-approved roof materials and the conditions under which they may be used with an "over-the-counter" approval by staff. These roof materials have been found in most applications to be quite compatible with the variety of architectural styles found in San Marino and are strongly encouraged. Materials not on this list must be submitted to the Design Review Committee for approval before use. Because this pre-approved list changes periodically, applicants are encouraged to obtain the most current list from the Planning and Building Department.

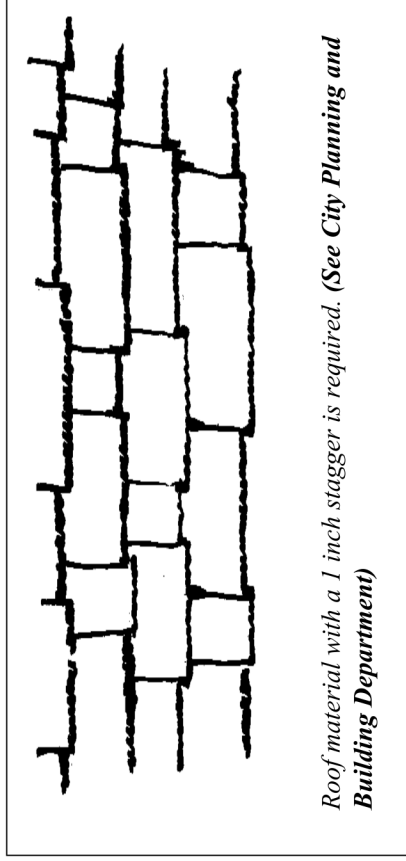

The following are guidelines for appropriate roof treatment:

- Roofing materials should be compatible with the architectural style and design of the structure.
- Selection of a synthetic roofing material should take into account the architectural style and design of the house, the amount of roof area exposed to public view, the shape of the roof, the roof slope, and sun angles. Synthetic roofing material should be architecturally compatible with the structure and with the neighborhood.
- Natural barrel clay tile roofs should be replaced with the same

material. For repairs, remodels, and additions, care should be taken in the selection of material and installation to match as closely as possible the color of the "aged" tiles, so that the finished roof does not have a patched look. Certain "S" tiles for new and replacement roofs are acceptable subject to specific City approved applications.

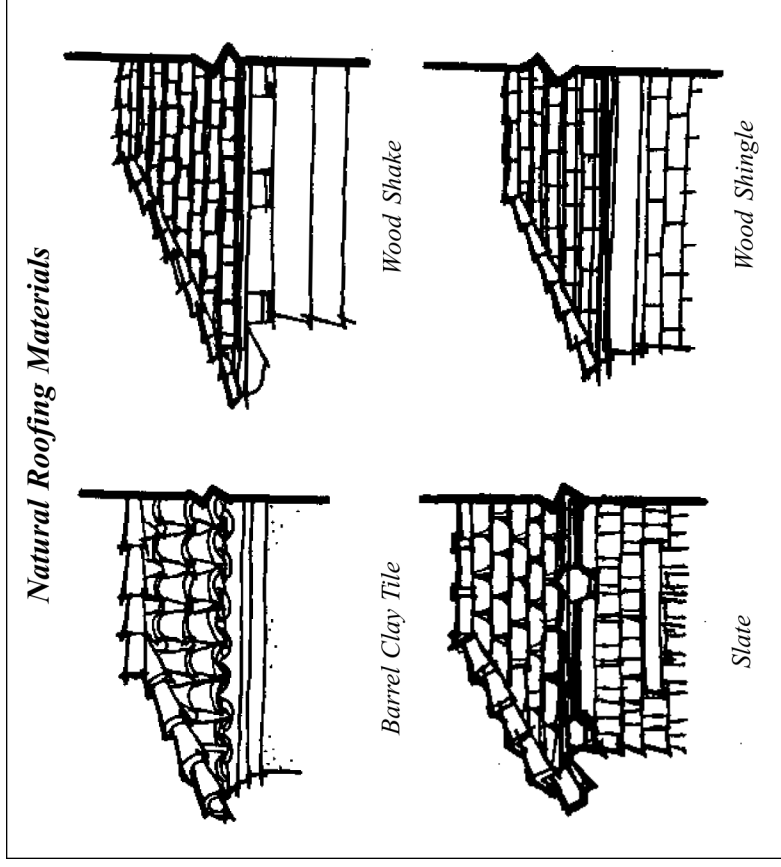

- The colors of natural roofing materials, such as wood, barrel tiles and slate should be left natural and not be altered by staining or painting. Colors of synthetic roofing materials should simulate natural materials and should be consistent with the architectural style of the house.

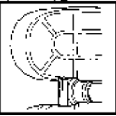

RESIDENTIAL DESIGN GUIDELINES

- The blending of more than two colors on a roof is discouraged. However, two colors may be acceptable provided that one of the colors is clearly used more frequently than the other.
- Roofing materials with glossy surfaces appear unnatural and are strongly discouraged.
- a. Chimneys:** Chimneys provide aesthetic and practical functions. They also provide a vertical counterpart to an otherwise horizontal structure. The following are guidelines for chimneys:

- Chimneys should be designed to reflect the architectural style of the structure and be appropriate in scale with the structure.
- Chimneys should use materials and detailing compatible to those found on the structure.
- For remodels and additions, new chimneys should match the scale, design, and materials of any existing chimneys.
- Spark arresters should be architecturally compatible with the structure.

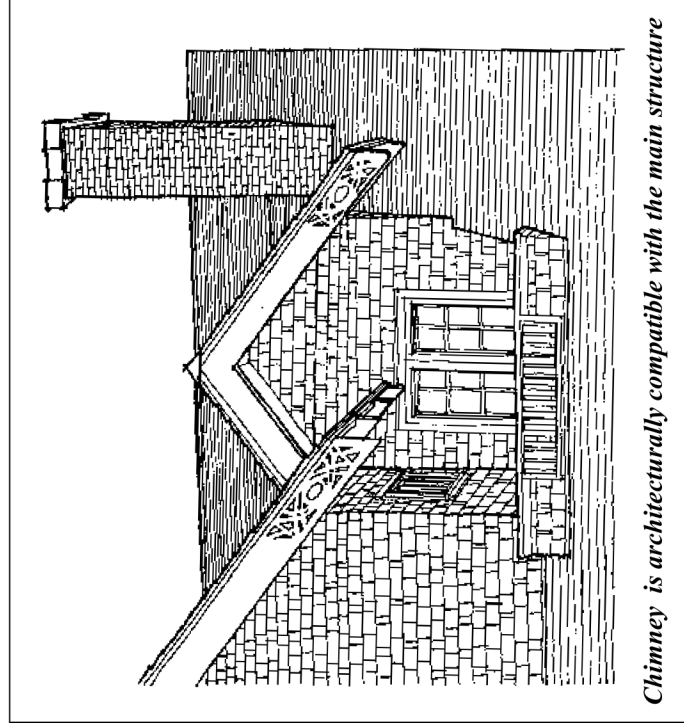

Chimney is architecturally compatible with the main structure

- b. Skylights:** Skylights are roof windows used to allow natural light into the interior of the structure. The following are guidelines for the use of skylights:
 - Skylights should be designed as an integral part of the roof. Their design should not disrupt the architectural character of the structure or the spacing of windows, dormers or chimneys. Skylights should be placed on the least visually prominent section of the roof and away from public view.
 - Skylight frames should be non-reflective and should match the existing roof material color. Skylight glazing should be clear or solar bronze. White glazing is inappropriate.
 - Flat profile glass skylights are preferred. Round or domed acrylic skylights are discouraged.

RESIDENTIAL DESIGN GUIDELINES

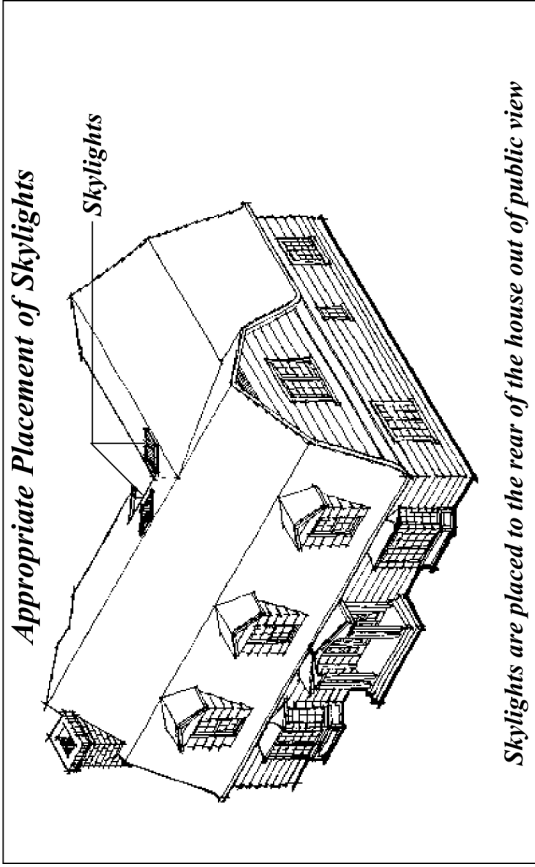
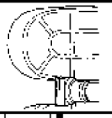

Skylights are placed to the rear of the house out of public view

c. Dormers: Dormers provide light and ventilation to the top floor of a building and can provide a means to increase liveable area. They are highly visible elements of a roof. The following guidelines should be considered when designing dormers:

- The dormer style should be consistent with the overall architectural style of the structure. New dormers should be designed to match those already existing on the structure.
- Dormers should align with or be centered between the windows found on the main body of the structure.
- Dormer trim work should be painted to match the main body trim. Dormer sidewalls should be made with the same wall materials, finish, and color found on the main building.

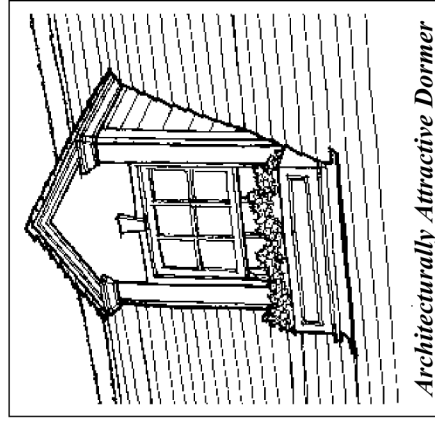

5. Accessory Lighting: Accessory lighting refers to the various forms of exterior lighting that are visible from public view. Exterior lighting can provide safety and security and accentuate architectural and landscape elements of a property. Exterior lighting can be an architectural element in and of itself. Forms of accessory lighting include all lighting fixtures on front facades, security lighting, and landscape lighting. The latter will be covered later in these guidelines under *Landscape Lighting*. The following are guidelines for appropriate placement and design of accessory lighting;

- Light fixtures should be compatible with the architectural style, materials, color, and scale of the project.
- Exterior lighting of a building facade should not wash out architectural features. Exterior lighting that reinforces the architecture and blends into the landscape is strongly encouraged.
- Accessory lighting should be positioned so that no direct light extends into neighboring properties. Illumination should be screened from adjacent properties. Cut off luminaries are widely available.

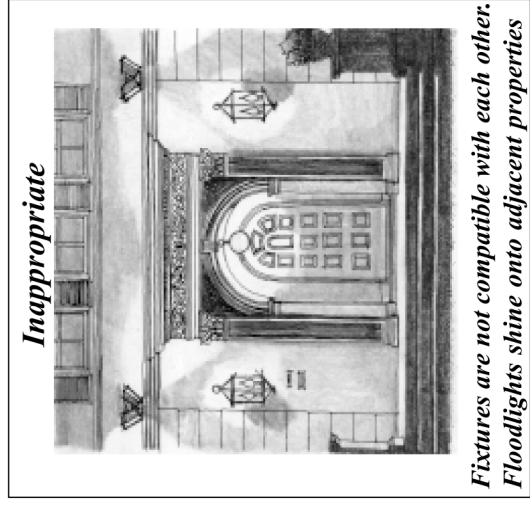
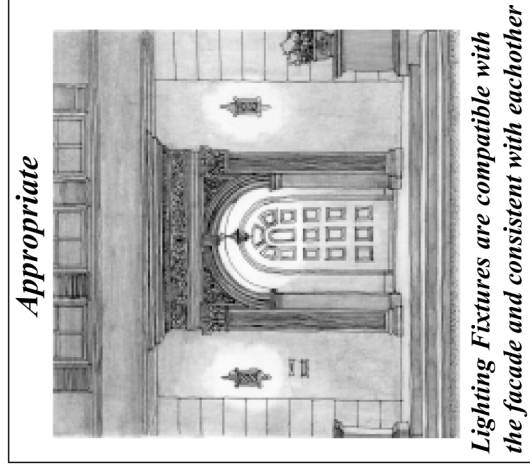



RESIDENTIAL DESIGN GUIDELINES

D. LANDSCAPING

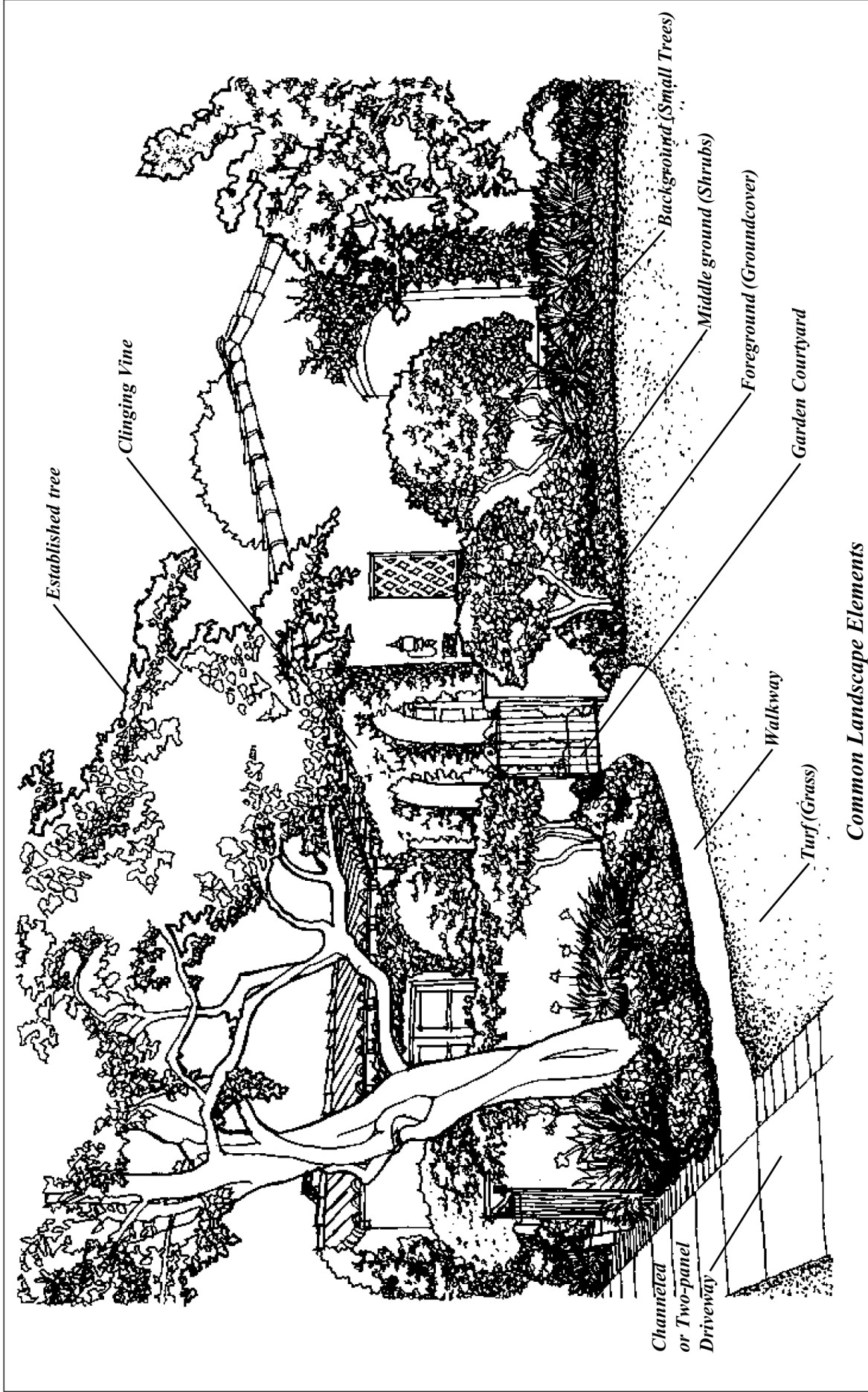

Common Landscape Elements

- 1. **Basic Landscape Principles:** The defining characteristics of San Marino landscapes are mature trees and landscaped garden areas. The following are basic principles of good landscape design:

- Architectural compatibility between the front yard landscape and the primary structure is strongly encouraged.

City of San Marino

RESIDENTIAL DESIGN GUIDELINES



- Visual openness should be maintained in the front yard.
- Front yards should be visual from public view by avoiding “fencing-in” the front yard especially with fence or hedge materials.
- A minimum of one tree per fifty feet of lot width should be maintained in the front yard in addition to street tree(s).
- Concrete, tiles or other permanent paving materials are encouraged for use on driveways, walkways or circular drives, in the front yard. Asphalt is strongly discouraged.
- Landscape architectural features such as fountains, pilasters, walls, and fences should be compatible with the architectural style of the house.
- The scale of proposed landscape materials should be proportional to the size of the primary structure.
- Landscape color should provide contrasts within itself yet be architecturally compatible with the primary structure on the lot.

2. Preservation of Existing Trees: Established trees contribute to the character of the city and to each residential structure. The City’s tree ordinance defines an established tree and the requirements for removal and pruning. A city permit is required for substantial trimming or removal of certain trees. For information about tree trimming or removal permits, contact the Planning and Building Department. The following are guidelines regarding tree preservation:

- The design and siting of a dwelling or accessory structure should take into account all established trees in order to avoid unnecessary removal, cutting and trimming.

Tree Preservation

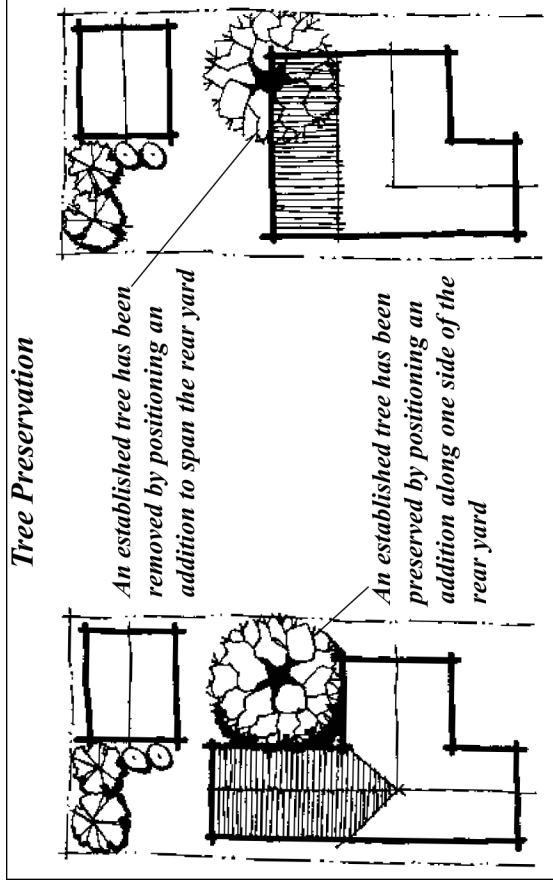

- The root systems of established trees should be protected when siting a dwelling or accessory structure and during construction. Avoid extensive topsoil removal from the building site, as it provides essential nutrients to existing trees.
 - Gravel or other permeable materials should be used whenever possible for paths, walkways and areas of driveways in close vicinity of established trees to allow for tree root expansion.
 - Chimneys should not be located near existing established trees because they could negatively affect the surrounding tree canopy.
- 3. Architectural Consistency and Compatibility:** Landscape can greatly enhance and accentuate the architecture of the primary structure. To maintain architectural consistency and compatibility of the entire property, landscaping should complement the architectural style and design of the primary structure and should be compatible with the neighborhood. The following are guidelines for maintaining architectural consistency and compatibility in landscape design:



RESIDENTIAL DESIGN GUIDELINES

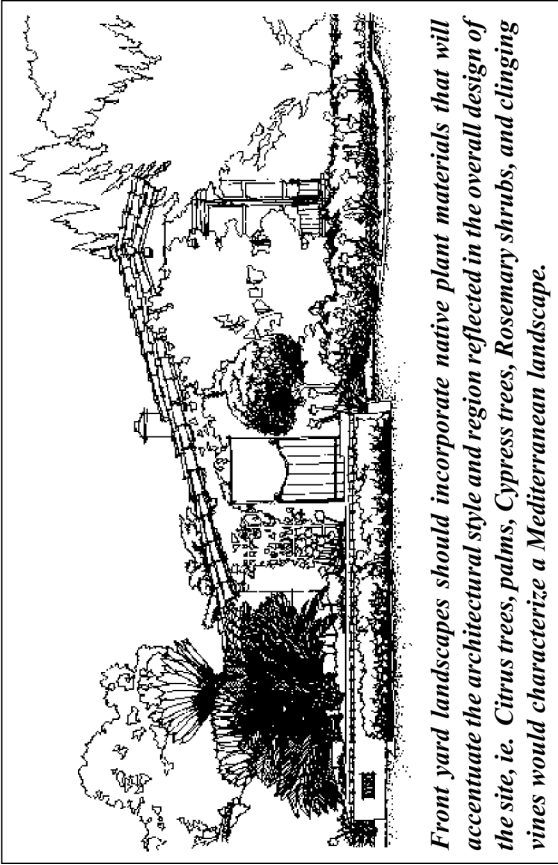

Front yard landscapes should incorporate native plant materials that will accentuate the architectural style and region reflected in the overall design of the site, ie. Citrus trees, palms, Cypress trees, Rosemary shrubs, and clinging vines would characterize a Mediterranean landscape.

ENCOURAGED

- Paving material for driveways and walkways should be consistent with the architectural style of the home and incorporate its accent elements. Paving material should also complement the existing landscape and link the hardscape with the primary structure.

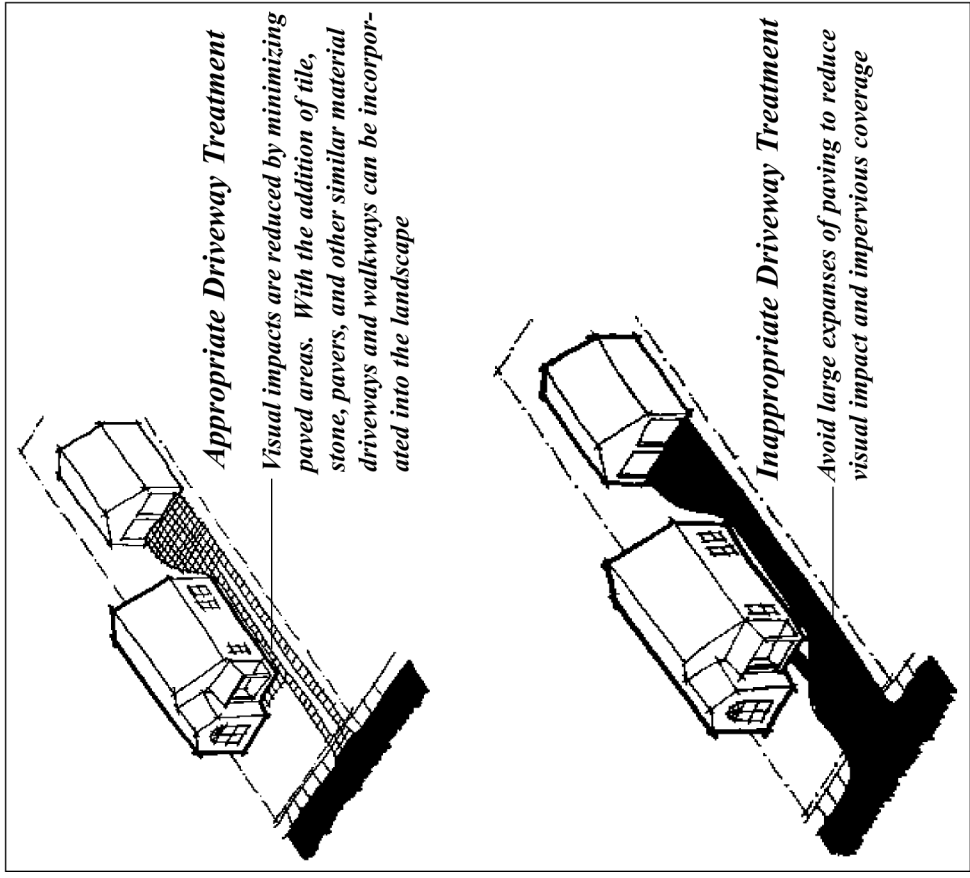

- Landscape elements including walkways, driveways, garden walls, fences, gates, lighting and furniture should match the architectural style of the primary structure.
- The design of landscape elements pertaining to form, horizontal and vertical lines, hardscape and softscape, and ornate qualities should complement the design of the primary structure.
- Appropriate materials, texture and color of landscape elements should be compatible with those of the primary structure.

4. **Driveways and Walkways:** In keeping with the natural character of San Marino, driveways and walkways should complement the home while maximizing the amount of landscaping and minimizing the amount of paving. The following are guidelines for appropriate materials, design, and placement of driveways and walkways:

RESIDENTIAL DESIGN GUIDELINES



DISCOURAGED

- To minimize extensive use of concrete, driveways are encouraged to incorporate natural materials into their design with the use of brick pavers, stone, decomposed granite, turf block, or landscaping within the form of “two-panel” driveways.
- Natural materials such as brick pavers, stone, decomposed granite, tiles, and textured or stamped concrete for walkways are strongly encouraged.
- The color of paving materials for driveways and walkways should be an earth tone.
- Reduction in driveway width with the use of decorative paving to minimize a hardscape’s visual impact is encouraged.
- The walkway should be designed at a human scale and not be confused as an alternative driveway.
- Placement of driveways and walkways should be designed to provide direct access paths to garages and front entries.

- Asphalt and the extensive use of concrete for driveways and walkways are strongly discouraged.

- Bright and/or glossy paving materials should be avoided.

Applicants should check the Zoning Code for maximum impervious coverage requirements for front yards.

- 5. **Fences, Walls, Gates and Hedges:** Fences, walls, gates and hedges are primarily used for privacy, for side yards and back yards. To maintain the quality of openness that exists in San Marino, front yard landscapes are strongly encouraged to be free of perimeter fences, walls, and hedges in the front yard. The following are guidelines for appropriate design and placement of fences, walls, gates and hedges:

- Fences and gates should be designed with simplicity to complement the home. Avoid ornate fences and gates, which draw attention, and detract from the main structure.
- The materials, design, height, and length of the fence or wall should be compatible with the architectural style, materials and overall size of the primary structure.
- Front yard fences in neighborhoods where there are no existing fences in the front yard are strongly discouraged.
- Setbacks of fences and walls should reflect the distance of the primary structure set back from the street. Fences and walls are encouraged to be setback from the property line in the front yard at an optimum of ten feet and a minimum of five feet.

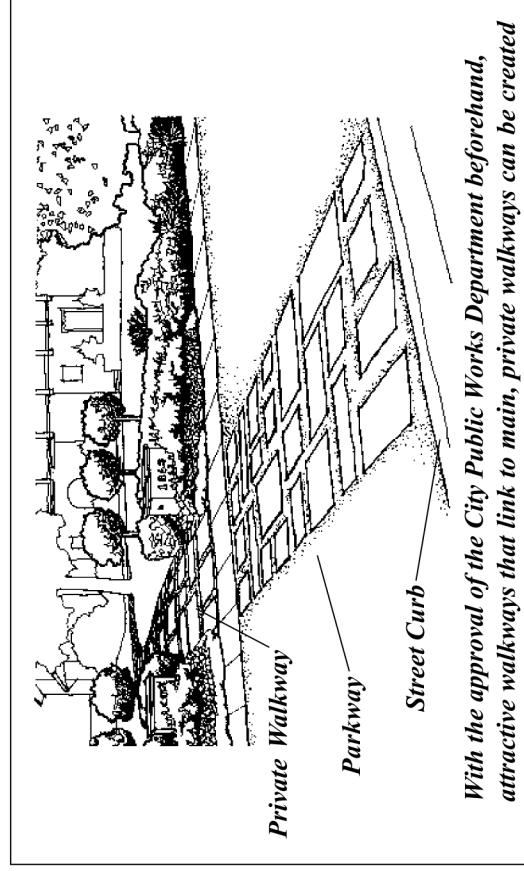

RESIDENTIAL DESIGN GUIDELINES



Appropriate Front Yard Fencing

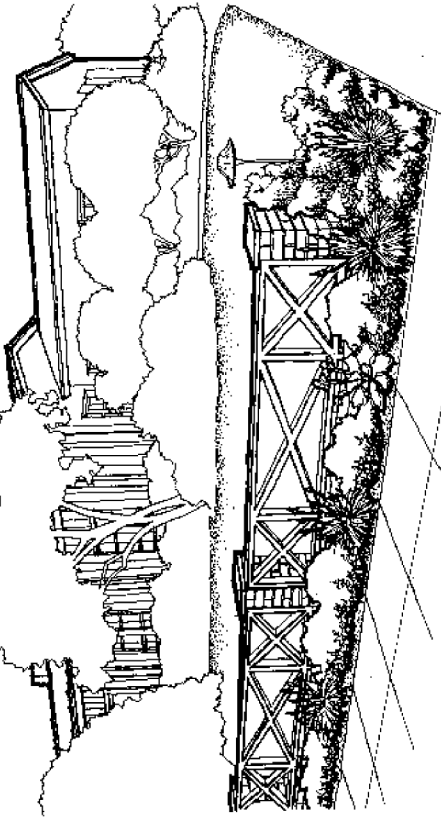

Fencing is setback the required distance from the property line, is largely open, and is architecturally compatible with the main structure

- Front yard fences and walls should provide a decreasing level of opaqueness as the height of the fence or wall increases.
- Landscaping should be included as a part of the design for the fence or wall or the fence or wall should be integrated with the landscaping on the site. Total infill of wrought iron fences with hedge-type plant material is inappropriate.
- Pilasters and other architectural features such as posts should be architecturally compatible with the primary structure.
- Spike-tipped fencing is prohibited by city code. The use of true wrought iron is encouraged as opposed to metal tubing.

Applicants should note the Zoning Code for all fencing, wall, and hedge requirements.

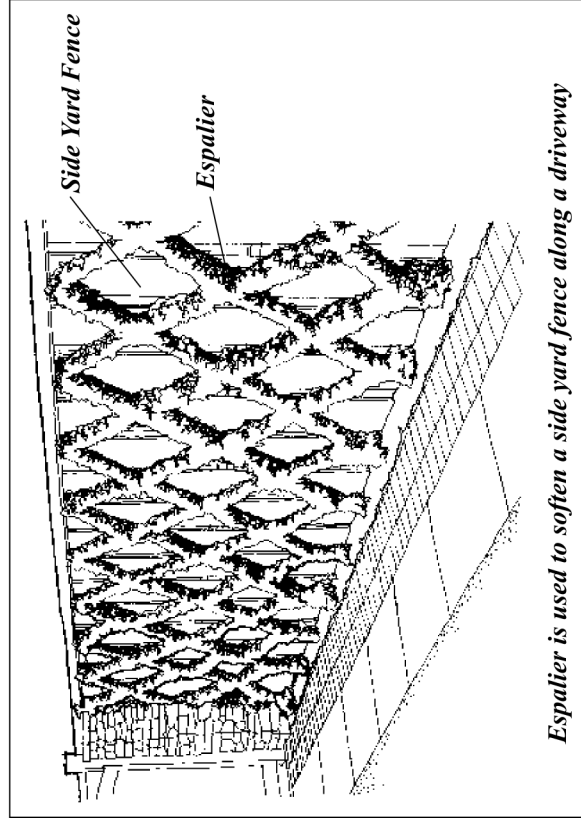

Espalier is used to soften a side yard fence along a driveway

- Gates should be designed to reflect the architecture of the primary structure and the style and design of the fence or wall.
- Hedges which are intended to provide screening and privacy should be planted in a manner without encroaching over the sidewalk or front property line if no sidewalk exists.

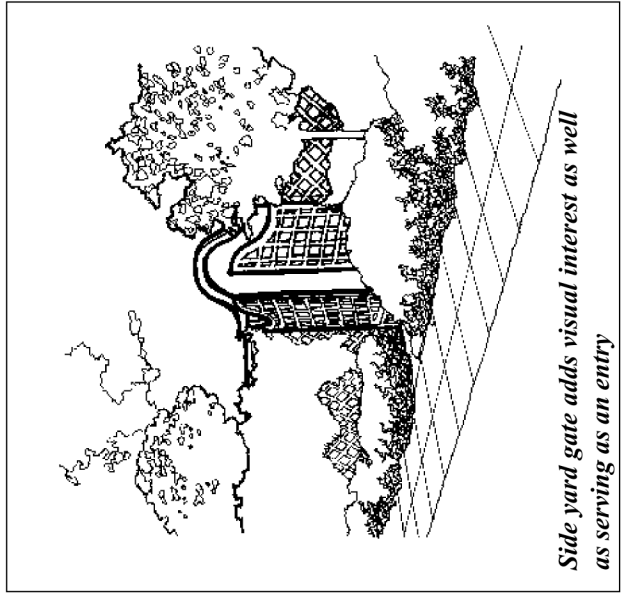

Side yard gate adds visual interest as well as serving as an entry

RESIDENTIAL DESIGN GUIDELINES



6. Landscape Accessories: Landscape accessories pertain to ornamental elements seen in front yards and near the facade of the primary structure. These elements, when appropriately designed and incorporated as part of an overall concept, can accentuate the landscape and the architecture of a structure.

a. Pools, Fountains, Statuary and Pilasters: Pools, fountains, statuary and pilasters are examples of the landscape elements seen in the front yard. Their design and placement usually relate closely to the architecture of the primary structure. Their purpose is strictly aesthetic. The following are guidelines for appropriate design and placement of these elements:

- The design of pools, fountains, statuary, and pilasters should be compatible with the primary structure.
- The design of pools, fountains, statuary, and pilasters should reflect good taste and compatibility with the neighborhood. They should accentuate and complement the front yard and not be designed to distract attention from the primary structure.
- Pilasters should be made from materials consistent with the materials of the house. Pools, fountains, and statuary should be made from high quality concrete and make a simple, clear statement.
- Pools, fountains, statuary, and pilasters should be placed in an area that complements the natural topography of the site, the landscape of the property and the primary structure. They should not be located in a front lawn as an isolated element.

Appropriate Usage of Landscape Accessories

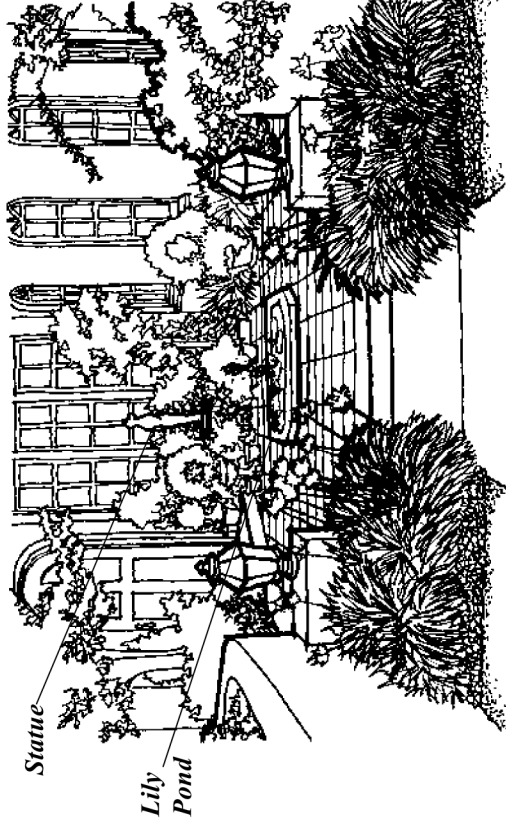

The use of short garden walls and landscaping creates an intimate courtyard with a small, but tasteful lily pond. A statue and potted plants are placed in the landscaping suggesting the idea that they are an integral part.

Inappropriate Usage of Landscape Accessories

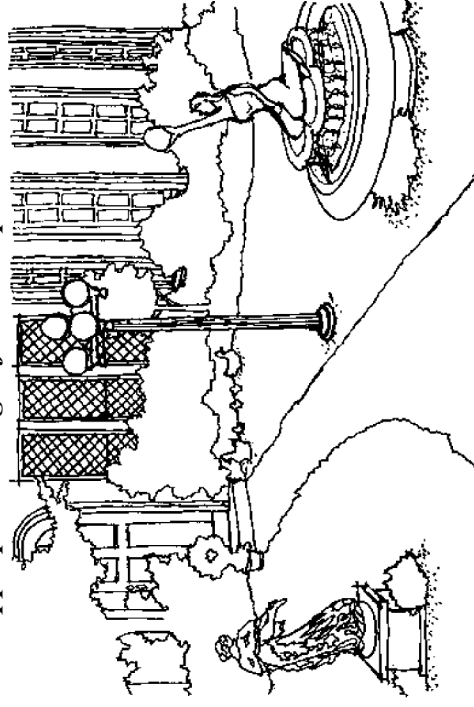

Landscape accessories should reflect good taste and architectural compatibility with the main structure



RESIDENTIAL DESIGN GUIDELINES

- b. Mailboxes and House Address Numbers:** While mailboxes and house address numbers have a functional purpose, they can be highly visible elements from public view. The following are guidelines for appropriate design and placement of mailboxes and address numbers:

 - Mailboxes are encouraged to have a simple design and be architecturally compatible with the architectural style of the primary structure.
 - Address numbers should be a minimum of 4 inches in height and should be located near the front entry door or front entry porch in a location that is visible from public view.
 - The design of the numbers should be simple in shape so that they can be read easily from a distance.

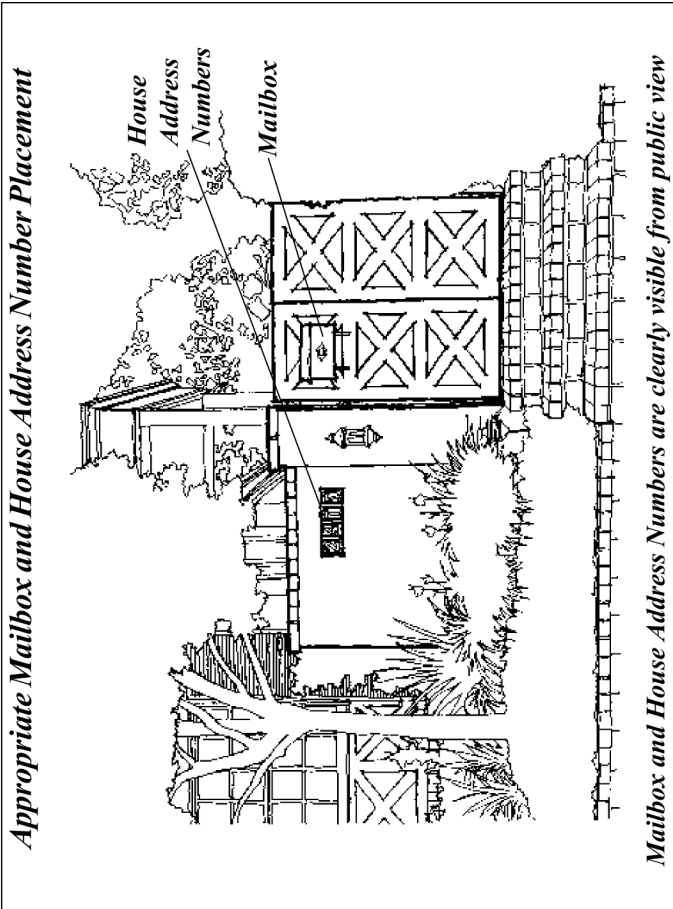

- Number colors should provide a strong contrast with background color.
- Address number illumination is encouraged.

7. Tennis Courts: Tennis courts have requirements for their design and placement in the city code. The following are guidelines for appropriate design and placement of tennis courts and their related landscape elements:

- Tennis courts should be screened from public view and sited in a remote location of the property so that they are unobtrusive to adjacent neighbors.
- Tennis courts should be screened with tall hedges or trees to buffer noise and light. Solid perimeter walls are discouraged because they amplify court noise.
- Accessory structures, such as pergolas, should be architecturally compatible in style, design, materials, color and texture with the primary structure.
- Surface water should be designed to drain away from neighboring properties and into the public street.

Tennis courts require a Conditional Use Permit. For additional information regarding the Conditional Use Permit process and code requirements for tennis courts, please contact the Planning and Building Department.

RESIDENTIAL DESIGN GUIDELINES



8. Landscape Lighting:

Landscape lighting involves lighting methods and tools that are used to complement and enhance the architecture and landscape on a property. Lighting for a landscape scheme should be functional and aesthetically pleasing while providing a sense of security. The following are guidelines for appropriate design of landscape lighting:

- Landscape lighting should be designed so that the light source is not visible. Lighting fixtures should be screened behind landscape features and designed to be compatible with the architectural style of the primary structure.
- Illumination should be minimal and not flood the landscape with excessive light or spill into adjacent properties.
- Lighting design should create a balance between illuminated

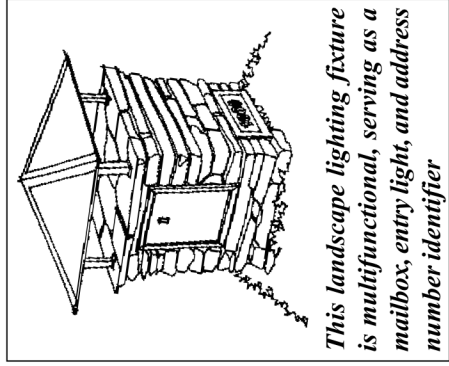

and non-illuminated areas.

- Landscapes should utilize recessed uplighting to illuminate planting and various landscape elements and discrete floodlights to accentuate building facades and architectural details. Uplighting on walls of the structure help define space and create visual interest, while providing comfort and security.
- Lighting should create a nightscape scene highlighting horizontal elements such as walkways, level changes, and pools, and dramatic, vertical elements such as trees, shrubs, pilasters, statuary, and fountains.
- The use of very inexpensive low-voltage lighting (such as “Malibu” lights) with many small fixtures scattered about is discouraged.

Uplighting is used to add visual interest to the landscape at night. Landscape Light Fixtures are complementary to the house.

RESIDENTIAL DESIGN GUIDELINES

APPENDIX A: Glossary of Terms

ACCESSORY STRUCTURE - a structure detached from a principal building on the same lot and customarily incidental and subordinate to the principal building; examples would be a detached garage, workshop, pool house, or garden shed.

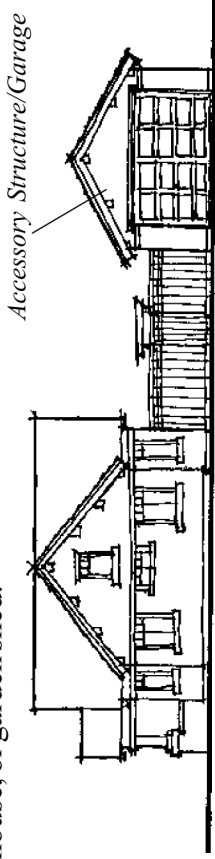

AESTHETIC - Sensitive to art and beauty and its creative sources, forms and effects.

ARCHITECTURAL STYLE - A fashion in which elements of a structure's forms, materials, etc., creates a design which can be identified as a particular style. This can include the style of the building which existed when that building was constructed.

ARCHITECTURAL HERITAGE - The original style of a place or building which has specific characteristics, traditions and details.

ARTICULATION - Clear and distinct separation between design elements such as materials, walls and architectural details.

ARTS AND CRAFTS - a late 19th century English movement to revive and reform architecture by using traditional building crafts and local materials. (See page 28)

Articulation

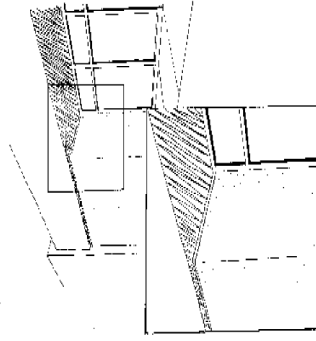

An example of articulation is the separation of a rough stucco plane (side of the building) to a smooth wood plane (the ceiling of recessed frontage) within the same facade

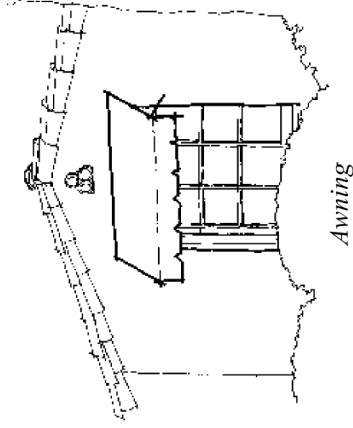

Awning

AWNING - a fixed cover, typically comprised of cloth over a metal armature, that is placed over windows or building openings as protection from the rain or sun.

BALANCE- Is an important aspect of rhythm. Balance can be described in terms of symmetrical and asymmetrical elements. An important feature of balance is that it is very often achieved by matching differing elements which, when perceived in whole, display balance.

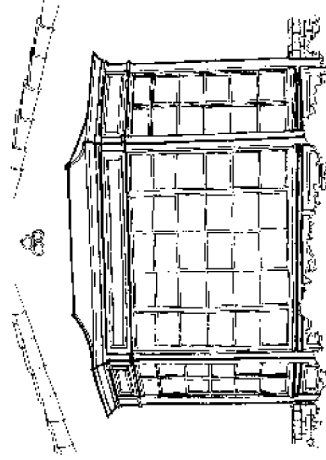

BAY WINDOW - a window projecting outward from the main wall of a building.

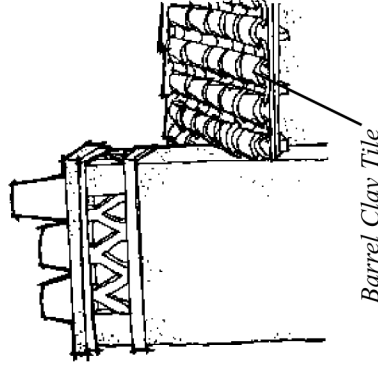

Barrel Clay Tile

BARREL CLAY TILE - a type of roof material made of ceramic clay typically seen on Spanish Colonial, Mission and Mediterranean style homes.

BEAUX ARTES - a very rich classical style of architecture from late 19th century France; a notable local example is the Huntington Mansion at the Huntington Library and Botanical Gardens, San Marino, CA. (See page 1)

RESIDENTIAL DESIGN GUIDELINES

CAPE COD STYLE - Architectural style made popular in New England waterside communities. Style is typified with heavy, dark wood shake exterior siding, high-pitched, heavy wood shake roofs, dormers, shutters, front porches, brick chimneys, and simple cornice moldings. (See page 12)

CANTILEVER - A beam or architectural element projecting beyond a wall line without support from below.

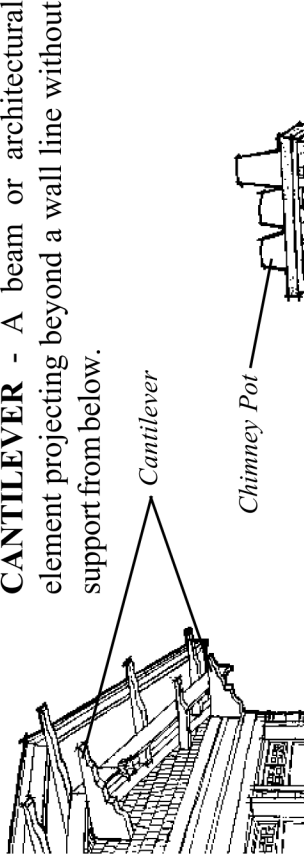

CHIMNEY POTS - Decorative, round or octagonal ceramic feature placed on top of the chimney stack commonly found on chimneys in Tudor style buildings.

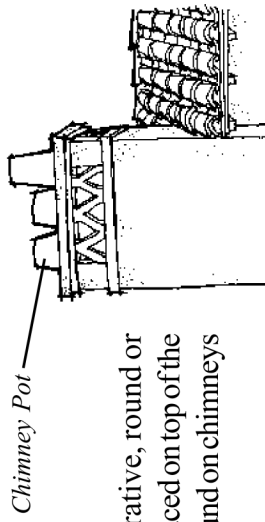

CLADDING - An external covering or skin applied to a structure for aesthetic or protective purposes.

CLAPBOARD SIDING - Overlapping horizontal boards covering a wall that are traditionally wedged in section with the upper edge being thinner.

CLINKER BRICK - Type of ceramic brick with varying hues of color commonly seen exposed on Tudor style buildings.

COLONIAL REVIVAL - Broad category of varying architectural style seen in the United States from the Seventeenth Century to the Early Twentieth Century. (See page 10)

COMPATIBILITY - Having an architectural style, visual bulk, massiveness, height, width, and length which is compatible with the neighborhood and which harmonizes with existing structures in the neighborhood and within itself.

COMPLEMENT - In new construction it means to add to the character of the area by attempting to incorporate similar setback, height, scale, massing, and materials.

CONDITIONAL USE PERMIT - A permit allowing a use under specified conditions which assure that use will not be detrimental to the public health, safety, and welfare and will not impair the integrity and character of the zoned district.

CORNICE - In classical architecture, the top, projecting section of an entablature, any projecting ornamental molding along the top of a building, wall, arch, etc., finishing or crowning.

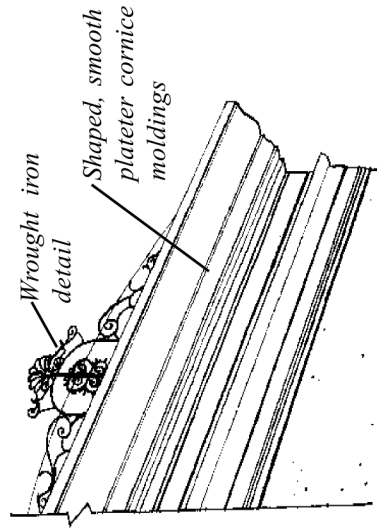

COURTYARD - An uncovered area partly or wholly surrounded by buildings or walls.

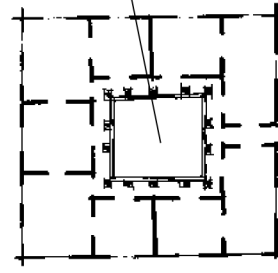

Plan View of First-Floor Residence

CRAFTSMAN - A style of architecture, termed in California starting from the late 1890s to the 1920s, derived from the Arts and Crafts Movement, referring to the style of home,

RESIDENTIAL DESIGN GUIDELINES



Bungalow or Chalet, having roofs with large overhangs and exposed rafter tails, wood clapboard or shingle siding, and large front porches with exposed brick or river rock foundations.

CURB APPEAL - view from the street

DETAIL - An element of a building such as trim, moldings, other ornaments, or decorative features.

DESIGN CONTINUITY - The state or quality of a design being continuous, connected and having coherence.

DEVELOPER TRACT - Typically a group of homes or subdivision built and developed by one person, group or entity, the Developer, all at the same time with little or no varying architectural style, design, site placement, or elements.

DORMERS - A vertically framed window which projects from a sloping roof and has a roof of its own.

DROUGHT TOLERANT PLANTS - Plants typically native to the Southern California landscape requiring little or no supplemental water.

DUTCH COLONIAL REVIVAL - A revival of the style of architecture seen in the United States, specifically in the Dutch colonies of the early Seventeenth Century, typified with side-gabled roofs with dormers and little or no overhang. (See page 25)

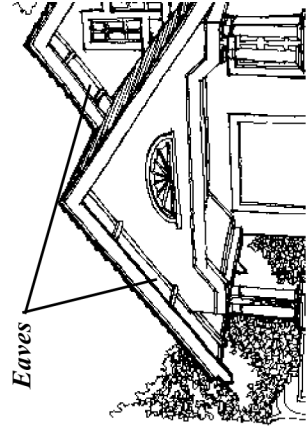

EAVES - The overhangs at the lower edge of a roof which usually projects out over the walls.

EARTH TONES - Color combinations found in the natural landscape.

ECLECTIC - A composition of elements from different architectural styles.

EMPHASIS - Describes the use of elements that call attention to themselves. Emphasis is an important feature in creating balance when using dissimilar elements. Emphasis can also provide a directional guide because it creates a point of reference for the user such as the main entrance of a building.

ENERGY EFFICIENT - A method of conserving energy consumption and usage with practices and equipment that use energy, fossil fuels, natural gas, and electricity, efficiently.

ENTABLATURE - The upper part of an order, consisting of a frieze and cornice.

ENVIRONMENTAL SENSITIVITY - Practices that reduce the impact of energy and materials consumption on natural systems.

ESTABLISHED TREE - A planted tree at least fifteen (15) feet tall and having a trunk with a width of twenty-four (24) inches in diameter, as per the requirements set forth in the City's Tree Preservation Ordinance.

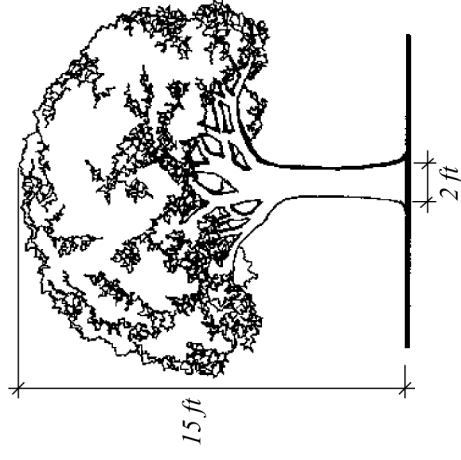

EUROPEAN STYLE - Includes architecture which emphasizes materials such as stucco, red tile roofs, wood and iron details. The designs also promote the use of out door

RESIDENTIAL DESIGN GUIDELINES

space such as courtyards, colonnades, and balconies. These styles include, but are not limited to, Spanish Mediterranean, Mission, Monterey, and Italian Renaissance.

FACADE- The exterior portion of a building which faces a public street. Said portion generally consists of a solid wall, glass or other building materials. The facade is usually emphasized architecturally.

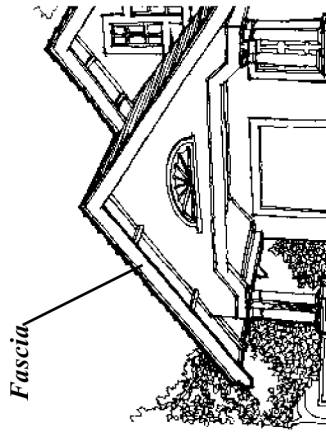
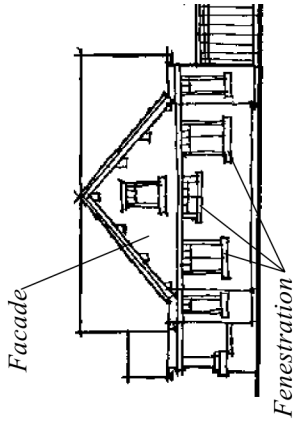

FASCIA - A flat strip or band with a small projection, often found near the roofline.

FENESTRATION - The arrangement and design of windows in a building. (See Facade above)

FRENCH ECLECTIC- An eclectic style of French architecture seen in the United States from the early to the middle Twentieth Century, typified with tall, steeply pitched hipped roofs, upwardly flared eaves, and brick, stone or stucco wall cladding.

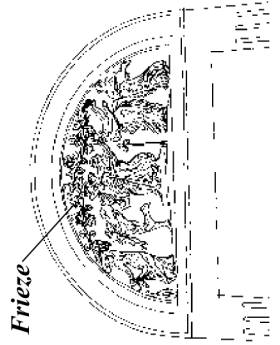
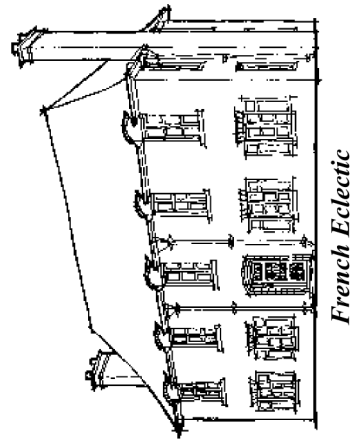

FRIEZE - A decorative sculptural ornament which is very flat and shallow.

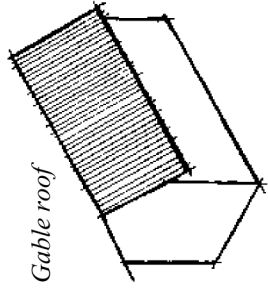

GABLE - A roof with two sloping planes supported at their ends by triangular upward extensions of two walls known as gables.

GLAZED WINDOWS (DUAL/SINGLE) - term referring to the glass pane of a window. Dual glazing refers to two panes of glass for a single window, as single glazing refers to one pane of glass for a single window.

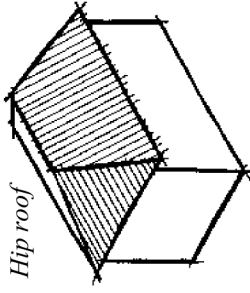

HALF-TIMBERING - Decorative, exposed timber framing on the exterior of most Tudor style buildings.

HIP ROOF - A roof with uniformly sloped surfaces.

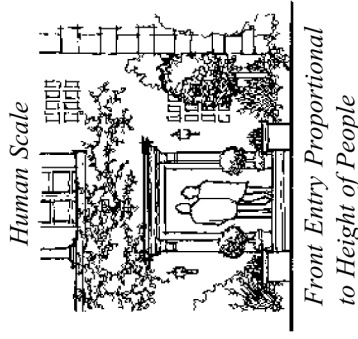

HUMAN SCALE - The proportion of a structure or elements within a structure that are small and/or lower to the ground, relative to the size of a person, creating similarity in scale. These are commonly referred to as intimate spaces or elements because of the close relationship of a human being to the space or element.

HVAC SYSTEMS-Heating, Ventilation, Air Conditioning unit.

IMPERVIOUS COVERAGE - Any hardscape material prevents absorption of water into previously undeveloped land, such as concrete.

INTERNATIONAL - Style of architecture from early Twentieth Century Europe, typified by asymmetrical compositions, plain cubic forms, and

RESIDENTIAL DESIGN GUIDELINES



metal and glass framework.

MASS- Describes three dimensional forms, the simplest of which are cubes, boxes, cylinders, pyramids, and cones. Buildings are rarely one of these simple forms, but generally are composites of varying types of masses.

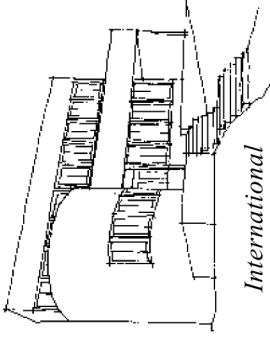

International

MINIMAL TRADITIONAL - Eclectic, modern style of architecture that became popular after World War II, typified by simple, unadorned facades and low-pitched roofs, usually with at least one front-facing gable and a chimney. (See page 13)

MISSION - Eclectic style of architecture popular in California from the 1890s to 1920s modeled after the Spanish Colonial mission buildings, typified by red tile roofs with wide, overhanging eaves, and shaped Mission dormers or parapet walls and wall surfaces with smooth stucco.

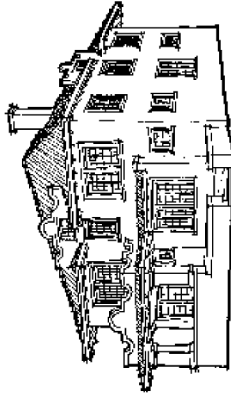

Mission

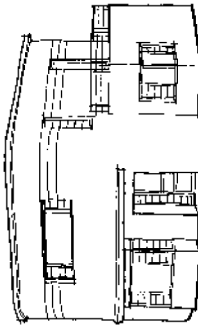

Modernistic

MODERNISTIC - Style of architecture from the 1920s to 1940s, including Art Moderne and Art Deco styles, typified by flat roofs, asymmetrical facades and smooth stucco wall surfaces. Art Deco and Moderne styles have facades adorned with ornamental elements such as horizontal grooves, lines, zigzags and other geometric and stylized motifs, depending upon style.

MOLDINGS - Projecting materials usually patterned strips, used to

provide ornamental variation of outline or contour, such as cornices, bases, window and door jambs and headers.

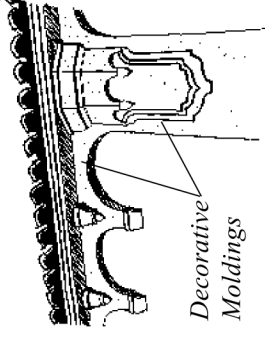

Decorative Moldings

MONTEREY PERIOD REVIVAL - Eclectic style of architecture influenced by Spanish Colonial houses of Northern California from 1925 to 1955, typified by a two story building with a low-pitched, gabled roof and a second-story, front balcony, usually cantilevered and covered by the principal roof. (See page 10)

MULLIONS - The divisional pieces in a multi-pane window.

NATURAL MATERIALS - Building materials made of resources found in nature; ie. wood, clay, slate, stone.

NEOCLASSICAL - The eclectic style of architecture from the late Nineteenth Century to the middle Twentieth Century modeled after the Classical styles of Greek Revival from the Early Nineteenth Century. It is typified by a facade with symmetrically balanced windows and center door and dominated by a full-height porch supporting the roof by classical columns. (See page 11)

NON-DESCRIPT - Without distinctive architectural form or style. Ordinary and without architectural style or character.

PERMEABLE SURFACES - Any material that permits full or partial absorption of water into previously unimproved land.

Pilasters

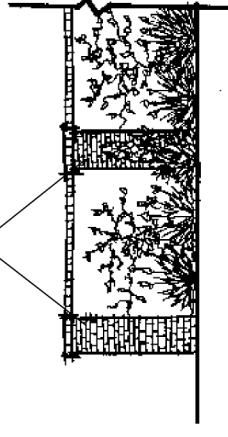

PILASTER - A column attached to a wall or independently standing.

RESIDENTIAL DESIGN GUIDELINES

PITCH - The slope of a roof expressed in terms of a ratio of height to span.

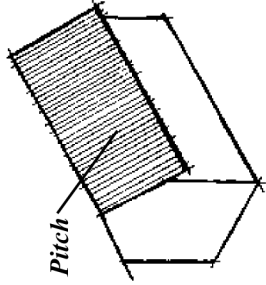

PLAN CHECK - The process of having working drawings approved by the City contracted structural engineers, the Fire Department, the City Engineer, and the City Planning and Building Department.

PLANES - A flat level or even surface that wholly contains every straight line joining any two points lying in it.

PRAIRIE SCHOOL - Architectural movement in American Midwest between 1900 and 1916 mostly with residential buildings, typified by horizontal lines, open space, and usage of natural materials. (See page 15)

PRIMARY STRUCTURE - The main, usually largest, structure on a lot. In residential zones, it is the main residence.

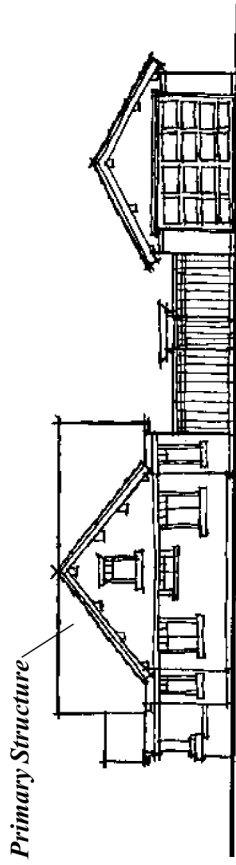

PROPORTION - Deals with the ratio of dimension between elements. Proportion can describe height to height ratios, width to width ratios, width to height ratios, as well as ratios of massing. On a larger level, proportion can be perceived in the Commercial Districts as a whole by the relationship of buildings and streetscape elements to each other.

PUBLIC HEARING - A meeting open to the public which has been

legally noticed and a decision making body presides; ie. Planning Commission, DRC or City Council.

PUBLIC VIEW - The visual range of a property from the public right-of-way.

RAFTER TAIL - The exposed section of the rafter or sloping structural member of the roof that extends from the ridge to the eaves and is used to support the roof deck, shingles, or other roof coverings.

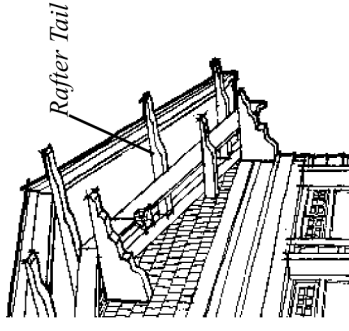

RANCHHOUSE - The style of architecture made popular in the United States during the 1940s to 1960s, typified by one story, asymmetrical shapes, low-pitched roofs, and wood clapboard siding. (See page 12)

REMODELING - Any change or alteration to a building which substantially alters its original state.

RENOVATION - To make like new again, but not necessarily preserving the architectural integrity of the original.

RESTORATION - To put back exactly to an original state, or to put back to a significant style not necessarily the original.

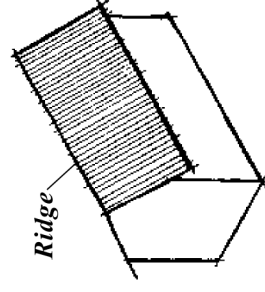

RIDGE - The highest line of a roof where sloping planes intersect.

RHYTHM - The relationship of buildings to buildings or the components of a building to each other. Rhythm relates to the spacing of elements and can be described in terms of proportion, balance, patterns in the timing, spacing, repetition, accenting, and emphasis.

RESIDENTIAL DESIGN GUIDELINES



SCALE - Is the measurement of the relationship of one object to another object. The scale of a building can be described in terms of its relationship to a human being. All of the components of a building also have a relationship to each other and to the building as a whole. Generally, the scale of the building components also relates to the scale of the entire building.

SETBACK - The minimum distance required by zoning to be maintained between two structures or between a structure and a property line.

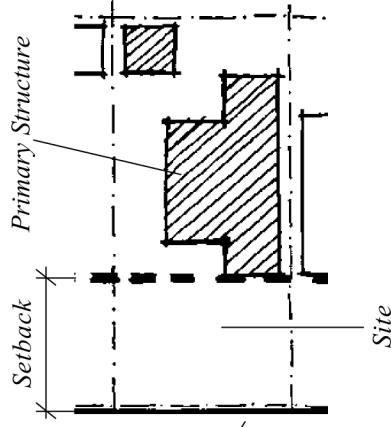

SIDING - Exterior wall covering of horizontal boards nailed to a wood frame.

SITE - The geographic location of a construction project, usually defined by legal boundaries.

SKYLIGHTS - A window set into a roof or ceiling to provide the entrance of natural light into a structure.

SPANISH COLONIAL REVIVAL - A style of architecture also referred to as Spanish eclectic. This style dates from 1915-1940. The features of this style include a low pitched roof, usually with little or no eave overhang; red tile roof; typically with one or more prominent arches placed above door or principal window, or beneath porch roof; wall surface usually stucco, facades are normally asymmetrical. Not to be confused with the similar styles which include, Monterey, Mission, or Mediterranean/Italian Renaissance. (See page 9)

STREETSCAPE - The elevation of a residential block which includes

primary and accessory structures, landscaping, and other improvements visible from the street.

STUCCO - An exterior finish, usually textured, composed of portland cement, lime and sand, which are mixed with water.

SYNTHETIC MATERIALS - Man-made materials, some of which are designed to simulate natural materials.

TASTEFUL - Having or showing good judgement in what is beautiful, appropriate, harmonious, compatible or excellent in art, architecture, decoration, etc.

TEXTURE - Refers to variations in the exterior facade finish and may be described in terms of the roughness of the surface material, the patterns inherent in the material or the patterns in which the material is placed.

TIMELESS - Something which is not restricted to a specific time and which is always valid true, traditional, or applicable.

TRANSITION - A passage connecting two sections of composition conditions or forms.



TRANSOM - An opening over a door or window, usually for ventilation, containing a glazed or solid sash, usually hinged or pivoted.

TREE CANOPY - the natural shelter or covering created by a tree or group of trees in a forested area spreading from one end of the tree to the other end.

RESIDENTIAL DESIGN GUIDELINES

TRELLIS - An ornamental structure of lattice work over which vines are trained, usually made of narrow strips of wood which cross each other at regular intervals.

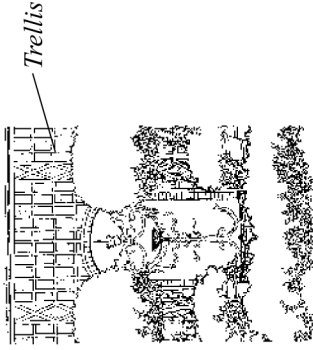

TRIM - The finished woodwork, plasterwork or the like used to decorate, border, or protect the edges of openings or surfaces.

TUDOR - Eclectic style of late Medieval, English architecture seen in the United States from the late Nineteenth Century to the middle Twentieth Century, typified with steeply pitched, wood shake/shingle roofs, brick exterior facades with portions half-timbered, and massive, decorative chimneys. (See page 11)

UPLIGHTING - Landscape lighting technique of placing a sunken light source below ground, often hidden from view, to upwardly light certain architectural and landscape elements, such as building facades and specimen trees and plantings.

VARIABLE SETBACK (FOOTPRINT) - An outline of the ground area within a site covered by a structure that deviates from a square or rectangular shape.

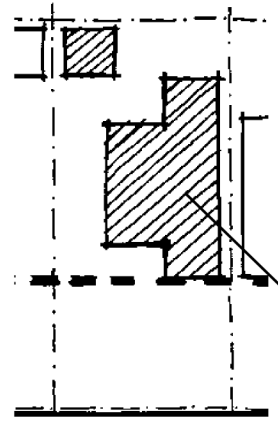

Variable Setback (Footprint of Building on Ground Floor)

VARIANCE - Permission to depart from the literal requirements of a zoning ordinance. To grant a variance, findings must be made by a local decision making body, such as the Planning Commission, that a hardship would exist if a variance was not granted and that granting the variance would not constitute a special privilege.

VICTORIAN - Style of architecture from the late Nineteenth Century brought to the United States from England, typified with steeply pitched, gabled roofs, decorative shingle patterns, and ornate porch details.

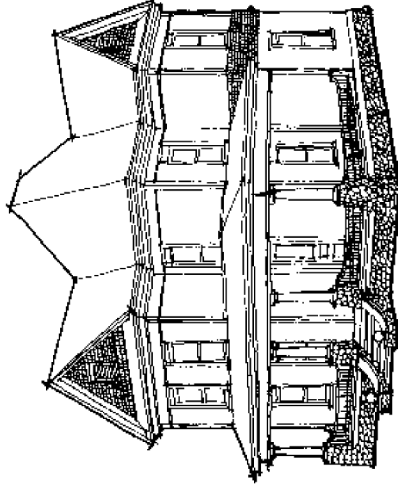

Victorian

VINYL-CLAD WINDOWS - A window with a vinyl coating over the wood frame and mullions.

VOLUME - Cubic square footage of an area measured as the length times the width times the height of the area.

WINDOW LITES - A window pane made of glass.

RESIDENTIAL DESIGN GUIDELINES



RESIDENTIAL DESIGN GUIDELINES





APPENDIX B: Obtaining Design and Construction Assistance

Before beginning the Design Review Process, an applicant should consult an architect or other design professional for the preparation of detailed architectural plans that will be required for submittal for design review.

After discussing an applicant's plans for their project with the City's Planning and Building Department, the applicant will need to develop designs for the project. A design can be done by one or more of the following:

- The applicant
- An architect
- An engineer (for major foundation, structural, or mechanical issues)
- A design-build remodeler
- A subcontractor who can produce plans
- A building designer

Once the applicant has gone through design review and is ready to begin construction by acquiring the necessary building permits, the applicant will need to decide if a building contractor is necessary for the level of construction that will be occurring. The following section provides basics guidelines to selecting an architect or design professional and building contractor.



HOW TO SELECT AN ARCHITECT OR OTHER DESIGN PROFESSIONAL?

The following should be taken into account when selecting an architect or similar design professional:

- Education and professional credentials (AIA, ASLA, etc)
- Necessary licensing and insurance
- Business experience, length of practice
- Related experience, percentage of practice involved in designing the type of structure the applicant is proposing
- Examples of work and references
- Services provided during the design, bidding, and construction phases
- Fee schedule and overall cost of service
- Additional charges for unseen changes in design
- Meeting required time schedule and budget
- Experience presenting plans before a local-decision making body on a public hearing environment

HOW TO SELECT A BUILDING CONTRACTOR?

The following should be taken into account when selecting a building contractor:

- Education
- Necessary licensing and insurance
- Business experience, length of practice
- Related experience, percentage of practice involved in building the type of structure the applicant is proposing
- Examples of work and references
- Management and Coordination skills with subcontractors
- Fee schedule and overall cost of service
- Additional charges for unseen changes in design and construction
- Meeting required time schedule and budget

RESIDENTIAL DESIGN GUIDELINES





APPENDIX C: Information Resource List

ARCHITECTURAL DESIGN RESOURCE BOOKS

- Blumenson, John; *Identifying American Architecture: A Pictorial Guide to Styles and Terms, 1600-1945*. Nashville: American Association for State and Local History, 1981.
- Carley, Rachel; *The Visual Dictionary of American Domestic Architecture*: Owl Book Press, 1997.
- Fletcher, Sir Bannister; *A History of Architecture*. Nineteenth Edition: John Musgrove, Butterworth Group, 1987
- Huxtable, Ada Louise; *The Unreal America, Architecture and Illusion*: The New Press, 1997
- Kirker, Harold; *California's Architectural Frontier*, Santa Barbara: Peregrine Smith, Inc., 1974.
- McAlester, Virginia and Lee; *A Field Guide to American Houses*, New York: Alfred A. Knopf, 1984
- Norberg-Schultz, Christian; *Old and New Architecture, Design Relationship*. Washington, DC: The Preservation Press, 1980.
- Pevsner, Nicholas; *A Dictionary of Architecture*: John Fleming, Hugh Honour, The Overlook Press, 1976
- Speltz, Alexander; *The Styles of Ornament*: Dover Publications, 1959, reissued periodically (paper)

Whiffen, Marcus; *American Architecture 1607-1945*. Cambridge: MIT Press, 1981

WEBSITE RESOURCES:

American Institute of Architects, How to find the Right Architect. <http://www.aiaaccess.com/profiles/>

City of San Marino homepage <http://www.ci.san-marino.ca.us/>

The Great Building Collection- A Menu of Architectural Types <http://www.greatbuildings.com>

Oachinero, Tony; *Energy Resource Center; Southern California Gas Company*: Residential Marketing Manager 213-244-3880
Resources for residential energy conservation and sustainable building materials

<http://www.socalgas.com/erc>

Southern California Edison; *Home Interiors- Money Savers Website*: <http://www.edisonathome.com/homescd/save/index.htm>
Customer Service Center: <http://www.sce.com>.

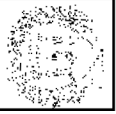

RESIDENTIAL DESIGN GUIDELINES

RESIDENTIAL DESIGN GUIDELINES



APPENDIX D: Building Project Checklist

The following items on this worksheet relate to the recommendations set forth in the City of San Marino's Residential Design Guidelines. Working through these items will help you to explore important design considerations as you prepare your project for design review submission. You are strongly encouraged to meet with City staff before prepare plans for design review submittal. This will help you identify applicable requirements ahead of time and avoid costly and time-consuming problems later on in the process.

It will also be helpful if you have a prepared site plan of your property and a completed "Plan Information Sheet". The latter is available at the Planning Department in Cityhall. The site plan should accurately depict your property boundaries, public and private easements, public right-of-ways, existing structures, driveways, walkways, and trees.

PROJECT ADDRESS: _____

Area District: _____

Type of Project: New Home
 Addition or remodel
 New Accessory Structure

Building Height:

Maximum allowed : _____ ft.
 Proposed : _____ ft.

Setbacks

Required Front : _____ ft.
 Proposed Side : _____ ft.
 Rear : _____ ft.

Lot Coverage

Existing : _____ ft.
 Proposed : _____ ft.

Liveable Area

Existing : _____ ft.
 Proposed : _____ ft.

Proposed Garage: _____ ft. x _____ ft. **Total No. of Bedrooms**

No. of Spaces: _____ Existing: _____ Proposed: _____

What is the prevailing architectural style of your home?

Spanish Colonial Revival Neoclassic
 Mediterranean/Italian Renaissance Tudor
 Monterey Period Revival Ranch House
 Colonial Revival Minimal Traditional
 Other: _____

NEIGHBORHOOD COMPATIBILITY

1. What is the prevailing architectural style of your neighborhood?

Spanish Colonial Revival Neoclassic
 Mediterranean/Italian Renaissance Tudor
 Monterey Period Revival Ranch House
 Colonial Revival Minimal Traditional
 Other: _____

2. Is the pattern of homes in the neighborhood predominantly single-story or two-story?

Two houses on the right **Single Story** **Two Story**
 Two house on the left
 Three houses to the rear
 Three houses directly across street

3. Is there a prevailing distance from the curb to the front of the house in your neighborhood?

Prevailing setback to front of house (estimated) _____ ft.
 Average setback to front of house (estimated) _____ ft.
 Proposed front setback _____ ft.

RESIDENTIAL DESIGN GUIDELINES

APPENDIX D: Building Project Checklist cont'd (pg.2)

ADDITIONS, REMODELS & NEW HOMES: SPECIAL DESIGN CONSIDERATIONS																									
<p>1. Additions should harmonize with the existing structure by matching the existing architectural style, material, roof slope, window type, etc.</p> <table style="width: 100%; border-collapse: collapse;"> <thead> <tr> <th style="width: 50%;"></th> <th style="width: 25%; text-align: center;"><i>Existing</i></th> <th style="width: 25%; text-align: center;"><i>Proposed</i></th> </tr> </thead> <tbody> <tr> <td>Architectural Style</td> <td>_____</td> <td>_____</td> </tr> <tr> <td>Roof type</td> <td>_____</td> <td>_____</td> </tr> <tr> <td>Roof Pitch</td> <td>_____</td> <td>_____</td> </tr> <tr> <td>Roof Material</td> <td>_____</td> <td>_____</td> </tr> <tr> <td>Exterior walls</td> <td>_____</td> <td>_____</td> </tr> <tr> <td>Window type</td> <td>_____</td> <td>_____</td> </tr> <tr> <td>Other features</td> <td>_____</td> <td>_____</td> </tr> </tbody> </table>		<i>Existing</i>	<i>Proposed</i>	Architectural Style	_____	_____	Roof type	_____	_____	Roof Pitch	_____	_____	Roof Material	_____	_____	Exterior walls	_____	_____	Window type	_____	_____	Other features	_____	_____	
	<i>Existing</i>	<i>Proposed</i>																							
Architectural Style	_____	_____																							
Roof type	_____	_____																							
Roof Pitch	_____	_____																							
Roof Material	_____	_____																							
Exterior walls	_____	_____																							
Window type	_____	_____																							
Other features	_____	_____																							
<p>2. If you are changing the architectural style of your house, identify the new style you are using and the concept behind using it:</p> <p>_____</p> <p>_____</p> <p>_____</p> <p>_____</p> <p>_____</p>																									
<p>3. Is the new style chosen for the remodel or new home compatible with the existing character of your neighborhood? Explain.</p> <p>_____</p> <p>_____</p> <p>_____</p> <p>_____</p>																									

SITE DEVELOPMENT	
<p>1. How well does your design reflect the natural topography and attributes of the site?</p> <p><input type="checkbox"/> Is the site flat?</p> <p><input type="checkbox"/> Are there slopes anywhere on the site?</p> <p><input type="checkbox"/> Are neighboring properties at the same grade or level as the site?</p> <p><input type="checkbox"/> Other: _____</p> <p>_____</p> <p>_____</p> <p>_____</p> <p>_____</p>	
<p>2. Are there any established trees on your property that will need to be considered in your project design and construction?</p> <p><input type="checkbox"/> Type of tree _____</p> <p><input type="checkbox"/> Height _____ feet</p> <p><input type="checkbox"/> Trunk diameter _____ inches</p> <p><input type="checkbox"/> Distance from proposed structure _____ feet</p> <p><input type="checkbox"/> Distance from any proposed chimneys _____ feet</p> <p><input type="checkbox"/> Distance from any proposed fence or wall _____ feet</p> <p>Notes: _____</p> <p>_____</p> <p>_____</p> <p>_____</p> <p>_____</p>	

RESIDENTIAL DESIGN GUIDELINES



APPENDIX D: Building Project Checklist cont'd (pg.3)

GOOD NEIGHBOR CONSIDERATIONS

1. Will your proposed structure significantly affect your neighbor's access to sunlight for adjacent gardens, patios and rooms?

	<i>Garden</i>	<i>Patio</i>	<i>Interior Rooms</i>
House on the right	<input type="checkbox"/>	<input type="checkbox"/>	<input type="checkbox"/>
House on the left	<input type="checkbox"/>	<input type="checkbox"/>	<input type="checkbox"/>
House to the rear	<input type="checkbox"/>	<input type="checkbox"/>	<input type="checkbox"/>

Notes: _____

2. How will you mitigate any negative impacts?

Situating the structure on the lot to minimize impacts
 Locating taller sections of the building where they will have the least impact
 Other: _____

3. Will your proposed structure significantly affect your neighbor's privacy?

	<i>Windows</i>	<i>Balconies</i>
House on the right	<input type="checkbox"/>	<input type="checkbox"/>
House on the left	<input type="checkbox"/>	<input type="checkbox"/>
House to the rear	<input type="checkbox"/>	<input type="checkbox"/>

Windows: How will you mitigate that impact?
 Offsetting or staggering window locations from neighbor's window
 Situating windows high enough to reduce or eliminate impact
 Using obscure glass
 Landscaping
 Other: _____

Balconies: How will you mitigate that impact?
 Designing a balcony that will eliminate any impact
 Locating the balcony where it will have no impact
 Landscaping
 Other: _____

4. How will you minimize the impact of any proposed outdoor lighting on your neighbors?

Locating or directing lighting so that no direct light extends onto neighboring properties
 Shielding fixtures so that no direct light extends onto neighboring properties
 Other: _____

