



SEDIMENTATION MANUAL

2nd Edition



Los Angeles County Department of Public Works
March 2006

Los Angeles County Department of Public Works

SEDIMENTATION MANUAL **2nd Edition**



Water Resources Division
March 2006

Donald L. Wolfe, Director

900 South Fremont Avenue
Alhambra, California 91803



SEDIMENTATION MANUAL

2nd Edition

1st Edition Prepared By:

Mahdad Derakhshani

Issac Gindi

Glenn Howe

Hartun Khachikian

Belinda Kwan

Allen Ma

Martin Moreno

Mariette Schleikorn

Loreto Soriano

William Ward

1st Edition Reviewed By:

Eric Bredehorst

Alan Bentley

Chandler Garg

Sree Kumar

Iraj Nasserri

David Potter

2nd Edition Formatted and Reviewed By:

Iraj Nasserri

Sterling Klippel

Ben Willardson

Loreto Soriano

Janelle Moyer

Mariné Gaplandzhyan

TABLE OF CONTENTS

CHAPTER 1

Introduction	1
1.1 Acknowledgement	1
1.2 Purpose and Scope	1
1.3 Factors Affecting Sediment Production	2
1.4 Factors Affecting Sediment Transport	3

CHAPTER 2

Public Works' Policy on Levels of Flood Protection	6
2.1 Policy for Sediment in Flow	6
2.2 Santa Clara River & Major Tributaries – Drainage Policy	8

CHAPTER 3

Sediment Production and Delivery	13
3.1 Introduction	13
3.2 Sediment Production Zones and Curves	14
3.3 Sediment Delivery	15
3.4 Bulking and Burned Flow Hydrograph	21
3.5 General Form Equations – Debris Production Rates and Bulking Factors	25

CHAPTER 4

Sediment Control	29
4.1 Introduction	29
4.2 General Design Considerations	31
4.3 Standard Sediment Control Methods	34
4.4 Other Sediment Control Methods	43
4.5 Flood Retention/Detention Basin	48

CHAPTER 5

Sediment Transport	49
5.1 Introduction	49
5.2 Soft-Bottom Channels with Levees	51
5.3 Soft-Bottom Channels with Levees and Stabilizers	60
5.4 Hard-Bottom (Reinforced Concrete) Channels	63
5.5 Closed Drains	65
5.6 Inlet and Outlet Design	68
5.7 Floodproofing of Developments in Natural Watercourses	69

INDEX

LIST OF SYMBOLS

REFERENCES

APPENDIX A – Hydrologic Maps

**APPENDIX B – Debris Production Rate Curves
Peak Bulking Factor Curves**

APPENDIX C – Sedimentation Design Curves

APPENDIX D – Sedimentation Examples

**APPENDIX E – Comparison of Design Criteria
for Debris Basins, Elevated Inlets,
and Desilting Inlets**

**APPENDIX F – Requirements for Design of Closed
Conduits Carrying Bulked Flow**

Introduction

1.1 ACKNOWLEDGEMENT

The first edition of the Sedimentation Manual (1993) has been reformatted to be consistent with the 2006 Hydrology Manual. The methods from the Sedimentation Manual have not changed. This second edition of the Sedimentation Manual contains updated references to the 2006 Hydrology Manual and does not share appendices.

A group consisting of Isaac Gindi, Mariette Schleikorn, William Ward, Belinda Kwan, Loreto Soriano, Glenn Howe, Mahdad Derakhshani, Hartun Khachikian, Martin Moreno, and Allen Ma prepared the first edition of this manual under the principal direction of Sree Kumar and David Potter. An overview committee comprised of Eric Bredehorst, Alan Bentley, Chander Garg, Sree Kumar, Iraj Nasser, and David Potter reviewed the contents of the Manual. Mr. Garvin Pederson, Mr. Reza Izadi, and Mr. Michael Anderson supervised the entire project. Laurel Putnam, Mooler Ang, Michael Miranda, Sanjay Thakkar, Phat Ho, and Darrell Yip also provided assistance.

1.2 PURPOSE AND SCOPE

This manual establishes the Los Angeles County Department of Public Works' sedimentation design criteria. The procedures and standards contained in this manual were developed mostly by the Hydraulic/Water Conservation Division of Los Angeles County Department of Public Works as the need arose to design erosion control structures, sediment retention structures, and channels carrying sediment laden flows. These sedimentation techniques are applicable in the design of local debris basins, storm drains, retention and detention basins, and channel projects within Los Angeles County.

Some sections of this Manual were previously part of Public Works' Hydrology Manual. When the Sedimentation Manual was developed, all information in the Hydrology Manual (March 1989 Edition) related to sedimentation was transferred into this manual. The hydraulic and structural design considerations are covered in Public Works' Hydraulic Design Manual (March 1982 Edition) and Public Works' Structural Design Manual (April 1982 Edition). For detailed debris basin design, refer to Public Works' Debris Dams and Basins Design Manual.

The Sedimentation Manual Appendices contain reference material, information, and design examples.

Public Works distributed copies of the first edition of the 1993 Sedimentation Manual and Appendix to members of the Land Development Advisory Committee (LDAC) for their review. The members who responded indicated that they had no comments on the Sedimentation Manual. This second edition reformats the manual and updates references to the 2006 Hydrology Manual.

1.3 FACTORS AFFECTING SEDIMENT PRODUCTION

Sediment production from a watershed is a function of several variables. The most evident variables in the County of Los Angeles are: vegetative cover, rainfall intensity, slopes of the watershed, geology, soil type, and size of drainage area. Figure 1.3.1 shows the result of sediment production after the 1969 storms.



Figure 1.3.1
Sediment Production:
Glencoe Heights, 1969

Fire greatly increases the amount of runoff and erosion from a mountain watershed. A recently denuded watershed will produce greater than normal sediment volumes due to higher runoff caused by a lack of vegetation and lowered infiltration rates. The inclusion of sediment in runoff results in a greater total discharge. This is referred to as bulking. Figure 1.3.2 shows a burned watershed below San Dimas Dam after the 2002 fires.



Figure 1.3.2

Burned Watershed Below
San Dimas Dam
After 2002 Fires

Flood flows from a denuded watershed can transport large quantities and sizes of sediment. Sediment production from a major storm has amounted to as much as 120,000 cubic yards per square mile of watershed. Boulders up to eight feet across have been deposited in valley areas a considerable distance from their source. Sediment discharge from a major storm can be equal to the actual storm runoff, that is, runoff bulked 100 percent.

1.4 FACTORS AFFECTING SEDIMENT TRANSPORT

Sediment transport depends on several factors such as particle size, shape, specific gravity, flow velocity, and depth. The ability of a stream to transport sediment increases as discharge increases and as streambed gradient increases. The three forms of sediment movement evident in the County of Los Angeles are discussed below.

General Sediment Transport

Sediment is transported as bed load or suspended load. Bed load is mostly transported by sliding, rolling, and bouncing over the bed. Suspended load is the portion of the load that is supported by turbulent eddies. Suspended load includes the finer portion of the bed material, which is only intermittently suspended within the flow. It also includes wash load, which consists of particles too fine to settle to the channel bed. Figure 1.4.1 shows high velocity flow, downstream of San Dimas Dam, which is capable of moving large amounts of sediment.



Figure 1.4.1
Flow Downstream of
San Dimas Dam

Mud Floods

A flood in which the water carries heavy loads of sediment, generally between 20 to 45 percent by volume, is referred to as a mud flood. Mud floods typically occur in watercourses or on alluvial fans discharging from mountainous regions, although they may occur on less mountainous flood plains as well. Conventional hydraulic analysis using momentum, energy, and continuity theories are applicable, provided appropriate parameters are used.

Mudflows

A mudflow is a specific subset of landslides where the flow has sufficient viscosity to support large boulders within a matrix of smaller-sized particles. Mudflows may be confined to drainage channels or may occur unconfined on hill-slopes and alluvial fans. The concentration of sediment is generally higher than mud floods (typically 45 to 60 percent by volume). Mudflows are generally treated as viscoplastic fluids. Analysis requires use of the non-Newtonian theory.

The hydromechanics of mud floods and mudflows are not covered in this manual. Figure 1.4.2 shows the aftermath of mudflow in Upper Shields Debris Basin.



Figure 1.4.2

Upper Shields Debris Basin
March 3, 1978

CHAPTER

2

Public Works' Policy on Levels of Flood Protection

2.1 POLICY FOR SEDIMENT IN FLOW

A Public Works memorandum that established the policy on levels of flood protection for hydrologic design is included in Chapter 4 of the 2006 Hydrology Manual. That policy provides instructions on which design storm or rainfall frequency to use in developing runoff rates. This section discusses the additional requirements if flow includes sediment.

Capital Flood Protection

The following facilities and structures must be designed for the Capital Flood. The Capital Flood is the burned and bulked (where applicable) runoff from a 50-year frequency design storm falling on a saturated watershed. For fire factors see Chapter 6 of the 2006 Hydrology Manual. Section 3.4 of this Manual contains information on flow bulking.

Natural Watercourses

The Capital Flood level of protection applies to all facilities, including open channels, closed conduits, bridges, and dams and debris basins, that are constructed to transport or intercept sediment laden floodwaters from natural watercourses. Dams that are under the State of California (D.S.O.D.) jurisdiction must also meet the Probable Maximum Flood criteria found in Section 4.4 and Section 5.5 of the 2006 Hydrology Manual.

A natural watercourse is typically a path along which water flows due to natural topographic features. Refer to Section 4.2 of the 2006 Hydrology Manual for more detail. Figure 2.1.1 shows a natural portion of the San Gabriel River, below Morris Dam.



Figure 2.1.1
San Gabriel River
Below Morris Dam

Sediment Retention Facilities

The Capital Flood level of protection applies to all retention basins and detention basins designed to intercept sediment-laden floodwaters. Sediment retention basins must be designed to handle the design sediment volume. Refer to Chapter 3 for information on sediment production and delivery and to Chapter 4 for details on sediment control facilities.

Culverts

The Capital Flood level of protection applies to all culverts that pass sediment-laden flood waters under public roads.

Facilities with Tributary Areas Subject to Sediment Production

For any facility, apply the Capital Flood to all undeveloped tributary areas that are likely to produce sediment, whether or not the areas are likely to burn.

2.2 SANTA CLARA RIVER & MAJOR TRIBUTARIES - DRAINAGE POLICY

The Santa Clara River Basin is the second largest of the eight moderately developed drainage basins in Southern California and a major source of sediment for the beaches along the coast. In addition, the groundwater basins that underlie the Santa Clara River are an important source of water for the valley. It is important that the groundwater basins continue to be recharged by streambed percolation.

Therefore, the following standards have been adopted by the Department of the Public Works to maintain, as closely as possible, the environmental balance that exists in the Santa Clara River Basin. Note these standards supersede all previous standards and reports written for the Santa Clara River Basin.

- 1) The design of flood protection facilities for the Santa Clara River shall be based on the following:
 - a) Public Works Capital Flood flow rates (50-year rainfall Q, burned and bulked only).
 - b) Soft bottom waterways with levees.
 - c) Protective levees and additional facilities such as drop structures or stabilizers as required, shall be designed using the Public Works criteria.
- 2) The design of flood protection facilities for major tributaries of the Santa Clara River that have been mapped by the Public Works as floodways (see Figures 2.2.1 and 2.2.2) or have a burned and bulked flow rate¹ of 2,000 cfs or greater as determined by Public Works' Capital Flood hydrology shall be based on items b) and c) above.
- 3) The design of flood protection facilities for tributary streams to the Santa Clara River that have existing flood control improvements shall be compatible with these existing facilities. See Table 2.2.1.

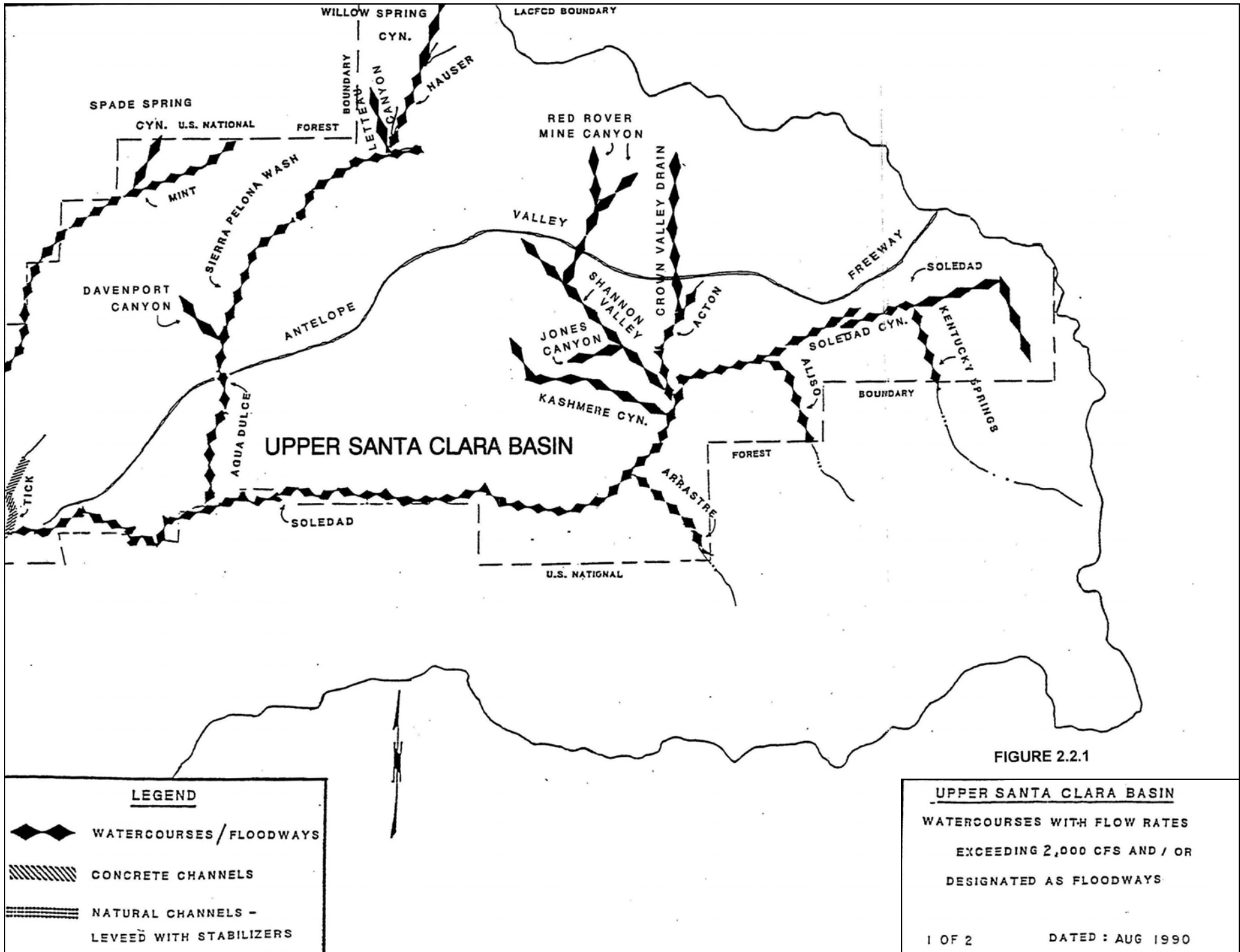

Figure 2.2.1

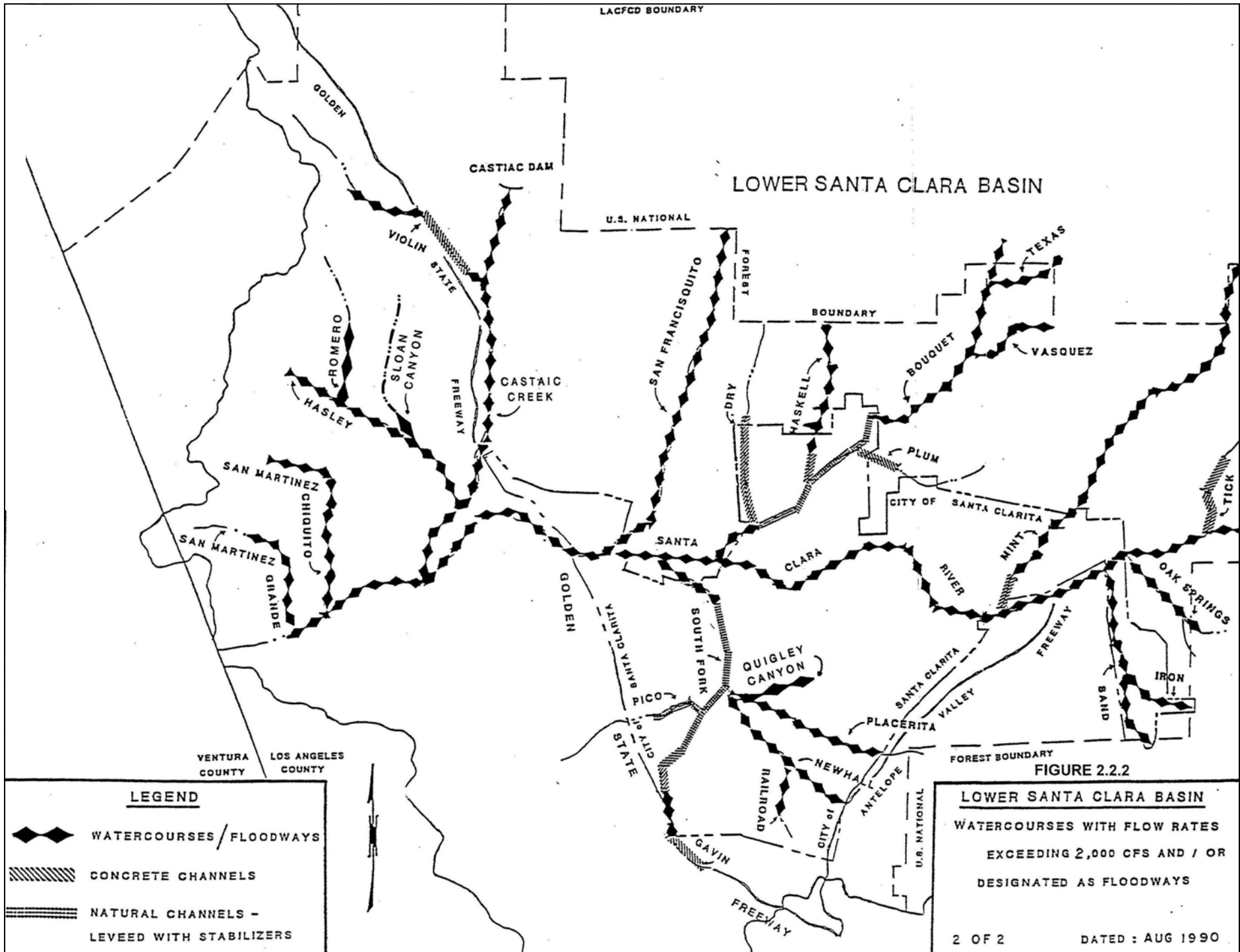

Figure 2.2.2

- 4) The soft bottom waterways shall be designed to maintain equilibrium between sediment supply to the waterway and sediment transport through the waterway. In cases where a soft bottom waterway is subject to significant deposition due to high sediment supply or significant erosion due to lack of sediment supply, then the drainage concept shall be discussed with the Public Works prior to submitting plans.

The following criteria was added in response to comments made by public on the previous policy:

- 1) Covered sections of natural bottom channels shall primarily be limited to street crossings.
- 2) Whether a bridge or a culvert is required for a road crossing over a soft-bottom channel depends on the flow rates and the magnitude of debris. Short culverts may be acceptable under certain cases, but in general, bridges shall be anticipated.

Figure 2.2.3 shows debris caught on a railroad bridge in the South Fork tributary of the Santa Clara River, which is a result of bulked flows.



Figure 2.2.3
Santa Clara River
South Fork

Main River / Tributary	Current Improvement	Compatible Future Channel Improvement
Santa Clara River	Soft bottom with protective levee	Soft bottom with stabilizers where necessary
Tick Canyon	Lower reach-concrete channel	Upper reach-concrete channel with debris control
Mint Canyon	Lower reach-concrete channel	Middle reach-concrete channel Upper reach-soft bottom with stabilizers
Bouquet Canyon	Middle reach-soft bottom with stabilizers	Lower and Upper reaches-soft bottom with stabilizers
Dry Canyon	Lower reach-concrete channel	Upper reach-concrete channel
Haskell Canyon	Lower reach-concrete channel	Upper reach-soft bottom with stabilizers
Plum Canyon	Lower reach-concrete channel	Upper reach-concrete channel with debris control or soft bottom with stabilizers
South Fork -Santa Clara	Lower reach-soft bottom with stabilizers Middle reach-concrete channel	Lower reach-soft bottom with stabilizers Upper reach-concrete channel with debris control.
Pico Canyon	Lower reach partly soft bottom with stabilizers partly concrete channel	Upper reach-soft bottom with stabilizers
San Francisquito	Lower reach-soft bottom with stabilizers	Upper reach-soft bottom with stabilizers
Violin Canyon	Lower reach-concrete channel	Upper reach-concrete channel with debris control.
Castaic Creek	Below I-5 Freeway-soft bottom with protective levee	Above I-5 Freeway-soft bottom with stabilizers or concrete channel.

Table 2.2.1

Drainage Facilities for the Santa Clara River and Major Tributaries

¹ Public Works' Capital Flood Flow Rates (50-year rainfall Q, burned and bulked)

Sediment Production and Delivery

3.1 INTRODUCTION

Los Angeles Basin, Santa Clara River Basin, and Antelope Valley are divided into zones that yield similar volumes of sediment under similar conditions. These Debris¹ Potential Area (DPA) zone delineations are found in Appendix A.

Sediment production from a watershed is a rate at which sediment passes a particular point, usually expressed as cubic yards / square mile / storm. The sediment production is dependent upon many factors such as: rainfall intensity, geology, soil type, vegetative coverage, runoff, and watershed slope. Figure 3.1.1 shows a house buried by debris produced in Glencoe Canyon.



Figure 3.1.1
Glencoe Canyon, Glendora

A Design Debris Event (DDE) is defined as the quantity of sediment produced by a saturated watershed significantly recovered from a burn (after four years) as a result of a 50-year, 24-hour rainfall amount. The concept of DPA zones and Debris Production (DP) curves for determining watershed sediment production was introduced after the 1938 storms. Each DP curve and DPA zone represents particular types of geologic, topographic, vegetative, and rainfall features. These curves have been modified several times since inception of the concept.

A rate of 120,000 cubic yards / square mile / storm has been established as the design debris event for a one square-mile drainage area in DPA 1 zone. This rate is used as a design value for debris basins in areas of high relief and granitic formations characterizing the San Gabriel Mountains and Verdugo Hills. Other mountain areas in the County have been assigned relatively lower sediment potentials based on historical data and differences in topography, geology, and rainfall. Studies of sediment flow records indicate that areas less than one square-mile are expected to produce a higher rate of sediment production and areas greater than one square mile a lower rate.

In designing sediment retention facilities, use the DP curves to determine sediment production. Section 3.3 contains debris production equations for undeveloped watersheds, partially developed watersheds, watersheds with multiple DPA zones, and partially controlled watersheds.

In cases where slides or unstable slopes are found in the watershed, additional capacity may be required in the sediment retention facility. The additional capacity must be determined by a registered geologist and approved by Public Works' Geotechnical and Materials Engineering Division.

3.2 SEDIMENT PRODUCTION ZONES AND CURVES

The Los Angeles Basin has five sediment production curves, the Santa Clara River Basin has four curves, and the Antelope Valley has eight. See the debris production curves in Appendix B.

The use of DPA 7 in the Los Angeles Basin is limited to undeveloped areas with slopes less than 20%.

3.3 SEDIMENT DELIVERY

The following sections show the procedures to determine sediment production from watersheds with different characteristics. Sediment production is used for the selection and sizing of sediment control/conveyance structures. See Example 1 in Appendix D.

Undeveloped Watershed

Use the following procedure to determine sediment production at the outlet of an undeveloped watershed that completely falls within the boundaries of one DPA zone:

- 1) Identify the DPA zone from the maps in Appendix A.
- 2) Determine the drainage area (A) in square miles.
- 3) Determine the Debris Production Rate (DPR) from curves in Appendix B-1, 2, or 3, corresponding to the DPA zone and the drainage area found in steps 1 and 2 above. For areas smaller than 0.1 square mile, use the same DPR for 0.1 square mile.
- 4) Calculate the total Debris Production by multiplying the Debris Production Rate, from step 3, by the drainage area, from step 2. Equation 3.3.1 is used for single undeveloped watersheds within a single DPA Zone.

For a single watershed use Equation 3.3.1:

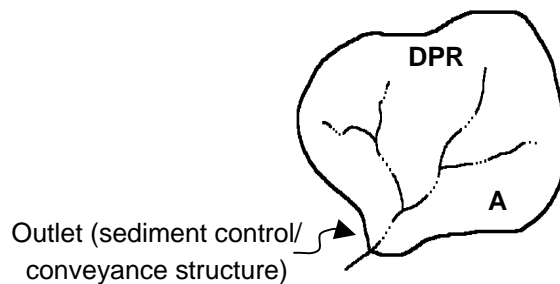

Figure 3.3.1

Debris Production for a Single Watershed

$$DP = DPR_{(A)} \times A$$

Equation 3.3.1

Where: DP = Debris Production in yd³
DPR = Debris Production Rate in yd³/mi²

For multiple watersheds having a common outlet use Equation 3.3.2:

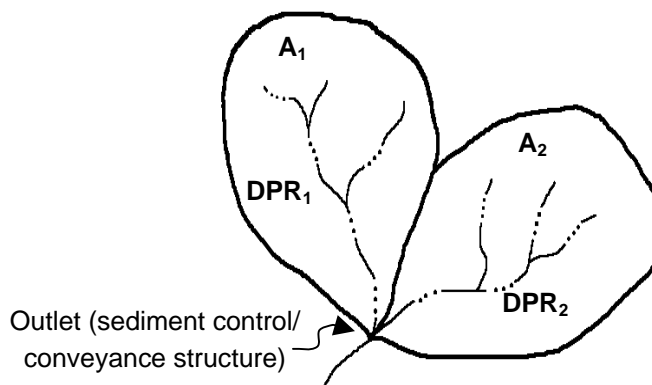

Figure 3.3.2

Debris Production for Multiple Watersheds

$$DP = (DPR_{1(A_1)} \times A_1) + (DPR_{2(A_2)} \times A_2)$$

Equation 3.3.2

Where:

- DP = Debris production in yd³
- DPR_{i(A_i)} = Debris production rate based on area A_i in DPA zone i in yd³/mi²
- A_i = Drainage area in mi²

Partially Developed Watershed

Developed areas such as house/commercial pads, paved streets and parking areas, and maintained permanently landscaped areas that are not subject to burning (e.g. golf courses, cemeteries, parks) are considered non-debris producing. Other features such as a geologically non-erosive rock may be considered non-debris producing if supported by a geologic report. Use Equation 3.3.3 to calculate the total sediment production.

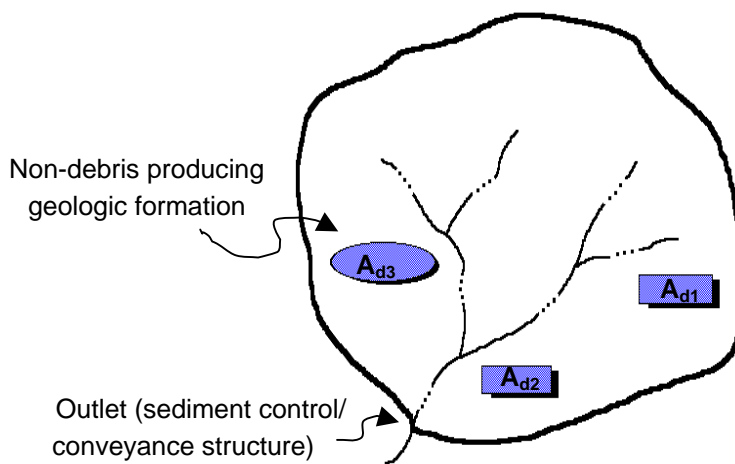

Figure 3.3.3

Debris Production for a Partially Developed Watershed

$$DP = DPR_{(A)} \times A_u \left(\frac{A_u}{A} \right) + DPR_{(A_u)} \times A_u \left(\frac{A_d}{A} \right)$$

$$A_d = A_{d1} + A_{d2} + A_{d3}$$

$$A_u = A - A_d$$

Equation 3.3.3

Where:

- DP = Debris production in yd^3
- $DPR_{(A)}$ = Debris production rate based on the total drainage area A in yd^3/mi^2
- $DPR_{(A_u)}$ = Debris production rate based on the total undeveloped drainage area A_u in yd^3/mi^2
- A = Total drainage area including developments in mi^2
- A_u = Total undeveloped area in mi^2
- A_d = Total developed area (existing only) in mi^2

Watersheds with Multiple Debris Production Zones

For an undeveloped watershed in two DPA zones use Equation 3.3.4.

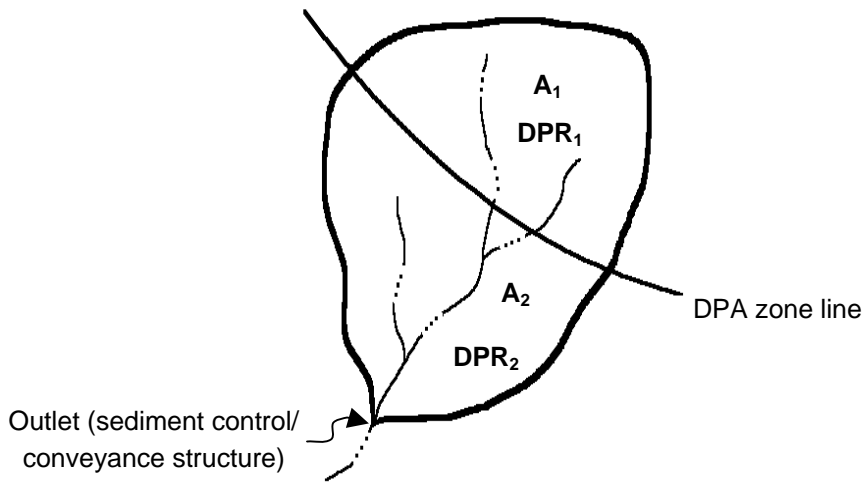

Figure 3.3.4

Debris Production for an Undeveloped Watershed in Two DPA zones

$$DP = DPR_{1(A_1+A_2)} \times A_1 \left(\frac{A_1}{A_1 + A_2} \right) + DPR_{1(A_1)} \times A_1 \left(\frac{A_2}{A_1 + A_2} \right) +$$

$$DPR_{2(A_1+A_2)} \times A_2 \left(\frac{A_2}{A_1 + A_2} \right) + DPR_{2(A_2)} \times A_2 \left(\frac{A_1}{A_1 + A_2} \right)$$

Equation 3.3.4

Where: DP = Debris production in yd³
 DPR_{i(A_i)} = Debris production rate for drainage area A_i in DPA zone i in yd³/mi²
 A_i = Drainage area in mi²

For a partially developed watershed in two DPA zones use Equation 3.3.5.

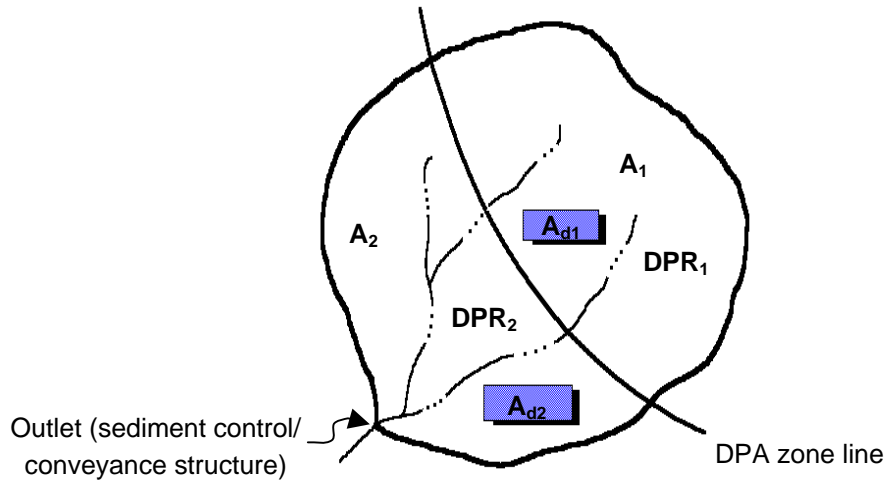

Figure 3.3.5

Debris Production for an Undeveloped Watershed in two DPA zones

$$DP = DPR_{1(A_1+A_2)} (A_1 - A_{d1}) \left(\frac{A_1 - A_{d1}}{A_1 + A_2} \right) + DPR_{1(A_1-A_{d1})} (A_1 - A_{d1}) \left(\frac{A_2 + A_{d1}}{A_1 + A_2} \right) +$$

$$DPR_{2(A_1+A_2)} (A_2 - A_{d2}) \left(\frac{A_2 - A_{d2}}{A_1 + A_2} \right) + DPR_{2(A_2-A_{d2})} (A_2 - A_{d2}) \left(\frac{A_1 + A_{d2}}{A_1 + A_2} \right)$$

Equation 3.3.5

Where: DP = Debris production in yd³
 DPR_{i(A_i)} = Debris production rate for drainage area A_i in DPA zone i in yd³/mi²
 A_i = Drainage area including development in mi²
 A_{di} = Developed area in area A_i in mi²

Watersheds with Existing Sediment Control Structure

Use the following procedure to determine sediment production from a watershed partially controlled by an existing sediment control structure that meets the Public Works standards:

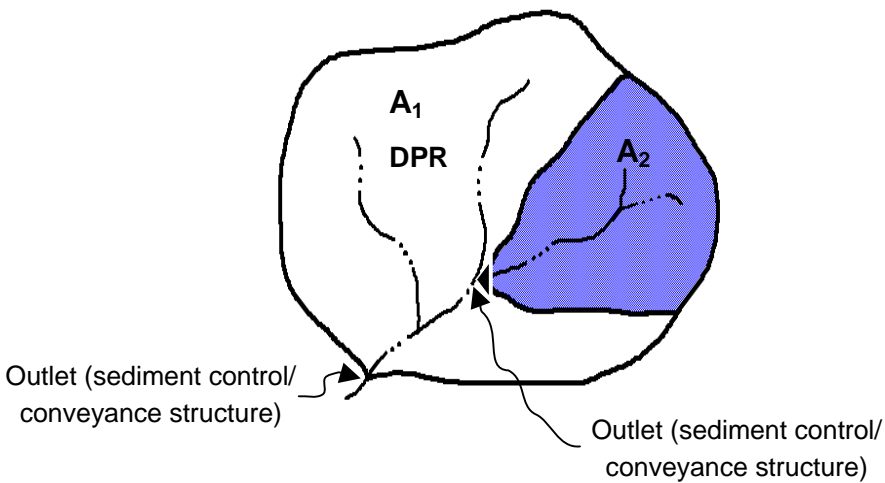

Figure 3.3.6

Debris Production for a Watershed with a Sediment Control Structure.

Follow steps (1) through (3) in the “Undeveloped Watershed” portion of Section 3.3. The equation to calculate the total sediment production depends on the condition of the existing sediment control structure.

(a.) Adequately sized:

$$DP = DPR_{(A_1+A_2)} A_1 \left(\frac{A_1}{A_1 + A_2} \right) + DPR_{A_1} A_1 \left(\frac{A_2}{A_1 + A_2} \right)$$

Equation 3.3.6

(b.) Undersized:

$$DP = DPR_{(A_1+A_2)} A_1 \left(\frac{A_1}{A_1 + A_2} \right) + DPR_{A_1} A_1 \left(\frac{A_2}{A_1 + A_2} \right) + DPR_{A_2} A_2 - C$$

Equation 3.3.7

Where: DP = Debris production in yd³
 DPR_(A_i) = Debris production rate based on area A_i in yd³/mi²
 A_i = Drainage area in mi²
 C = Capacity of sediment control structure in yd³

3.4 BULKING AND BULKED FLOW HYDROGRAPH

Bulking

Bulking is the increase in flow rate due to inclusion of sediment in the flow. This condition applies primarily to mountain areas subject to wildfires that destroy the vegetative cover protecting the soil. It also applies to watersheds in mountain areas with loose surface material that is likely to produce sediment. Figure 3.4.1 is an example of a burned watershed near Placerita Canyon Road. This watershed will potentially produce a bulked flow rate during a storm.



Figure 3.4.1

Placerita Canyon Road
after the Foothill Fire
October 10, 2004

The peak bulking factor curves in Appendix B show the proportion of the bulked flow rate to burned flow rate during the peak of the flood hydrograph or to the clear flow rate if the watershed has no potential to burn. These curves are used to design channels in a sediment producing area where a

debris basin does not exist. Example 1 in Appendix D illustrates use of these curves.

The procedures for determining bulking factors for watersheds with different characteristics are similar to the procedures for determining sediment production explained in Section 3.3. To determine bulked flow rates, Q_B , use the equation listed below for the appropriate case.

For single undeveloped watersheds (see Figure 3.3.1):

$$Q_B = BF_{(A)} \times Q_{(A)} \quad \text{Equation 3.4.1}$$

For multiple undeveloped watersheds having a common outlet (see Figure 3.3.2):

$$Q_B = BF_{1(A_1)} \times \left(\frac{Q_{(A_1)} A_1}{A_1 + A_2} \right) + BF_{2(A_2)} \times \left(\frac{Q_{(A_2)} A_2}{A_1 + A_2} \right) \quad \text{Equation 3.4.2}$$

For partially developed watersheds (see Figure 3.3.3):

$$Q_B = BF_{(A)} \times \left(\frac{Q_{(A)} A_u}{A} \right) \left(\frac{A_u}{A} \right) + BF_{(A_u)} \times \left(\frac{Q_{(A)} A_u}{A} \right) \left(\frac{A_d}{A} \right) + \left(\frac{Q_{(A)} A_d}{A} \right) \quad \text{Equation 3.4.3}$$

For a watershed with multiple debris production zones (see Figure 3.3.4):

$$Q_B = BF_{1(A_1+A_2)} \times \left(\frac{Q_{(A_1)} A_1}{A_1 + A_2} \right) \left(\frac{A_1}{A_1 + A_2} \right) + BF_{1(A_1)} \times \left(\frac{Q_{(A_1)} A_1}{A_1 + A_2} \right) \left(\frac{A_2}{A_1 + A_2} \right) + BF_{2(A_1+A_2)} \times \left(\frac{Q_{(A_2)} A_2}{A_1 + A_2} \right) \left(\frac{A_2}{A_1 + A_2} \right) + BF_{2(A_2)} \times \left(\frac{Q_{(A_2)} A_2}{A_1 + A_2} \right) \left(\frac{A_1}{A_1 + A_2} \right) \quad \text{Equation 3.4.4}$$

$$Q = Q_{A_1+A_2}$$

Where:

- Q = Clear or burned discharge in cfs
- Q_B = Bulked or burned and bulked discharge in cfs
- $BF_{i(A_i)}$ = Bulking factor based on area A_i
- A_i = Drainage area in mi^2
- A_u = Total undeveloped area in mi^2
- A_d = Total developed area in mi^2

For a partially developed watershed in multiple DPA zones (see Figure 3.3.5):

$$\begin{aligned}
 Q_B = & BF_{1(A_1+A_2)} \left(\frac{Q (A_1 - A_{d1})}{A_1 + A_2} \right) \left(\frac{A_1 - A_{d1}}{A_1 + A_2} \right) + \\
 & BF_{1(A_1 - A_{d1})} \left(\frac{Q (A_1 - A_{d1})}{A_1 + A_2} \right) \left(\frac{A_2 + A_{d1}}{A_1 + A_2} \right) + \left(\frac{Q (A_{d1})}{A_1 + A_2} \right) + \\
 & BF_{2(A_1+A_2)} \left(\frac{Q (A_2 - A_{d2})}{A_1 + A_2} \right) \left(\frac{A_2 - A_{d2}}{A_1 + A_2} \right) + \\
 & BF_{2(A_2 - A_{d2})} \left(\frac{Q (A_2 - A_{d2})}{A_1 + A_2} \right) \left(\frac{A_1 + A_{d2}}{A_1 + A_2} \right) + \left(\frac{Q (A_{d2})}{A_1 + A_2} \right)
 \end{aligned}$$

Equation 3.4.5

For a watershed with an adequately sized, existing control structure (see Figure 3.3.6):

$$Q_B = BF_{(A_1+A_2)} \left(\frac{Q A_1}{A_1 + A_2} \right) \left(\frac{A_1}{A_1 + A_2} \right) + BF_{(A_1)} \left(\frac{Q A_1}{A_1 + A_2} \right) \left(\frac{A_2}{A_1 + A_2} \right)$$

Equation 3.4.6

For a watershed with an undersized, existing control structure (see Figure 3.3.7):

$$\begin{aligned}
 Q_B = & BF_{(A_1+A_2)} \left(\frac{Q A_1}{A_1 + A_2} \right) \left(\frac{A_1}{A_1 + A_2} \right) + BF_{(A_1)} \left(\frac{Q A_1}{A_1 + A_2} \right) \left(\frac{A_2}{A_1 + A_2} \right) + \\
 & BF_{(A_2)} \times \left(\frac{Q A_2}{A_1 + A_2} \right)
 \end{aligned}$$

Equation 3.4.7

Where:

- Q = Clear or burned discharge in cfs
- Q_B = Bulked or burned and bulked discharge in cfs
- BF_(A_i) = Bulking factor based on area A_i
- A_i = Drainage area in mi²
- A_u = Total undeveloped area in mi²
- A_d = Total developed area in mi²

Appendix B has the bulking factor curves for the Los Angeles Basin, the Santa Clara River Basin, and the Antelope Valley area.

Bulked Flow Hydrograph (Sediment Transport Studies Only)

The bulked flow hydrograph is used for fluvial analysis and flood regulation studies. The bulked flow discharge can be obtained from the following equation:

$$Q_b = Q_s + Q_w \quad \text{Equation 3.4.8}$$

Where: Q_b = Bulked flow discharge
 Q_s = Sediment discharge
 Q_w = Water discharge (clear or burned).

This equation assumes that the peak of the sediment hydrograph coincides with the peak of the clear or burned water hydrograph.

To distribute the total design sediment volume (as described in Section 3.3) throughout a hydrograph, Public Works uses the following equation:

$$Q_s = a \times (Q_w)^n \quad \text{Equation 3.4.9}$$

Where: a = Bulking constant (fixed throughout the hydrograph)
 n = Bulking exponent (fixed throughout the hydrograph)

Assume values of n to solve for a . The total sediment volume determined from the computed sediment hydrograph is then compared with the total volume obtained from the sediment production curves in Appendix B-1, 2, or 3. The value of n is then adjusted until the total volume under the sediment hydrograph is approximately equal to the total volume obtained from Appendix B-1, 2, or 3.

Consult with Public Works for additional guidelines if analysis of this type is needed.

3.5 GENERAL FORM EQUATIONS – DEBRIS PRODUCTION RATES & BULKING FACTORS

These equations are the general form of the equations in Sections 3.3 and 3.4 and can be used for multiple DPA zones. The number to the right of each equation corresponds to the number of the equation in Section 3.3 or 3.4. The postscript “g” shows that this is the general form of the equation.

$$DP = DPR_{(A)} \times A \quad \text{Equation 3.3.1g}$$

$$DP = \sum (DPR_{i(A_i)} \times A_i) \quad \text{Equation 3.3.2g}$$

Where: DP = Debris production, in yd³
 DPR_{i(A_i)} = Debris production rate based on area A_i in DPA zone i
 in yd³/mi²
 A_i = Drainage area in mi²

$$DP = DPR_{(A)} \times A_u \left(\frac{A_u}{A} \right) + DPR_{(A_u)} \times A_u \left(\frac{A_d}{A} \right) \quad \text{Equation 3.3.3g}$$

$$A_d = \sum (A_{d_1} + A_{d_2} + A_{d_3} + \dots + A_{d_n})$$

$$A_u = A - A_d$$

Where: DP = Debris production in yd³
 DPR_(A) = Debris production rate based on the total drainage area,
 A, in yd³/mi²
 DPR_(A_u) = Debris production rate based on the total undeveloped
 drainage area, A_u, in yd³/mi²
 A = Total drainage area including developments in mi²
 A_u = Total undeveloped area in mi²
 A_d = Total developed area (existing only) in mi²

$$DP = \sum \left[DPR_{i(A)} \times A_i \left(\frac{A_i}{A} \right) + DPR_{i(A_i)} \times A_i \left(\frac{A - A_i}{A} \right) \right] \quad \text{Equation 3.3.4g}$$

$$DP = \sum \left[DPR_{i(A)} (A_i - A_{di}) \left(\frac{A_i - A_{di}}{A} \right) + \right. \\ \left. DPR_{i(A_i - A_{di})} (A_i - A_{di}) \left(\frac{(A - A_i) + A_{di}}{A} \right) \right] \quad \text{Equation 3.3.5g}$$

Where: DP = Debris production in yd³
 DPR_{i(A)} = Debris production rate for drainage area A_i in DPA zone i in yd³/mi²
 A = Total drainage area in mi²
 A_i = Drainage area including development in mi²
 A_{di} = Developed area in area A_i in mi²

$$DP = \sum \left[DPR_{i(A)} (A_i - A_{ci}) \left(\frac{A_i - A_{ci}}{A} \right) + \right. \\ \left. DPR_{i(A_i - A_{ci})} (A_i - A_{ci}) \left(\frac{(A - A_i) + A_{ci}}{A} \right) \right] \quad \text{Equation 3.3.6g}$$

$$DP = \sum \left[DPR_{i(A)} (A_i - A_{ci}) \left(\frac{A_i - A_{ci}}{A} \right) + \right. \\ \left. DPR_{i(A_i - A_{ci})} (A_i - A_{ci}) \left(\frac{(A - A_i) + A_{ci}}{A} \right) + DPR_{(A_{ci})} (A_{ci}) - C_i \right] \quad \text{Equation 3.3.7g}$$

Where: DP = Debris production in yd³
 DPR_(A_i) = Debris production rate based on area A_i, in yd³/mi²
 A = Total drainage area in mi²
 A_i = Drainage area in mi²
 A_{ci} = Controlled drainage area within A_i in mi²
 C_i = Capacity of sediment control structure in yd³

$$Q_B = BF_{(A)} \times Q \quad \text{Equation 3.4.1g}$$

$$Q_B = \sum \left[BF_{i(A_i)} \times \left(\frac{Q}{A} A_i \right) \right] \quad \text{Equation 3.4.2g}$$

$$Q_B = BF_{(A_u)} \times \left(\frac{Q}{A} A_u \right) \left(\frac{A_u}{A} \right) + BF_{(A_d)} \times \left(\frac{Q}{A} A_d \right) \left(\frac{A_d}{A} \right) + \left(\frac{Q}{A} A_d \right) \quad \text{Equation 3.4.3g}$$

$$Q_B = \sum \left[BF_{i(A)} \times \left(\frac{Q}{A} A_i \right) \left(\frac{A_i}{A} \right) + BF_{i(A_i)} \times \left(\frac{Q}{A} A_i \right) \left(\frac{(A - A_i)}{A} \right) \right] \quad \text{Equation 3.4.4g}$$

$$Q_B = \sum \left[BF_{i(A)} \left(\frac{Q (A_i - A_{d_i})}{A} \right) \left(\frac{A_i - A_{d_i}}{A} \right) + \right. \quad \text{Equation 3.4.5g}$$

$$\left. BF_{i(A_i - A_{d_i})} \left(\frac{Q (A_i - A_{d_i})}{A} \right) \left(\frac{(A - A_i) + A_{d_i}}{A} \right) + \left(\frac{Q (A_{d_i})}{A} \right) \right]$$

$$Q_B = \sum \left[BF_{i(A)} \left(\frac{Q (A_i - A_{c_i})}{A} \right) \left(\frac{A_i - A_{c_i}}{A} \right) + \right. \quad \text{Equation 3.4.6g}$$

$$\left. BF_{i(A_i - A_{c_i})} \left(\frac{Q (A_i - A_{c_i})}{A} \right) \left(\frac{(A - A_i) + A_{c_i}}{A} \right) + \left(\frac{Q (A_{c_i})}{A} \right) \right]$$

Where:

- Q = Total clear or burned discharge in cfs
- Q_B = Bulked or burned and bulked discharge in cfs
- BF_(A_i) = Bulking factor based on area A_i
- A = Total drainage area in mi²
- A_i = Drainage area in mi²
- A_u = Total undeveloped area in mi²
- A_d = Total developed area in mi²
- A_{ci} = Controlled drainage area within A_i in mi²

$$Q_B = \sum \left[BF_{i(A)} \left(\frac{Q (A_i - A_{ci})}{A} \right) \left(\frac{A_i - A_{ci}}{A} \right) + \right. \\ \left. BF_{i(A_i - A_{ci})} \left(\frac{Q (A_i - A_{ci})}{A} \right) \left(\frac{(A - A_i) + A_{ci}}{A} \right) + \left(\frac{Q (A_{ci})}{A} \right) + \right. \\ \left. BF_{(A_{ci})} \left(\frac{Q (A_{ci})}{A} \right) \right] \quad \text{Equation 3.4.7g}$$

Where:

- Q = Total clear or burned discharge in cfs
- Q_B = Bulked or burned and bulked discharge in cfs
- BF_(A_i) = Bulking factor based on area A_i
- A = Total drainage area in mi²
- A_i = Drainage area in mi²
- A_u = Total undeveloped area in mi²
- A_d = Total developed area in mi²
- A_{ci} = Controlled drainage area within A_i in mi²

Figure 3.5.1 shows sediment deposition at the confluence of Whitney and Elsmere Canyons at San Fernando Road on October 20, 2004.



Figure 3.5.1
Sediment Deposition -
Confluence of Whitney
and Elsmere Canyons at
San Fernando Road
October 20, 2004

¹ The term "debris" is used in this manual to be consistent with past practice but it means sediment.

Sediment Control

4.1 INTRODUCTION

This chapter discusses the type of structure acceptable to Public Works for sediment control, which depends on the volume of sediment to be delivered to the site. This, in turn, depends on the Debris Potential Area (DPA) zone for the particular watershed. Table 4.1.1 is used to determine the type of structure. See Chapter 3 for methods of computing the sediment production volume. Where sediment production is less than 250 cubic yards, sediment control is generally not needed. Design the conveying storm drain following the closed conduit bulked flow design criteria listed in Section 5.5. As stated in the State Water Code, Division 3, Section 6000-6452, certain dams are under State jurisdiction. The State may have additional requirements for the design of the facility. Figure 4.1.1 shows Englewild Debris Basin during cleanout.



Figure 4.1.1
Englewild Debris Basin
Post-Storm Cleanout
February 2003

Total Sediment Production (cubic yards)	Type of Structure	
	DPA zone 1-4 requirement	DPA zone 5-11 requirement
20,000 or greater	Debris Basin	Debris Basin
5,000 to 19,999	Debris Basin	Elevated Inlet
1,000 to 4,999	Debris Basin or Elevated Inlet *	Desilting Inlet
250 to 999	Desilting Inlet *	Inlet with bulked flow drain
less than 250	Inlet* with bulked flow drain	Inlet with bulked flow drain

Table 4.1.1Debris Control Structures
Based on Debris Production

* The use of elevated or desilting inlets and bulked flow drains in DPA zones 1 through 4 will only be approved by Public Works in special circumstances. The steepness of the watershed, presence of boulders, and higher sediment and mudflow potential in these DPA zones results in a greater risk of plugging the storm drain and damaging the desilting wall.

Figure 4.1.2 shows the Upper Shields Debris Basin used for sediment control.

**Figure 4.1.2**Upper Shields Debris Basin
March 3, 1978

4.2 GENERAL DESIGN CONSIDERATIONS

Location and Alignment

Locate all sediment retaining facilities in the existing watercourse. Align dams perpendicular to the original flow paths as shown in Figure 4.2.1. In order to insure maximum capacity, place the longer dimension of the basin along the flow line of the watercourse. If this distance is short in relation to the width, the intended capacity may not be attained.

Cone Slope

Sediment-laden flood flow, when reaching a sediment retaining facility, deposits the sediment up to spillway elevation and forms a delta or cone sloping upward from the spillway. For design purposes, this cone may contain up to, but no more than, one-half the capacity of the basin; this is called cone capacity. Figure 4.2.1 shows the cone capacity. The slope of the cone (S_D) is taken as one half of the average natural slope of the stream (S_N). The cone slope (S_D) should not exceed five percent (0.05).

In cases where the stream branches as it moves upstream from the debris dam, cone calculations are to be made along the individual profile lines of each branch. Depending upon the stream configuration, the profiles may branch from either the spillway crest or perhaps upstream of the crest. Hence, it is possible to have two different cone slopes. In these cases, the cone lines drawn perpendicular to the profile lines will intersect showing the configuration of the final cone surface as shown in Figure 4.2.2.

Level Capacity

The basin capacity up to the spillway elevation is called the "Level Capacity." Level capacity shall be at least one-half the capacity of the basin. Figure 4.2.1 shows the level capacity and cone capacity.

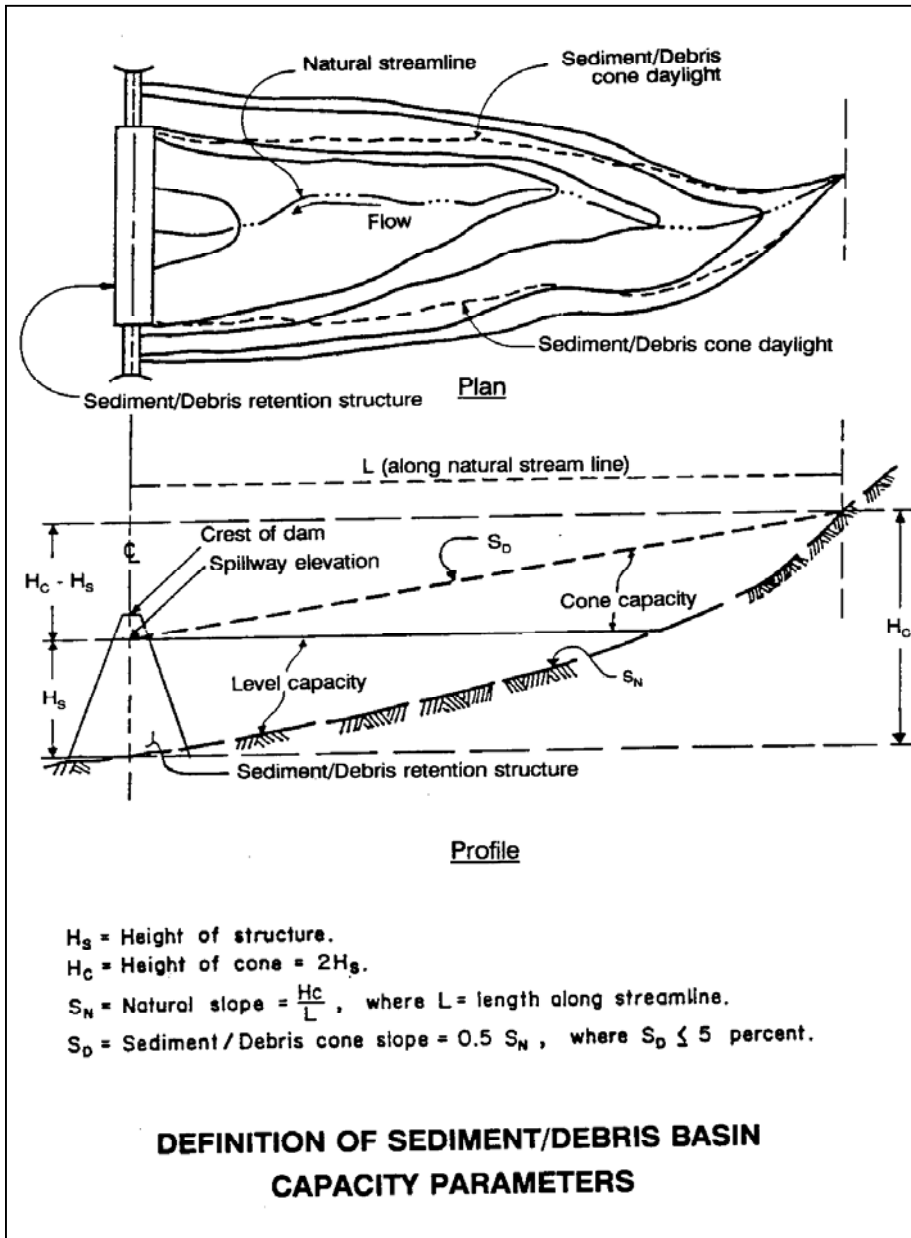

Figure 4.2.1
 Definition of Sediment/Debris
 Basin Capacity Parameters

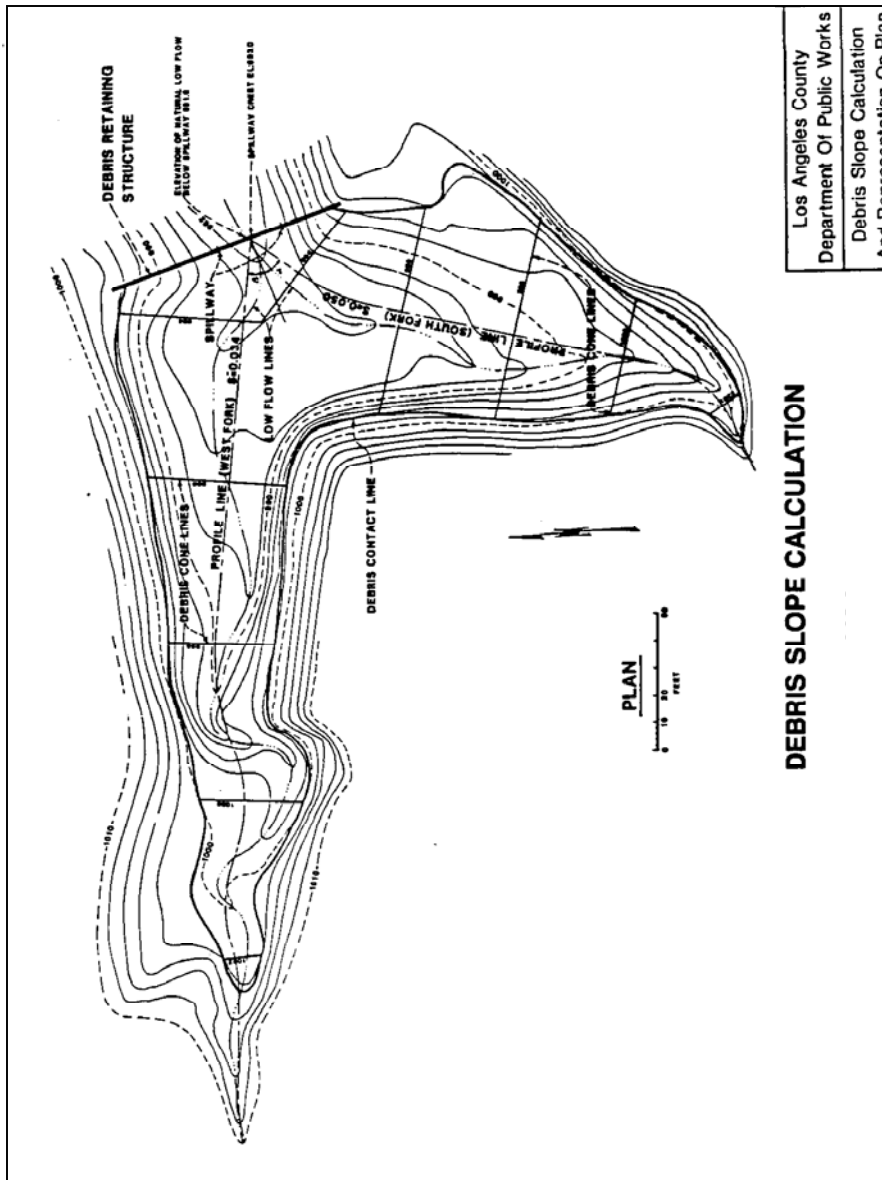

Figure 4.2.2
Debris Slope Calculation

Momentum Overflow

In the 1969 and the 1978 storms, some locations experienced unexpected events where significant amounts of sediment overflowed the spillway or dam before the basin was full. This type of event has been referred to as "Momentum Overflow."

It is believed that there are many contributing factors to this phenomenon. Some of the important factors are: rainfall amounts and intensity; watershed size, slope, shape, and condition (burned or unburned); soil composition; Debris Potential Area zone; debris basin shape; total versus cone capacity of the basin; slope of the upstream dam face; and the spillway location.

The likelihood of "Momentum Overflow" is reduced if the following design criteria are met for the sediment retaining facility:

- The cone slope is limited to a maximum of five percent.
- The level capacity is large enough to accommodate at least 50 percent of the debris event.

4.3 STANDARD SEDIMENT CONTROL METHODS

Appendix E includes a table comparing the design criteria for debris basins, elevated inlets, and desilting inlets.

Debris Basin

Public Works' Debris Dams and Basins Design Manual provides the specific design criteria for a debris basin. Appendix D contains a debris basin design example.

The criteria listed below amends the criteria given in Public Works' Debris Dams and Basins Design Manual.

- The horizontal alignment should be located in the original watercourse where the dam is perpendicular to the flow path. The longer dimension of the basin shall fall along the flow line.
- For the design of the outlet tower and conduit, refer to the section on Outlet Works in Public Works' Debris Dams and Basins Design Manual.

- Gage boards are required on basins under State Jurisdiction. Sediment lines need to be painted on the tower, marking from the lowest port invert suffice for all others. See the section on Gage Board Pipe Support in Public Works' Debris Dams and Basins Design Manual.
- The earth embankment slope, upstream and downstream, should be less than or equal to 3H:1V. Steeper slopes require a complete geotechnical stability analysis. Refer to the section on Earthen Dam Design in Public Works' Debris Dams and Basins Design Manual for more information.
- The embankment crest top width of the berm over the inlet shall be 20-feet paved with 3 inches of asphalt concrete. A berm width of 15-feet may be approved if geological analysis is provided to support the reduction.
- The facing slab shall be 6-inch concrete or gunite with No. 5 reinforcing steel at 18-inch spacing each way. See the section on Earthen Dam Design, Protection for Dam Slopes in Public Works' Debris Dams and Basins Design Manual.
- For trash barrier design, refer to the Debris Barrier section in Public Works' Debris Dams and Basins Design Manual.
- For access road and ramp design, refer to the Access to Dam and Basin section in Public Works' Debris Dams and Basins Design Manual. Access roads with 12-foot wide paving (3-inch asphalt concrete on 4-inch crushed aggregate base) within a 15-foot easement with a minimum turning radius of 40 feet can be used for structures with capacity less than 20,000 cubic yards. Access ramps are required. Unpaved ramps require slopes less than 10 percent. Paved ramps (3-inch asphalt concrete on 4-inch crushed aggregate base) require slopes less than or equal to 12 percent.
- For fencing, totally secure the basin area and inlet by 5-foot high fencing per APWA standard drawing 600-0.
- For fencing, structural design, hydraulic design, ponding, freeboard, drain size, inlet design capacity, and sediment capacity, refer to the respective section in Public Works' Debris Dams and Basins Design Manual.

Figure 4.3.1 shows a typical debris basin design.

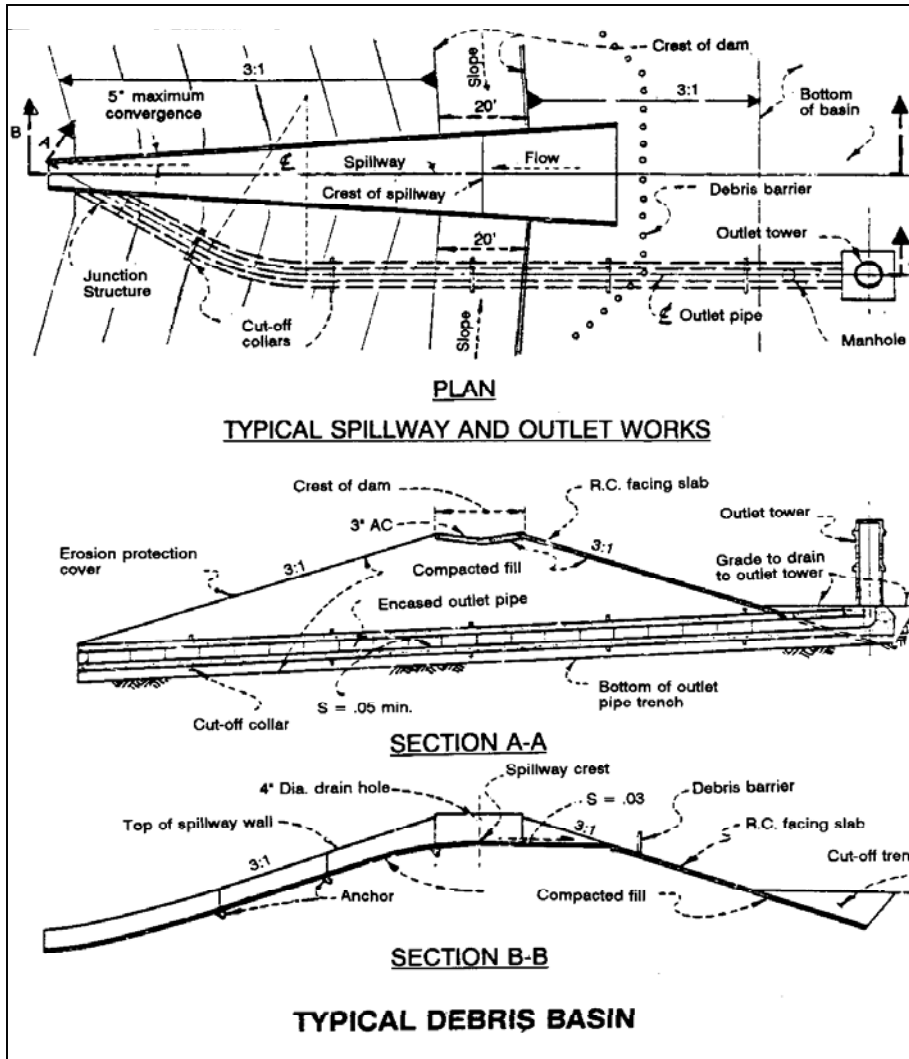

Figure 4.3.1
Typical Debris Basin

Elevated Inlet

Elevated inlets can be used if the conditions listed below are met. The design concept for all elevated inlets must be approved by Public Works prior to proceeding to final plans.

The following general criteria supplements the design criteria given in Public Works' Debris Dams and Basins Design Manual

- The location of an elevated inlet should be on a street or other safe path if available, to convey the water and sediment.
- The horizontal alignment should be located in the original watercourse where the dam is perpendicular to the flow path. The longer dimension of the basin shall fall along the flow line.
- A standard concrete outlet tower and conduit is required except in phased upstream development where corrugated metal pipe (CMP) tower with a concrete base may be substituted. The tower base can be modified to include a cleanout drain with a cover plate to allow flushing of the conduit. Extend the encasement on the conduit to the junction with the mainline or to a point where a 3H:1V slope originating from the intersection of the upstream face and the design headwater elevation meets the conduit, whichever is less.
- Gage boards of sediment lines painted on towers, marking from the lowest port invert can be used.
- The earth embankment maximum berm slope shall be 3H:1V. Steeper slopes require a complete geotechnical stability analysis. Refer to the section on Earth Dam Design in Public Works' Debris Dams and Basins Design Manual for further information.
- The embankment crest top width of the berm over the inlet shall be 20-feet paved with 3 inches of asphalt concrete. A berm width of 15-feet may be approved if geological analysis is provided to support the reduction.
- The facing slab shall be 6-inch thick reinforced concrete with reinforcing steel (no wire mesh) extending to the canyon wall. Air placed concrete is acceptable. Provide facing slabs around the basin wall if the cut and fill method is used to obtain the capacity.

- For trash barrier design, a swinging trash rack is required for conduits greater than 48-inches in diameter. A sloping trash rack per LACDPW 3089-0 can be used for smaller conduits. Discuss with Design Division prior to using a sloping trash rack especially in locations where organic debris may present a significant problem and may lead to clogging up the trash rack. Trash posts spaced at 4-feet or $2/3$ the diameter of the conduit, whichever is smaller, are also required at all elevated inlets.
- For access road and ramp design, refer to the Access to Dam and Basin section in Public Works' Debris Dams and Basins Design Manual. A vehicular access road into the basin must be provided at least 12-feet wide within a 15-foot easement, paved with 3 inches of asphalt concrete over 4 inches of crushed aggregate base. Access ramps are required. Unpaved ramps require slopes less than 10 percent. Paved ramps (3-inch asphalt concrete on 4-inch crushed aggregate base) require slopes less than or equal to 12 percent.
- For fencing, refer to the section on Fencing in Public Works' Debris Dams and Basins Design Manual and totally secure the basin area and inlet by 5-foot high fencing per APWA standard drawing 600-0.
- For hydraulic design, base the design of the inlet and storm drain on requirements stated in Public Works' Hydraulic Design Manual.
- The maximum allowable ponding at the drain shall be 3-feet above soffit of the conduit inlet.
- The minimum freeboard at the inlet is 2-feet above the maximum water surface elevation.
- The minimum drain size is 36-inch RCP and the maximum drain size is 84-inch RCP or an equivalent RC Box.
- Design the inlet and storm drain to convey the burned flow rate and the fully developed watershed flow rate, whichever is higher.
- For structural design, refer to the section on Structural Design in Public Works' Debris Dams and Basins Design Manual.
- The maximum allowable capacity of sediment in DPA zones 1-4 is 4,999 cubic yards and in DPA zones 5-11 is 19,999 cubic yards.

If for any reason an elevated inlet cannot meet the requirements, then a debris basin is required. A typical elevated inlet is shown in Figure 4.3.2.

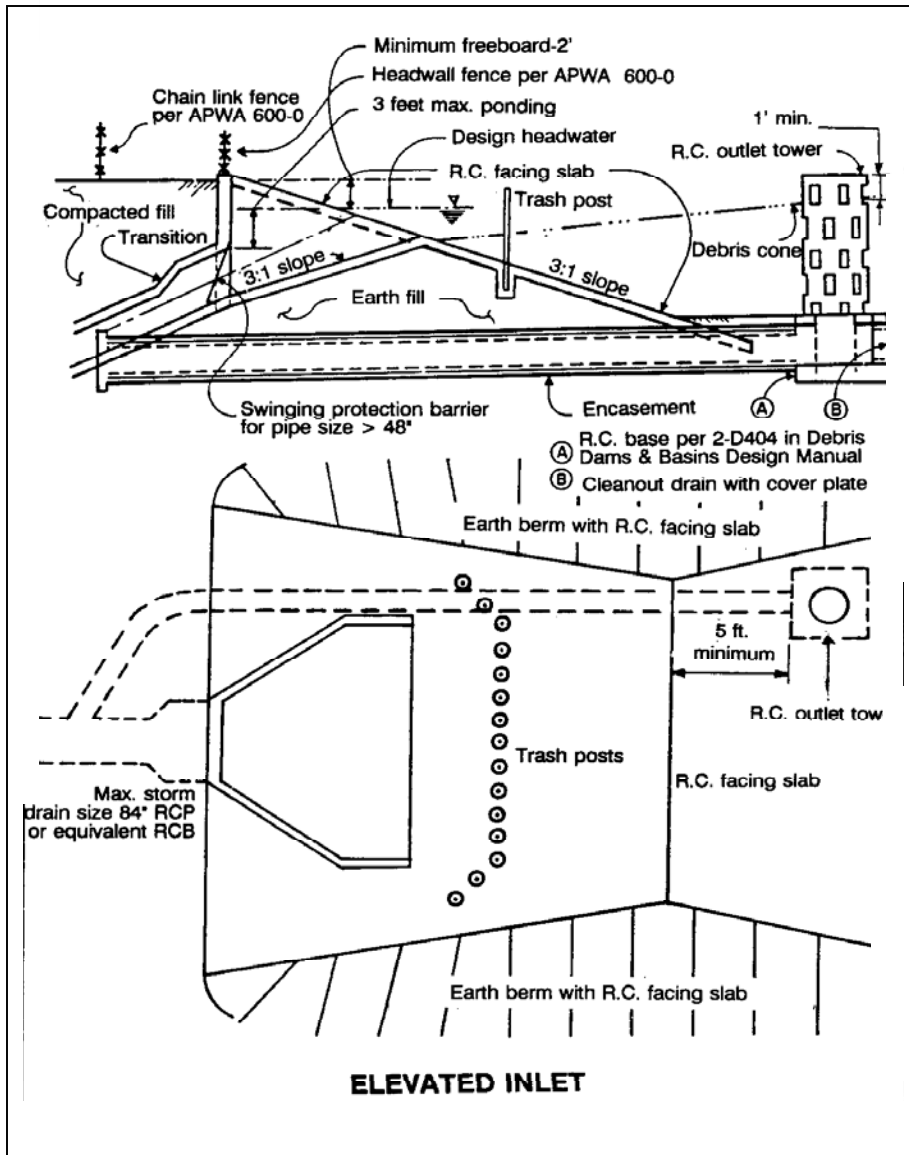

Figure 4.3.2
Elevated Inlet

Desilting Inlet

Desilting inlets can be used if the conditions comply with the requirements for a desilting inlet indicated below. The design concept for this inlet must be approved by Public Works prior to proceeding to final plans.

The following general criterion supplements the design criteria given in Public Works' Debris Dams and Basins Design Manual.

- The location of an elevated inlet should be on a street or other safe path if available, to convey the water and sediment.
- The horizontal alignment should be located in the original watercourse where the dam is perpendicular to the flow path. The longer dimension of the basin shall fall along the flow line.
- A corrugated metal pipe outlet tower and pipe is required upstream of the desilting wall.
- Gage boards of sediment lines painted on towers, marking from the lowest port invert can be used.
- The earth embankment must be protected between the desilting wall and the inlet with a reinforced concrete facing slab. Air placed concrete is acceptable.
- The embankment crest top width of the berm over the inlet shall be 20-feet paved with 3 inches of asphalt concrete. A berm width of 15-feet may be approved if geological analysis is provided to support the reduction.
- The facing slab shall be 6-inch thick reinforced concrete with reinforcing steel (no wire mesh) extending to the canyon wall. Air placed concrete is acceptable. Provide facing slabs around the basin wall if the cut and fill method is used to obtain the capacity.
- For trash barrier design, a sloping trash rack per LACDPW 3089-0 and trash posts spaced at $2/3$ the diameter of the conduit are required.
- For access road and ramp design, refer to the Access to Dam and Basin section in Public Works' Debris Dams and Basins Design Manual. A vehicular access road into the basin must be provided at

least 12-feet wide within a 15-foot easement, paved with 3 inches of asphalt concrete over 4 inches of crushed aggregate base.

- Access ramps are required. Unpaved ramps require slopes less than 10 percent. Paved ramps (3-inch asphalt concrete on 4-inch crushed aggregate base) require slopes less than or equal to 12 percent.
- For fencing, refer to the section on Fencing in Public Works' Debris Dams and Basins Design Manual and totally secure the basin area and inlet by 5-foot high fencing per APWA standard drawing 600-0.
- For hydraulic design, base the design of the inlet and storm drain on requirements stated in Public Works' Hydraulic Design Manual.
- The maximum allowable ponding at the desilting wall shall be 3-feet above the soffit of the drain.
- The minimum freeboard at the inlet is 2-feet above the maximum water surface elevation.
- The minimum drain size is 36-inch RCP and the maximum drain size is 48-inch RCP or an equivalent RC Box.
- Design the spillway notch and the inlet to pass the burned flow rate and the fully developed watershed flow rate, whichever is higher.
- For structural design, refer to the section on Structural Design in Public Works' Debris Dams and Basins Design Manual. Contact Design Division for additional information.
- The maximum allowable capacity of sediment in DPA zones 1-4 is 999 cubic yards and in DPA zones 5-11 is 4,999 cubic yards.
- The maximum desilting wall height is 6-feet.
- Design the desilting wall to withstand the overflow of the total burned and bulked flow rate.

Under certain favorable conditions, watersheds in DPA 5-11 and producing less than 1,000 cubic yards of sediment can be considered for a sediment-carrying conduit. If a desilting inlet cannot meet the requirements, then an elevated inlet or better is required. A typical desilting inlet is shown in Figure 4.3.3.

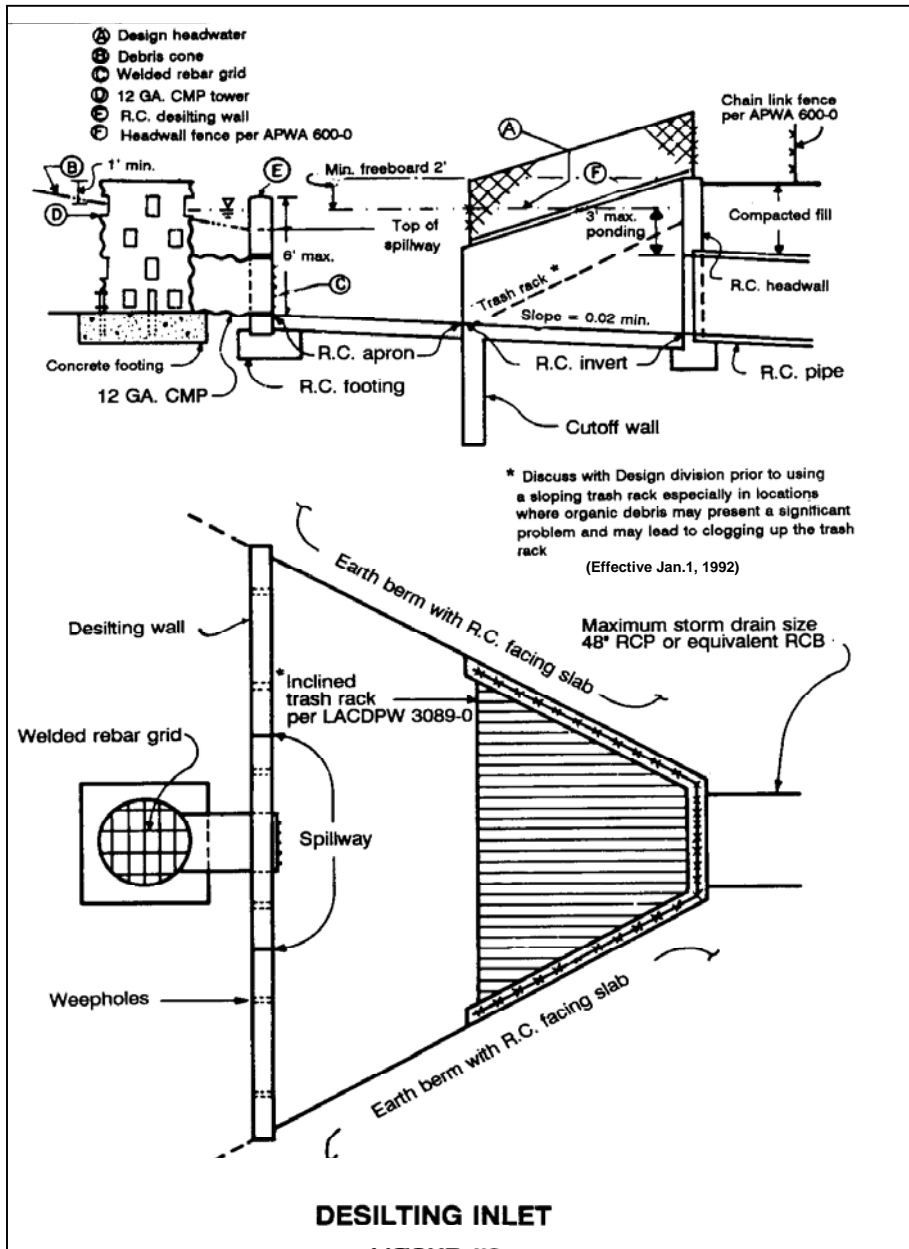

Figure 4.3.3

Desilting Inlet

4.4 OTHER SEDIMENT CONTROL METHODS

Public Works' pre-approval must be obtained at the design concept stage if other sediment control methods are proposed. The design criteria for alternative sediment control methods are described in the following sections.

Crib Dam

The crib dam structure was originally developed to stabilize streambeds. However, it can replace an earthen dam for debris basins with limited space. The structure is made of a cribbing framework of concrete members and the resulting cells are filled with aggregate. The height is controlled by the allowable stresses in the crib members and is generally not greater than 25 feet. An example of a crib dam is shown in Figure 4.4.1.



Figure 4.4.1
Crib Dam

A design manual for crib dams is currently not available from Public Works. Contact Public Works' Design Division for design details of the structure. For other design details including outlet works, refer to Public Works' Debris Dams and Basins Design Manual.

The following general criteria supplements the design criteria given in Public Works' Debris Dams and Basins Design Manual.

- Design the spillway as wide as possible to provide maximum spreading of the flow, and hence reduce stream energy to a minimum.
- Cap the portion of the crib structure to be used as a spillway with a reinforced concrete cover.
- Place the footing slab and the cribbing of the structure on a 6 horizontal to 1 vertical (6:1) upstream batter (see Figure 4.4.2).
- Construct a six-inch thick reinforced concrete facing slab with a 2 horizontal to 1 vertical (2:1) slope on the upstream face of the dam.
- Provide a sill at distance $H+18$ feet downstream from the structure to protect the dam from undercutting. Where H is the height of the structure in feet measured from the top of the slab to the water surface at maximum design flow depth.
- Construct a reinforced concrete slab or a grouted riprap slab between the sill and structure.
- Provide a separate channel headworks downstream of the sill to confine and direct the flow.
- Cut-off walls for both the sill and the dam shall be a minimum six feet deep or six inches into bedrock, whichever is less.

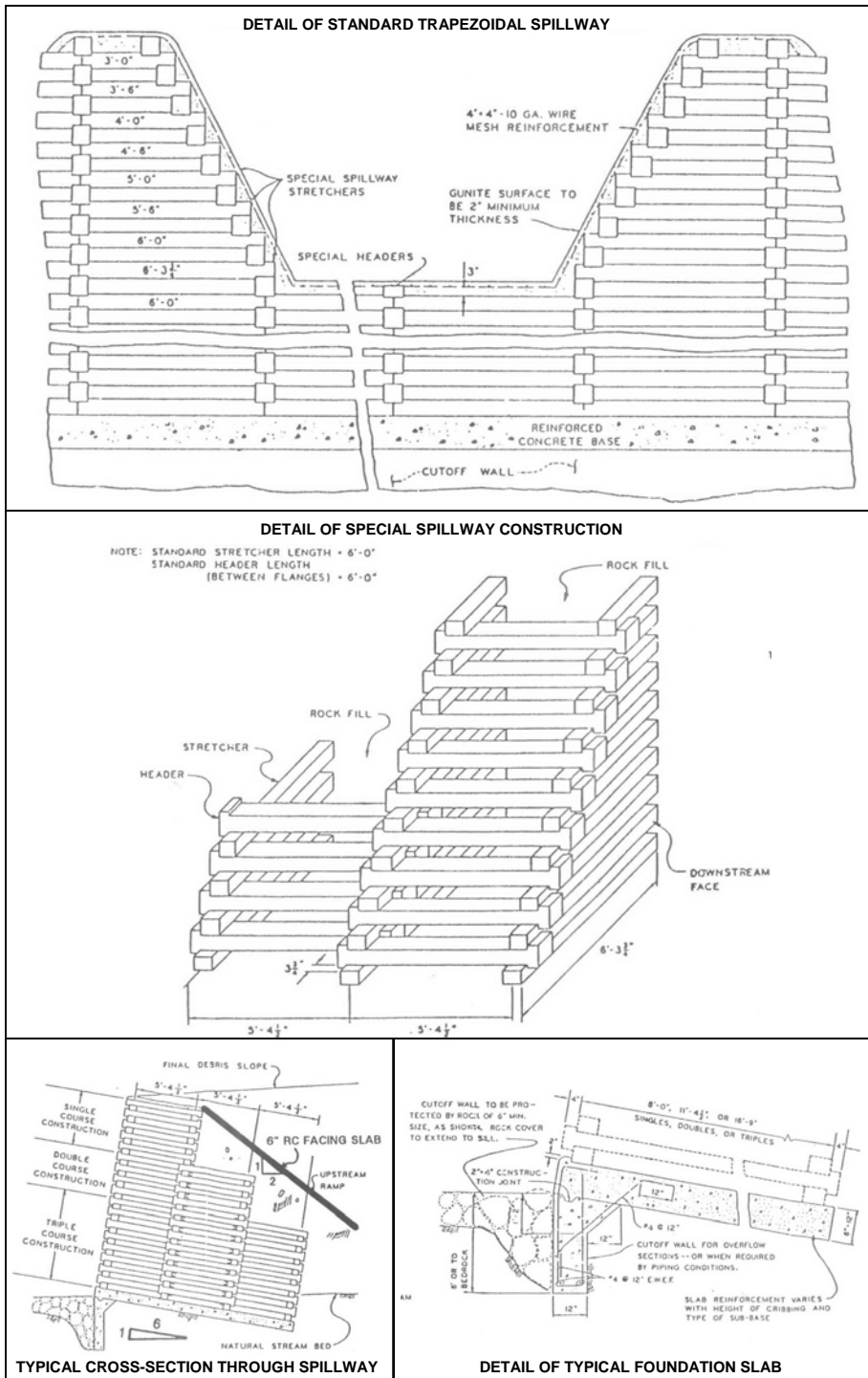

Figure 4.4.2
Crib Dam

Rail and Timber Structure

Rail and timber structures are primarily used as temporary emergency structures erected below recently burned areas where heavy sediment flows may prevent existing facilities from functioning properly. They are not to be permitted as permanent retention structures. They are generally designed and constructed by Public Works and kept in service until the watershed recovers from the burn.

The height of the structure (H) varies to a maximum 15 feet high with a reinforced concrete slab footing as shown in Figure 4.4.2. Refer to Public Works' Standard Plans manual (LACDPW 3085-0) for full design details of the structure.

Design the spillway to pass a Capital Flood peak flow rate, Q burned and bulked.

Provide access into the basin for cleanout purposes. On projects where a road cannot be provided, construct a removable panel in the barrier. For details of the road, refer to Public Works' Debris Dams and Basins Design Manual.

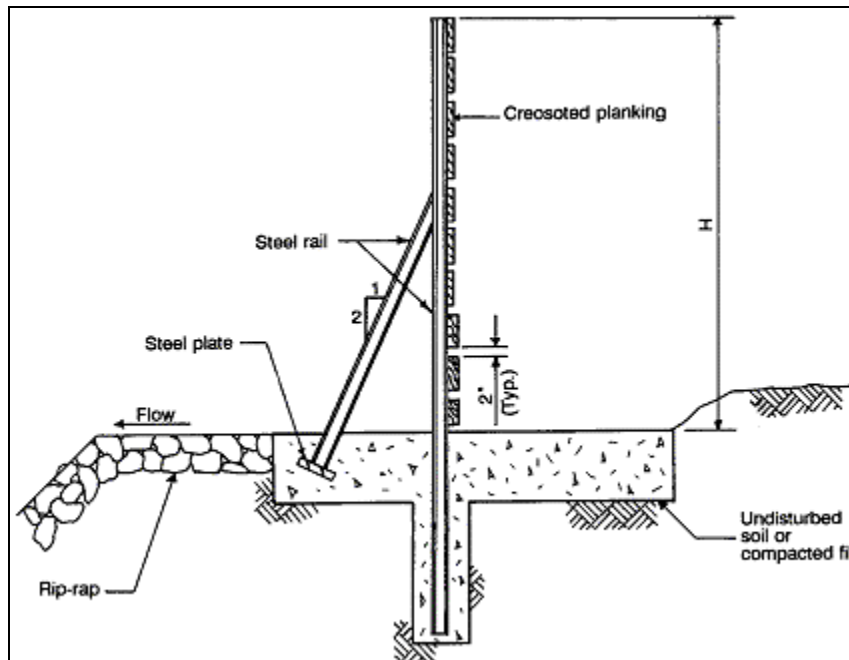

Figure 4.4.2

Rail & Timber Structure

Pit-type Basin

If a standard basin cannot be designed for the required capacity, a pit-type basin may be considered as shown in Figure 4.4.3.

Pit-type basins are generally considered subject to the momentum overflow phenomenon discussed in Section 4.2 and must be approved by Public Works prior to proceeding to final plans.

The type of outlet structure in a pit-type basin, as in any sediment retention basin, depends on the total sediment production. Refer to Appendix E to determine whether a debris basin, an elevated inlet, or a desilting inlet would be required for the design sediment production.

To design the basin capacity, first determine the cone slope then determine the storage ratio. The storage ratio is defined as the ratio of storage capacity below original ground to the total storage capacity (see Figure 4.4.3).

- If the storage ratio is greater than 0.7, the level capacity shall accommodate 100 percent of the design debris event.
- If the storage ratio is between 0.5 and 0.7, the level capacity shall accommodate at least 80 percent of the design debris event.

If the storage ratio is below 0.5, the level capacity shall accommodate at least 50 percent of the design debris event.

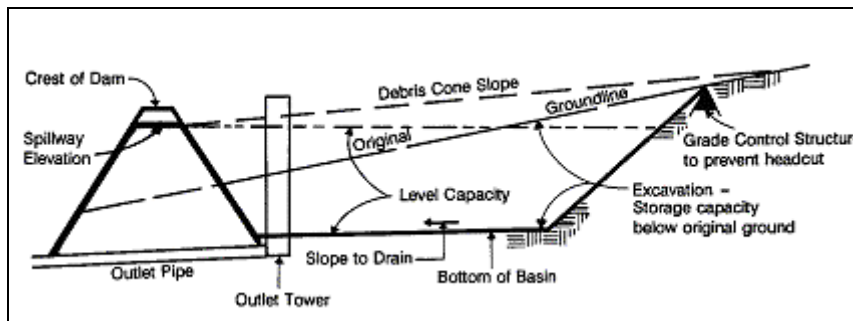

Figure 4.4.3

Pit-Type Basin

4.5 FLOOD RETENTION/DETENTION BASIN

The Public Works generally requires separate sediment and water retaining facilities. However, in special cases where sediment may deposit in a retention/detention basin, a combined facility may be accepted. Do not proceed with the design until approval is received from Public Works.

If Public Works accepts the combined facility, then the basin flow rate capacity is the difference between inflow versus outflow for the design flow rate of the facility. Refer to Chapter 2 for Public Works' policy on Level of Flood Protection and to the 2006 Hydrology Manual for the method of determining the runoff volume. Sediment storage capacity is equal to the design sediment production of the watershed. Determine the design sediment volume using the sediment production curves in Appendix B. The total capacity of the combined facility is the sum of the volume needed to control runoff and sediment. The total capacity must be located below spillway elevation as shown in Figure 4.5.1.

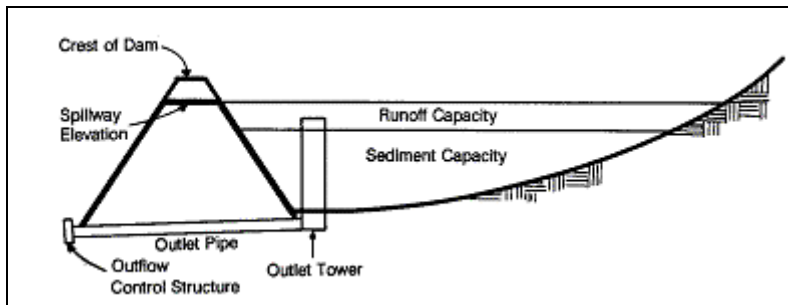

Figure 4.5.1
Flood Retention/Detention
Basin

Sediment Transport

5.1 INTRODUCTION

Sediment transport depends on the sediment particle size, shape, specific gravity, and on the flow velocity. Sediment may be transported as bedload or suspended load. Bedload is transported by sliding, rolling, and bouncing over the bed. Suspended load includes the finer portion of the bed material, which is intermittently suspended within the flow, and the wash load, which consists of particles too fine to settle to the channel bed. Figure 5.1.1 shows an example of sediment transport.



Figure 5.1.1

Example of Sediment Transport

Some of the more commonly used methods to determine sediment transport capacity are:

- Meyer-Peter, Muller Equation (MPM)
- Einstein Bed Load Equation
- Einstein Suspended Load Methodology
- Colby Methodology

Human activities can disturb the natural conditions of watercourses. Such activities include developments that encroach on the floodplain, construction of sediment trapping facilities, and gravel mining operations.

Public Works' general policy for the Santa Clara River and major tributaries is included in Section 2.2. This policy promotes the use of soft-bottom channels to pass sediment through the system where practical. Use debris or sediment control and hard bottom (concrete) channels very sparingly, primarily to be compatible with existing improvements.

The most desirable soft-bottom channel is one that does not degrade or aggrade. This channel is said to be in equilibrium. Developments encroaching on the floodplain reduce the channel width and increase the flow velocity. This increases the sediment transport capacity, which leads to invert degradation. Point stabilizers or drop structures may be used to prevent the scour from undermining the levee lining. If a reach is naturally aggrading, channelization can help increase the reach sediment transport capacity to approach the state of equilibrium.

Sediment control facilities and gravel mining operations may significantly decrease the rate of sediment supplied to downstream reaches. This causes the channel bed immediately downstream to erode. A hard-bottom (concrete) channel or soft-bottom channel with a series of drop structures would be necessary to convey the sediment deficient flows.

5.2 SOFT-BOTTOM CHANNELS WITH LEVEES

Under normal conditions, a sediment balanced soft-bottom channel is desired with proper design of the invert slope and channel width.

Conveyance Hydraulics, Erosion, Deposition

Levee failures can be due to general invert scour, bend scour, and/or local scour. Channelization, therefore, needs smooth transitions between varying sections and large radius bends. In addition, bridge abutment protection needs to be tied back or blended into the levee lining.

Sediment transport may be estimated through use of the procedures listed in Section 5.1. For a given channel width, an equilibrium slope can be calculated in a specific reach to satisfy the sediment continuity relationship where sediment transport through the improved reach is equal to the sediment supply into the reach.

$$Q_{S_{in}} = Q_{S_{out}}$$

Equation 5.2.1

Scour Protection (Levee Toe-down)

Toe-down or cut-off depth is the depth to which the bank revetment must be extended below grade to prevent undermining as the bed elevation fluctuates. The requirement for toe-down is the total cumulative channel adjustments possible from long-term degradation, general scour, bend scour, local scour, low-flow incisement, and bed forms. For an example, see Appendix D.

Use a lower Manning's n of 0.025 to estimate scour depth for design of toe-down.

$$Z_{tot} = Z_{deg} + Z_{gs} + Z_{ls} + Z_{bs} + Z_i + \frac{1}{2}h$$

Equation 5.2.2

Where:	Z_{tot}	= Total potential vertical adjustment
	Z_{deg}	= Long-term degradation, see (a) below
	Z_{gs}	= General scour, see (b) below
	Z_{ls}	= Local scour, see (c) below
	Z_{bs}	= Bend scour, see (d) below
	Z_i	= Low-flow incisement, see (e) below
	h	= Bed form height, see (f) below

a) Long-Term Degradation (Z_{deg})

The first step in determining long-term degradation is to find the discharge predominantly responsible for channel characteristics. The dominant discharge may be taken as 25% of Public Works' Capital Flood discharge (Q_{cap}).

Long-term degradation (or aggradation) within a particular channel reach may be estimated through use of the equilibrium slope techniques. Equilibrium slope for a channel may be estimated using the following steps:

1. Identify the supply reach, the reach upstream of the channel that supplies the channel with sediment.
2. Compute the hydraulic parameters for the supply reach using the dominant discharge.
3. Using one of the sediment transport methods from Section 5.1 that is appropriate for the stream and the hydraulic parameters from step (2), compute the sediment transport rate for the supply reach. This value is known as the sediment supply rate ($Q_{S\ in}$).
4. Choose an invert slope for the channelized reach, normally milder than the natural slope.
5. Using that slope, compute the hydraulic parameters for the channel (the transport reach) for the dominant discharge.
6. Apply the same sediment transport equation used in step (3) to the transport reach and compute the sediment transport rate through the channel ($Q_{S\ out}$).
7. Compare $Q_{S\ in}$ and $Q_{S\ out}$:
 - If equal, then the slope chosen in step (4) is the equilibrium slope.
 - If $Q_{S\ in} > Q_{S\ out}$, increase the slope and repeat steps (5) and (6).
 - If $Q_{S\ in} < Q_{S\ out}$, decrease the slope and repeat steps (5) and (6).

The curves in Appendix C-1 (A, B, and C) may be used to estimate the equilibrium slope. These curves show the relationship between the percent increase in velocity resulting from channelization and the corresponding change in invert slope. By subtracting that change from the natural slope, you get the equilibrium slope. Each figure consists of four curves to account for various reductions in sediment supply that can result from sediment trapping facilities or gravel mining operations.

When using the curves in Appendix C-1, compute the percent increase in velocity using Public Works' Capital Flood discharge (Q_{cap}), and 25% of Q_{cap} . Use the higher percent increase in velocity to determine the equilibrium slope.

Application of the equilibrium slope calculations requires the identification of a suitable point from which the computed equilibrium slope pivots. If natural geological controls such as rock outcroppings or man-made grade control structures exist, these features can serve as pivot points. For a given reach with such controls, the slope adjustment will always pivot about the downstream control point.

$$Z_{deg} = L (S_o - S_{eq})$$

Equation 5.2.3

Where: L = Reach length from point of interest to downstream pivot point
 S_o = Existing slope
 S_{eq} = Equilibrium slope

If the amount of levee toe-down appears excessive because of long-term degradation, consider alternatives such as implementation of grade control structures along the channelized reach.

b) General Scour (Z_{gs})

For a given flood event with a given duration, the volume of the sediment deposited or eroded in a channel reach is simply the difference between the upstream sediment supply rate and the channel sediment transport rate. If the supply rate is greater than the transport rate, the reach aggrades. The aggradation must be considered in the design of the levee freeboard height (FB) (see "Embankment Protection (Levee Height)" in this section). If the transport rate is greater than the supply, general scour will occur. Any scour that results from this phenomenon must be considered in the design of the total levee toe-down dimension (Z_{tot}).

Utilization of a sediment routing model (e.g. QUASED¹, HEC-6², FLUVIAL-12³) of the stream system is the best method of estimating the potential general scour (or general aggradation) on a reach by reach basis. However, less elaborate methods using rigid bed hydraulic and sediment transport calculations may be used to estimate the imbalance between sediment-transport capacity and sediment supply between adjacent reaches.

The curve in Appendix C-3 may also be used to estimate the general scour for the proposed flow velocity.

c) Local scour (Z_{ls})

Local scour occurs near an obstruction to flow, such as bridge piers, embankments, and contractions. Maximum local scour occurs during peak flow, therefore, use the peak Capital Flood (Q_{cap}) to determine the local scour (Z_{ls}) for the particular obstruction.

Pier Local Scour:

Appendix C-4 shows the relationship between pier width (b), in feet, and local scour (Z_{ls}), in feet, for square-nose piers. The different curves are for different velocities upstream of the bridge piers.

Scour depth adjustment factors (K_1) for pier shape other than square nose are presented in the following table:

Type of Pier	Reduction Factor K_1
Square nose	1.0
Round nose	0.9
Cylinder	0.9
Sharp nose	0.8
Group of cylinders	0.9

Table 5.2.1

Scour Depth Adjustment Factors

The angle of attack of oncoming flow has a significant impact on the potential scour depths. The local scour depth (Z_{ls}) from Appendix C-4 is adjusted by the appropriate factor (K_2) from Appendix C-5. Appendix C-5 shows the relationship between the angle of attack (α), in degrees, and the local scour adjustment factor (K_2). Several curves are shown for different pier length to width ratios (L/b), where L is the length of the pier, and b is the width of the pier, both in feet.

Another adjustment (K_3), is needed to account for debris blockage around the pier.

$$K_3 = \left(\frac{b + d}{b} \right)^{0.65}$$

Equation 5.2.4

Where: d = Debris blockage in feet

Use four feet of debris blockage where a heavy floating debris load can be expected. Otherwise, discuss with Public Works' Water Resources and Design Divisions. See Example 3 in Appendix D.

$$\text{Pier local scour} = Z_{ls} \times K_1 \times K_2 \times K_3$$

Note:

1. Footings supported on soil or degradable rock strata shall be embedded below the maximum computed scour depth.
2. Footings on piles may be located above the lowest anticipated scour level if the piles are designed for maximum scour condition. For earthquake loading, assume only half of the maximum anticipated scour has occurred. For this case, a concept must be approved by Public Works prior to proceeding with design.

Abutment Local Scour:

Estimate the depth of local scour at sloping-wall abutments from the graph in Appendix C-6. The graph shows the relationship between the length an abutment protrudes into the flow path (a), in feet, and the depth of local scour (Z_s), in feet. Several curves are shown for different velocity (V) and depth (Y) combinations.

Appendix C-6 is applicable to non-vertical walled abutments with embankment projection (a) less than 25 times the depth (Y). If the abutment terminates at a vertical wall, then multiply the scour depth (Z_s) estimated from Appendix C-6 by a factor of 2.0.

Figure 5.5.2 shows an example of abutment local scour at the Harding Street Bridge over Pacoima Wash.

**Figure 5.5.2**

Abutment Scour at
Harding Street over
Pacoima Wash
August 25, 2005

Levee Local Scour:

For soft bottom channels where the flow may possibly carry large debris (tree logs, boulders, etc.), increase the levee toe-down depth by 2 feet to account for local scour.

d) Bend Scour (Z_{bs})

This is the scour induced on the channel bed along the outside banks of channel curves.

Graphs in Appendix C-7A-C show the relationships between the ratio of the channel top width to radius of curvature (W/R) and the bend scour (Z_{bs}), in feet, for three different energy slopes (S_e). Energy slope (S_e) is the slope of the energy gradient. Several curves are shown in each graph for different velocity (V) and depth (Y) combinations.

The secondary currents that create bend scour extend for some distance beyond the downstream end of the channel bend. The relationship between the depth of flow within channel bend (Y), in feet, and the extent of scour downstream of channel bend (X), in feet, is shown on the graph in Appendix C-8. Figure 5.5.3 shows an example of bend scour along the Santa Clara River.



Figure 5.5.3
Bend Scour on
Santa Clara River
August 25, 2005

e) Low Flow Incisement (Z_i)

The best means of estimating the likely depths of incisement is through field inspection by measuring the low flow channel depth. For design purposes use Z_i equal to measured low flow depth, or 2 feet, whichever is greater. Figure 5.5.4 shows an example of low flow incisement along the San Gabriel River.

**Figure 5.5.4**

Low Flow Incisement on
San Gabriel River
July 1, 1974

f) Bed Form Height (h)

Bed forms (dunes and antidunes) commonly develop in natural or man-made channels with sand beds. The distance between the mean bed elevation and the trough of the bed form is approximately equal to the distance from the mean bed elevation to the bed form crest, and the sum of these two distances is termed the bed form height.

The relationship between the mean channel velocity (V), in feet per second, and the bed form height (h), in feet, is shown on the graph in Appendix C-9. If the bed form height (h) from Appendix C-9 exceeds the flow depth, use the flow depth instead.

Total Toe-Down Requirement (Z_{tot}):

Levee toe-down, as stated in Equation 5.2.2, is the total of long-term degradation (Z_{deg}), general scour (Z_{gs}), bend scour (Z_{bs}), local scour (Z_{ls}), half the bed form height ($\frac{1}{2}h$), and low flow incisement (Z_i).

Compare to the levee toe-down computed using Public Works' Hydraulic Design Manual criteria Section F and use the larger value.

Embankment Protection (Levee Height)

The levees must be designed to contain the design flood plus adequate freeboard.

Freeboard is the vertical distance from the water surface elevation to the top of the levees. Freeboard represents the additional height required to ensure overtopping does not occur from factors not accounted for in the design water surface calculations. These factors include possible long-term aggradation, superelevation at curved channels, and bed forms, in addition to less identifiable components such as separation, excessive turbulence, wave action and variations in loss coefficients.

Use a larger Manning's n to compute water surface elevations for design of levee height. Manning's n cannot be determined based on vegetation coverage alone. It is a function of many other variables including sediment size distribution, surface roughness, channel irregularity, obstructions, channel alignment and slope, and flow characteristics such as discharge, depth, and velocity. These variables change from one site to another; therefore, a generic description of the type and density of vegetation with relation to Manning's n is not feasible. Several references, such as Open Channel Hydraulics by Ven Te Chow, provide methodologies to determine the appropriate Manning's n considering all these variables.

Freeboard allowance is defined:

$$FB = Y_{agg} + Y_{ga} + Y_{se} + \frac{1}{2} h$$

Equation 5.2.5

Where:

FB	= Total freeboard
Y_{agg}	= Long-term aggradation
Y_{ga}	= General aggradation
Y_{se}	= Superelevation
h	= Bed form height (from Appendix C-9)

Superelevation may be determined through application of the appropriate formula listed in Section C-3.1 of Public Works' Hydraulic Design Manual. Other components may be estimated with the same techniques presented under "Scour Protection".

Compare to the freeboard computed using criteria in Section C-4 of the Hydraulic Design Manual and use the larger value.

5.3 SOFT-BOTTOM CHANNELS WITH LEVEES AND STABILIZERS

Appropriate stabilization measures such as drop structures or point stabilizers may be required for soft-bottom channels. Appendix C-2 shows the allowed percent increase in velocity corresponding to the natural slope. Appendix C-2 has three curves to account for reduction in sediment supply that can result from sediment trapping facilities or gravel mining operations. If percent increase in velocity is higher than the allowable (above the curves) then invert stabilization is required. Figure 5.3.1 shows the San Gabriel River, an example of a soft-bottom channel with levees.



Figure 5.3.1
San Gabriel River –
Soft Bottom Channel with
Levees

Drop Structures

Drop structures (see Figures 5.3.2 and 5.3.3) are generally a conventional design with some type of stilling pool below the drop. The channel invert between the drop structures is graded to the design slope. See Example 4 in Appendix D.

The primary function of a drop structure is to decrease the gradient of a channel to create a condition of equilibrium (sediment inflow equal to sediment outflow). It also controls lateral bank migration and improves bank stability. The recommended maximum nominal height (H) for drop structures is typically five feet.

Place riprap downstream and upstream of the drop structure to reduce the effect of local scour. The mean riprap size is a function of the flow velocity. Appendix C-10 shows the relationship between the bottom velocity and the required riprap size. If channel velocity is beyond the range of the graph in Appendix C-10, an additional energy dissipation measure will be necessary other than riprap.

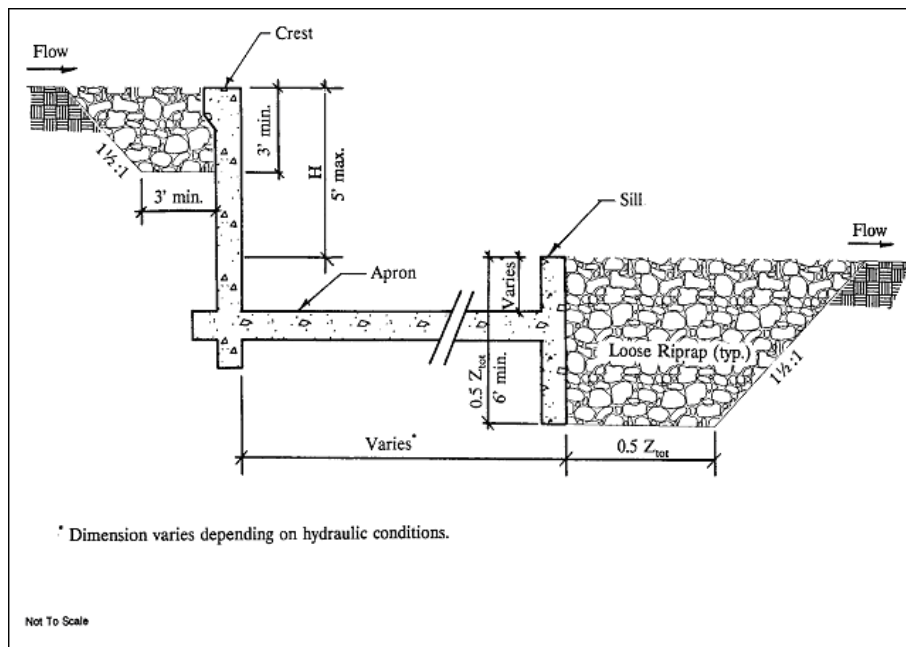

Figure 5.3.2
Drop Structure Drawing

**Figure 5.3.3**

Drop Structure along San Gabriel River

Point Stabilizers

The primary function of a point stabilizer (see Figure 5.3.4) is to maintain the stability of the natural streambed by controlling headcutting. The stabilizers are set at natural grade and buried to a sufficient depth to account for the scouring action that can occur during peak flows.

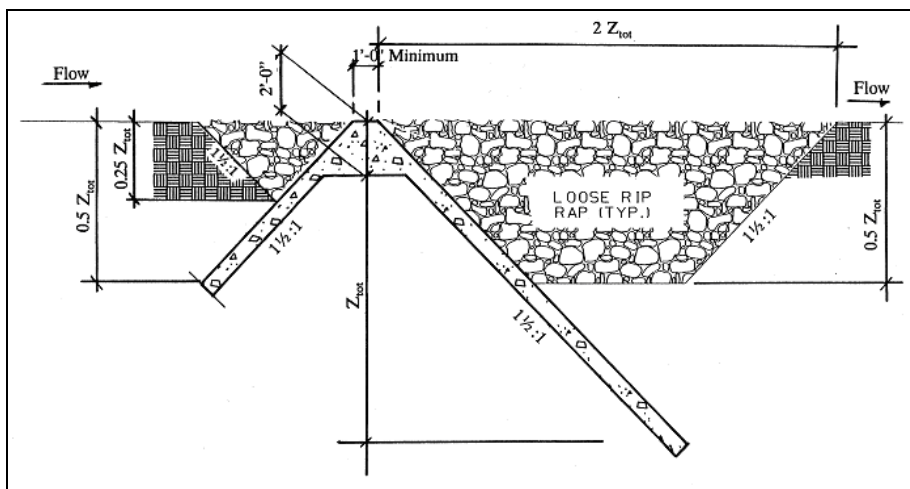
**Figure 5.3.4**

Point Stabilizer Drawing

Drop Height and Spacing

The design of grade-control structures is dependent upon the existing slope of the channel, the equilibrium slope (design slope) of the channel, the distance downstream to the nearest stable point in the channel, and the estimated scour hole depth below the structure under design flow conditions.

Determine the spacing of the invert stabilizers (D), from the following equation:

$$D = \frac{H}{(S_o - S_{eq})} \quad \text{Equation 5.3.1}$$

Where:

D	= Distance to the nearest downstream stable point
H	= Nominal height of grade control structure, 2' maximum for point stabilizers and 5' maximum for drop structures
S _o	= Existing channel slope
S _{eq}	= Equilibrium channel slope

Provide access ramps between invert stabilizers for channel maintenance.

5.4. HARD-BOTTOM (REINFORCED CONCRETE) CHANNELS

In the following cases, a soft-bottom channel is not feasible, and a concrete channel is needed:

- Sediment supply to the channel is significantly reduced or eliminated as in the case of a debris basin or a gravel mining operation.
- The invert slope is so steep that stabilizing the channel is not feasible.

To limit invert abrasion in concrete channels carrying sediment, design the channel based on the following criteria:

- Velocity of debris carrying flow shall not exceed 40 feet per second
- Design shall comply with Public Works' Structural Design Manual, Sections G-9 (steel clearances and additional cover over the reinforcing steel)

Concrete channels must be designed to prevent sediment deposition, which would reduce conveyance capacity. Deposited sediment has the dual impact of raising the bed level while increasing the roughness of the channel bed, which increases the channel flow resistance.

The minimum velocity required to keep the channel clear of sediment is known as the limiting deposit velocity (V_l). Graphs in Appendix C-11 show the relationship between the size of sediment for which 85 percent of the sediment is finer (d_{85}) and the limiting deposit velocity (V_l) in feet per second.

Follow the requirements discussed below for the design of concrete channels carrying bulked flow.

Provide a vehicular access road of at least 12-feet wide within a 15-foot easement, paved with 3 inches of asphalt concrete (A.C.) over 4 inches of crushed aggregate base (C.A.B.) on both sides of the channel. For freeboard and the hydraulic design, refer to Public Works' Hydraulic Design Manual. The design capacity of the channel or inlet and drain must be sized to pass the burned and bulked flow rate or the fully developed watershed flow rate, whichever is higher. For structural design, refer to Public Works' Structural Design Manual requirements for sediment carrying channels. The peak flow velocity shall be greater than the limiting deposit velocity for the size of material to be transported, but shall not exceed 40 feet per second. For junctioning, the angle of confluence shall not exceed 5° to 45° . Design the inlet to the concrete channel to accelerate flows into the drain. Provide a minimum slope of 2% for the invert slab.

Figure 5.4.1 shows the Rio Hondo Channel, an example of a hard-bottom concrete channel.

**Figure 5.4.1**

Rio Hondo Channel
December 15, 1977

5.5 CLOSED DRAINS

The minimum velocity required to keep the conduit clear of sediment is known as the limiting deposit velocity (V_l). Graphs in Appendix C-11 show the relationship between the size of sediment for which 85 percent of the sediment is finer (D_{85}) and the limiting deposit velocity (V_l) in feet per second.

Closed conduits carrying bulked flow may be used according to the conditions in Table 4.1.1 for inlet with bulked flow drain. The design concept must be approved by Public Works prior to proceeding to final plans. Follow the requirements listed below for design of closed conduits carrying bulked flow.

Do not locate a closed conduit drain under homes or other permanent structures. Provide a safe secondary overflow path for water and sediment. The horizontal alignment of the storm drain shall be straight. If bends are unavoidable, the radius of curvature shall be at least 30 times the width of pipe. The central angle shall not exceed 45 degrees. The maximum deviation computed by the ratio: actual length from inlet to outlet/junction over straight line distance from inlet to outlet/junction, shall be less than 1.1. A trash rack per LACDPW 3089-0 is required at the inlet. Trash posts should be spaced at $2/3$ the diameter of the conduit or 4 feet, whichever is smaller, are also required.

Provided a vehicular access road of at least 12-feet wide within a 15-foot easement, paved with 3 inches of asphalt concrete over 4 inches of crushed aggregate base. For hydraulic design, refer to Public Works' Hydraulic Design Manual. Pressure flow is not permitted in closed conduits.

Watersheds producing 1,000 cubic yards of sediment or greater require the use of an open channel (see Section 5.4) or a sediment control facility (see Chapter 4). See Figure 5.5.2 for a typical sediment carrying inlet and drain. Figure 5.5.1 shows a sediment-filled culvert.



Figure 5.5.1
Culvert Filled With Sediment
January 30, 1969

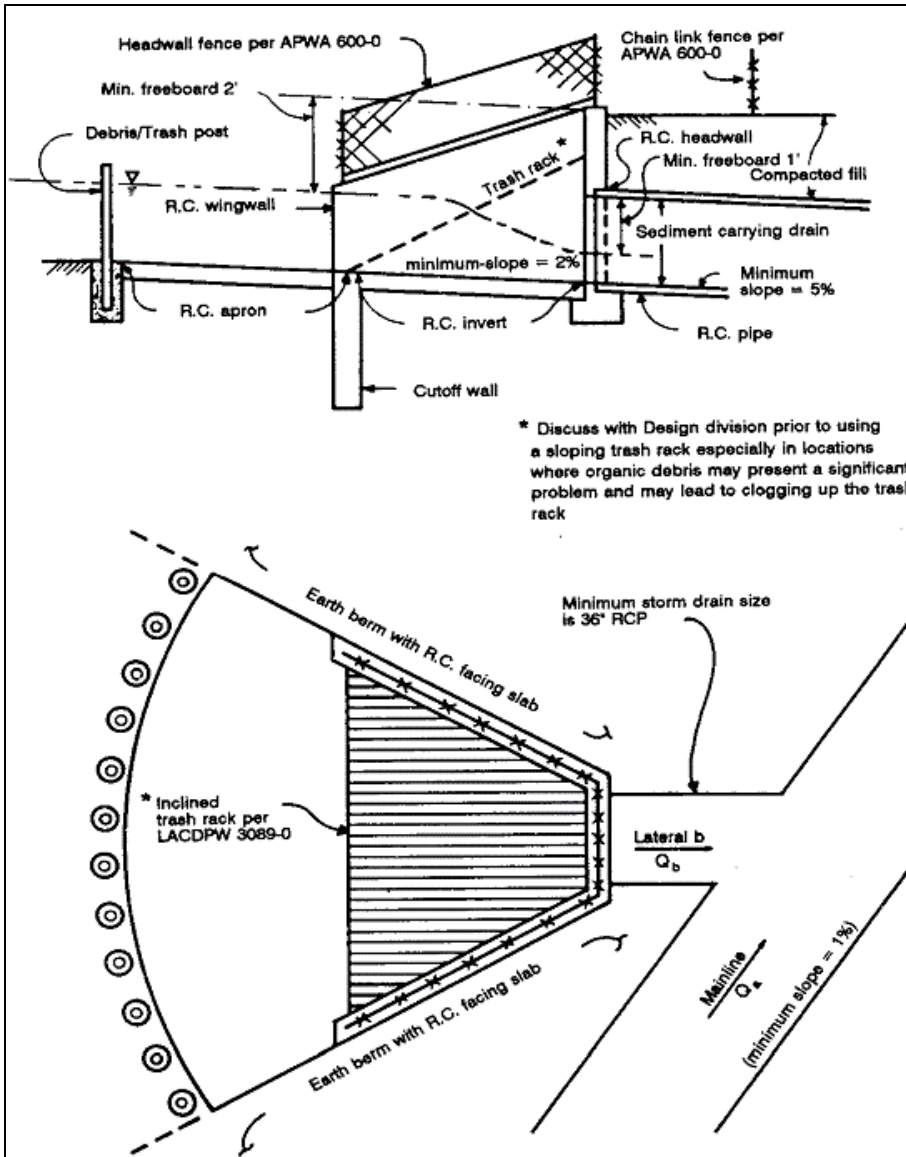

Figure 5.5.2
Sediment Carrying Inlet
and Storm Drain

5.6 INLET AND OUTLET DESIGN

Transition Design

Table 5.6.1 lists design considerations for transitions between different types of channels.

FROM	TO	DESIGN CONSIDERATIONS
Soft-bottom channel	Hard-bottom channel	<ul style="list-style-type: none"> • Provide adequate cut-off at beginning of concrete channel • Increase inlet slope to accelerate the flow to limiting deposit velocity (V_l) • Provide smooth transition angles • If transition is from an unimproved channel, extend wing walls to the floodplain limits
Hard-bottom channel	Soft-bottom channel	<ul style="list-style-type: none"> • Use energy dissipation structure to reduce velocities to natural velocity • If concrete channel outlets into an unimproved soft bottom channel, design the outlet to direct the flow to its natural path. Extend wing walls to flood plain limits
Unimproved channel	Stabilized Soft-bottom channel	<ul style="list-style-type: none"> • Extend wing walls to flood plain limits • Provide invert stabilizer at beginning of stabilized channel to control the grade • Provide smooth transitions
Stabilized Soft-bottom channel	Unimproved channel	<ul style="list-style-type: none"> • Design the outlet to direct the flow back to its natural path • Provide invert stabilizer at the end of stabilized channel to control the grade
Hard-bottom channel	Hard-bottom channel	<ul style="list-style-type: none"> • Keep velocities above limiting deposit velocity and below 40 feet per second

Table 5.6.1

Transition Design Considerations

Energy Dissipation

Storm drains and channels which outlet into a natural or improved soft bottom channel will generally require an energy dissipater to reduce velocities to a non-erosive magnitude. The type of dissipater structure depends on the approach velocity and the desired natural velocity. Consult Public Works' Design Division for type and design of energy dissipation structure.

In case of sediment laden-flows (bulked flow), the sudden drop in velocity usually causes deposition to occur at the upstream of the energy dissipation structure. Design the dissipater structure to minimize deposition and include provisions for access to remove the deposited sediment.

5.7 FLOODPROOFING OF DEVELOPMENTS IN NATURAL WATERCOURSES

Developments within the natural watercourse boundaries (that have been approved by Land Development Division) requiring flood proofing should follow the criteria in Section 5.2 to determine the scour depth and embankment height of local protection. Developers must prove through use of hydraulic and sediment transport analyses that their development will not have any adverse effect on neighboring properties such as increased flood hazard, scour, or deposition. Contact Land Development and Building & Safety Divisions for Public Works' drainage requirements.

¹ Quasi-Dynamic Sediment Routing Model - Developed by Simons, Li and Associates, Inc.

² Scour and Deposition in Rivers and Reservoirs - Developed by U.S. Army Corps of Engineers

³ Mathematical Model for Erodible Channels - Developed by Howard H. Chang, Ph.D

INDEX

A

Antelope Valley, 13, 14, 24

B

bed form height, 51, 58, 59

Bulked, 3, 6, 8–12, 27, 28, 46

flow, 21, 22, 24, 29, 30, 41, 64,
65, 69

flow hydrograph, 21, 24

Bulking, 3, 6, 21

constant, 24

exponent, 24

factor, 22, 23, 25, 27, 28

factor curve, 21, 24

C

Capital Flood, 6–8, 12, 46, 52–54

Colby Methodology, 50

cone slope, 31, 34, 47

crib dam, 43, 44

culvert, 7, 11, 66

D

Debris

basin, 1, 2, 5, 6, 14, 22, 30, 34,
36, 39, 43, 47, 63

Potential Area (DPA), 13, 29, 34

Production (DP), 14–20, 25, 26

Production Rate (DPR), 15–20,
25, 26

deposition, 11, 51, 64, 69

Design Debris Event (DDE), 14,
47, D-4

desilting inlet, 30, 34, 40, 42, 47

detention basin, 1, 7, 48

drop structure, 8, 50, 60, 61, 63

E

Einstein

Bed Load Equation, 50

Suspended Load Methodology,
50

elevated inlet, 30, 34, 37–40, 42,
47

erosion, 3, 11, 51

F

fire, 3, 21

freeboard, 35, 38, 41, 53, 59, 60,
64

L

level capacity, 31, 34, 47

Los Angeles

Basin, 13, 14, 24

low flow incisement, 51, 58, 59

Index

M

Manning n value, 51, 59
Meyer-Peter, Muller Equation
(MPM), 50
momentum overflow, 34, 47
mud flood, 4, 5
mudflow, 5, 30

N

natural watercourse, 6, 69

P

pit-type basin, 47
point stabilizer, 50, 60, 62, 63

R

rainfall intensity, 2, 13
riprap, 44, 61

S

Santa Clara River, 8–12, 50, 57
Basin, 8, 13, 14, 24
Scour, 50, 51, 69
bend, 51, 53, 57, 59
general, 51, 53, 54, 59
local, 51, 54–59, 61
protection, 51, 60
superelevation, 59, 60

LIST OF SYMBOLS

SYMBOL	DEFINITION
A	= Total drainage area, including developments
A_i	= Individual drainage area
A_u	= Total undeveloped area
A_d	= Total developed area
A_{di}	= Developed area, in area A_i
a	= Bulking constant (fixed throughout the hydrograph)
a	= Length which abutment protrudes into the flow
α	= Angle of attack
BF	= Bulking factor
$BF_{(A_i)}$	= Bulking factor based on area, A_i
b	= Pier width
C	= Capacity of sediment control structure
D	= Distance to the nearest downstream stable point
d	= Debris blockage
DP	= Debris production
DPA	= Debris potential area
DPR	= Debris production rate
$DPR_{(A)}$	= Debris production rate based on the total drainage area A
$DPR_{(A_i)}$	= Debris production rate based on area, A_i
$DPR_{(A_u)}$	= Debris production rate based on the total undeveloped drainage area, A_u
$DPR_{i(A_i)}$	= Debris production rate based on area A_i in DPA zone i
d_{85}	= Size of sediment for which 85 percent of the sediment is finer
FB	= Total freeboard
G	= Multiplication factor
g	= Acceleration of gravity
H	= Nominal height of grade control structure
H_c	= Height of debris cone
H_s	= Height of spillway above natural ground
h	= Bed form height
L	= Reach length
L	= Length of pier
K_1	= Scour depth adjustment factor
K_2	= Local scour adjustment factor

SYMBOL**DEFINITION**

K_3	=	Local scour depth adjustment factor to account for debris blockage around pier
n	=	Bulking exponent (fixed throughout the hydrograph)
n	=	Manning's roughness coefficient for the channel
Q	=	Clear or burned discharge
Q_B	=	Bulked or burned and bulked discharge
Q_b	=	Bulked flow discharge
Q_{cap}	=	Department's Capital Flood discharge
Q_s	=	Sediment discharge
$Q_{S\ in}$	=	Sediment supply into the reach
$Q_{S\ out}$	=	Sediment transport out of the reach
Q_w	=	Water discharge (clear or burned)
Q_{10}	=	10 year runoff discharge
R	=	Radius of curvature
S_o	=	Existing slope
S_e	=	Energy slope
S_D	=	Sediment/Debris cone slope
S_{eq}	=	Equilibrium slope
S_g	=	Specific gravity
S_N	=	Natural slope of the stream
V	=	Velocity of flow
V_l	=	Limiting deposit velocity
V_{lmax}	=	Maximum limiting deposit velocity
W	=	Channel top width
Y	=	Depth of flow
Y_{agg}	=	Long-term aggradation
Y_{ga}	=	General aggradation
Y_{se}	=	Superelevation
Z_{bs}	=	Bend scour
Z_{deg}	=	Long-term degradation
Z_{gs}	=	General scour
Z_i	=	Low-flow incisement
Z_{ls}	=	Local scour
Z_{tot}	=	Total potential vertical adjustment

REFERENCES¹

American Society of Civil Engineers (ASCE), "Manuals and reports on engineering practice," Number 54, Sedimentation Engineering

Chow, Ven Te, Open Channel Hydraulics

Ferrel, William F., Los Angeles County Flood Control District report published in November 1959 on "Debris Reduction Studies for Mountain Watersheds"

Simons, Li & Associates, "Fluvial Study of the Santa Clara River and its Tributaries" prepared for the Los Angeles County Department of Public Works, November 1990

¹ This is a partial list.

APPENDIX A

Hydrologic Maps

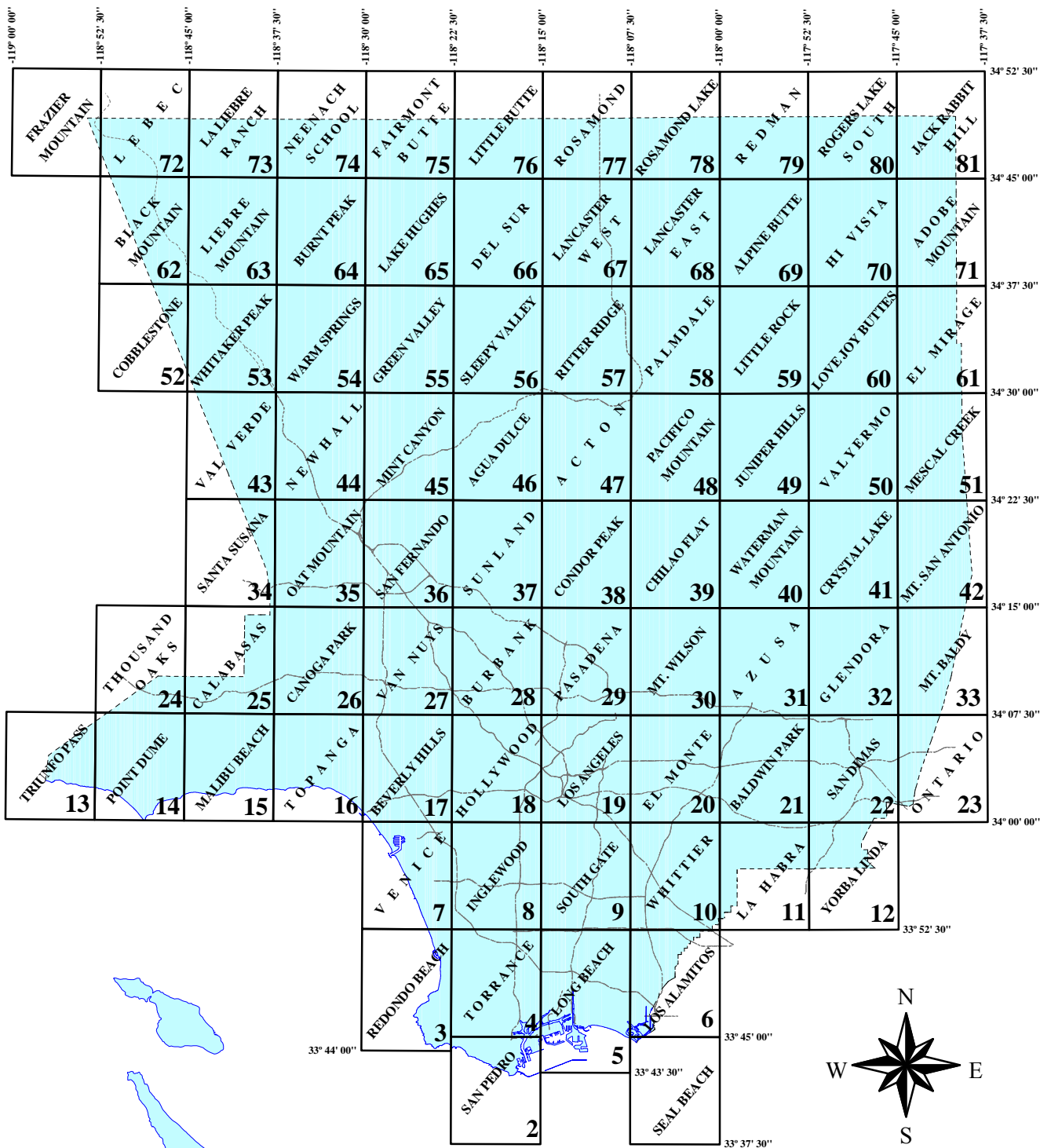

INDEX ISOHYETAL MAP

50-YEAR 24-HOUR ISOHYET

BASED ON USGS QUADRANGLE



33° 45' 00"

TORRANCE 1-H1.4

-118° 22' 30"

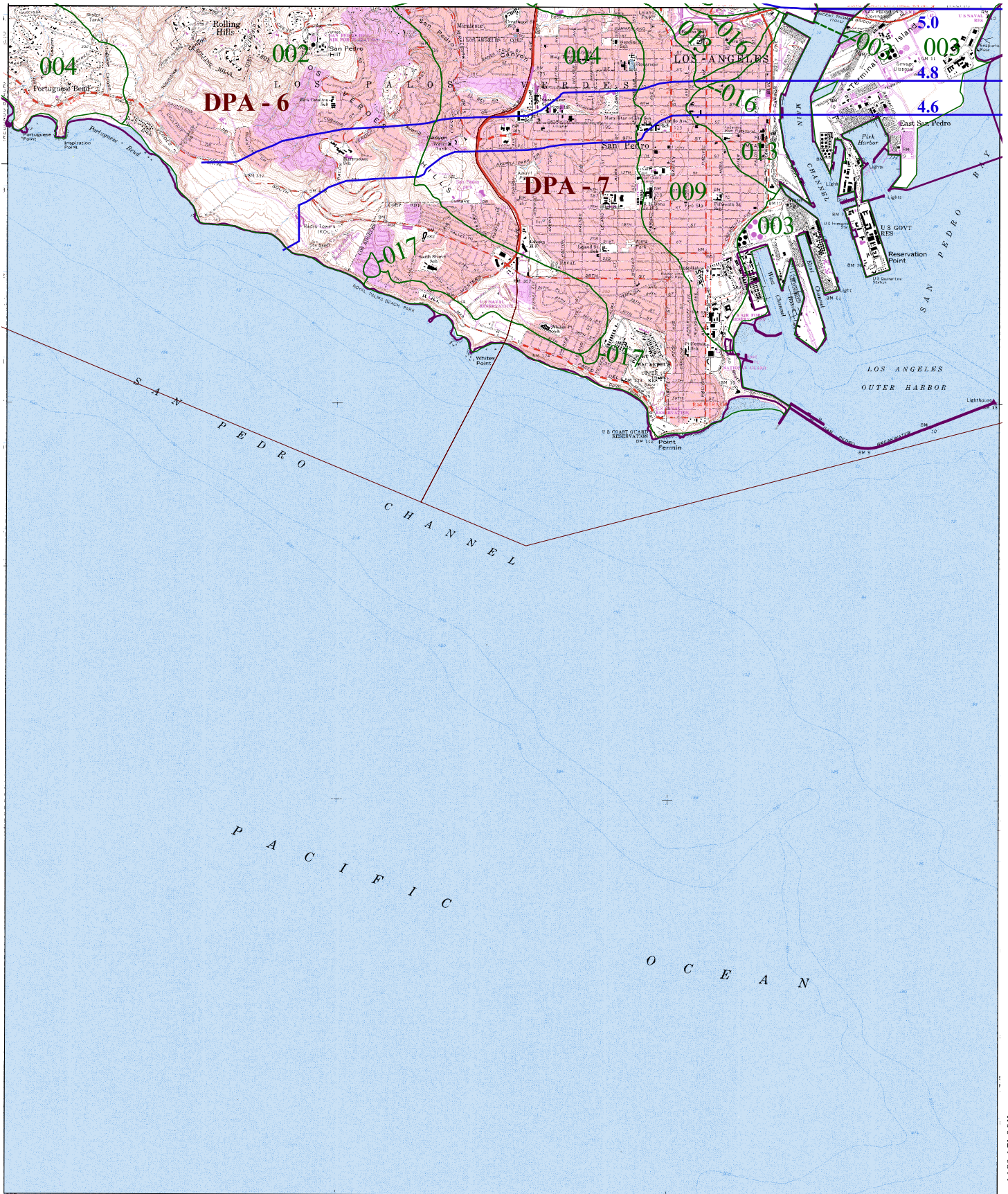

-118° 15' 00"

33° 37' 30"



016

SOIL CLASSIFICATION AREA

7.2

INCHES OF RAINFALL

DPA - 6

DEBRIS POTENTIAL AREA

1 0 1 2 Miles

25-YEAR 24-HOUR ISOHYET REDUCTION FACTOR: 0.878
10-YEAR 24-HOUR ISOHYET REDUCTION FACTOR: 0.714

SAN PEDRO 50-YEAR 24-HOUR ISOHYET

1-H1.2



33° 52' 30"

VENICE 1-HI.7

-118° 30' 00"

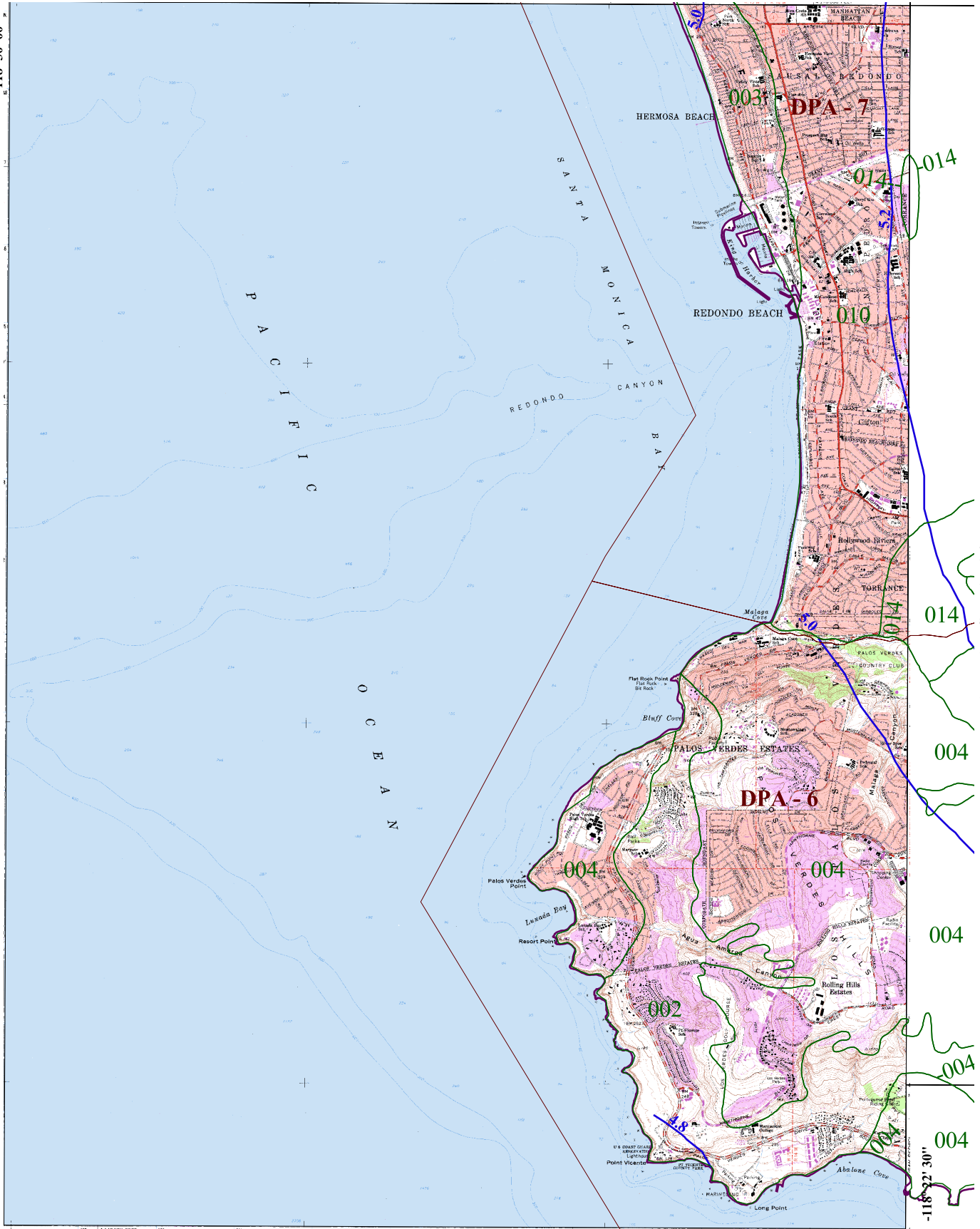

33° 44' 00"



016

SOIL CLASSIFICATION AREA

7.2

INCHES OF RAINFALL

DPA - 6

DEBRIS POTENTIAL AREA

1 0 1 2 Miles

25-YEAR 24-HOUR ISOHYET REDUCTION FACTOR: 0.878
10-YEAR 24-HOUR ISOHYET REDUCTION FACTOR: 0.714

REDONDO BEACH 50-YEAR 24-HOUR ISOHYET

1-HI.3



33° 52' 30"

INGLEWOOD 1-H1.8

-118° 22' 30"

REDONDO BEACH 1-H1.3

LONG BEACH 1-H1.5

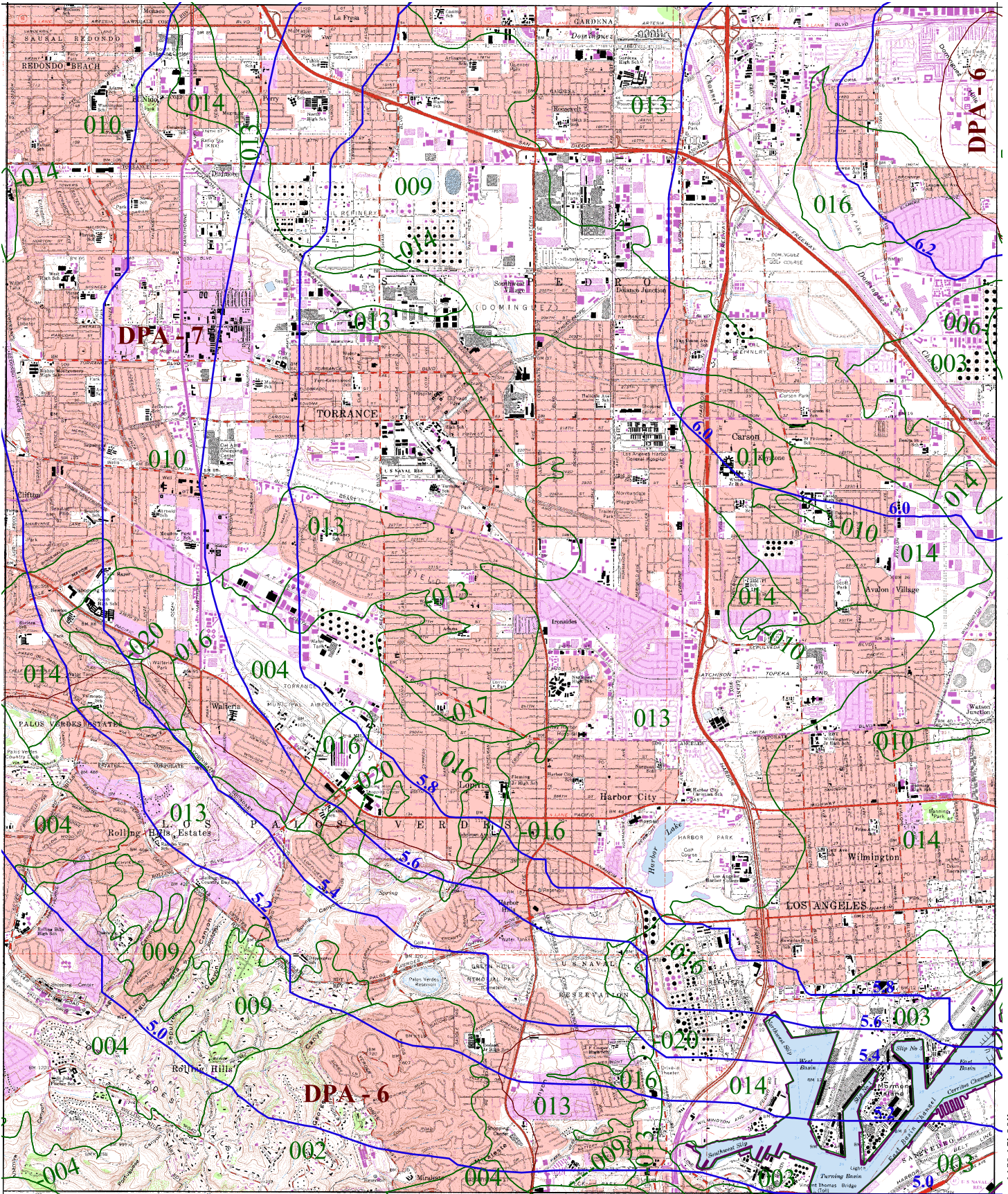

-118° 15' 00"

SAN PEDRO 1-H1.2

33° 45' 00"



016 SOIL CLASSIFICATION AREA

7.2 INCHES OF RAINFALL

DPA - 6 DEBRIS POTENTIAL AREA

1 0 1 2 Miles

25-YEAR 24-HOUR ISOHYET REDUCTION FACTOR: 0.878
 10-YEAR 24-HOUR ISOHYET REDUCTION FACTOR: 0.714

TORRANCE 50-YEAR 24-HOUR ISOHYET

1-H1.4



33° 52' 30"

SOUTH GATE 1-H1.9

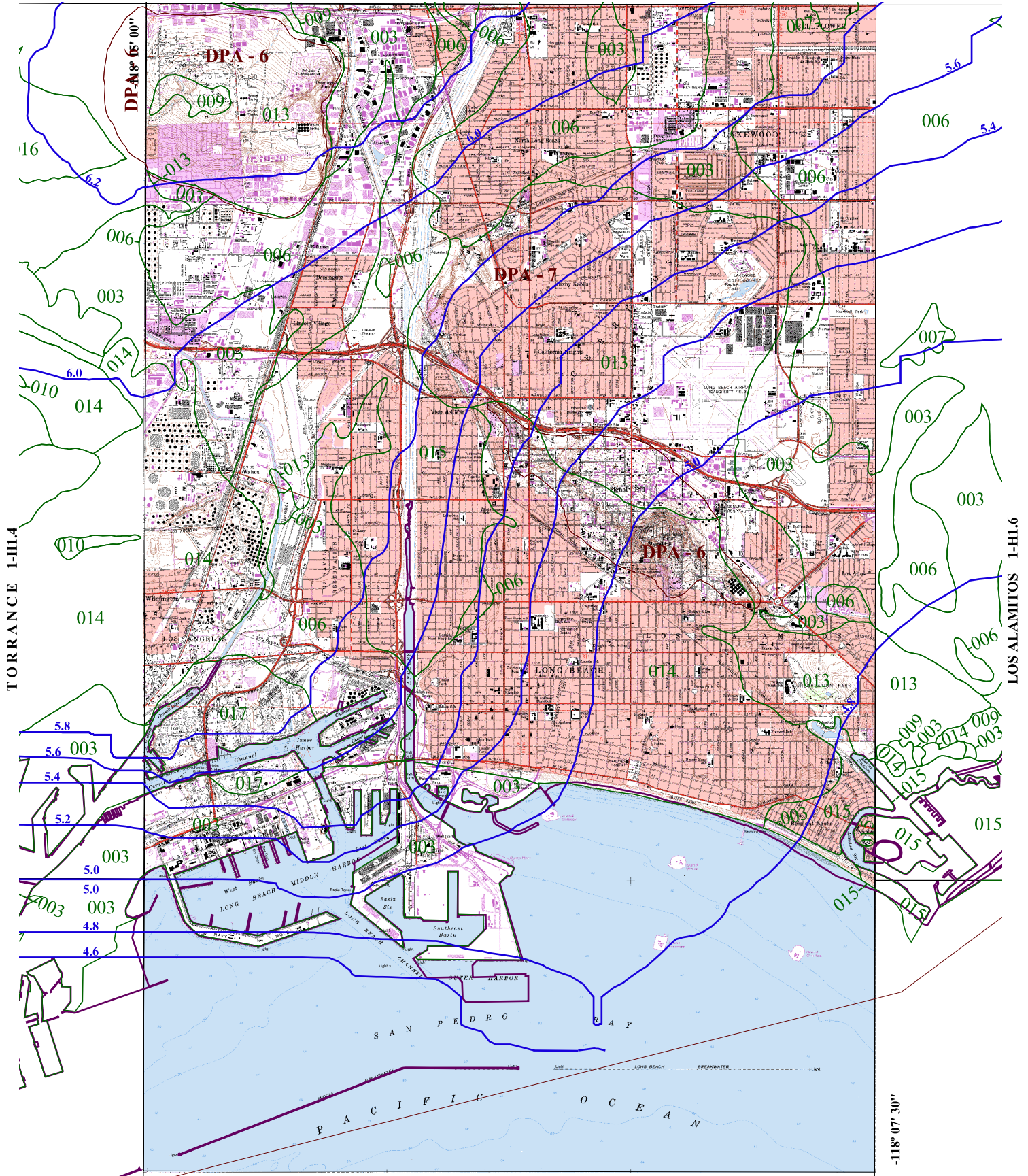

TORRANCE 1-H1.4

LOS ALAMITOS 1-H1.6

33° 43' 30"

-118° 07' 30"



016 SOIL CLASSIFICATION AREA

7.2 INCHES OF RAINFALL

DPA - 6 DEBRIS POTENTIAL AREA

1 0 1 2 Miles

25-YEAR 24-HOUR ISOHYET REDUCTION FACTOR: 0.878
 10-YEAR 24-HOUR ISOHYET REDUCTION FACTOR: 0.714

LONG BEACH 50-YEAR 24-HOUR ISOHYET

1-H1.5



33° 52' 30"

WHITTIER 1-H1.10

-118° 07' 30"

LONG BEACH 1-H1.5

ANAHEIM

-118° 00' 00"

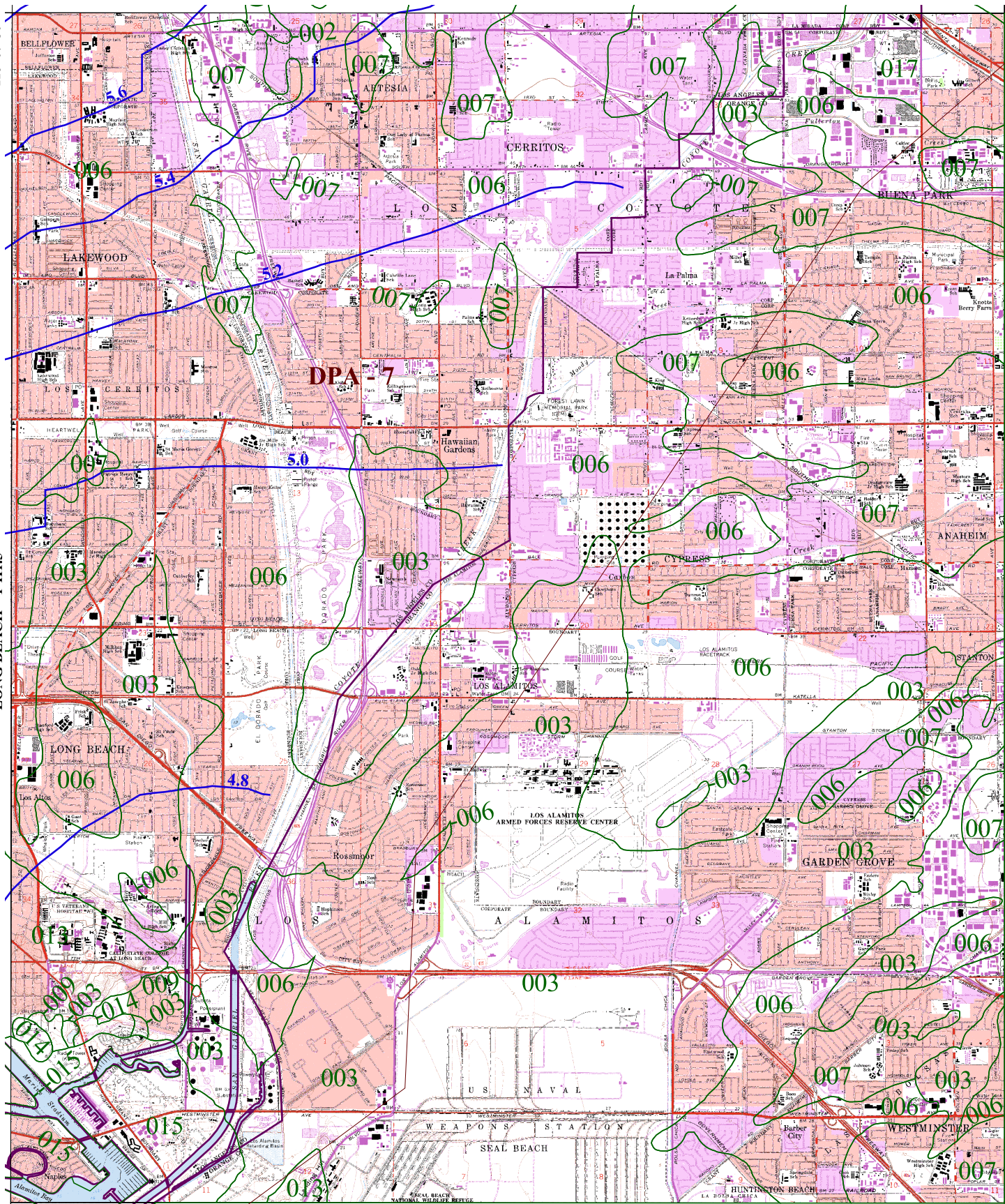

SEAL BEACH

33° 45' 00"



016 SOIL CLASSIFICATION AREA

7.2 INCHES OF RAINFALL

DPA - 6 DEBRIS POTENTIAL AREA

1 0 1 2 Miles

25-YEAR 24-HOUR ISOHYET REDUCTION FACTOR: 0.878
 10-YEAR 24-HOUR ISOHYET REDUCTION FACTOR: 0.714

LOS ALAMITOS 50-YEAR 24-HOUR ISOHYET

1-H1.6



34° 00' 00"

BEVERLY HILLS 1-H1.7

-118° 30' 00"

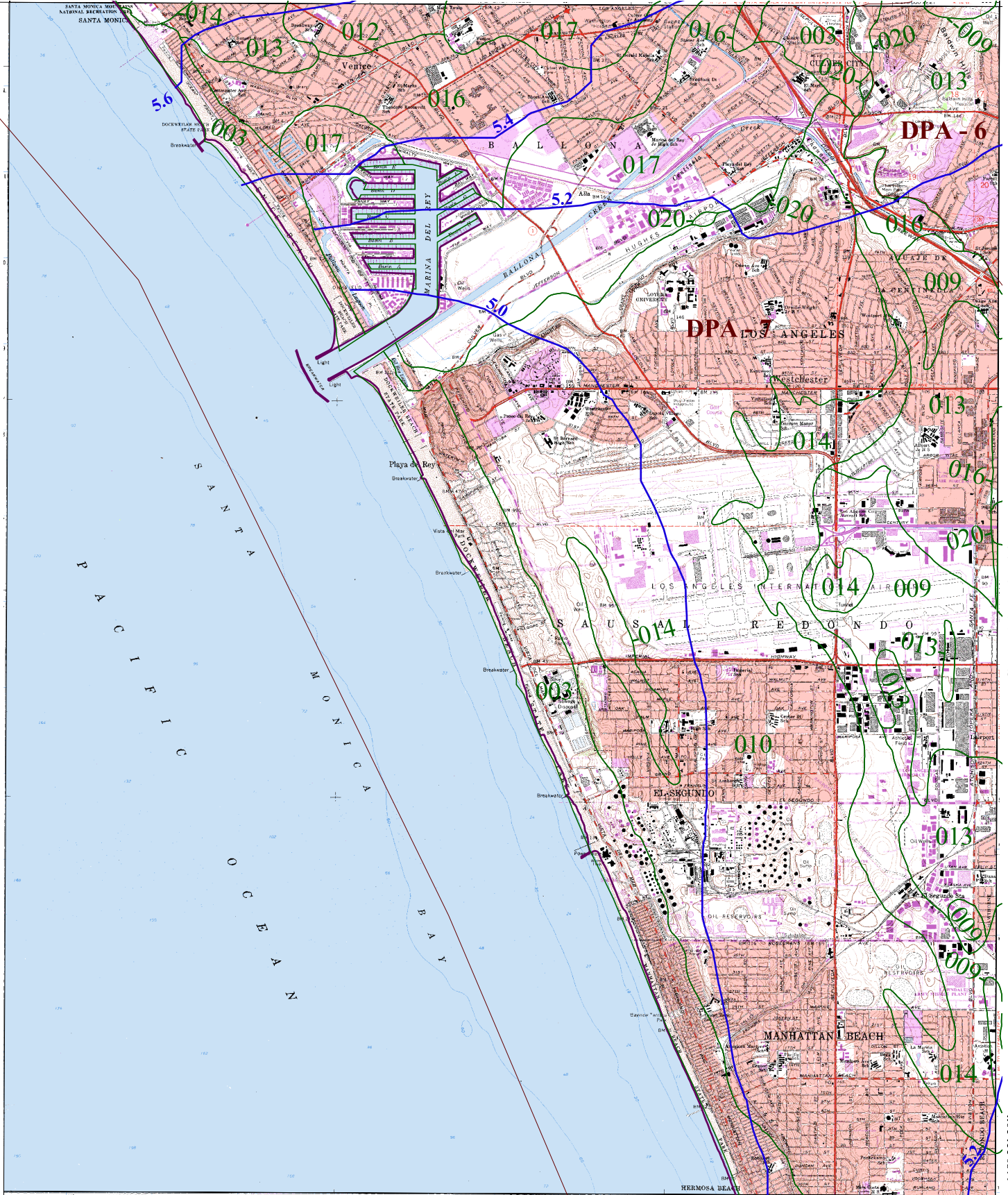

REDONDO BEACH 1-H1.3

33° 52' 30"

INGLEWOOD 1-H1.8

-118° 22' 30"



016

SOIL CLASSIFICATION AREA

7.2

INCHES OF RAINFALL

DPA - 6

DEBRIS POTENTIAL AREA

1 0 1 2 Miles

25-YEAR 24-HOUR ISOHYET REDUCTION FACTOR: 0.878
10-YEAR 24-HOUR ISOHYET REDUCTION FACTOR: 0.714

V E N I C E

50-YEAR 24-HOUR ISOHYET

1-H1.7



34° 00' 00"

HOLLYWOOD 1-H1.18

-118° 22' 30"

VENICE 1-H1.7

SOUTH GATE 1-H1.9

-118° 15' 00"

TORRANCE 1-H1.4

33° 52' 30"



016 SOIL CLASSIFICATION AREA

7.2 INCHES OF RAINFALL

DPA - 6 DEBRIS POTENTIAL AREA

1 0 1 2 Miles

25-YEAR 24-HOUR ISOHYET REDUCTION FACTOR: 0.878
10-YEAR 24-HOUR ISOHYET REDUCTION FACTOR: 0.714

INGLEWOOD 50-YEAR 24-HOUR ISOHYET

1-H1.8

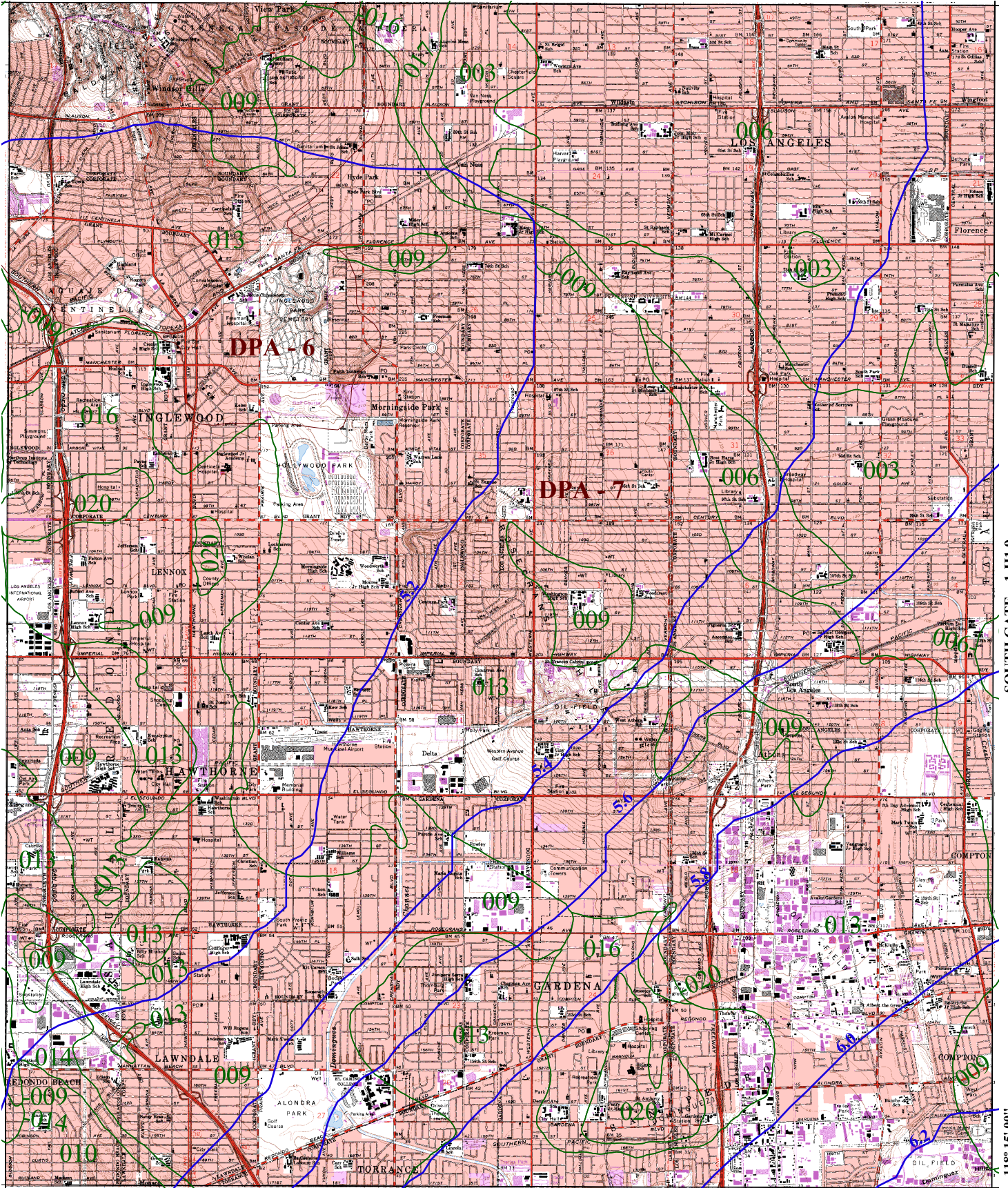

34° 00' 00"

LOS ANGELES 1-HI.19

-118° 15' 00"

INGLEWOOD 1-HI.8

WHITTIER 1-HI.10

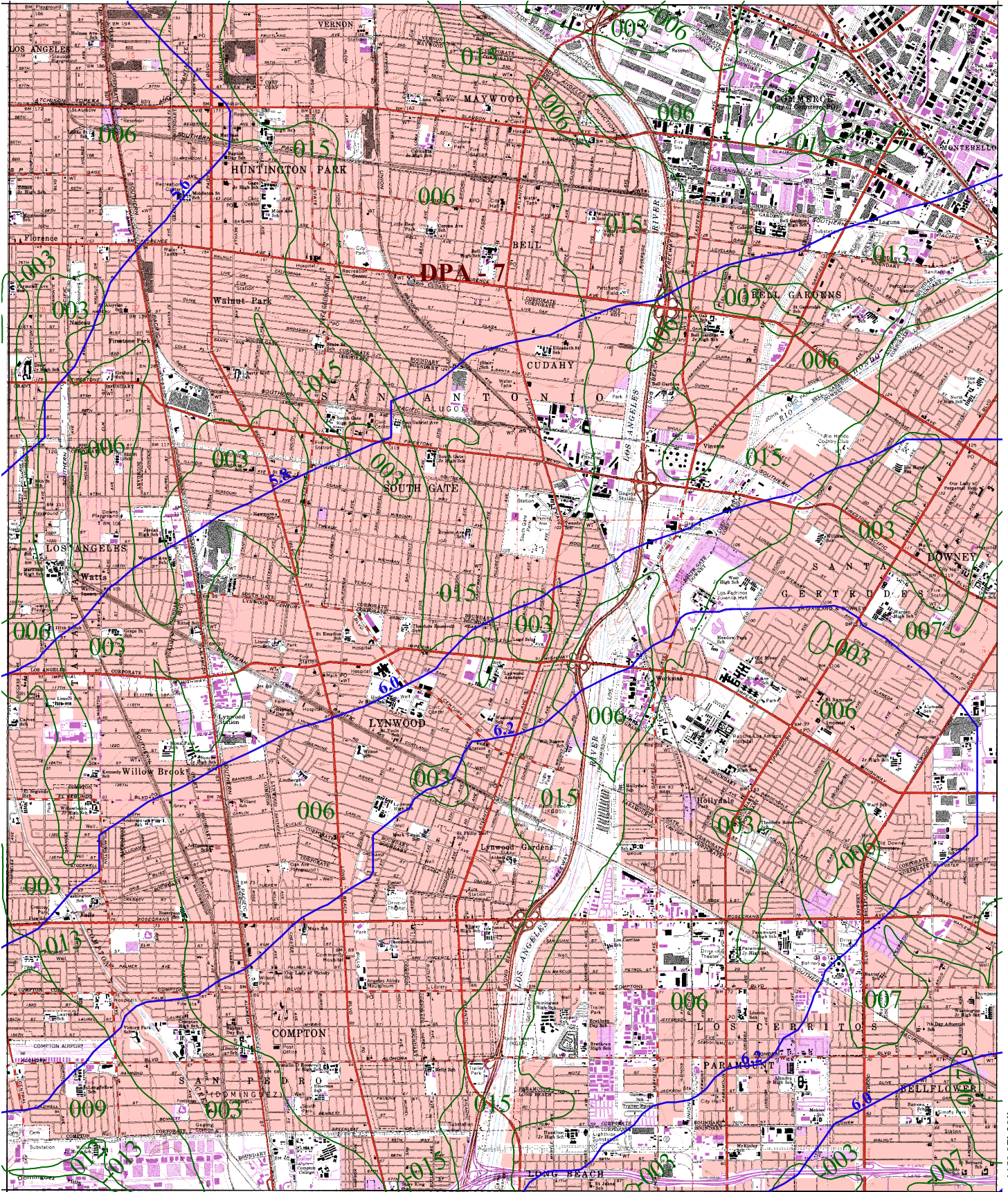

-118° 07' 30"

LONG BEACH 1-HI.5

33° 52' 30"



016 SOIL CLASSIFICATION AREA

7.2 INCHES OF RAINFALL

DPA - 6 DEBRIS POTENTIAL AREA

1 0 1 2 Miles

25-YEAR 24-HOUR ISOHYET REDUCTION FACTOR: 0.878
 10-YEAR 24-HOUR ISOHYET REDUCTION FACTOR: 0.714

SOUTH GATE 50-YEAR 24-HOUR ISOHYET

1-HI.9



34° 00' 00"

EL MONTE 1-HI.20

-118° 07' 30"

SOUTH GATE 1-HI.9

LA HABRA 1-HI.11

-118° 00' 00"

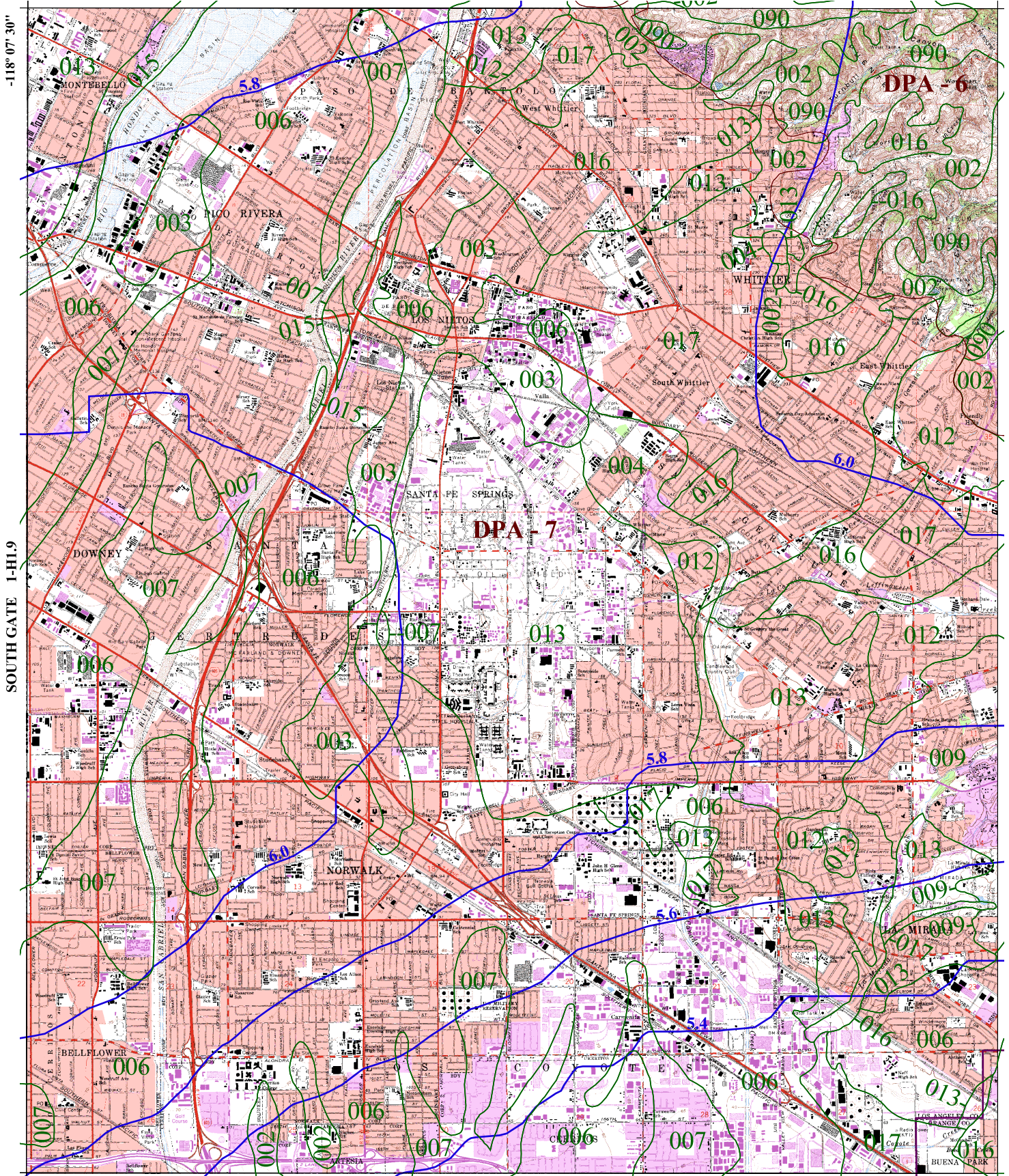

LOS ALAMITOS 1-HI.6

33° 52' 30"



- 016 SOIL CLASSIFICATION AREA
- 7.2 INCHES OF RAINFALL
- DPA - 6 DEBRIS POTENTIAL AREA

1 0 1 2 Miles

25-YEAR 24-HOUR ISOHYET REDUCTION FACTOR: 0.878
 10-YEAR 24-HOUR ISOHYET REDUCTION FACTOR: 0.714

WHITTIER

50-YEAR 24-HOUR ISOHYET

1-HI.10



34° 00' 00"

BALDWIN PARK 1-HI.21

-118° 00' 00"

WHITTIER 1-HI.10

YORBA LINDA 1-HI.12

-117° 52' 30"

ANAHEIM

33° 52' 30"



016 SOIL CLASSIFICATION AREA

7.2 INCHES OF RAINFALL

DPA - 6 DEBRIS POTENTIAL AREA

1 0 1 2 Miles

25-YEAR 24-HOUR ISOHYET REDUCTION FACTOR: 0.878
10-YEAR 24-HOUR ISOHYET REDUCTION FACTOR: 0.714

LA HABRA 50-YEAR 24-HOUR ISOHYET

1-HI.11

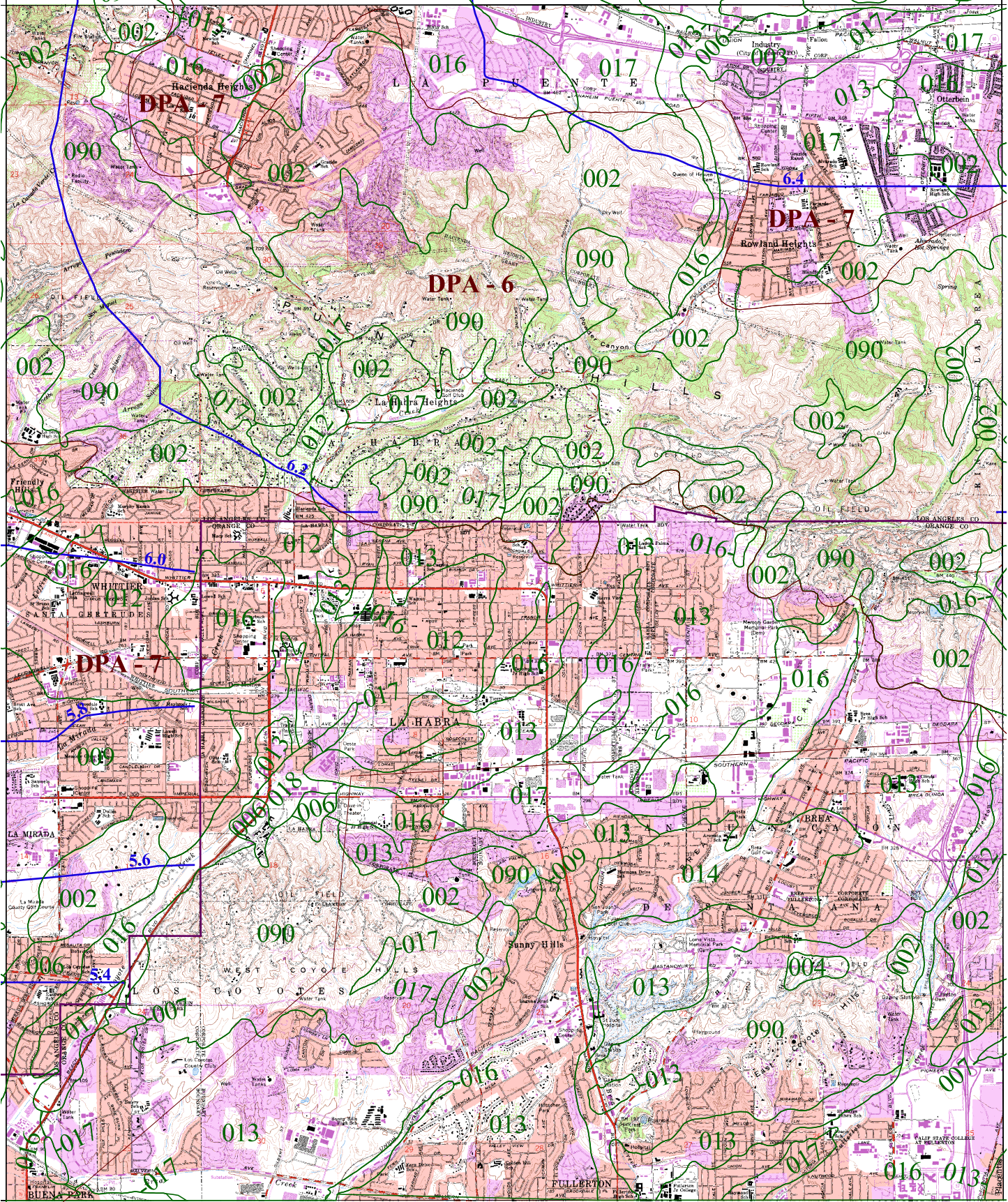

34° 00' 00"

SAN DIMAS 1-H1.22

-117° 52' 30"

LA HABRA 1-H1.11

PRADO DAM

-117° 45' 00"

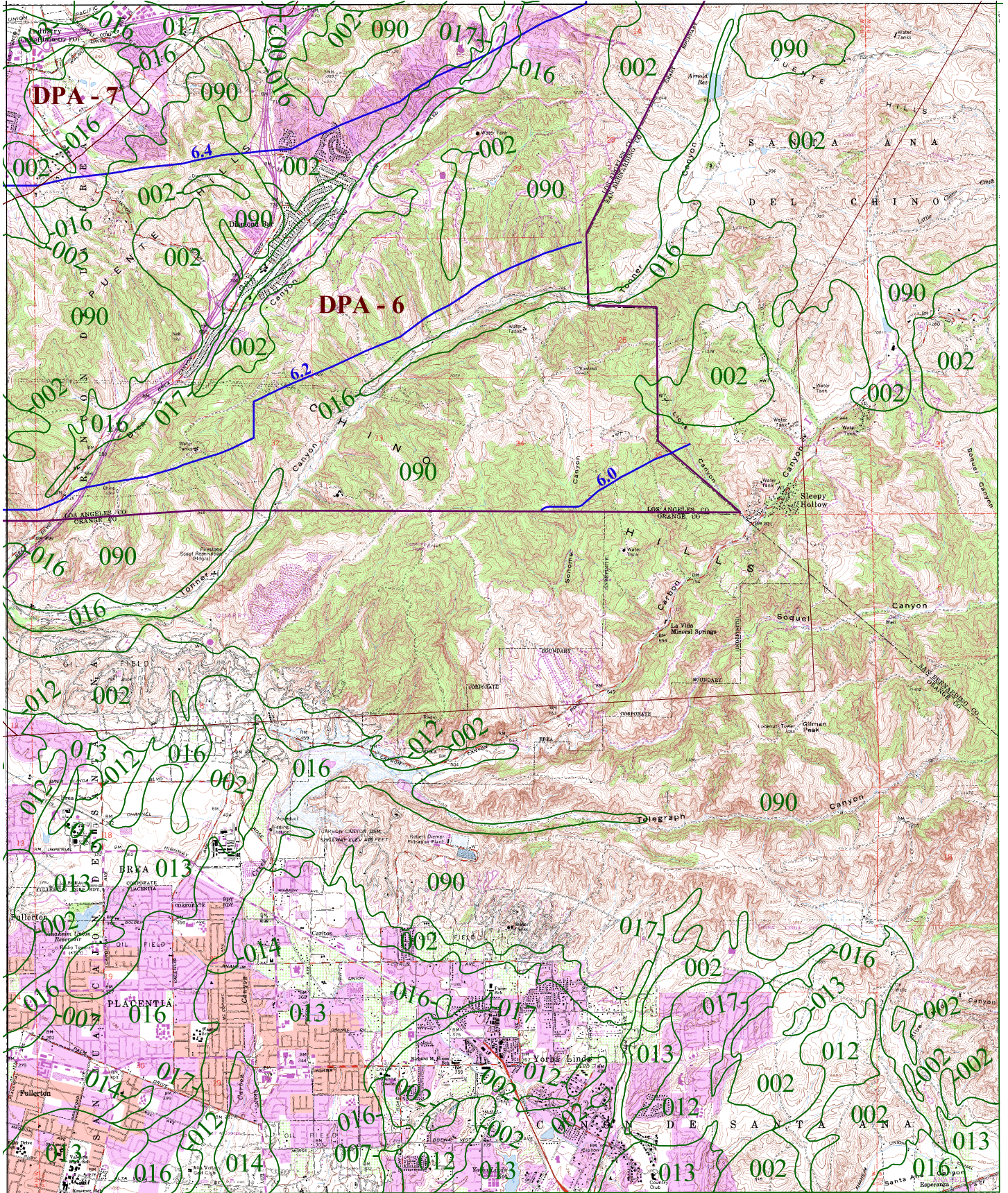

ORANGE

33° 52' 30"



016 SOIL CLASSIFICATION AREA

7.2 INCHES OF RAINFALL

DPA - 6 DEBRIS POTENTIAL AREA

1 0 1 2 Miles

25-YEAR 24-HOUR ISOHYET REDUCTION FACTOR: 0.878
 10-YEAR 24-HOUR ISOHYET REDUCTION FACTOR: 0.714

YORBA LINDA 50-YEAR 24-HOUR ISOHYET

1-H1.12



34° 07' 30"

NEWBURY PARK 1-HI.24A

-119° 00' 00"

POINT MUGU

POINT DUME 1-HI.14

-118° 52' 30"

34° 00' 00"

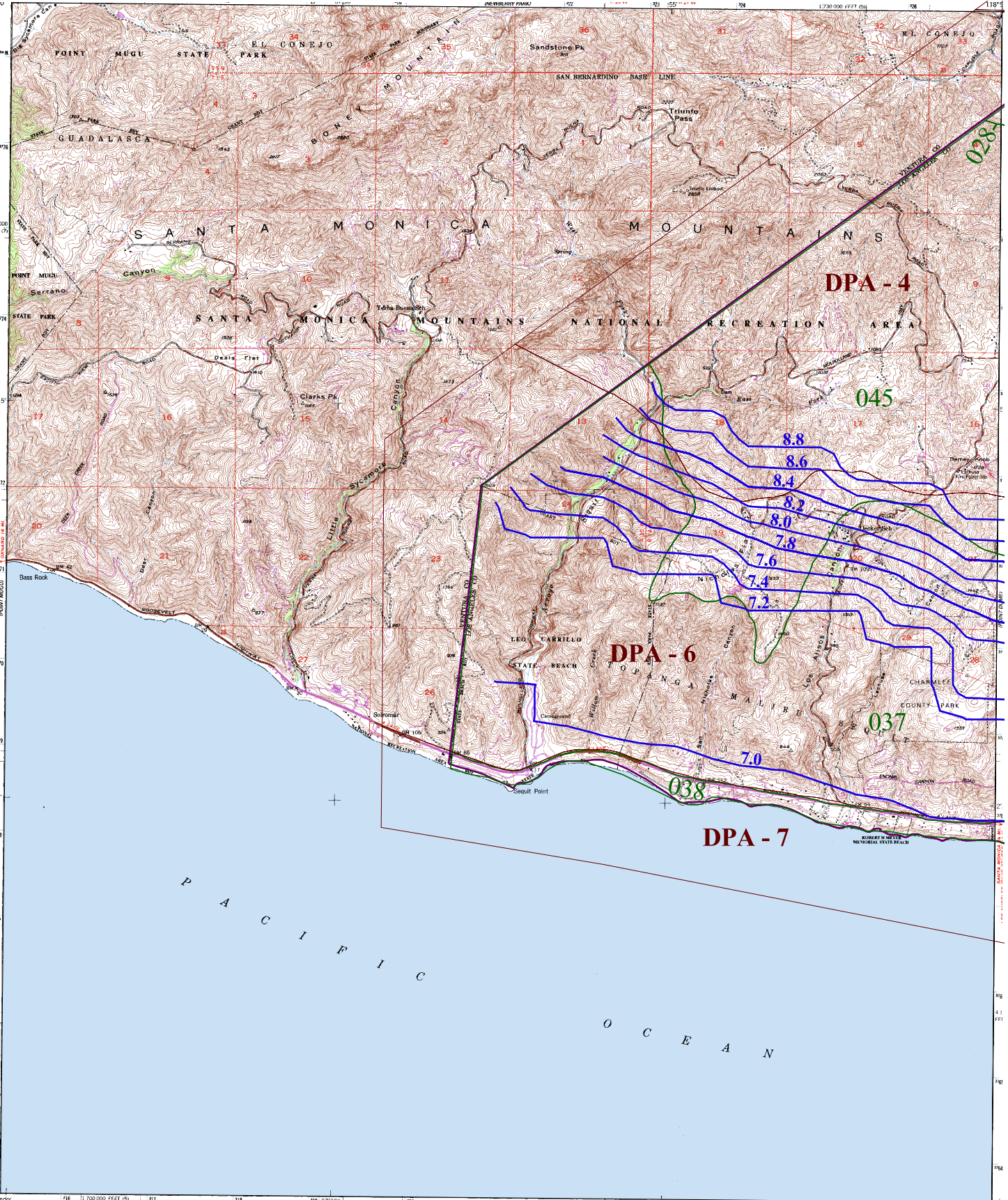

016

SOIL CLASSIFICATION AREA

7.2

INCHES OF RAINFALL

DPA - 6

DEBRIS POTENTIAL AREA

1 0 1 2 Miles

25-YEAR 24-HOUR ISOHYET REDUCTION FACTOR: 0.878
10-YEAR 24-HOUR ISOHYET REDUCTION FACTOR: 0.714

TRIUNFO PASS 50-YEAR 24-HOUR ISOHYET

1-HI.13



34° 07' 30"

THOUSAND OAKS 1-H1.24

-118° 52' 30"

TRIUNFO PASS 1-H1.13

MALIBU BEACH 1-H1.15

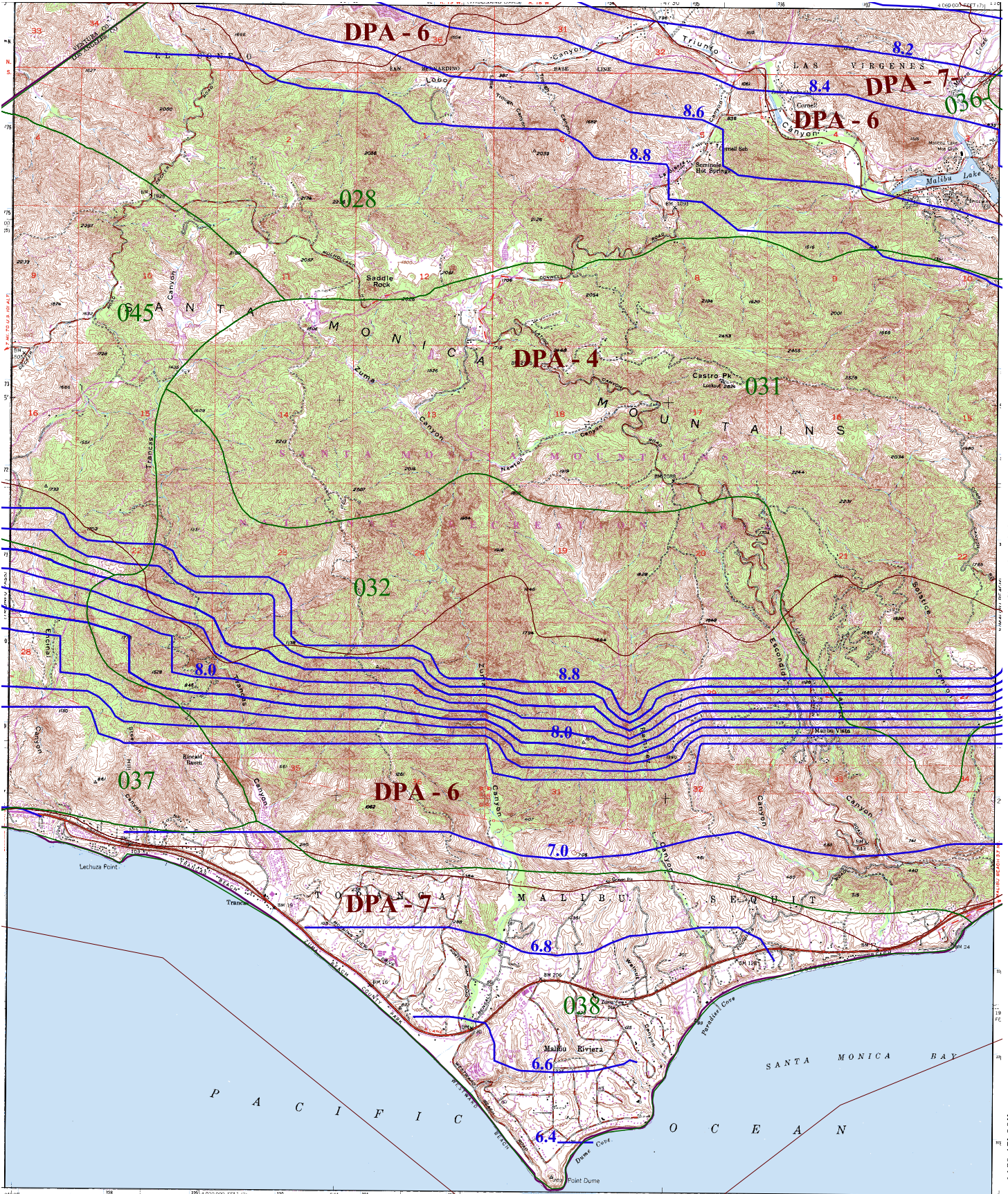

-118° 45' 00"

34° 00' 00"



016

SOIL CLASSIFICATION AREA

7.2

INCHES OF RAINFALL

DPA - 6

DEBRIS POTENTIAL AREA

1 0 1 2 Miles

25-YEAR 24-HOUR ISOHYET REDUCTION FACTOR: 0.878

10-YEAR 24-HOUR ISOHYET REDUCTION FACTOR: 0.714

POINT DUME

50-YEAR 24-HOUR ISOHYET

1-H1.14



34° 07' 30"

CALABASAS I-HI.25

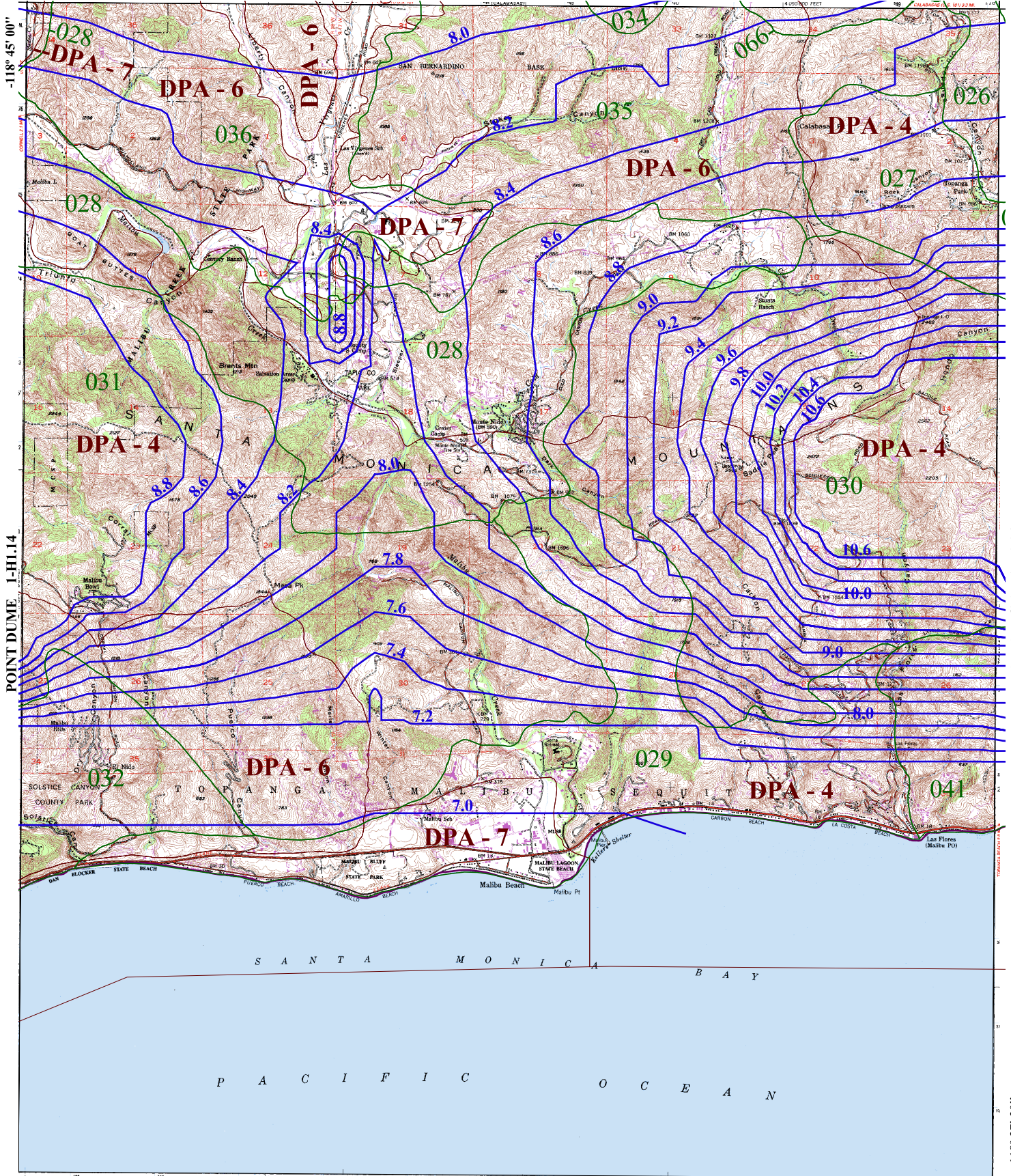

POINT DUME I-HI.14

TOPANGA I-HI.16

34° 00' 00"

-118° 37' 30"



016

SOIL CLASSIFICATION AREA

7.2

INCHES OF RAINFALL

DPA - 6

DEBRIS POTENTIAL AREA

1 0 1 2 Miles

25-YEAR 24-HOUR ISOHYET REDUCTION FACTOR: 0.878

10-YEAR 24-HOUR ISOHYET REDUCTION FACTOR: 0.714

MALIBU BEACH

50-YEAR 24-HOUR ISOHYET

1-HI.15



34° 07' 30"

CANOGA PARK 1-HI.26

-118° 37' 30"

MALIBU BEACH 1-HI.15

BEVERLY HILLS 1-HI.17

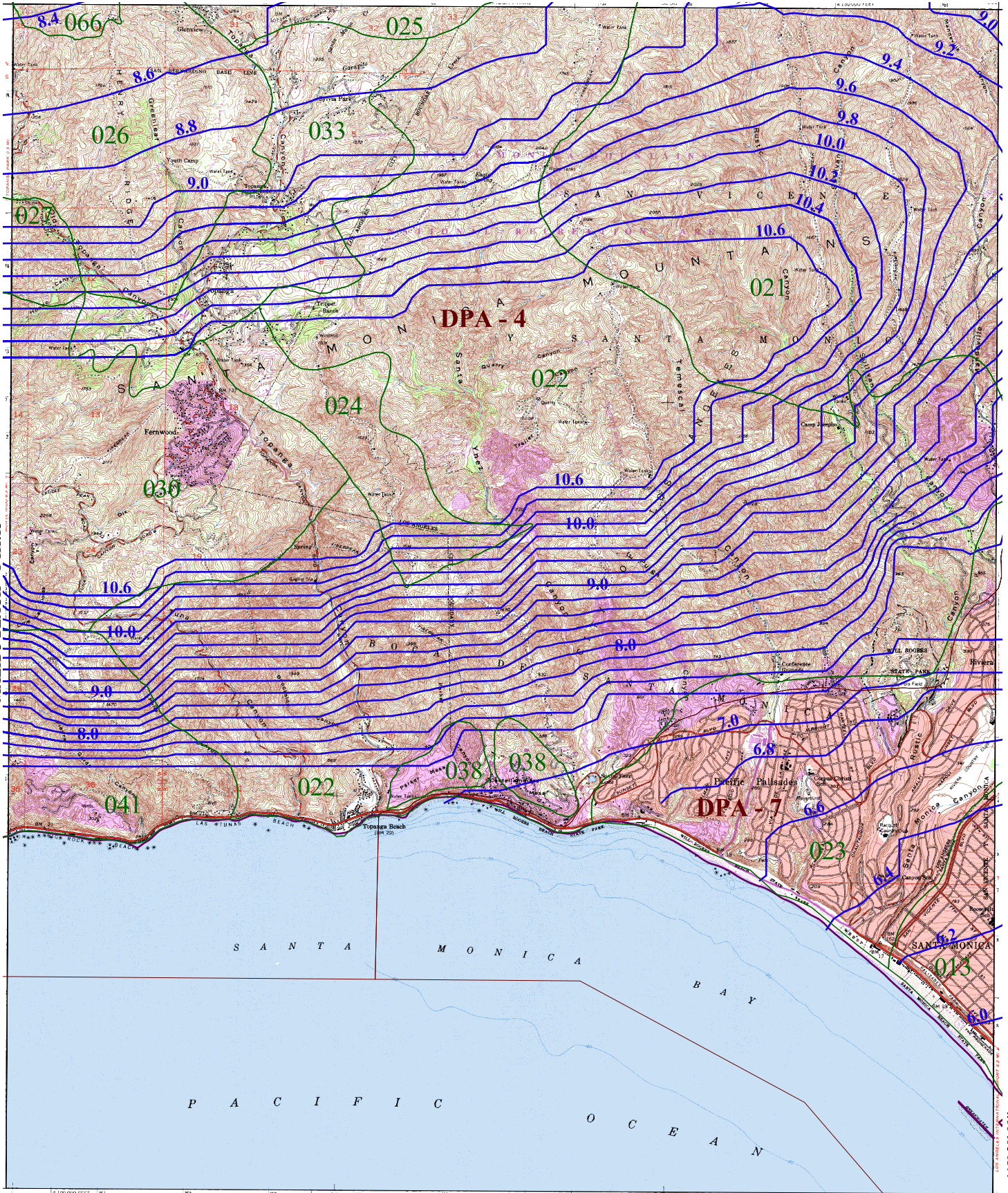

-118° 30' 00"

34° 00' 00"



016

SOIL CLASSIFICATION AREA

7.2

INCHES OF RAINFALL

DPA - 6

DEBRIS POTENTIAL AREA

1 0 1 2 Miles

25-YEAR 24-HOUR ISOHYET REDUCTION FACTOR: 0.878
10-YEAR 24-HOUR ISOHYET REDUCTION FACTOR: 0.714

TOPANGA 50-YEAR 24-HOUR ISOHYET

1-HI.16



34° 07' 30"

VAN NUYS 1-HI.27

-118° 30' 00"

TOPANGA 1-HI.16

HOLLYWOOD 1-HI.18

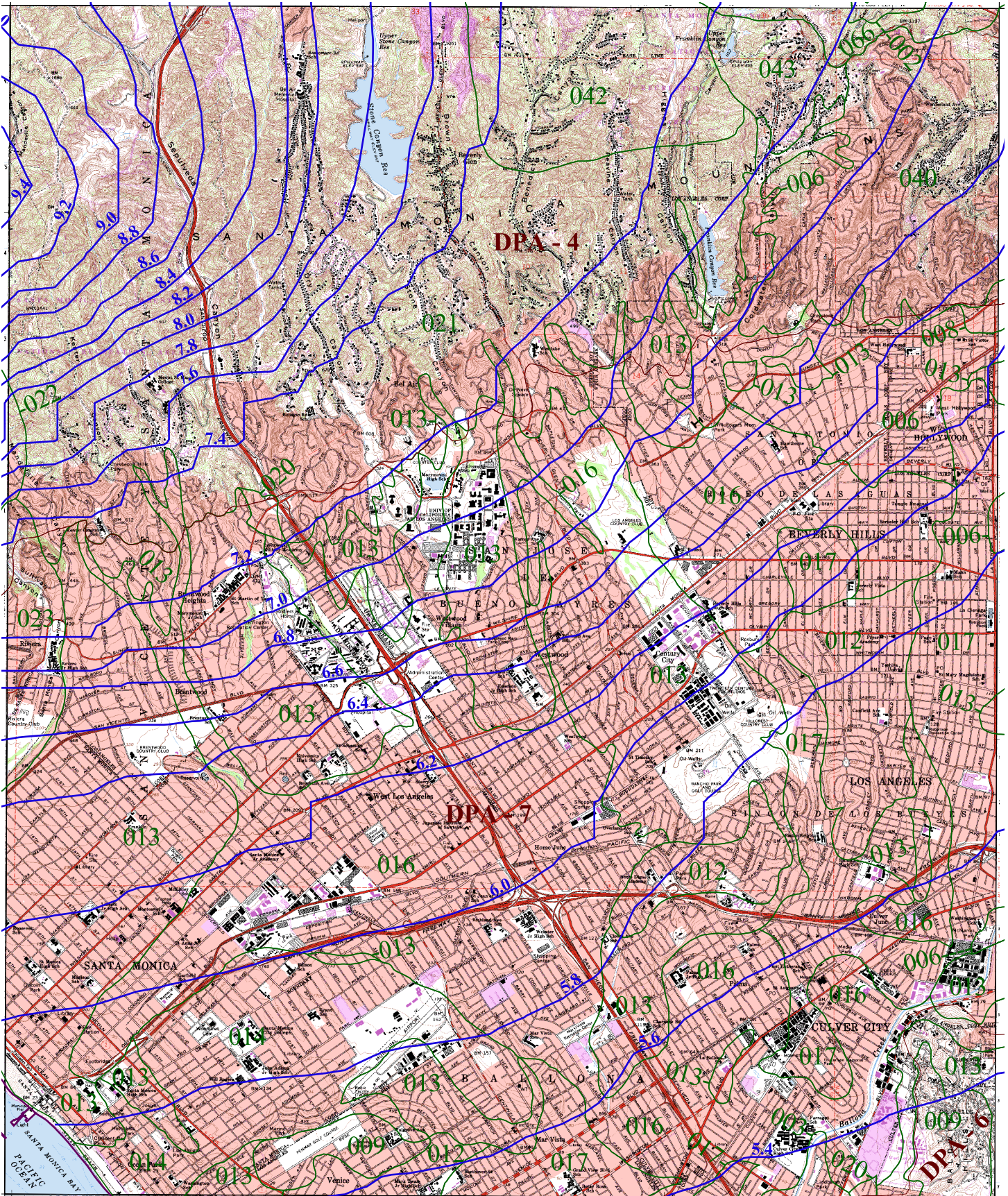

-118° 22' 30"

VENICE 1-HI.7

34° 00' 00"



016

SOIL CLASSIFICATION AREA

7.2

INCHES OF RAINFALL

DPA - 6

DEBRIS POTENTIAL AREA

1 0 1 2 Miles

25-YEAR 24-HOUR ISOHYET REDUCTION FACTOR: 0.878
10-YEAR 24-HOUR ISOHYET REDUCTION FACTOR: 0.714

BEVERLY HILLS 50-YEAR 24-HOUR ISOHYET

1-HI.17



34° 07' 30"

BURBANK 1-H1.28

-118° 22' 30"

BEVERLY HILLS 1-H1.17

LOS ANGELES 1-H1.19

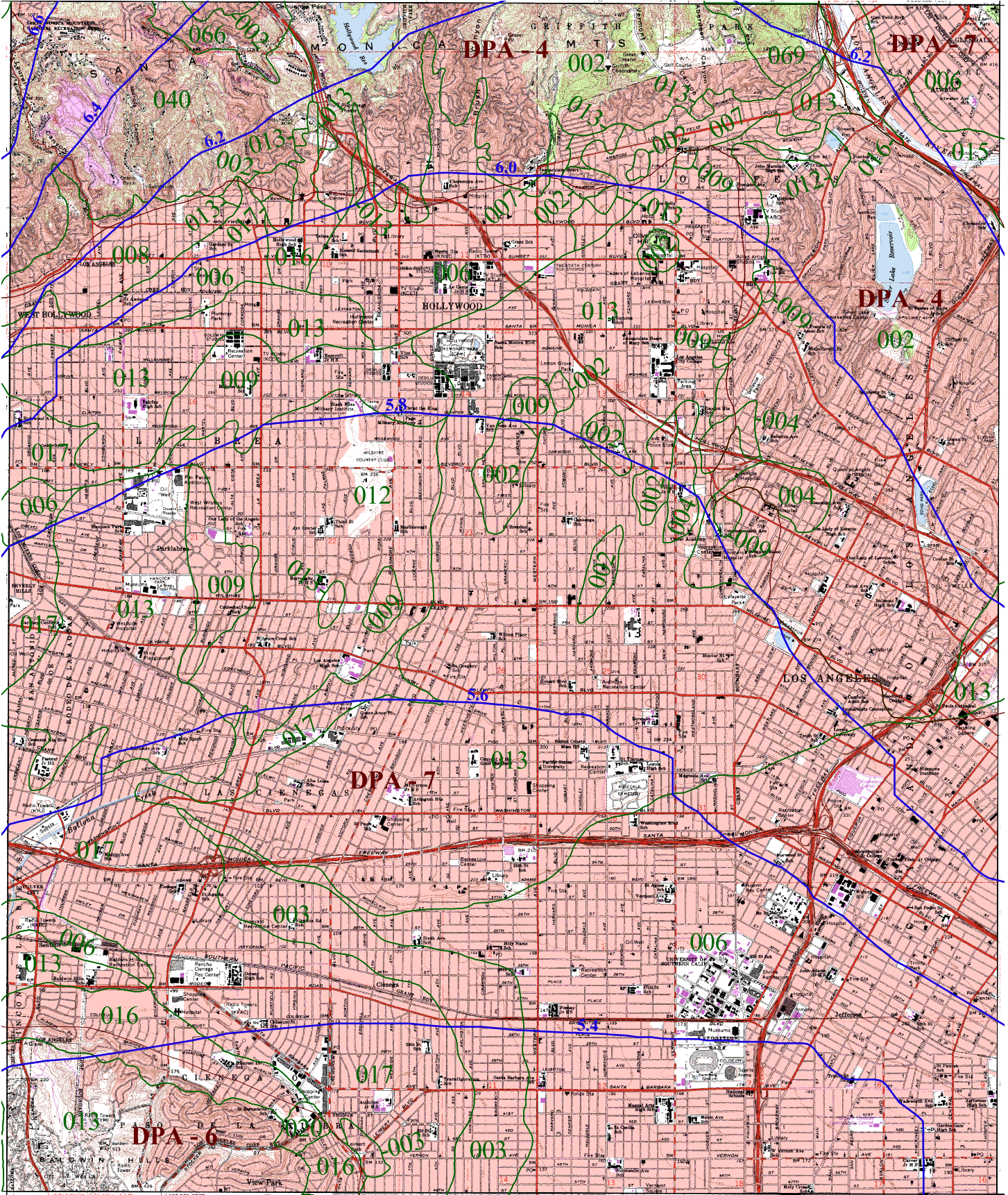

-118° 15' 00"

INGLEWOOD 1-H1.8

34° 00' 00"



016 SOIL CLASSIFICATION AREA

7.2 INCHES OF RAINFALL

DPA - 6 DEBRIS POTENTIAL AREA

1 0 1 2 Miles

25-YEAR 24-HOUR ISOHYET REDUCTION FACTOR: 0.878
 10-YEAR 24-HOUR ISOHYET REDUCTION FACTOR: 0.714

HOLLYWOOD

50-YEAR 24-HOUR ISOHYET

1-H1.18



34° 07' 30"

PASADENA 1-HI.29

-118° 15' 00"

HOLLYWOOD 1-HI.18

EL MONTE 1-HI.20

-118° 07' 30"

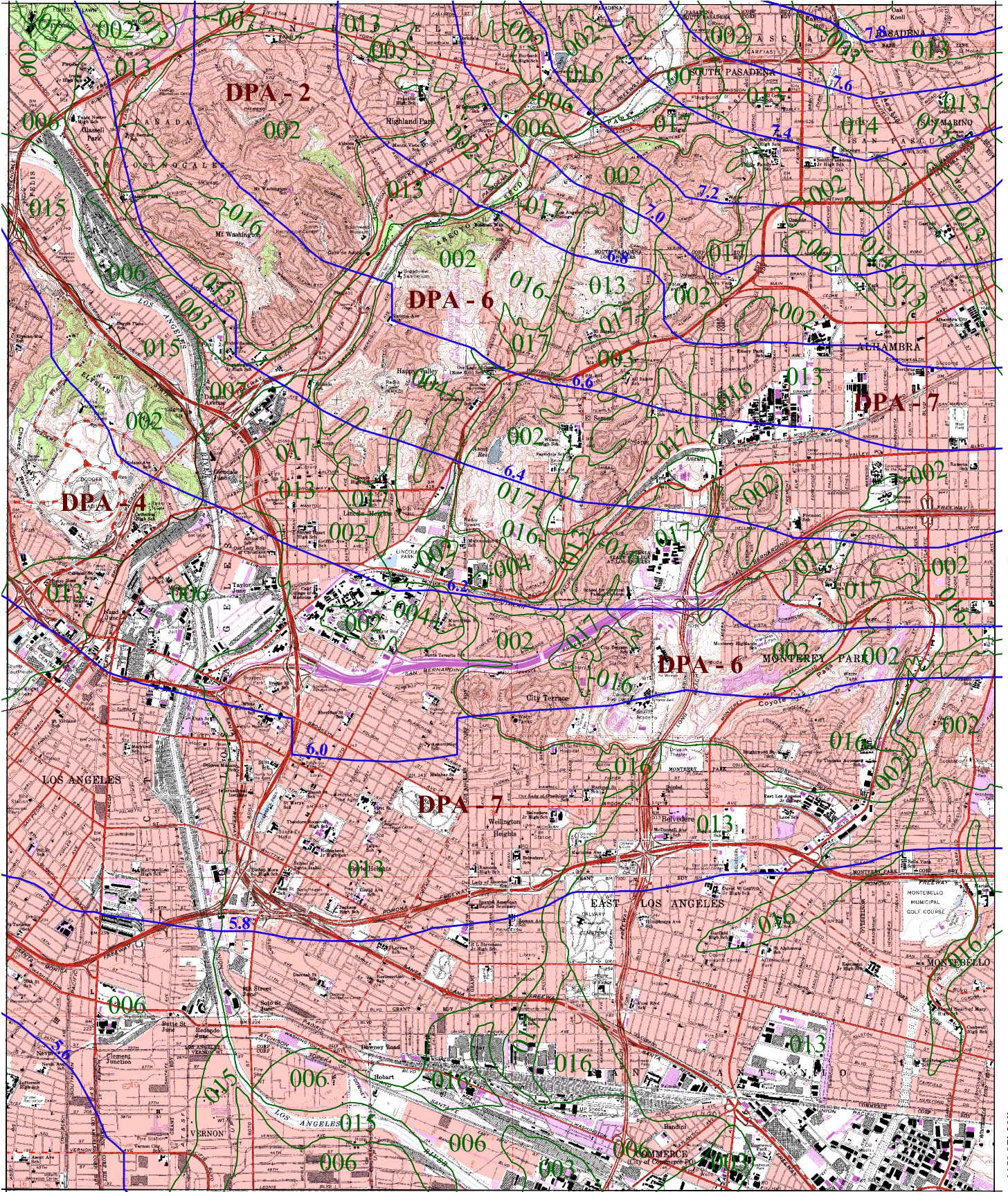

SOUTH GATE 1-HI.9

34° 00' 00"



016

SOIL CLASSIFICATION AREA

7.2

INCHES OF RAINFALL

DPA - 6

DEBRIS POTENTIAL AREA

1 0 1 2 Miles

25-YEAR 24-HOUR ISOHYET REDUCTION FACTOR: 0.878
10-YEAR 24-HOUR ISOHYET REDUCTION FACTOR: 0.714

LOS ANGELES 50-YEAR 24-HOUR ISOHYET

1-HI.19



34° 07' 30"

MOUNT WILSON 1-H1.30

-118° 07' 30"

LOS ANGELES 1-H1.19



016 SOIL CLASSIFICATION AREA

7.2 INCHES OF RAINFALL

DPA - 6 DEBRIS POTENTIAL AREA

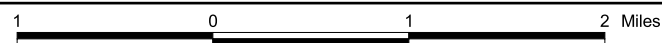

25-YEAR 24-HOUR ISOHYET REDUCTION FACTOR: 0.878
10-YEAR 24-HOUR ISOHYET REDUCTION FACTOR: 0.714

EL MONTE 50-YEAR 24-HOUR ISOHYET

1-H1.20



BALDWIN PARK 1-H1.21

-118° 00' 00"

WHITTIER 1-H1.10

34° 00' 00"

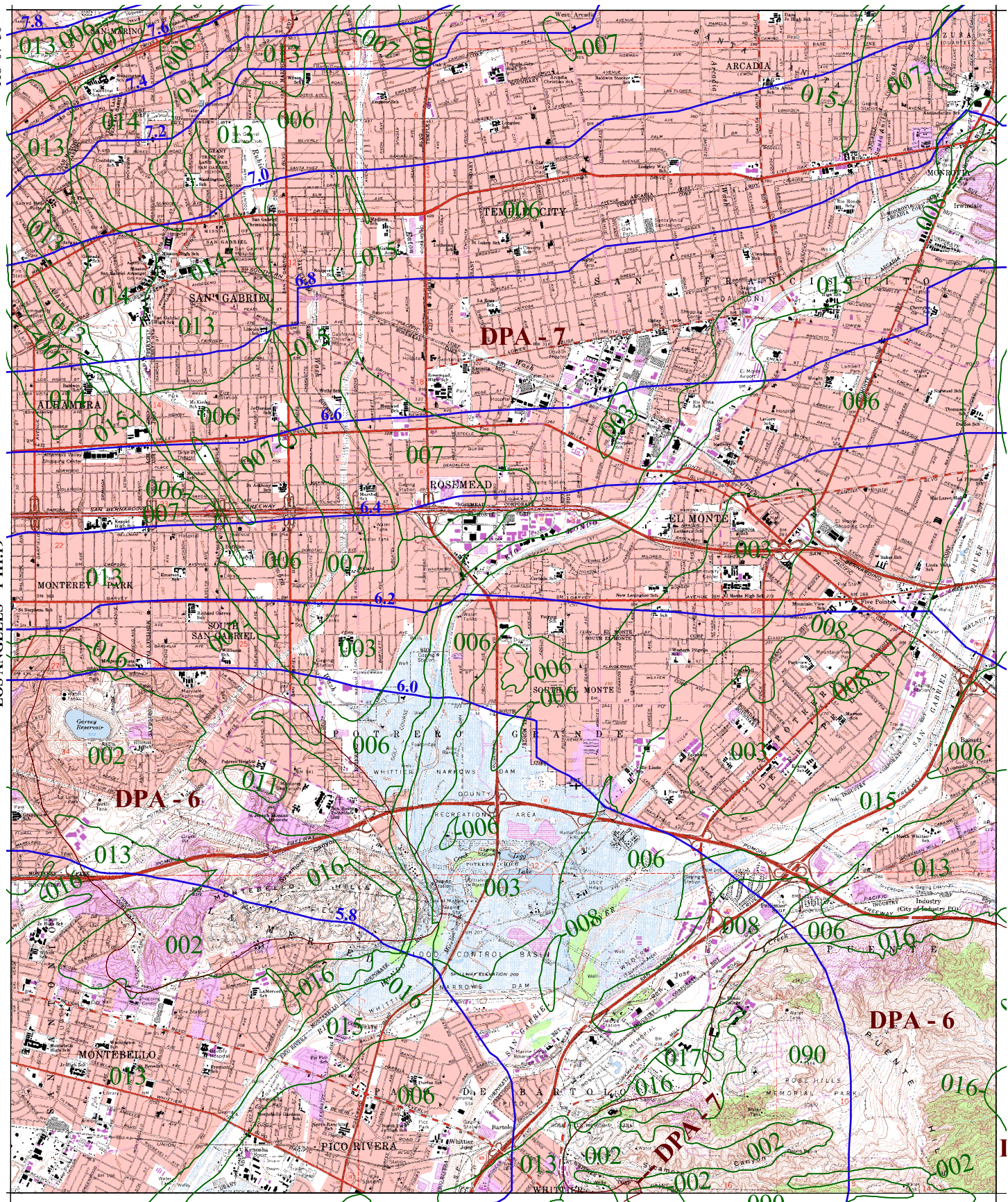

34° 07' 30"

AZUSA 1-HI.31

-118° 00' 00"

EL MONTE 1-HI.20

SAN DIMAS 1-HI.22

-117° 52' 30"

LA HABRA 1-HI.11

34° 00' 00"

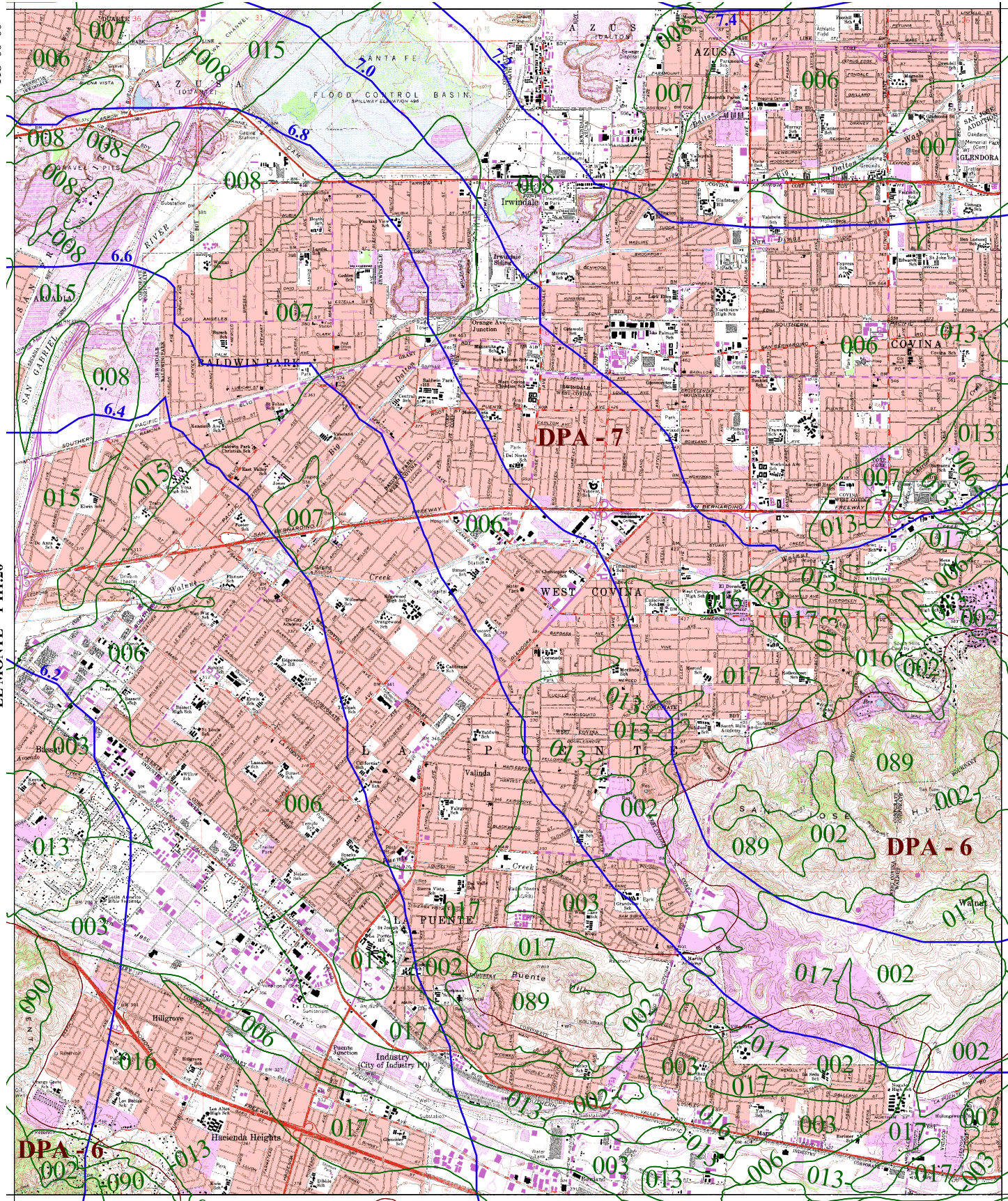

1 0 1 2 Miles

25-YEAR 24-HOUR ISOHYET REDUCTION FACTOR: 0.878
10-YEAR 24-HOUR ISOHYET REDUCTION FACTOR: 0.714

BALDWIN PARK 50-YEAR 24-HOUR ISOHYET

1-HI.21



016 SOIL CLASSIFICATION AREA

7.2 INCHES OF RAINFALL

DPA - 6 DEBRIS POTENTIAL AREA



34° 07' 30"

GLENDORA 1-HI.32

-117° 52' 30"

BALDWIN PARK 1-HI.21

ONTARIO 1-HI.23

-117° 45' 00"

YORBA LINDA 1-HI.12

34° 00' 00"

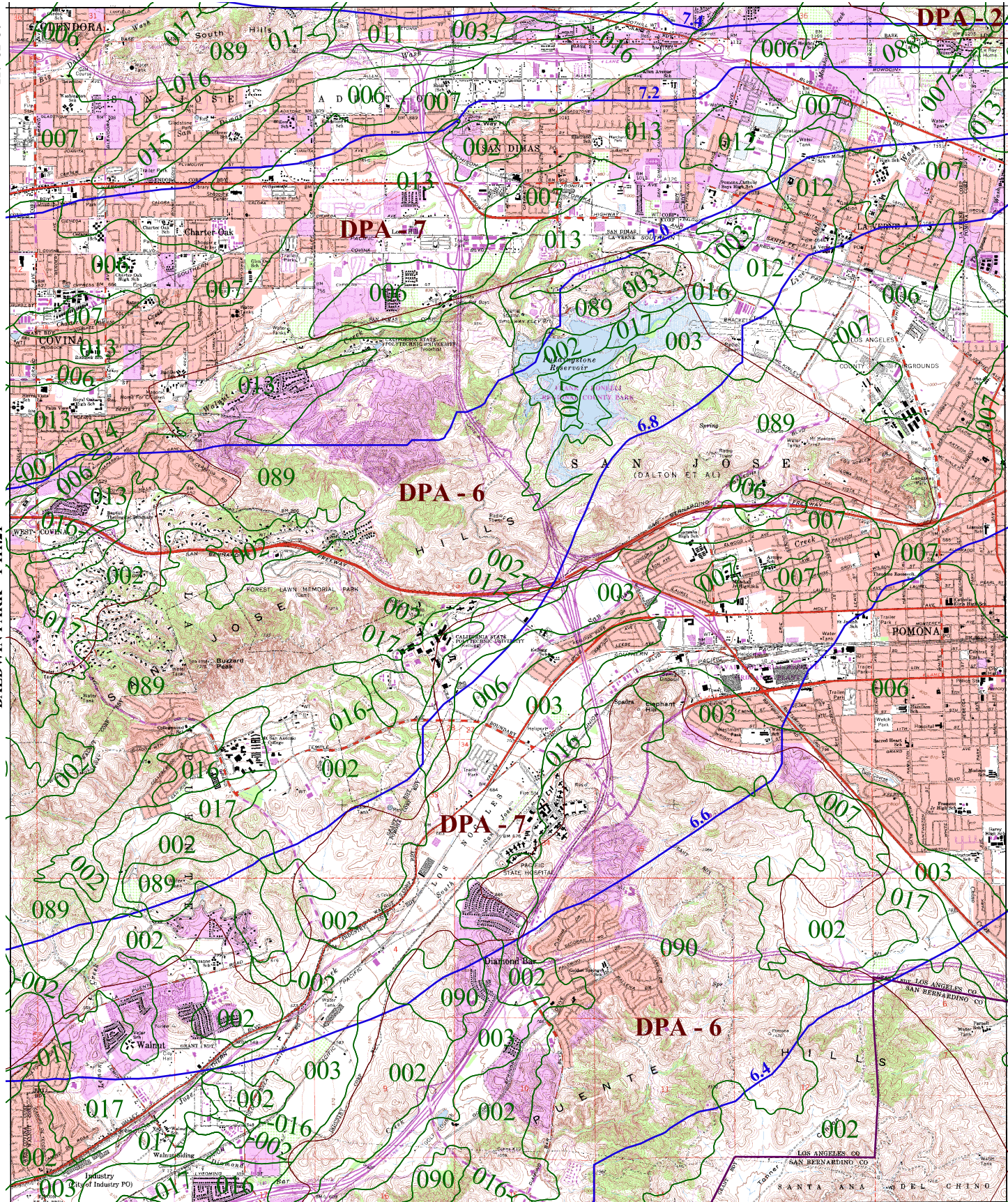

016 SOIL CLASSIFICATION AREA

7.2 INCHES OF RAINFALL

DPA - 6 DEBRIS POTENTIAL AREA

1 0 1 2 Miles

25-YEAR 24-HOUR ISOHYET REDUCTION FACTOR: 0.878
 10-YEAR 24-HOUR ISOHYET REDUCTION FACTOR: 0.714

SAN DIMAS 50-YEAR 24-HOUR ISOHYET

1-HI.22



34° 07' 30"

WHITTIER I-H1.10

-117° 45' 00"

SAN DIMAS I-H1.22

GUASTI

-117° 37' 30"

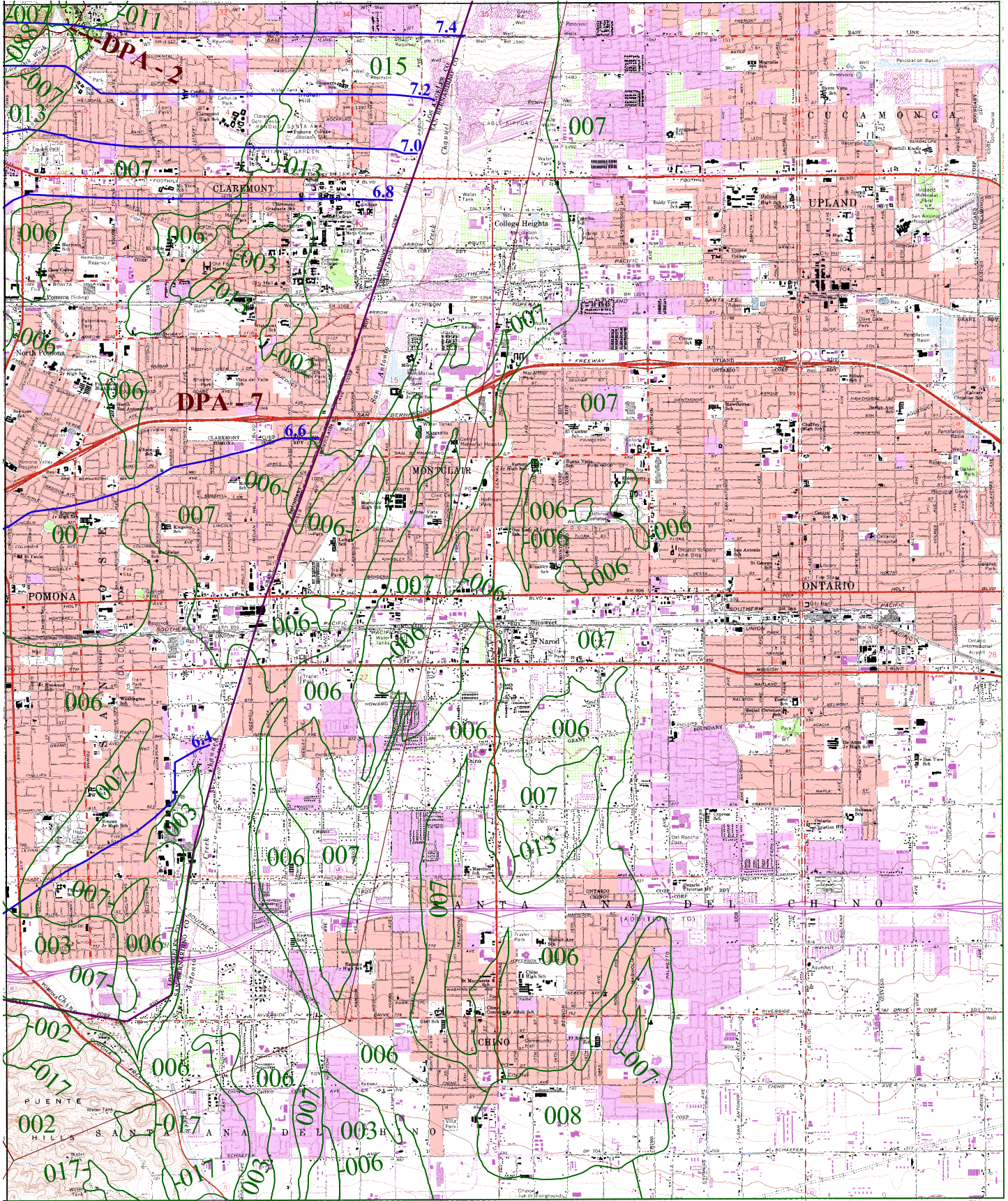

PRADO DAM

34° 00' 00"

1 0 1 2 Miles

25-YEAR 24-HOUR ISOHYET REDUCTION FACTOR: 0.878
10-YEAR 24-HOUR ISOHYET REDUCTION FACTOR: 0.714

ONTARIO 50-YEAR 24-HOUR ISOHYET

1-H1.23



016 SOIL CLASSIFICATION AREA

7.2 INCHES OF RAINFALL

DPA - 6 DEBRIS POTENTIAL AREA



34° 15' 00"

SIMI

-118° 52' 30"

NEWBURY PARK 1-HI.244

CALABASAS 1-HI.25

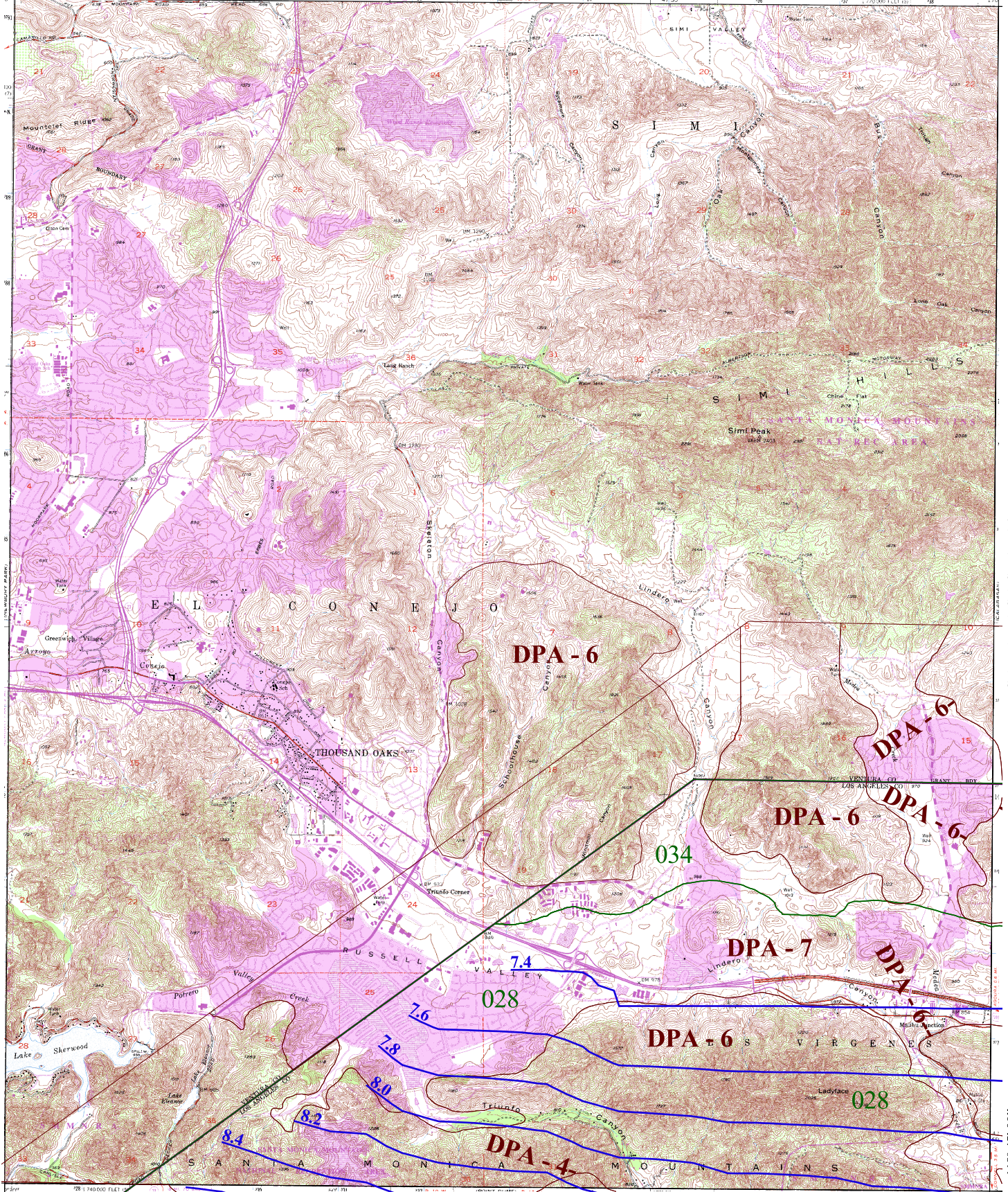

016 SOIL CLASSIFICATION AREA

7.2 INCHES OF RAINFALL

DPA - 6 DEBRIS POTENTIAL AREA

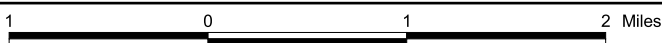

25-YEAR 24-HOUR ISOHYET REDUCTION FACTOR: 0.878
 10-YEAR 24-HOUR ISOHYET REDUCTION FACTOR: 0.714

THOUSAND OAKS 50-YEAR 24-HOUR ISOHYET

1-HI.24



34° 07' 30"

-118° 45' 00"

POINT DUME 1-HI.14

34° 15' 00"

SANTA SUSANA 1-HI.34

-118° 45' 00"

THOUSAND OAKS 1-HI.24

CANOGA PARK 1-HI.26

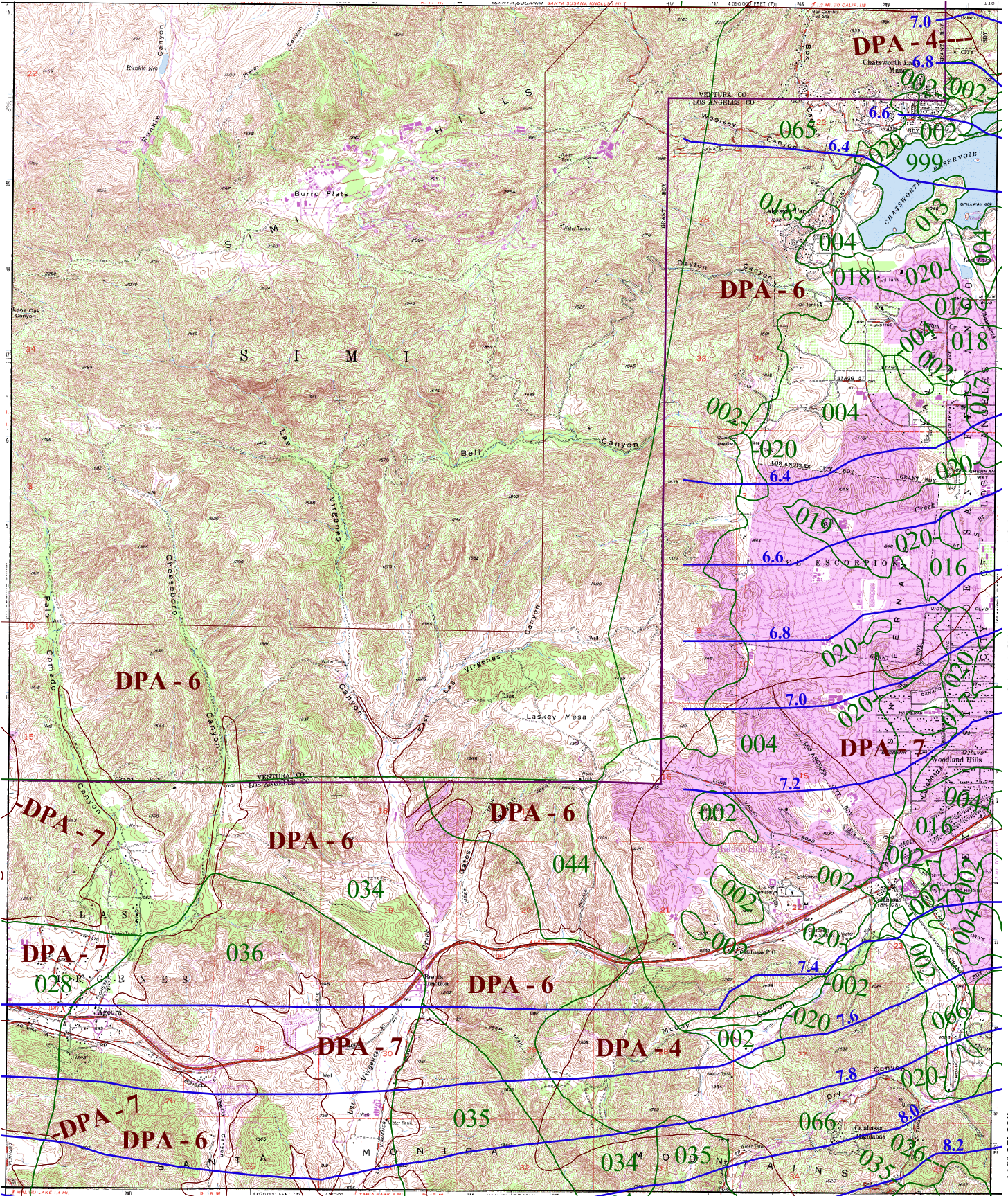

-118° 37' 30"

MALIBU BEACH 1-HI.15

34° 07' 30"



016 SOIL CLASSIFICATION AREA

7.2 INCHES OF RAINFALL

DPA - 6 DEBRIS POTENTIAL AREA

1 0 1 2 Miles

25-YEAR 24-HOUR ISOHYET REDUCTION FACTOR: 0.878
 10-YEAR 24-HOUR ISOHYET REDUCTION FACTOR: 0.714

CALABASAS

50-YEAR 24-HOUR ISOHYET

1-HI.25



34° 15' 00"

OAT MOUNTAIN 1-HI.35

-118° 37' 30"

CALABASAS 1-HI.25

VAN NUYS 1-HI.27

TOPANGA 1-HI.16

34° 07' 30"

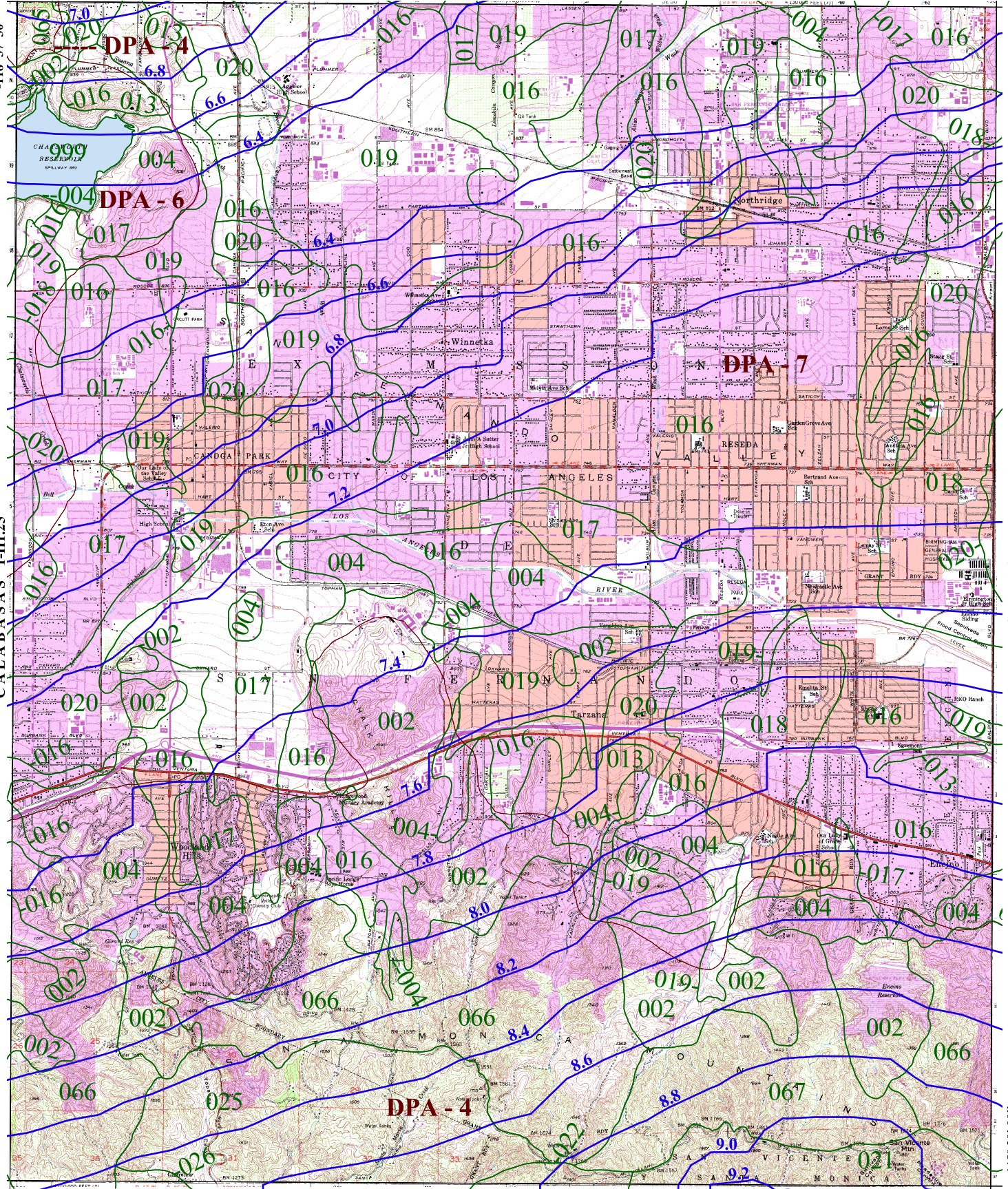

016 SOIL CLASSIFICATION AREA

7.2 INCHES OF RAINFALL

DPA - 6 DEBRIS POTENTIAL AREA

1 0 1 2 Miles

25-YEAR 24-HOUR ISOHYET REDUCTION FACTOR: 0.878
 10-YEAR 24-HOUR ISOHYET REDUCTION FACTOR: 0.714

CANOGA PARK 50-YEAR 24-HOUR ISOHYET

1-HI.26



34° 15' 00"

SAN FERNANDO 1-HI.36

-118° 30' 00"

CANOGA PARK 1-HI.26

BURBANK 1-HI.28

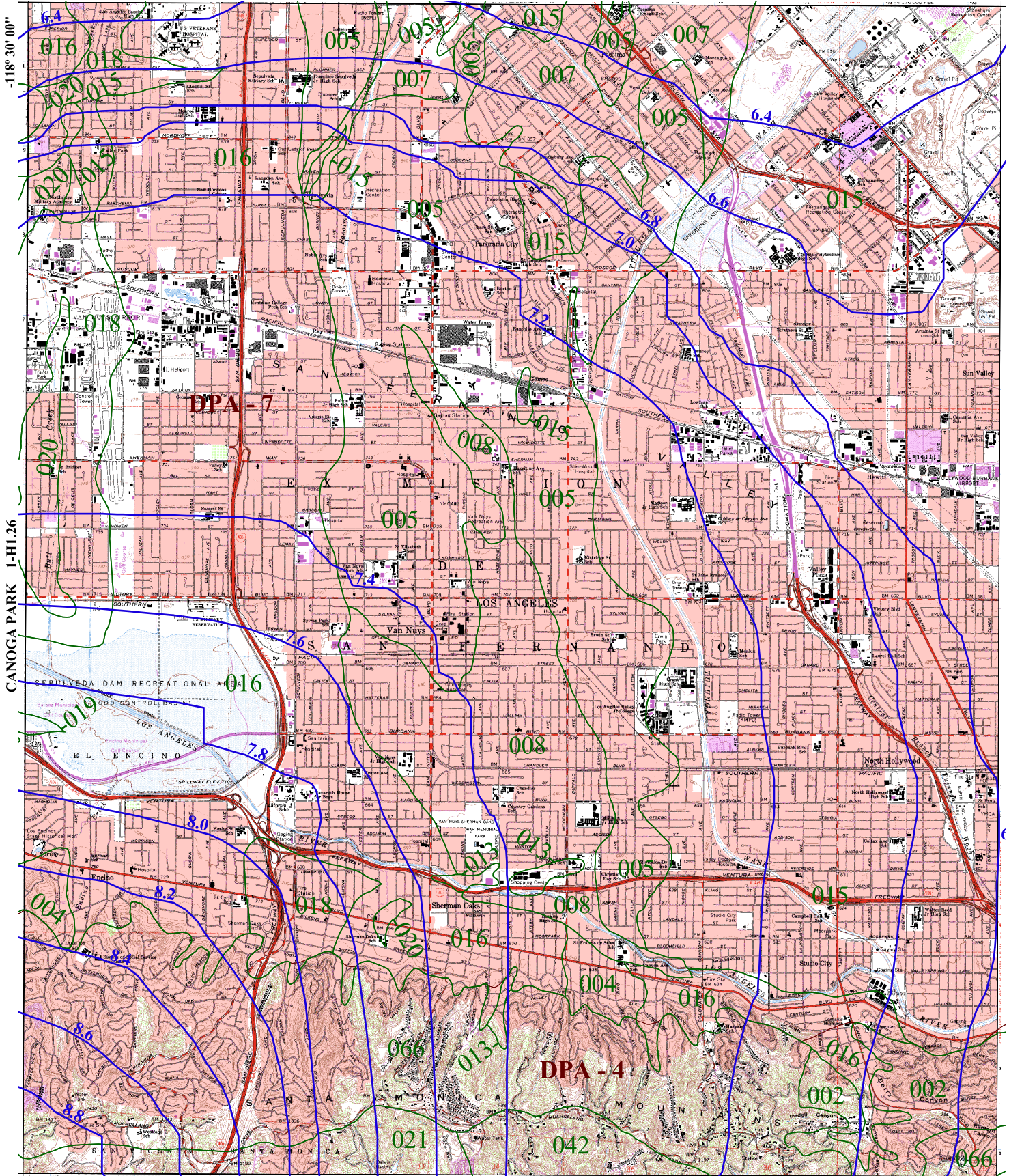

BEVERLY HILLS 1-HI.17

34° 07' 30"

-118° 22' 30"



016 SOIL CLASSIFICATION AREA

7.2 INCHES OF RAINFALL

DPA - 6 DEBRIS POTENTIAL AREA

1 0 1 2 Miles

25-YEAR 24-HOUR ISOHYET REDUCTION FACTOR: 0.878
10-YEAR 24-HOUR ISOHYET REDUCTION FACTOR: 0.714

VAN NUYS

50-YEAR 24-HOUR ISOHYET

1-HI.27



34° 15' 00"

SUNLAND 1-HI.37

-118° 22' 30"

VAN NUYS 1-HI.27

PASADENA 1-HI.29

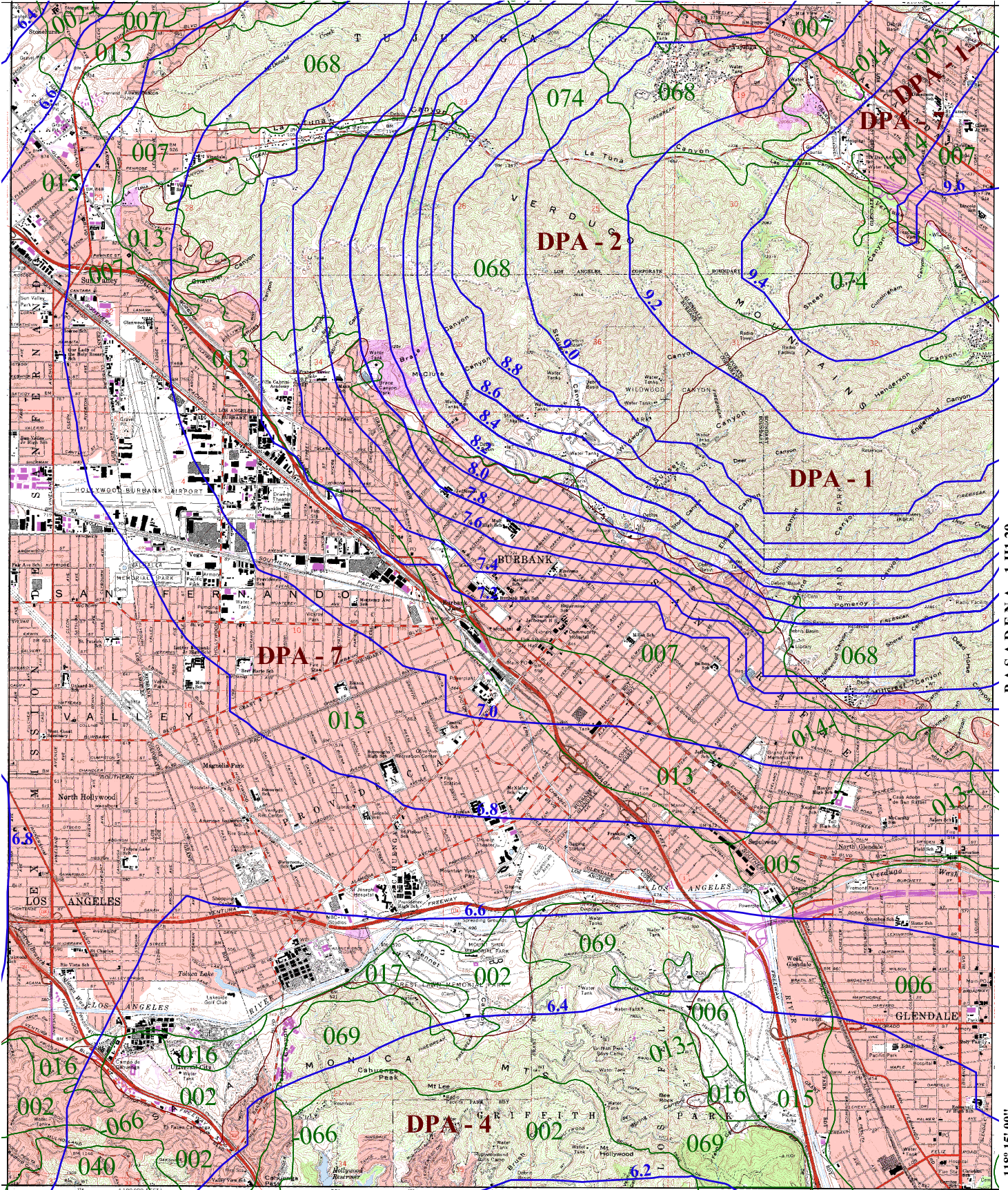

HOLLYWOOD 1-HI.18

34° 07' 30"

-118° 15' 00"



016 SOIL CLASSIFICATION AREA

7.2 INCHES OF RAINFALL

DPA - 6 DEBRIS POTENTIAL AREA

1 0 1 2 Miles

25-YEAR 24-HOUR ISOHYET REDUCTION FACTOR: 0.878
 10-YEAR 24-HOUR ISOHYET REDUCTION FACTOR: 0.714

BURBANK

50-YEAR 24-HOUR ISOHYET

1-HI.28



34° 15' 00"

CONDOR PEAK 1-HI.38

-118° 15' 00"

BURBANK 1-HI.28

MOUNT WILSON 1-HI.30

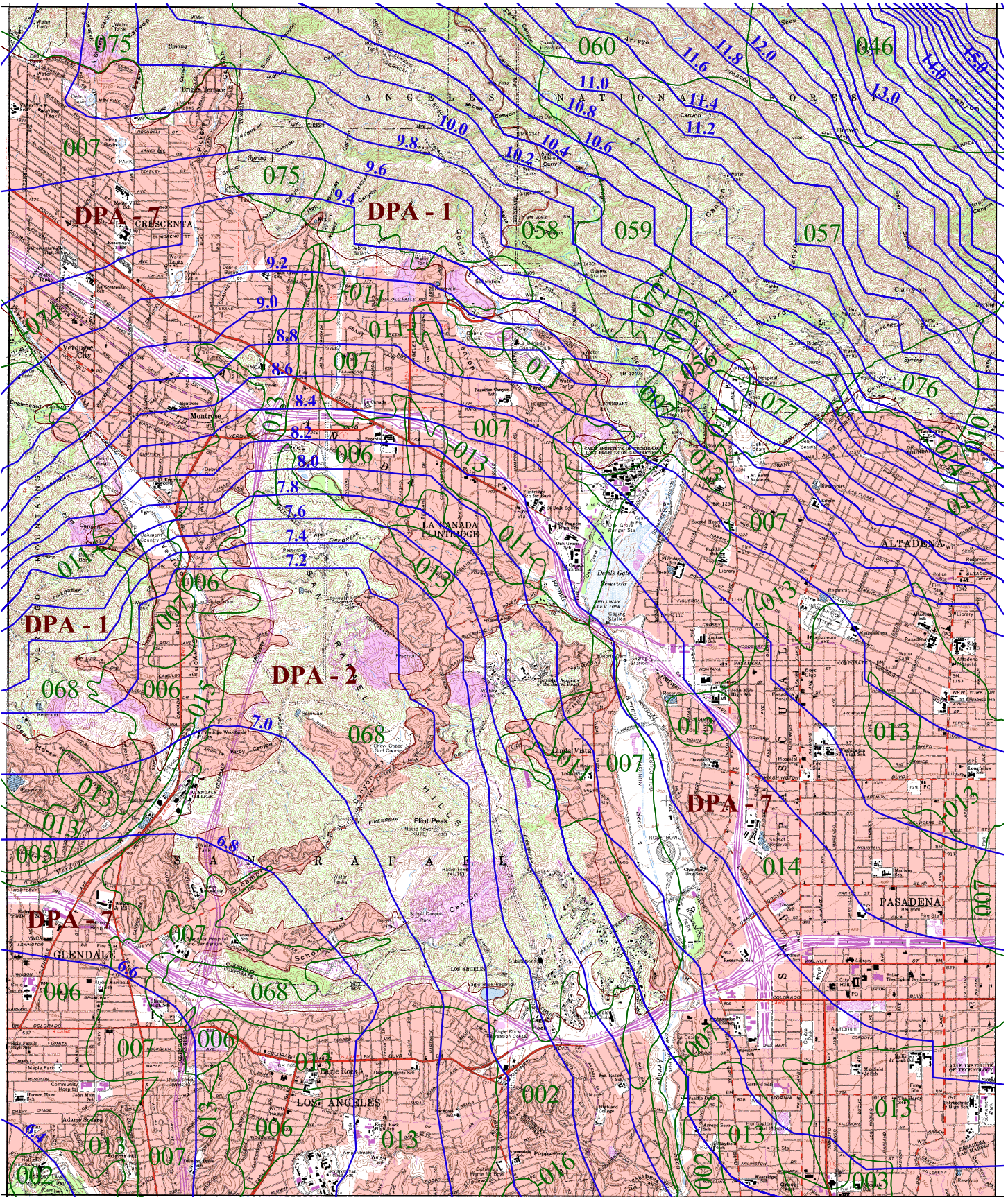

LOS ANGELES 1-HI.19

34° 07' 30"



016 SOIL CLASSIFICATION AREA

7.2 INCHES OF RAINFALL

DPA - 6 DEBRIS POTENTIAL AREA

1 0 1 2 Miles

25-YEAR 24-HOUR ISOHYET REDUCTION FACTOR: 0.878
 10-YEAR 24-HOUR ISOHYET REDUCTION FACTOR: 0.714

PASADENA 50-YEAR 24-HOUR ISOHYET

1-HI.29



34° 15' 00"

CHILAO FLAT 1-H1.39

-118° 07' 30"

PASADENA 1-H1.29

AZUSA 1-H1.31

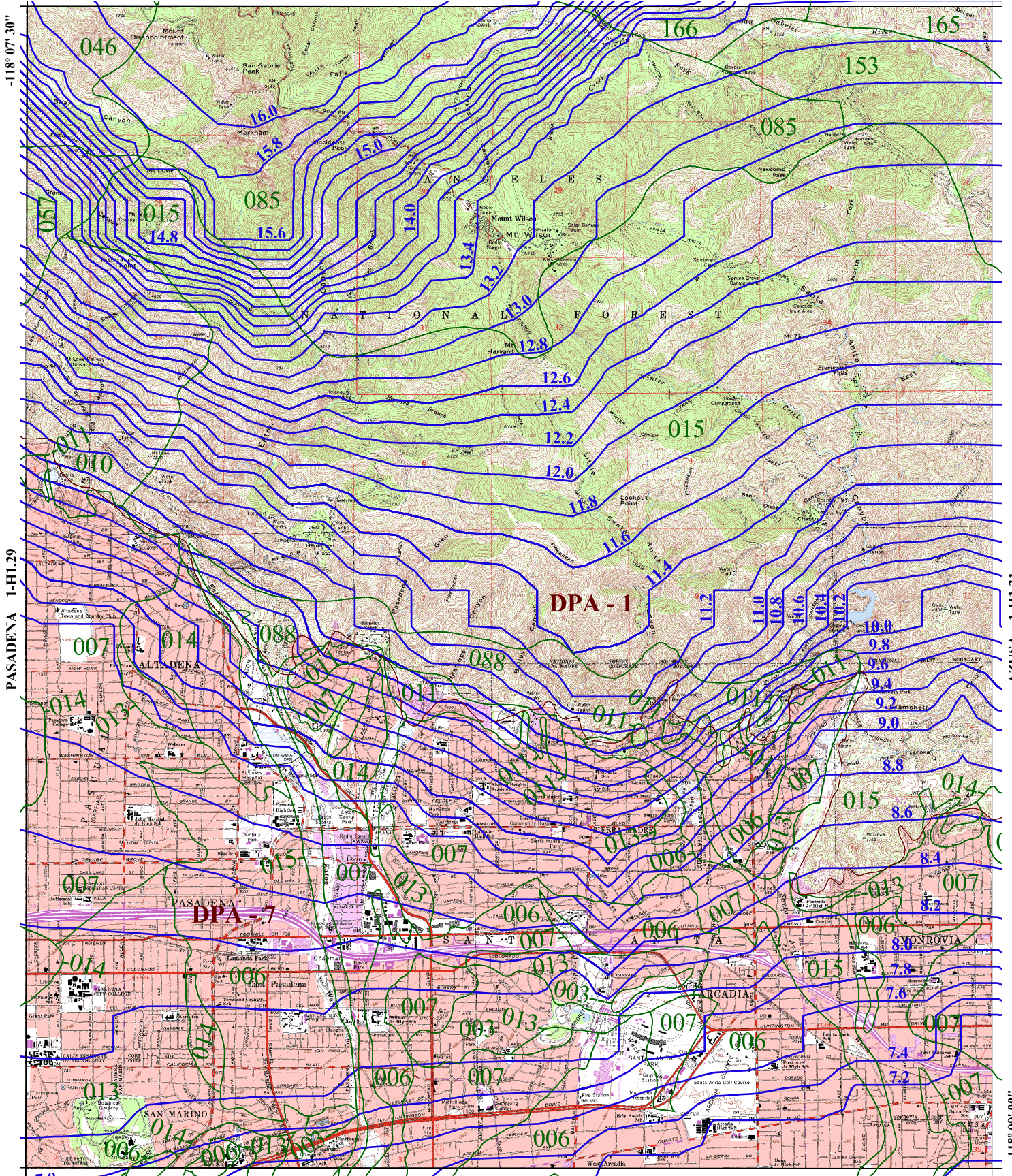

016 SOIL CLASSIFICATION AREA

7.2 INCHES OF RAINFALL

DPA - 6 DEBRIS POTENTIAL AREA

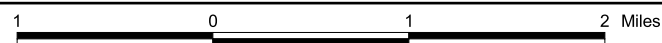

25-YEAR 24-HOUR ISOHYET REDUCTION FACTOR: 0.878
 10-YEAR 24-HOUR ISOHYET REDUCTION FACTOR: 0.714

MOUNT WILSON 50-YEAR 24-HOUR ISOHYET

1-H1.30



-118° 00' 00"

EL MONTE 1-H1.20

34° 07' 30"

34° 15' 00"

WATERMAN MOUNTAIN 1-H1.40

-118° 00' 00"

MOUNT WILSON 1-H1.30

GLENDORA 1-H1.32

-117° 52' 30"

BALDWIN PARK 1-H1.21

34° 07' 30"

1 0 1 2 Miles

25-YEAR 24-HOUR ISOHYET REDUCTION FACTOR: 0.878
10-YEAR 24-HOUR ISOHYET REDUCTION FACTOR: 0.714

A Z U S A

1-H1.31

50-YEAR 24-HOUR ISOHYET



016 SOIL CLASSIFICATION AREA

7.2 INCHES OF RAINFALL

DPA - 6 DEBRIS POTENTIAL AREA

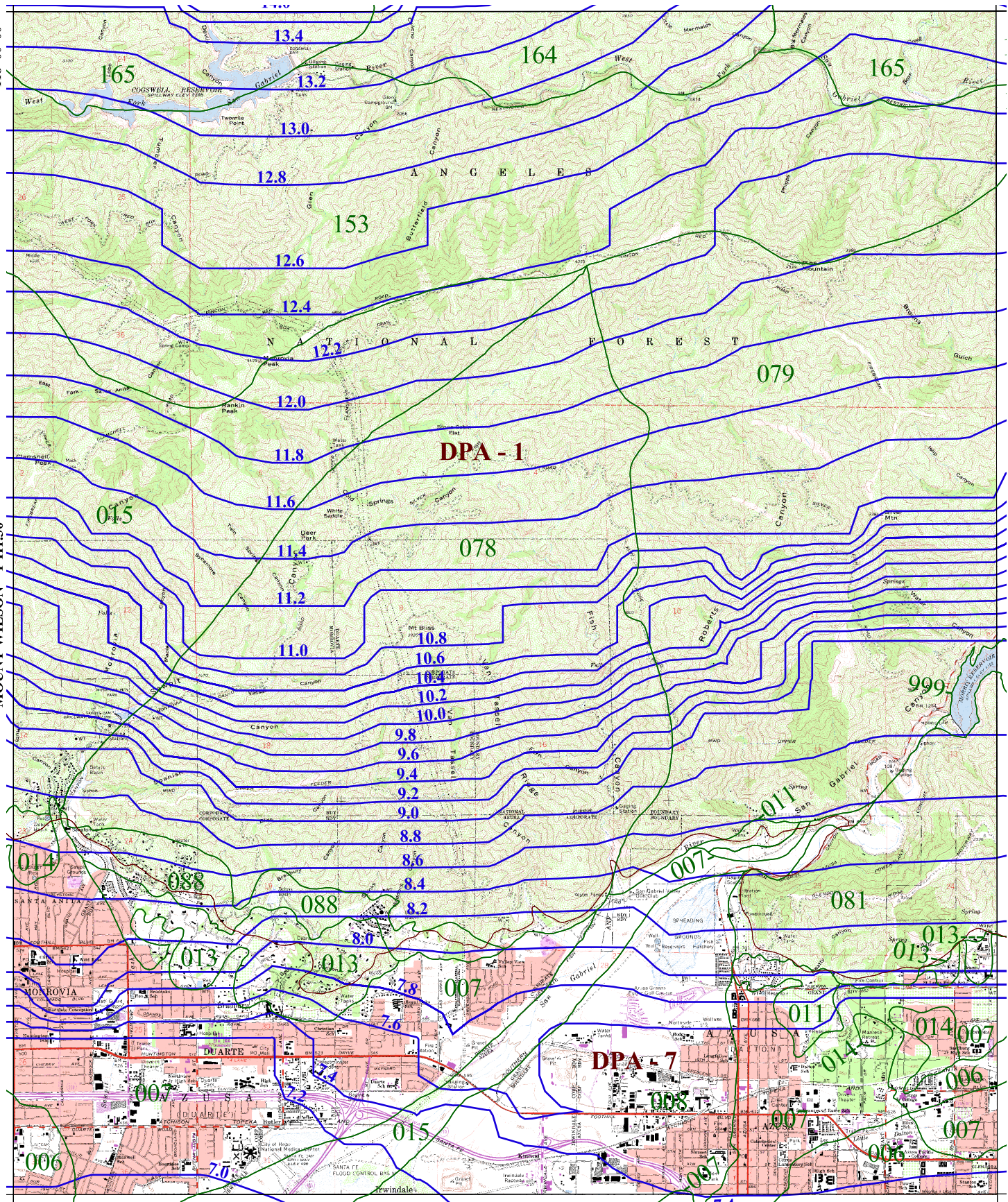

34° 15' 00"

CRYSTAL LAKE 1-H1.41

-117° 52' 30"

AZUSA 1-H1.31

MOUNT BALDY 1-H1.33

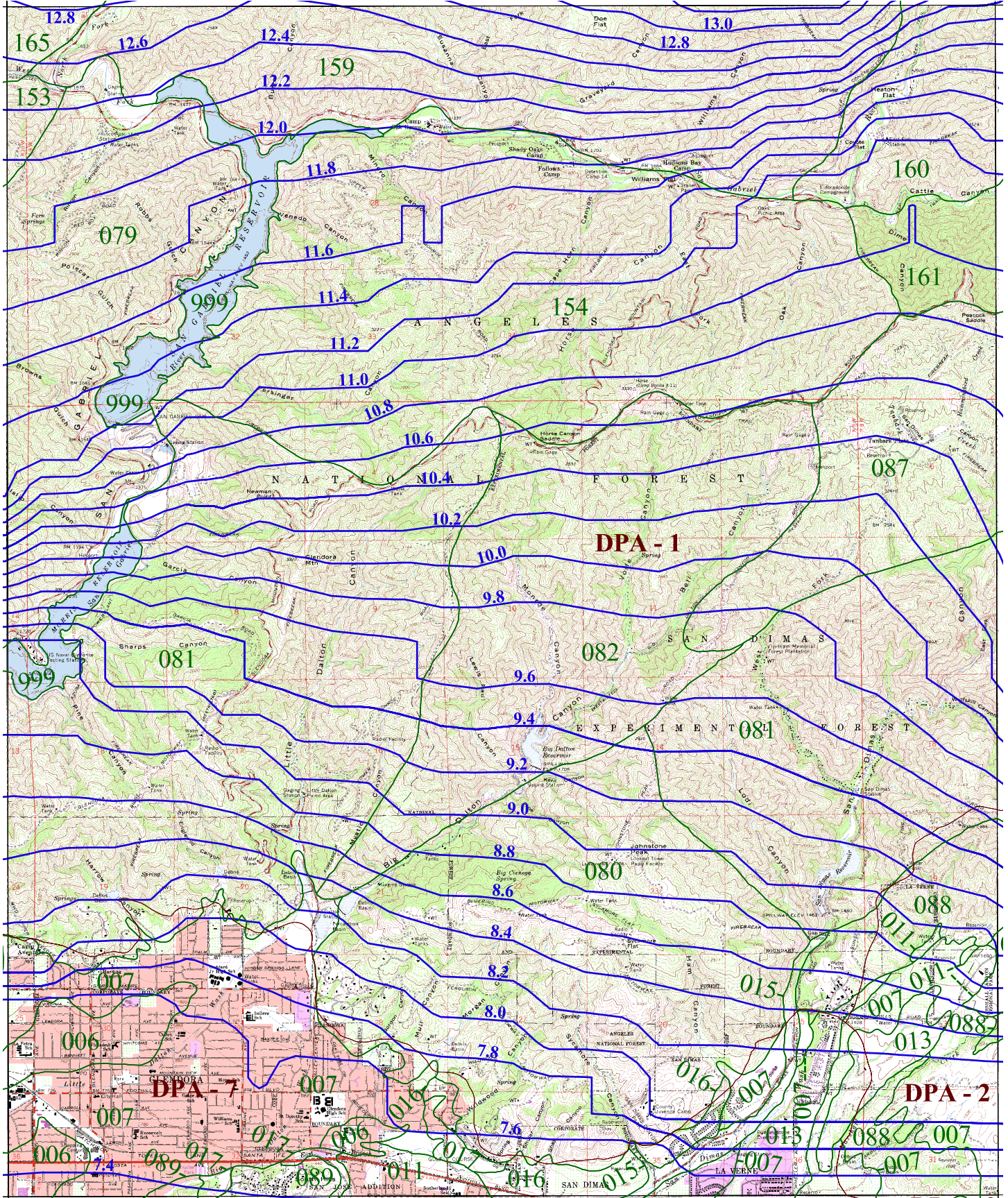

-117° 45' 00"

SAN DIMAS 1-H1.22

34° 07' 30"



016 SOIL CLASSIFICATION AREA

7.2 INCHES OF RAINFALL

DPA - 6 DEBRIS POTENTIAL AREA

1 0 1 2 Miles

25-YEAR 24-HOUR ISOHYET REDUCTION FACTOR: 0.878
 10-YEAR 24-HOUR ISOHYET REDUCTION FACTOR: 0.714

GLENDORA 50-YEAR 24-HOUR ISOHYET

1-H1.32



34° 15' 00"

MOUNT SAN ANTONIO 1-H1.42

-117° 45' 00"

GLENDORA 1-H1.32

CUCAMONGA PEAK

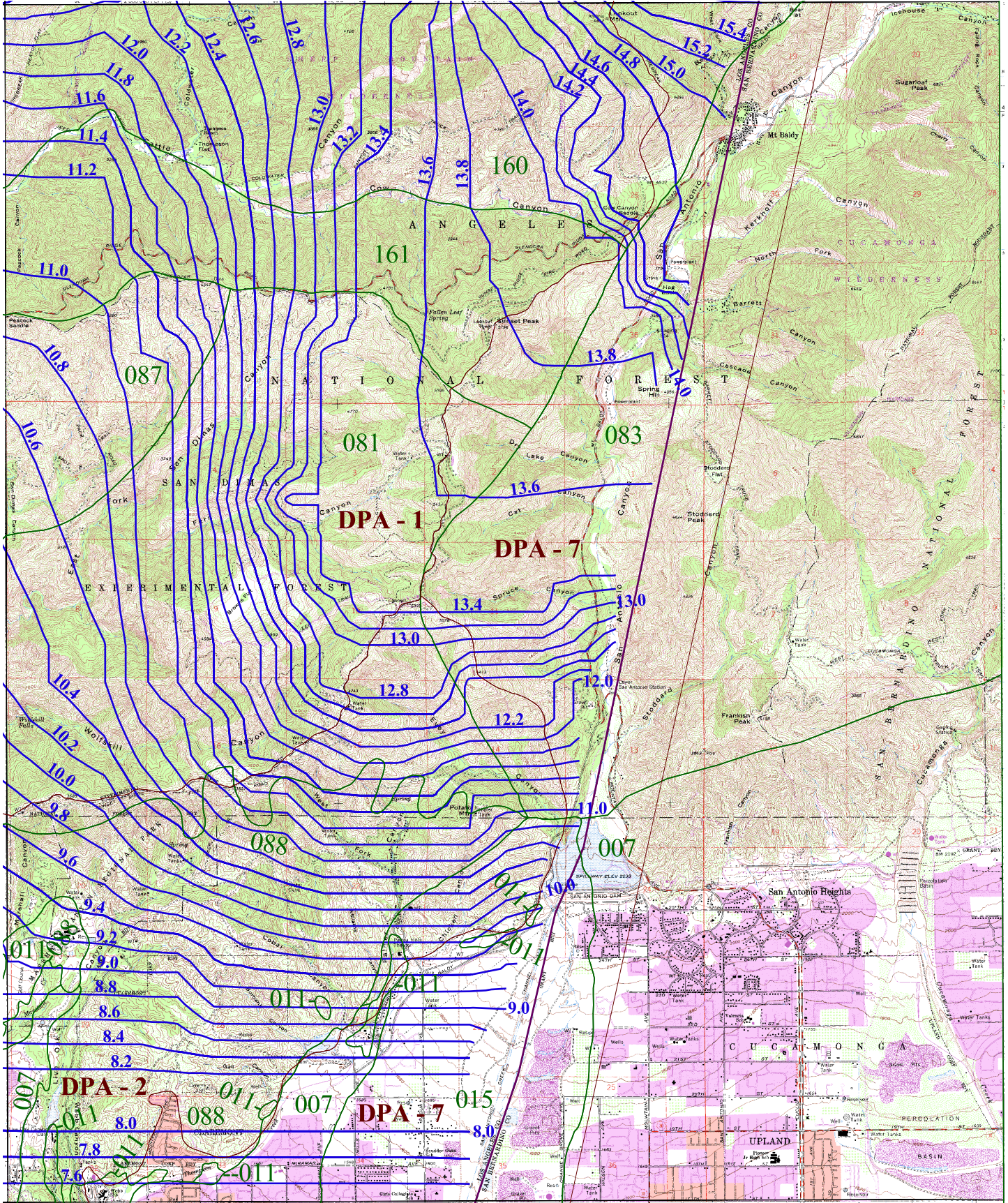

-117° 37' 30"

ONTARIO 1-H1.23

34° 07' 30"



- 016 SOIL CLASSIFICATION AREA
- 7.2 INCHES OF RAINFALL
- DPA - 6 DEBRIS POTENTIAL AREA

1 0 1 2 Miles

25-YEAR 24-HOUR ISOHYET REDUCTION FACTOR: 0.878
 10-YEAR 24-HOUR ISOHYET REDUCTION FACTOR: 0.714

MOUNT BALDY 50-YEAR 24-HOUR ISOHYET

1-H1.33



34° 22' 30"

VAL VERDE 1-HI.43

-118° 45' 00"

SIMI

OAT MOUNTAIN 1-HI.35

-118° 37' 30"

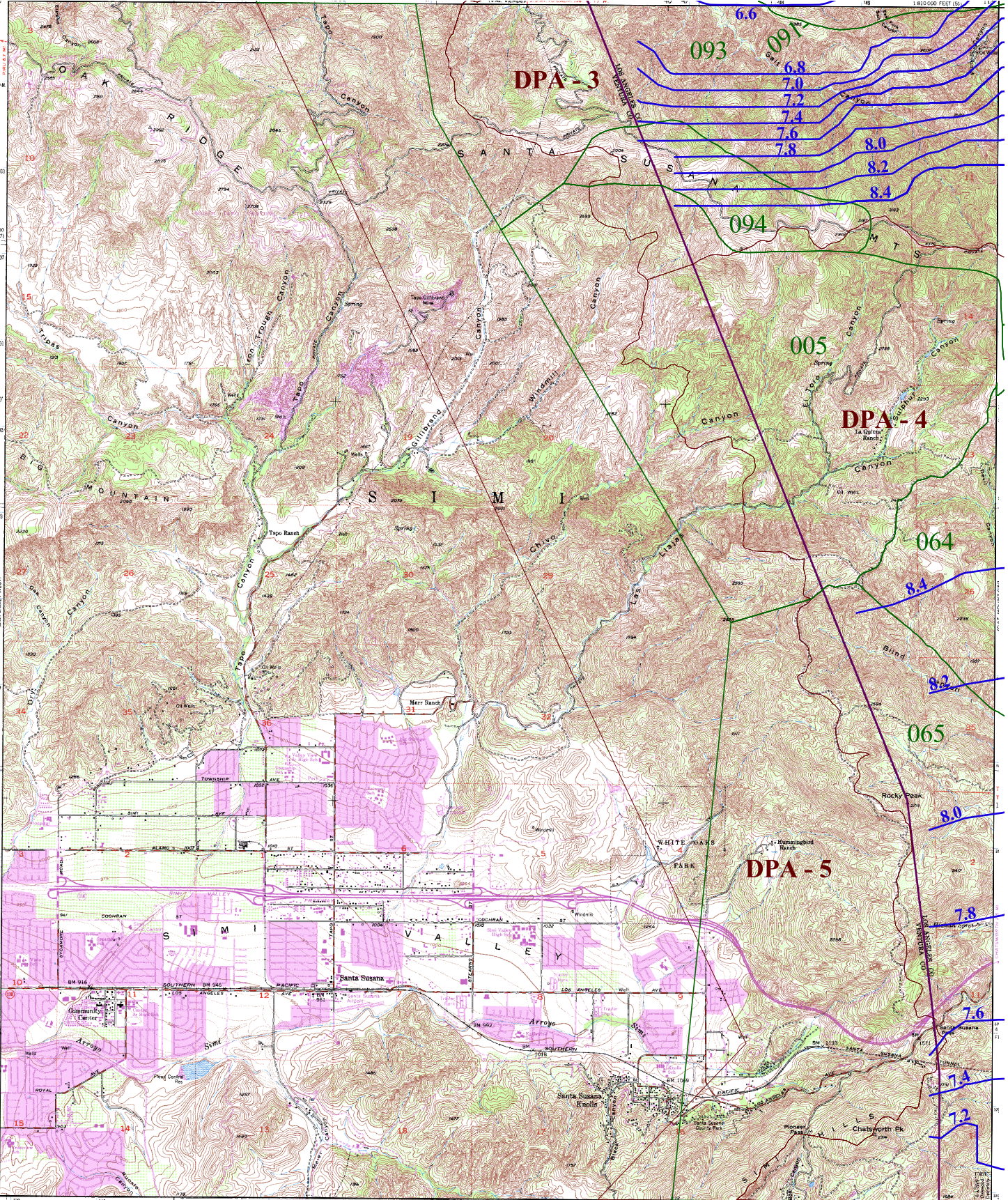

CALABASAS 1-HI.25

34° 15' 00"



016 SOIL CLASSIFICATION AREA

7.2 INCHES OF RAINFALL

DPA - 6 DEBRIS POTENTIAL AREA

1 0 1 2 Miles

25-YEAR 24-HOUR ISOHYET REDUCTION FACTOR: 0.878
 10-YEAR 24-HOUR ISOHYET REDUCTION FACTOR: 0.714

SANTA SUSANA

50-YEAR 24-HOUR ISOHYET

1-HI.34



34° 22' 30"

NEWHALL 1-HI.44

-118° 37' 30"

SANTA SUSANA 1-HI.34

SAN FERNANDO 1-HI.36

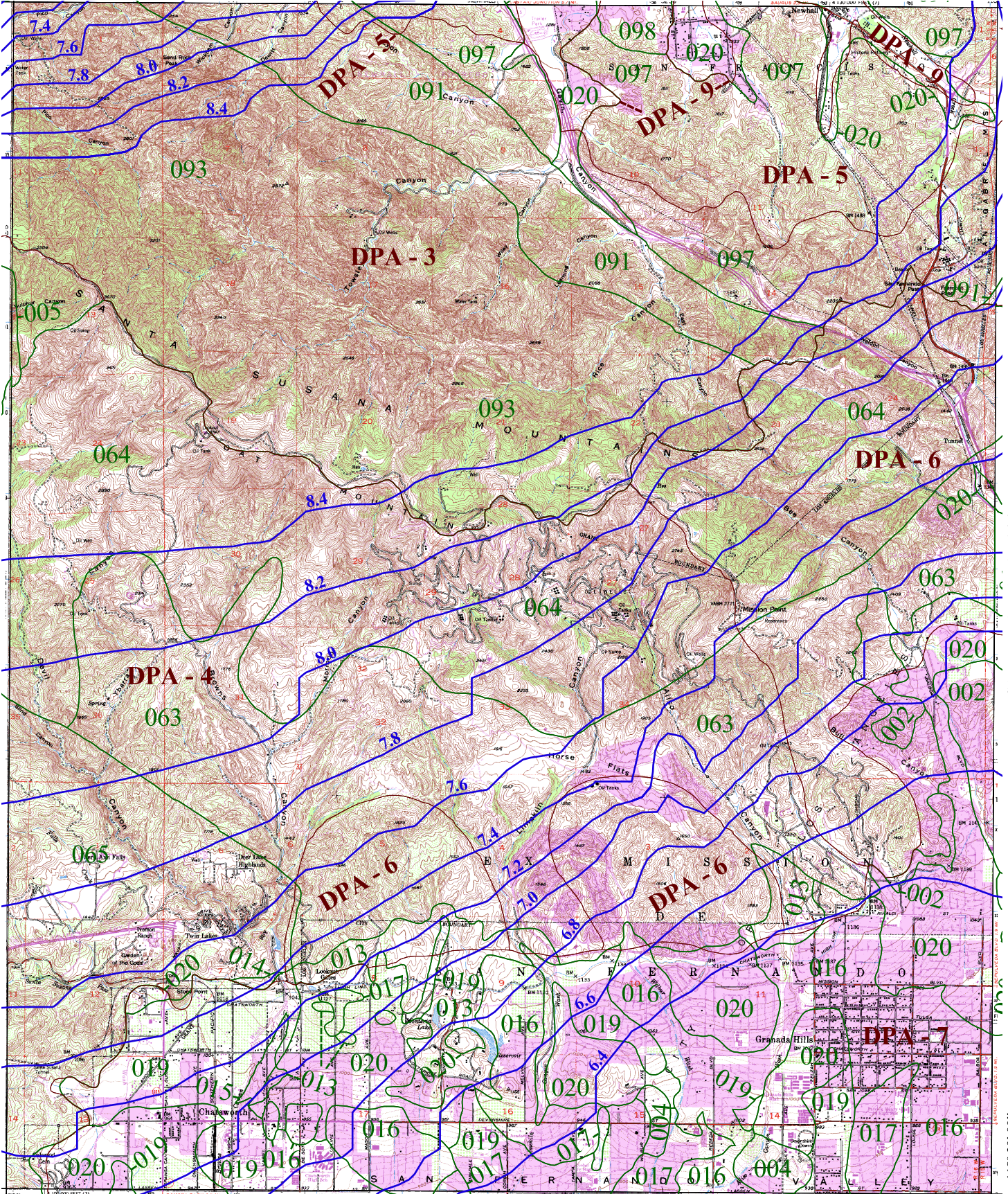

-118° 30' 00"

CANOGA PARK 1-HI.26

34° 15' 00"



016

SOIL CLASSIFICATION AREA

7.2

INCHES OF RAINFALL

DPA - 6

DEBRIS POTENTIAL AREA

1 0 1 2 Miles

25-YEAR 24-HOUR ISOHYET REDUCTION FACTOR: 0.878
10-YEAR 24-HOUR ISOHYET REDUCTION FACTOR: 0.714

OAT MOUNTAIN 50-YEAR 24-HOUR ISOHYET

1-HI.35



34° 22' 30"

MINT CANYON 1-HI.45

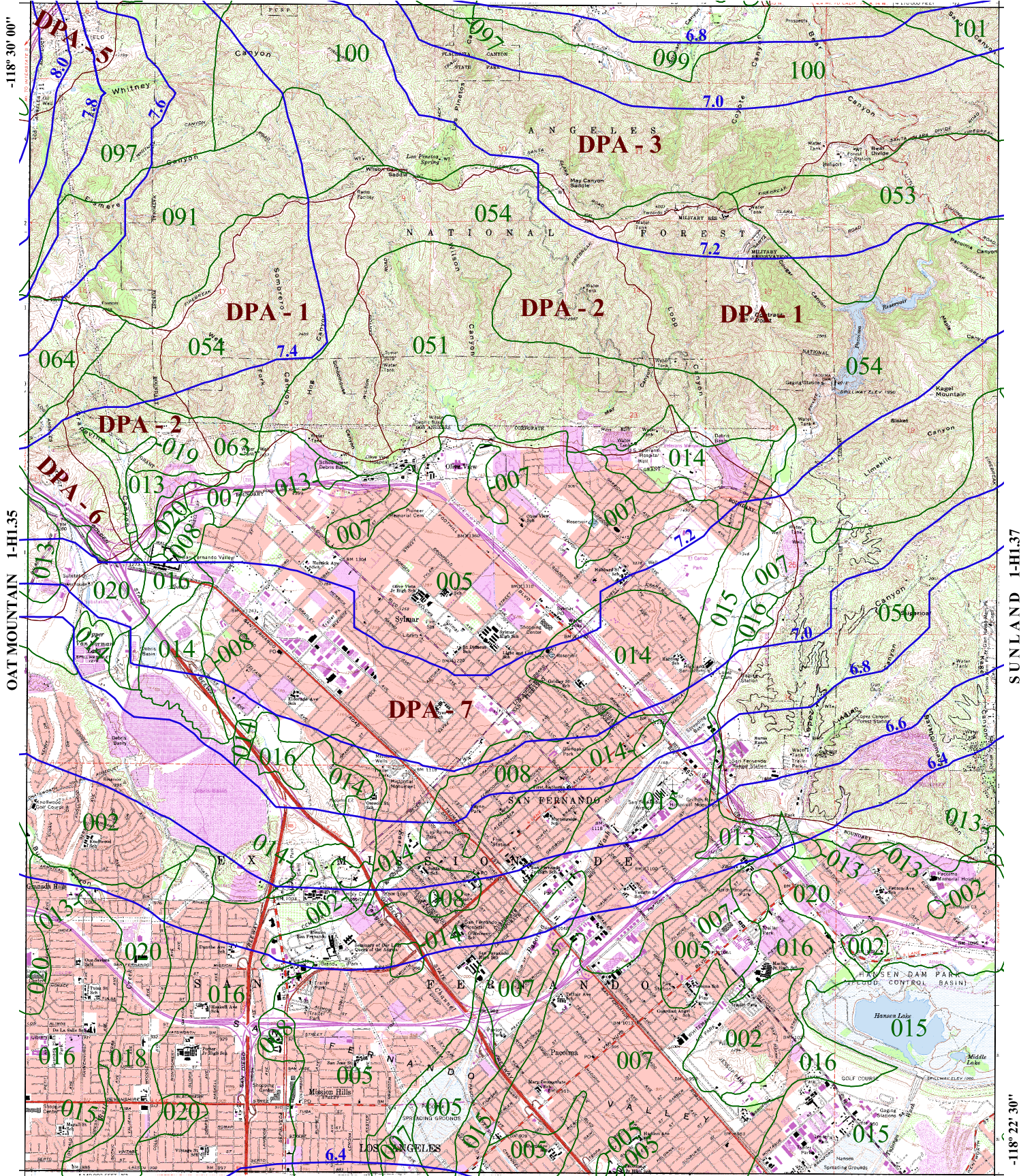

OAT MOUNTAIN 1-HI.35

SUNLAND 1-HI.37

VAN NUYS 1-HI.27

34° 15' 00"



016 SOIL CLASSIFICATION AREA

7.2 INCHES OF RAINFALL

DPA - 6 DEBRIS POTENTIAL AREA

1 0 1 2 Miles

25-YEAR 24-HOUR ISOHYET REDUCTION FACTOR: 0.878
 10-YEAR 24-HOUR ISOHYET REDUCTION FACTOR: 0.714

SAN FERNANDO 50-YEAR 24-HOUR ISOHYET

1-HI.36



34° 22' 30"

AGUA DULCE 1-HI.46

-118° 22' 30"

SAN FERNANDO 1-HI.36

CONDOR PEAK 1-HI.38

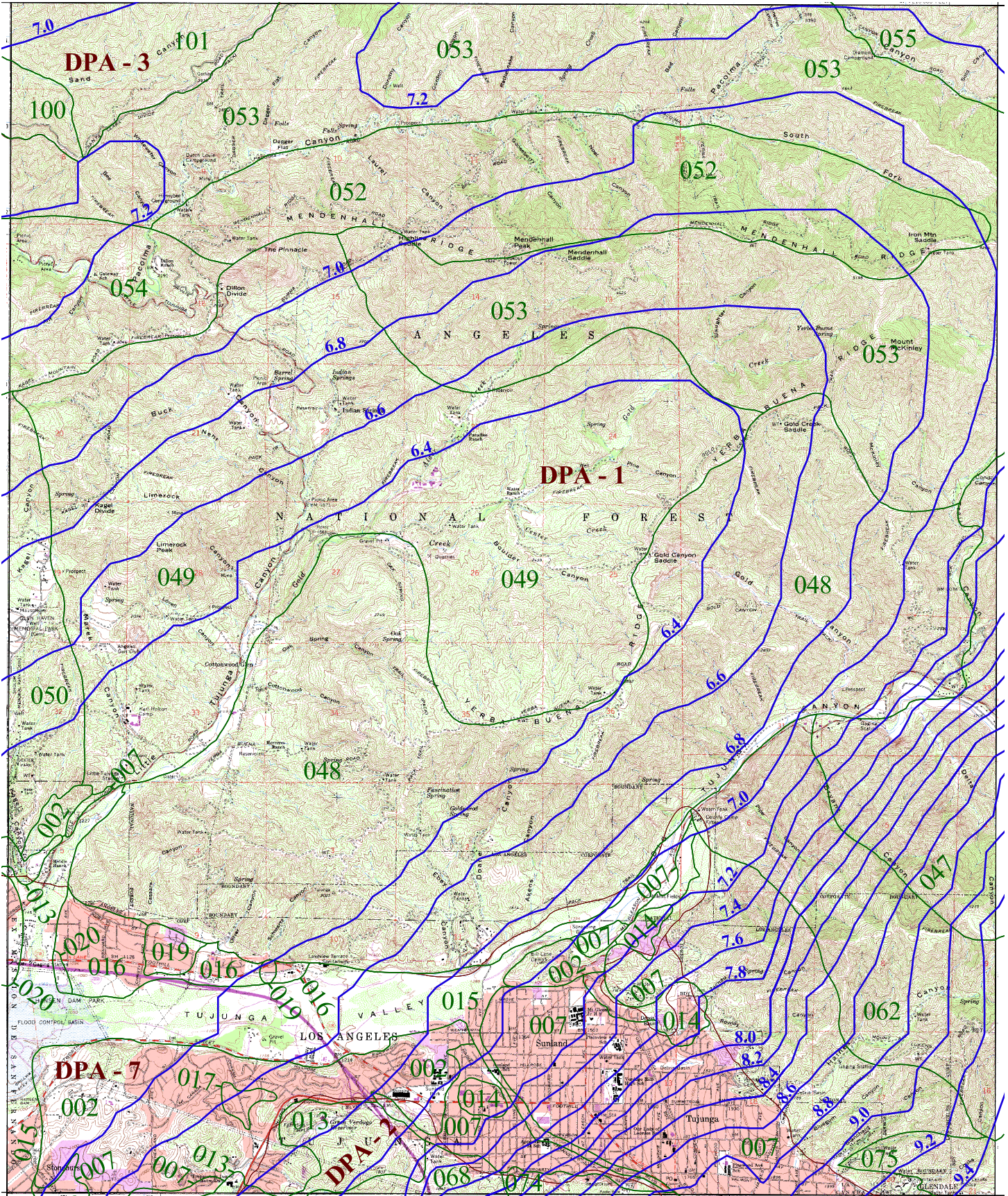

BURBANK 1-HI.28

34° 15' 00"



016 SOIL CLASSIFICATION AREA

7.2 INCHES OF RAINFALL

DPA - 6 DEBRIS POTENTIAL AREA

1 0 1 2 Miles

25-YEAR 24-HOUR ISOHYET REDUCTION FACTOR: 0.878

10-YEAR 24-HOUR ISOHYET REDUCTION FACTOR: 0.714

SUNLAND

50-YEAR 24-HOUR ISOHYET

1-HI.37



34° 22' 30"

ACTON 1-HI.47

-118° 15' 00"

SUNLAND 1-HI.37

CHILAO FLAT 1-HI.39

-118° 07' 30"

PASADENA 1-HI.29

34° 15' 00"

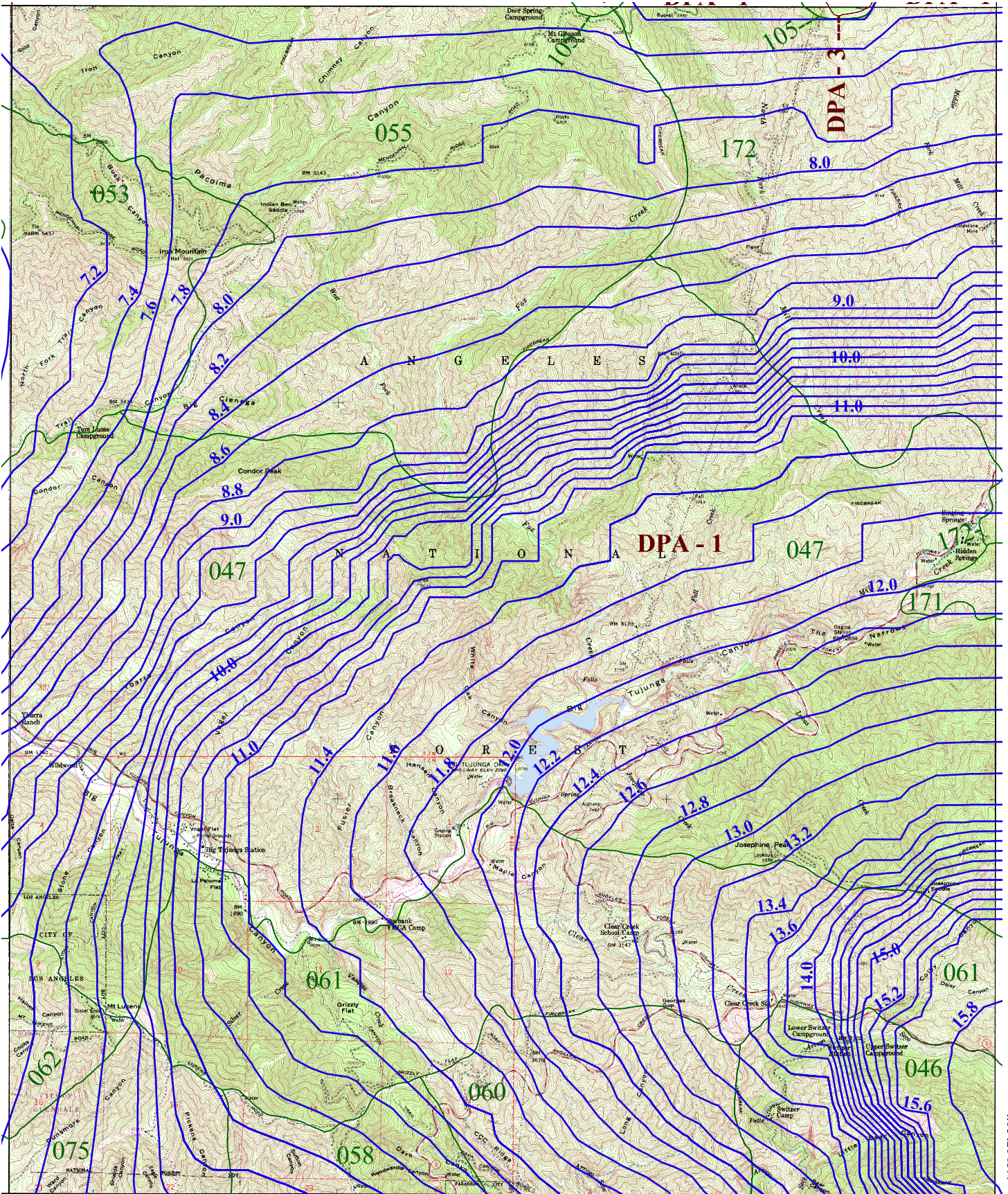

016 SOIL CLASSIFICATION AREA

7.2 INCHES OF RAINFALL

DPA - 6 DEBRIS POTENTIAL AREA

1 0 1 2 Miles

25-YEAR 24-HOUR ISOHYET REDUCTION FACTOR: 0.878
 10-YEAR 24-HOUR ISOHYET REDUCTION FACTOR: 0.714

CONDOR PEAK 50-YEAR 24-HOUR ISOHYET

1-HI.38



34° 22' 30"

PACIFICO MOUNTAIN 1-HI.48

-118° 07' 30"

CONDOR PEAK 1-HI.38

WATERMAN MOUNTAIN 1-HI.40

-118° 00' 00"

MOUNT WILSON 1-HI.33

34° 15' 00"



- 016** SOIL CLASSIFICATION AREA
- 7.2** INCHES OF RAINFALL
- DPA - 6** DEBRIS POTENTIAL AREA

1 0 1 2 Miles

25-YEAR 24-HOUR ISOHYET REDUCTION FACTOR: 0.878
10-YEAR 24-HOUR ISOHYET REDUCTION FACTOR: 0.714

CHILAO FLAT 50-YEAR 24-HOUR ISOHYET

1-HI.39

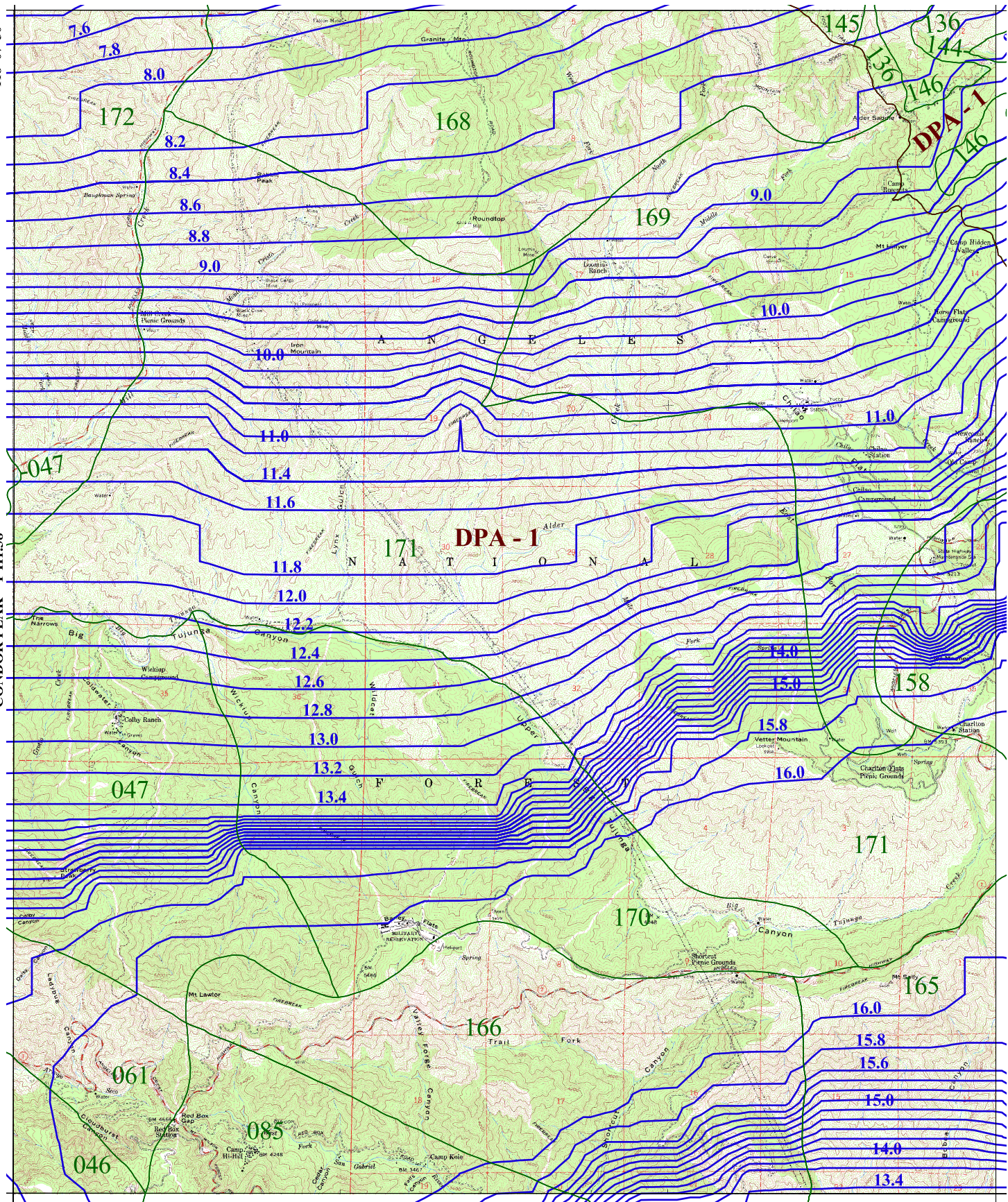

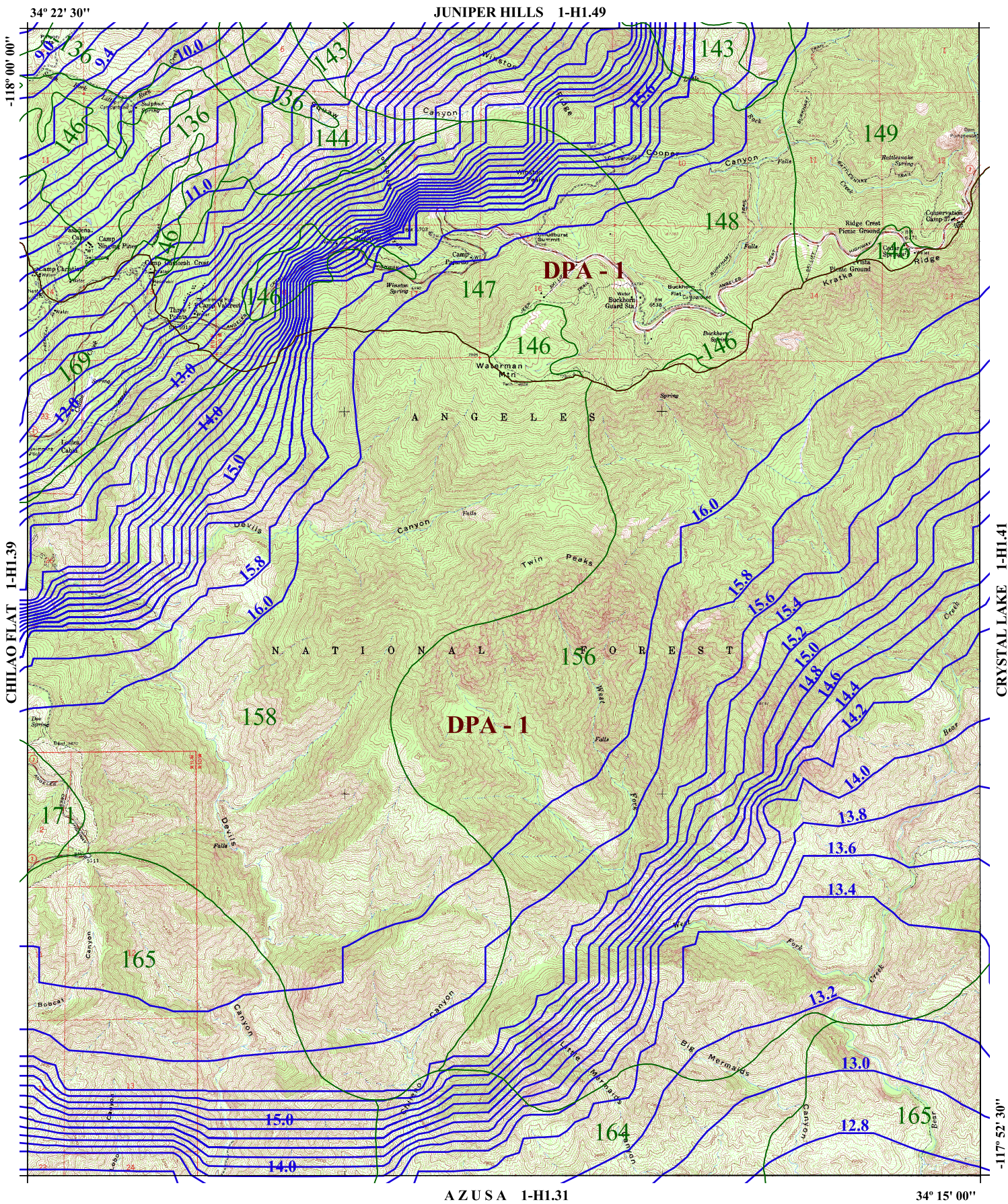

- 016 SOIL CLASSIFICATION AREA
- 7.2 INCHES OF RAINFALL
- DPA - 6 DEBRIS POTENTIAL AREA

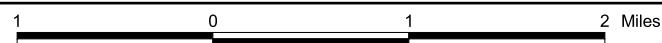

25-YEAR 24-HOUR ISOHYET REDUCTION FACTOR: 0.878
 10-YEAR 24-HOUR ISOHYET REDUCTION FACTOR: 0.714

WATERMAN MOUNTAIN 50-YEAR 24-HOUR ISOHYET

1-H1.40



34° 22' 30"

VALYERMO 1-HI.50

-117° 52' 30"

WATERMAN MOUNTAIN 1-HI.40

MOUNT SAN ANTONIO 1-HI.42

-117° 45' 00"

GLENDORA 1-HI.32

34° 15' 00"



016 SOIL CLASSIFICATION AREA

7.2 INCHES OF RAINFALL

DPA - 6 DEBRIS POTENTIAL AREA

1 0 1 2 Miles

25-YEAR 24-HOUR ISOHYET REDUCTION FACTOR: 0.878
10-YEAR 24-HOUR ISOHYET REDUCTION FACTOR: 0.714

CRYSTAL LAKE 50-YEAR 24-HOUR ISOHYET

1-HI.41

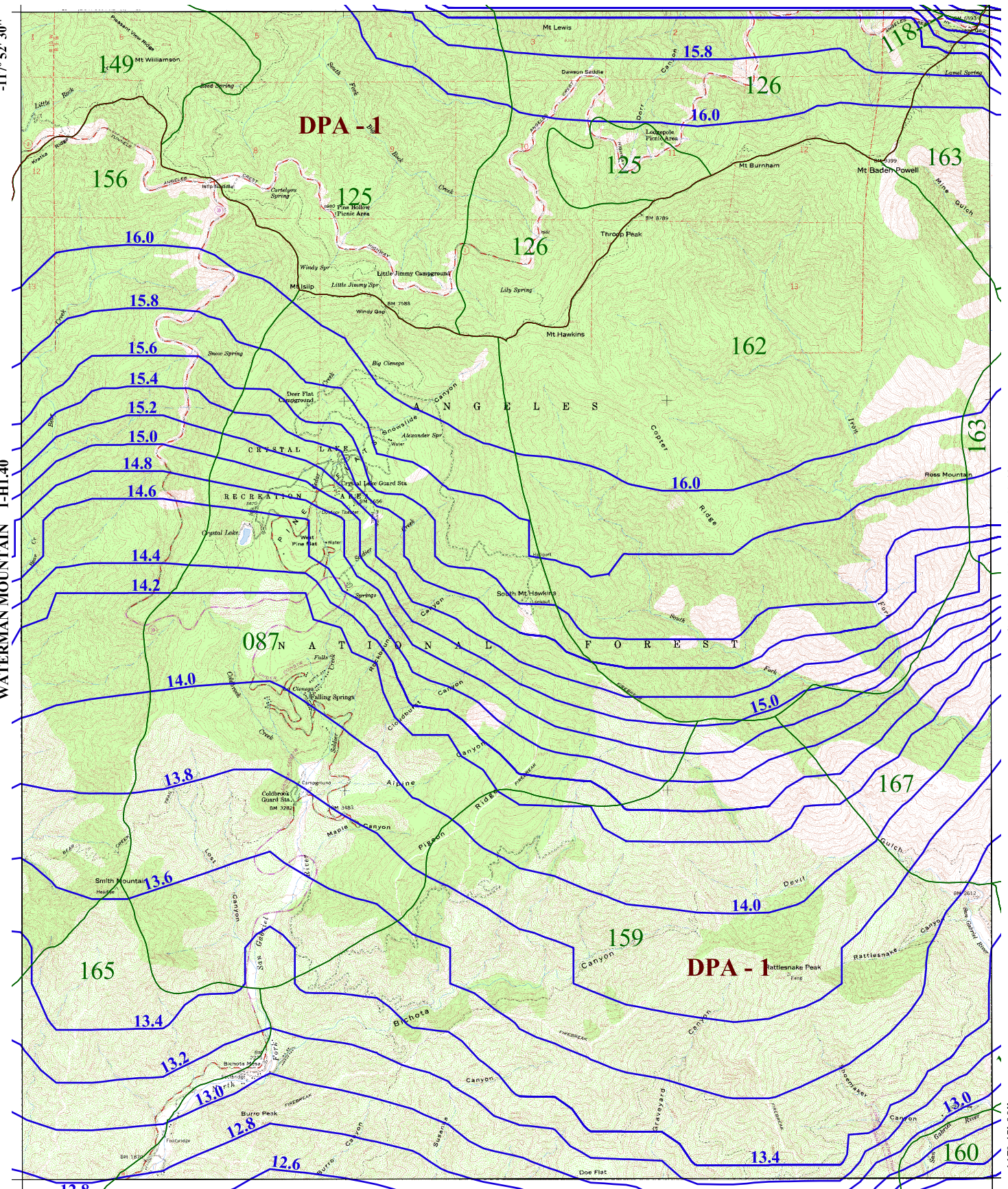

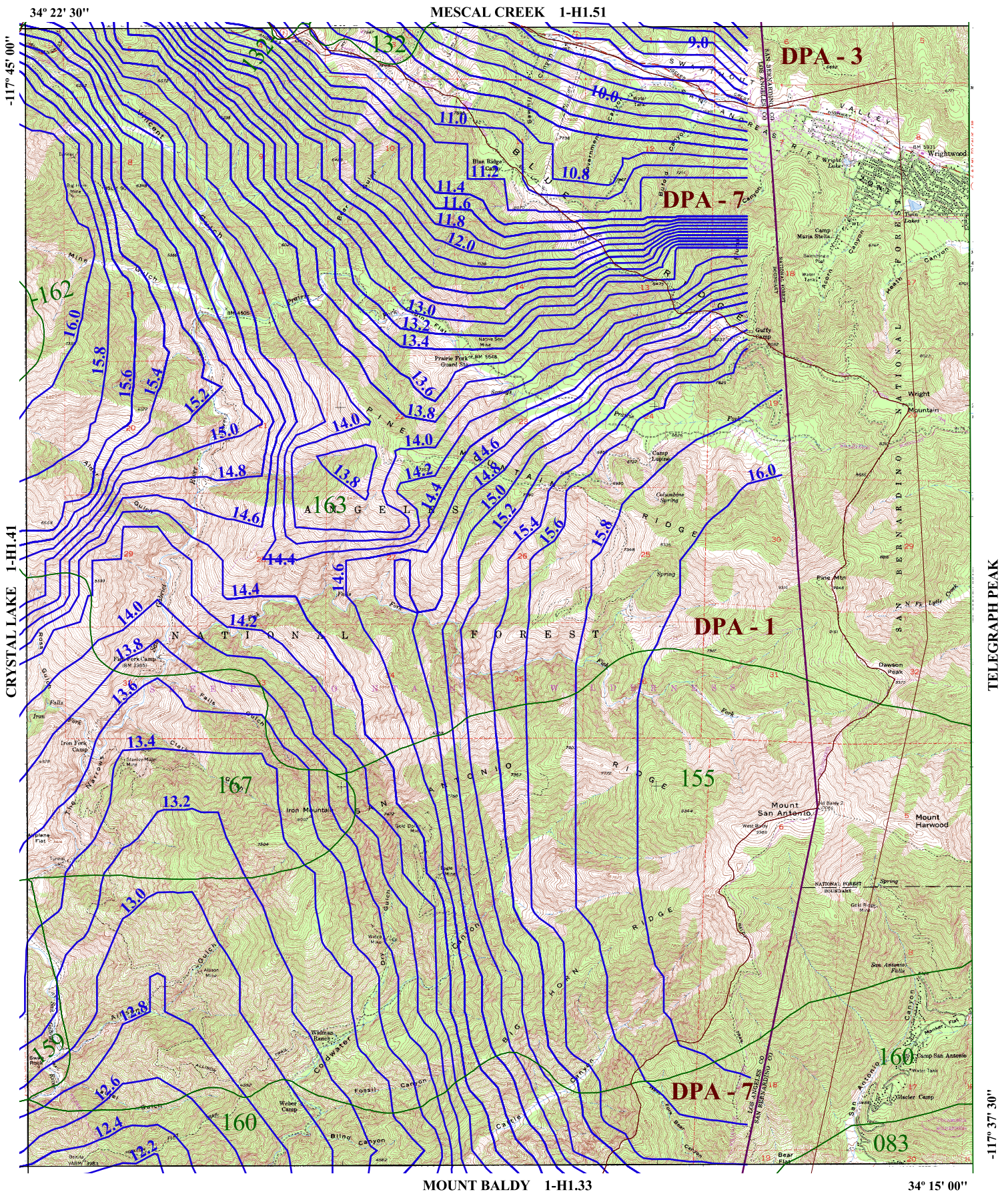



016 SOIL CLASSIFICATION AREA

7.2 INCHES OF RAINFALL

DPA - 6 DEBRIS POTENTIAL AREA

1 0 1 2 Miles

 25-YEAR 24-HOUR ISOHYET REDUCTION FACTOR: 0.878

 10-YEAR 24-HOUR ISOHYET REDUCTION FACTOR: 0.714

MOUNT SAN ANTONIO

50-YEAR 24-HOUR ISOHYET

1-H1.42



34° 30' 00"

WHITAKER PEAK 1-H1.53

-118° 45' 00"

PIRU

NEWHALL 1-H1.44

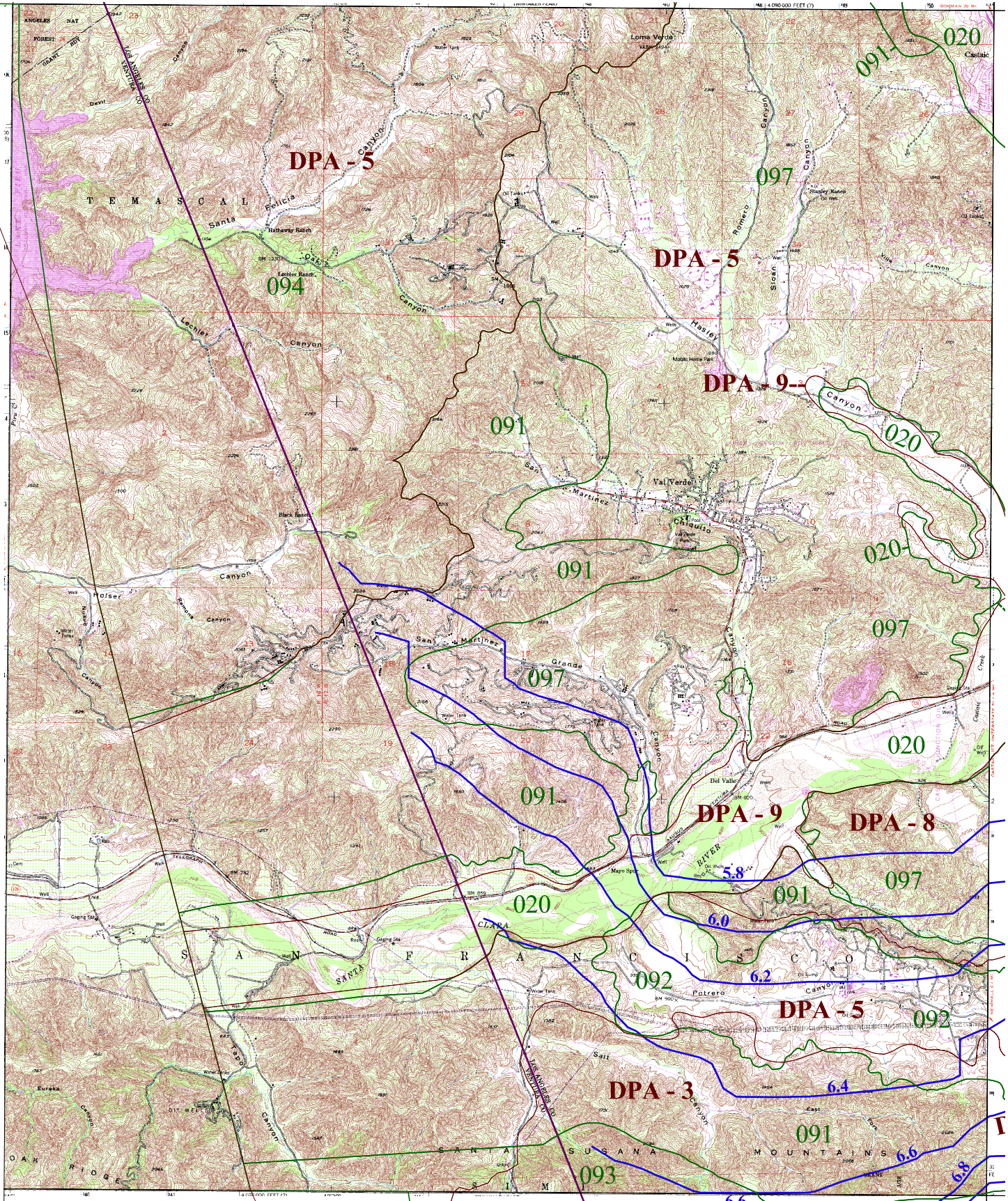

SANTA SUSANA 1-H1.34

34° 22' 30"



016

SOIL CLASSIFICATION AREA

7.2

INCHES OF RAINFALL

DPA - 6

DEBRIS POTENTIAL AREA

1 0 1 2 Miles

25-YEAR 24-HOUR ISOHYET REDUCTION FACTOR: 0.878
10-YEAR 24-HOUR ISOHYET REDUCTION FACTOR: 0.714

VAL VERDE 50-YEAR 24-HOUR ISOHYET

1-H1.43



34° 30' 00"

WARM SPRINGS MOUNTAIN 1-HI.53

-118° 37' 30"

VAL VERDE 1-HI.43

MINT CANYON 1-HI.45

-118° 30' 00"

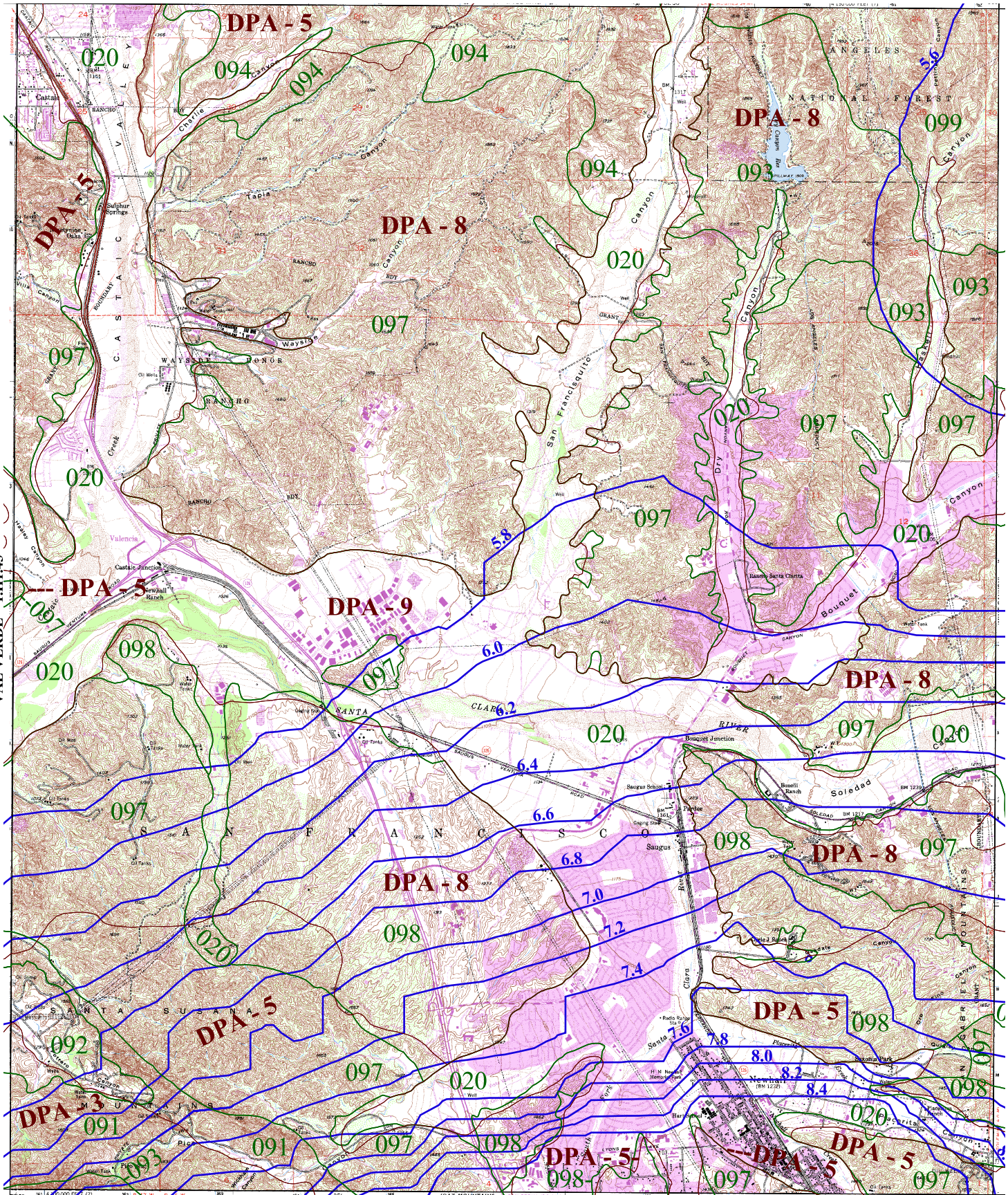

OAT MOUNTAIN 1-HI.35

34° 22' 30"



016 SOIL CLASSIFICATION AREA

7.2 INCHES OF RAINFALL

DPA - 6 DEBRIS POTENTIAL AREA

1 0 1 2 Miles

25-YEAR 24-HOUR ISOHYET REDUCTION FACTOR: 0.878
10-YEAR 24-HOUR ISOHYET REDUCTION FACTOR: 0.714

NEW HALL 50-YEAR 24-HOUR ISOHYET

1-HI.44



34° 30' 00"

GREEN VALLEY 1-HI.55

-118° 30' 00"

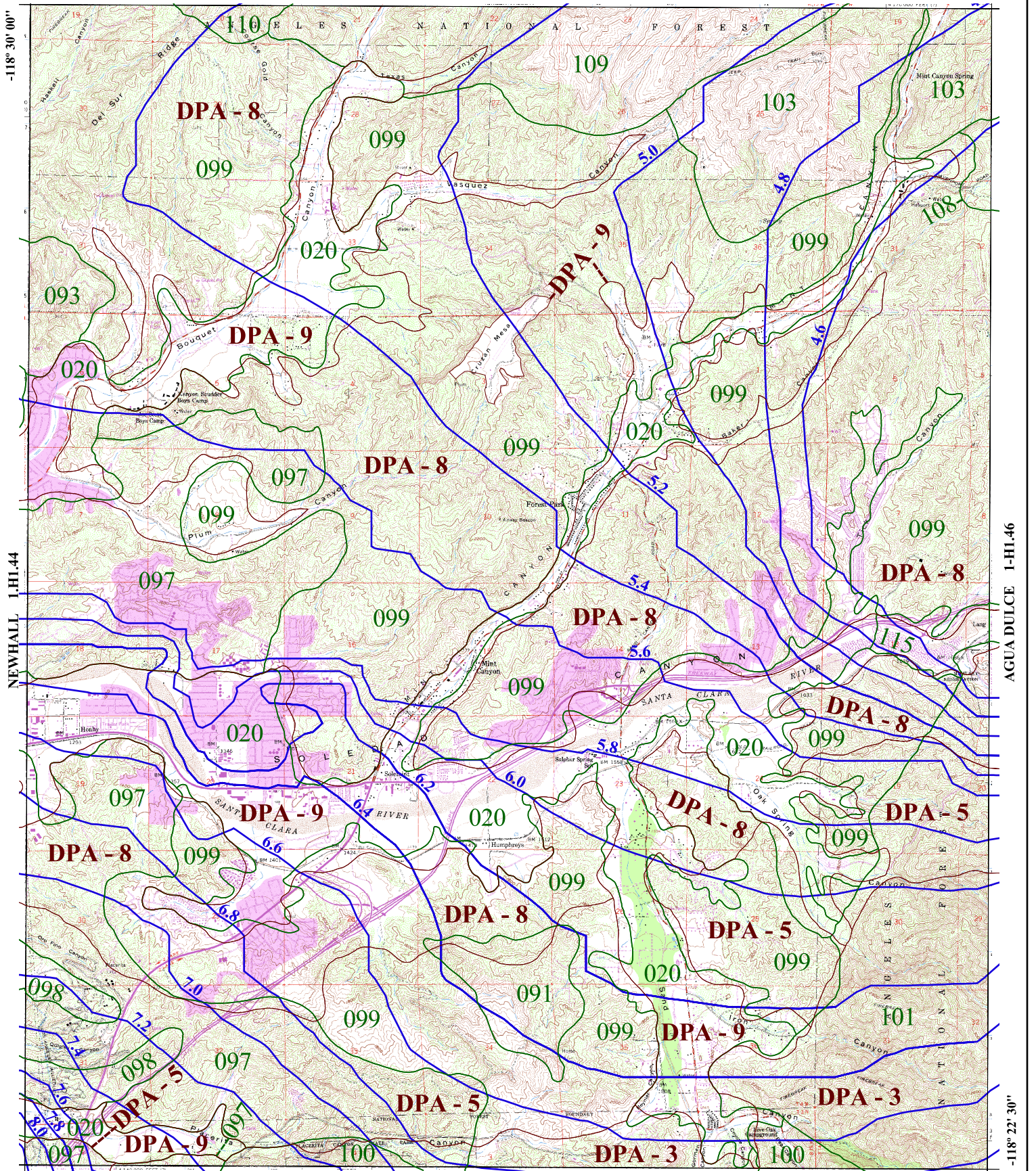

NEWHALL 1-HI.44

AGUA DULCE 1-HI.46

-118° 22' 30"

SAN FERNANDO 1-HI.36

34° 22' 30"



016 SOIL CLASSIFICATION AREA

7.2 INCHES OF RAINFALL

DPA - 6 DEBRIS POTENTIAL AREA

1 0 1 2 Miles

25-YEAR 24-HOUR ISOHYET REDUCTION FACTOR: 0.878
10-YEAR 24-HOUR ISOHYET REDUCTION FACTOR: 0.714

MINT CANYON 50-YEAR 24-HOUR ISOHYET

1-HI.45



34° 30' 00"

SLEEPY VALLEY 1-H1.56

-118° 22' 30"

MINT CANYON 1-H1.46

ACTON 1-H1.47

-118° 15' 00"

SUNLAND 1-H1.37

34° 22' 30"

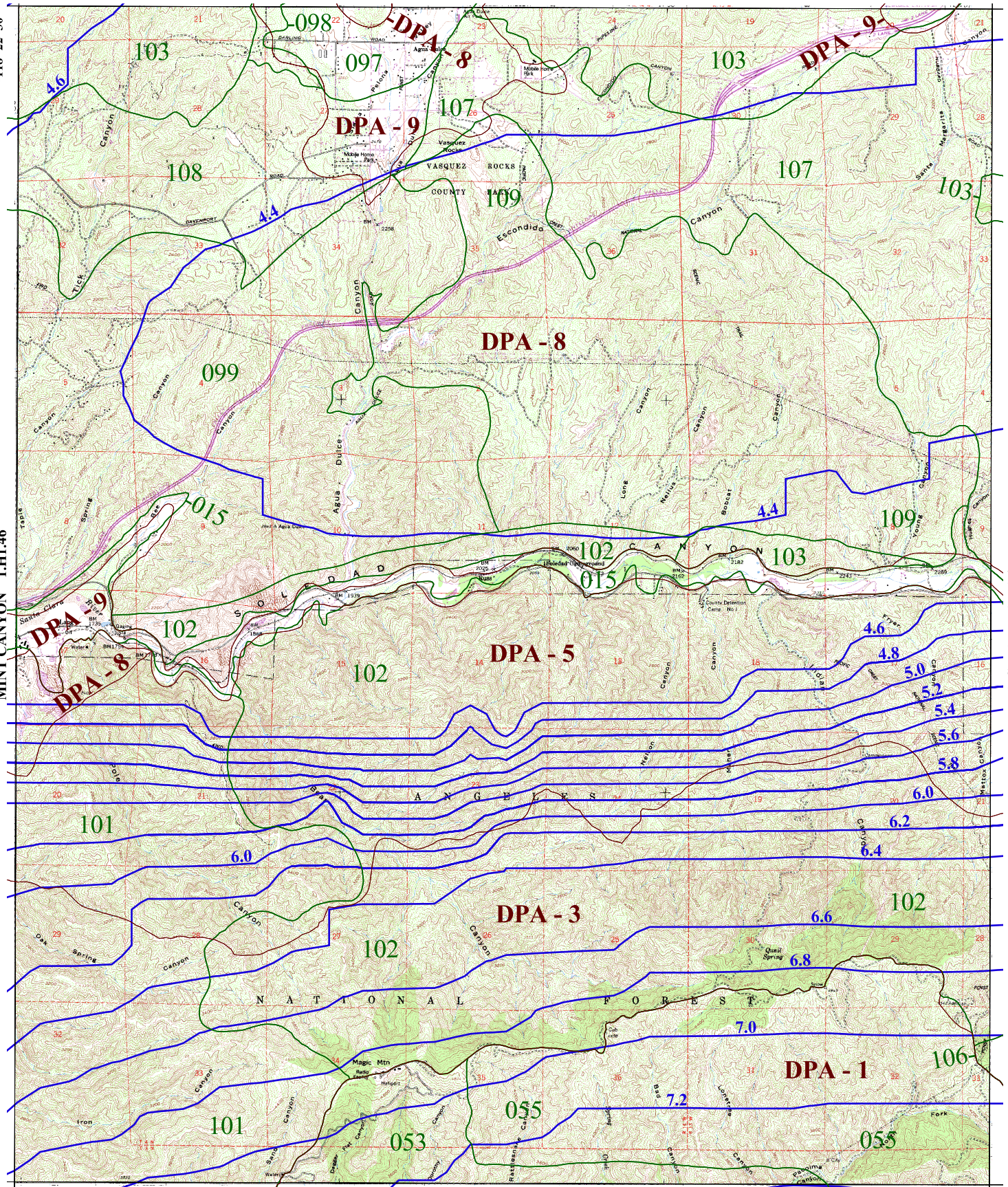

016
SOIL CLASSIFICATION AREA

7.2
INCHES OF RAINFALL

DPA - 6
DEBRIS POTENTIAL AREA

1 0 1 2 Miles

25-YEAR 24-HOUR ISOHYET REDUCTION FACTOR: 0.878
10-YEAR 24-HOUR ISOHYET REDUCTION FACTOR: 0.714

AGUA DULCE 50-YEAR 24-HOUR ISOHYET

1-H1.46



34° 30' 00"

RITTER RIDGE 1-H1.57

-118° 15' 00"

AGUA DULCE 1-H1.46

PACIFICO MOUNTAIN 1-H1.48

-118° 07' 30"

CONDOR PEAK 1-H1.38

34° 22' 30"

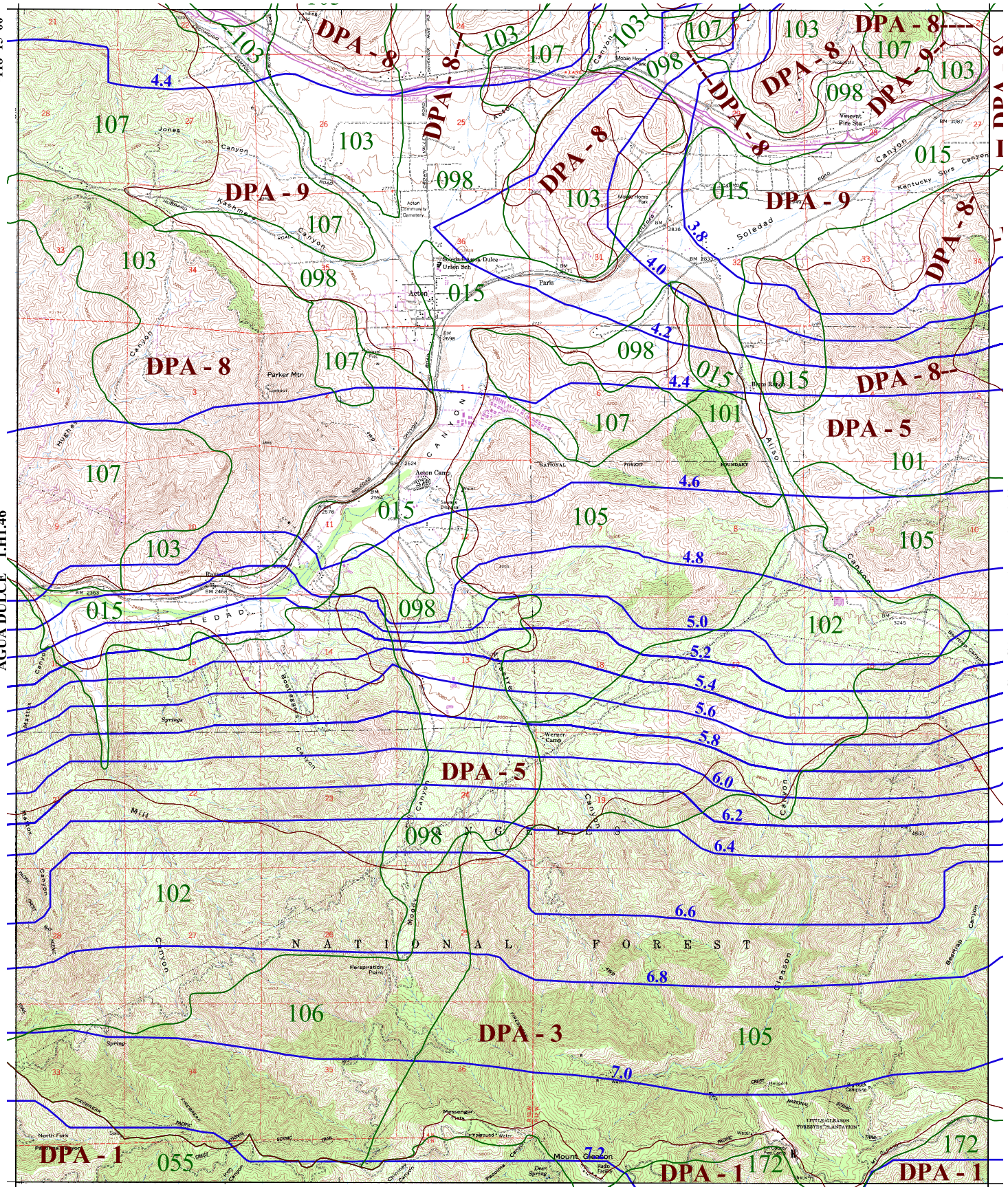

016
SOIL CLASSIFICATION AREA

7.2
INCHES OF RAINFALL

DPA - 6
DEBRIS POTENTIAL AREA

1 0 1 2 Miles

25-YEAR 24-HOUR ISOHYET REDUCTION FACTOR: 0.878
10-YEAR 24-HOUR ISOHYET REDUCTION FACTOR: 0.714

A C T O N

50-YEAR 24-HOUR ISOHYET

1-H1.47



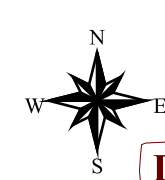
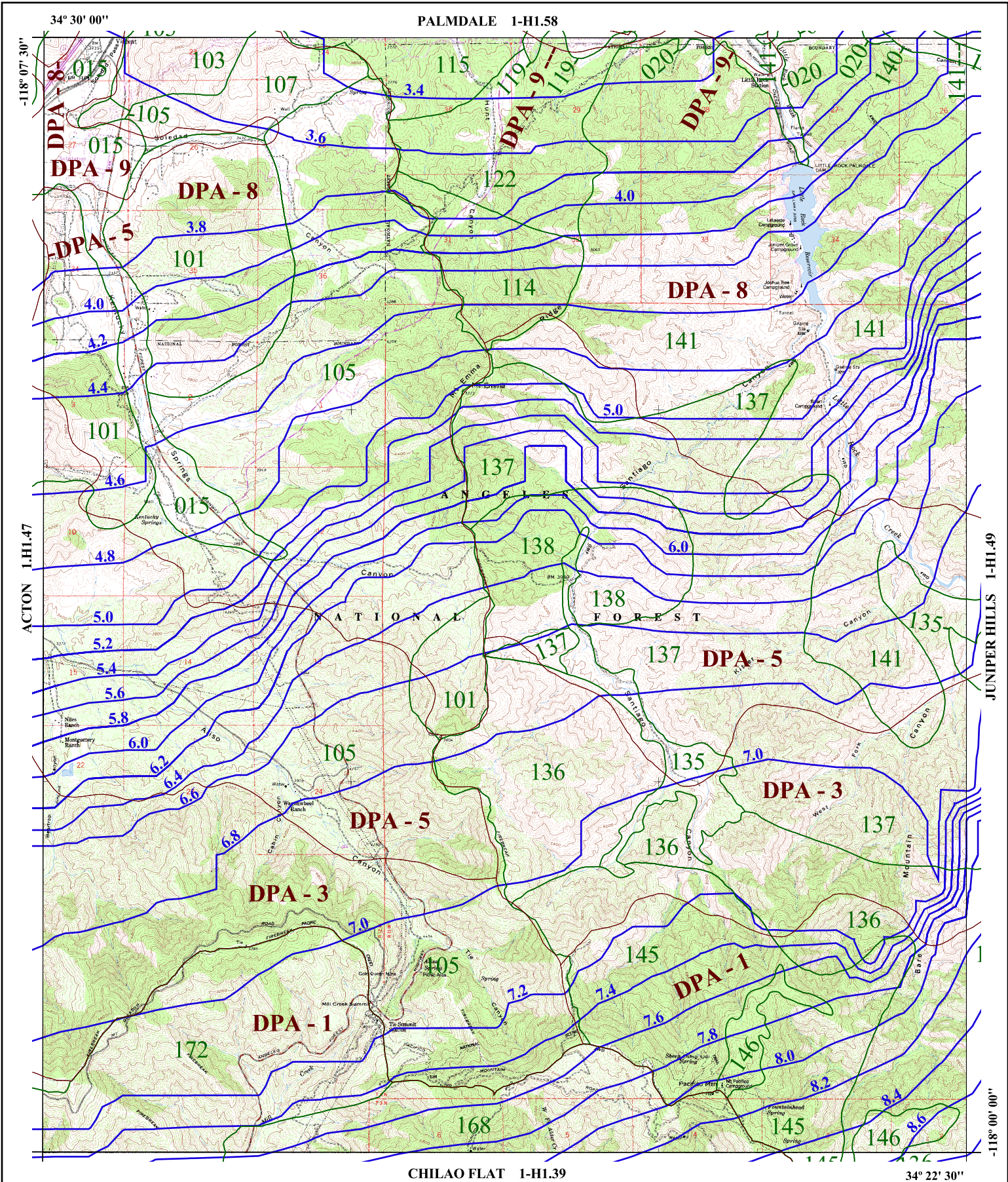

- 016 SOIL CLASSIFICATION AREA
- 7.2 INCHES OF RAINFALL
- DPA - 6 DEBRIS POTENTIAL AREA



25-YEAR 24-HOUR ISOHYET REDUCTION FACTOR: 0.878
 10-YEAR 24-HOUR ISOHYET REDUCTION FACTOR: 0.714

PACIFICO MOUNTAIN 50-YEAR 24-HOUR ISOHYET

1-HI.48



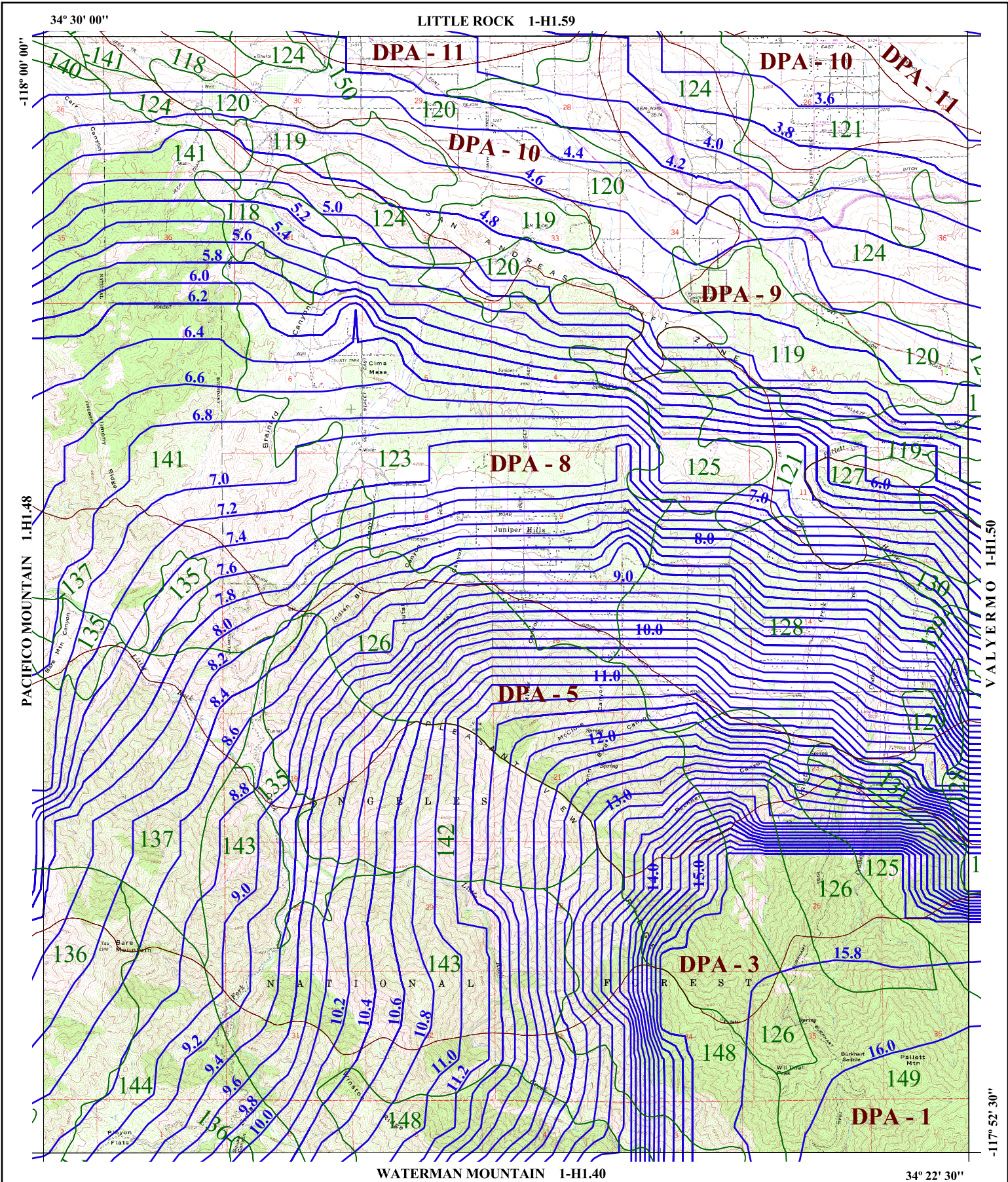

016 SOIL CLASSIFICATION AREA

7.2 INCHES OF RAINFALL

DPA - 6 DEBRIS POTENTIAL AREA



25-YEAR 24-HOUR ISOHYET REDUCTION FACTOR: 0.878
 10-YEAR 24-HOUR ISOHYET REDUCTION FACTOR: 0.714

JUNIPER HILLS

50-YEAR 24-HOUR ISOHYET

1-H1.49



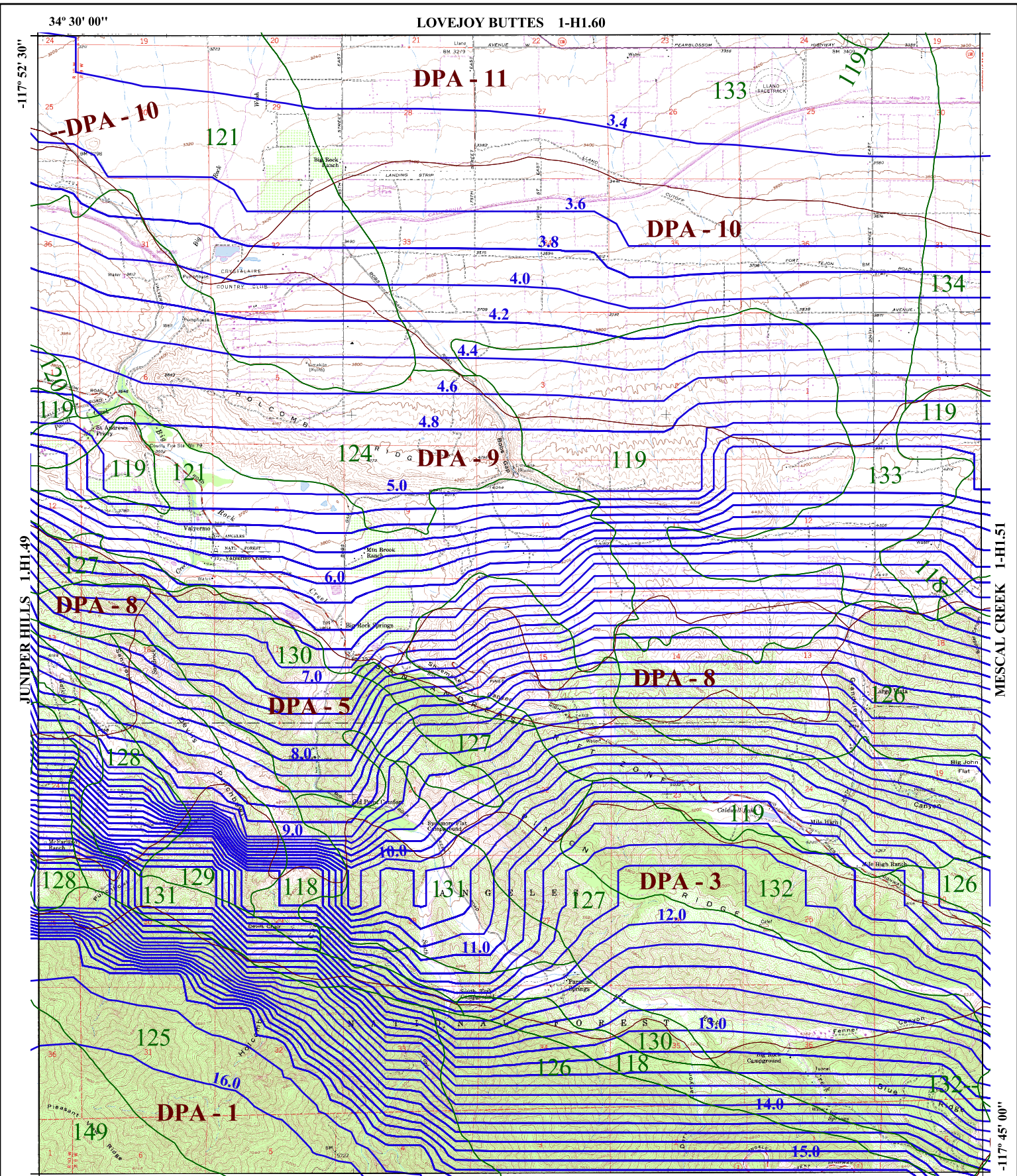



016 SOIL CLASSIFICATION AREA

7.2 INCHES OF RAINFALL

DPA - 6 DEBRIS POTENTIAL AREA

1 0 1 2 Miles

 25-YEAR 24-HOUR ISOHYET REDUCTION FACTOR: 0.878

 10-YEAR 24-HOUR ISOHYET REDUCTION FACTOR: 0.714

V A L Y E R M O

1-H1.50

50-YEAR 24-HOUR ISOHYET



34° 30' 00"

EL MIRAGE 1-H1.61

-117° 45' 00"

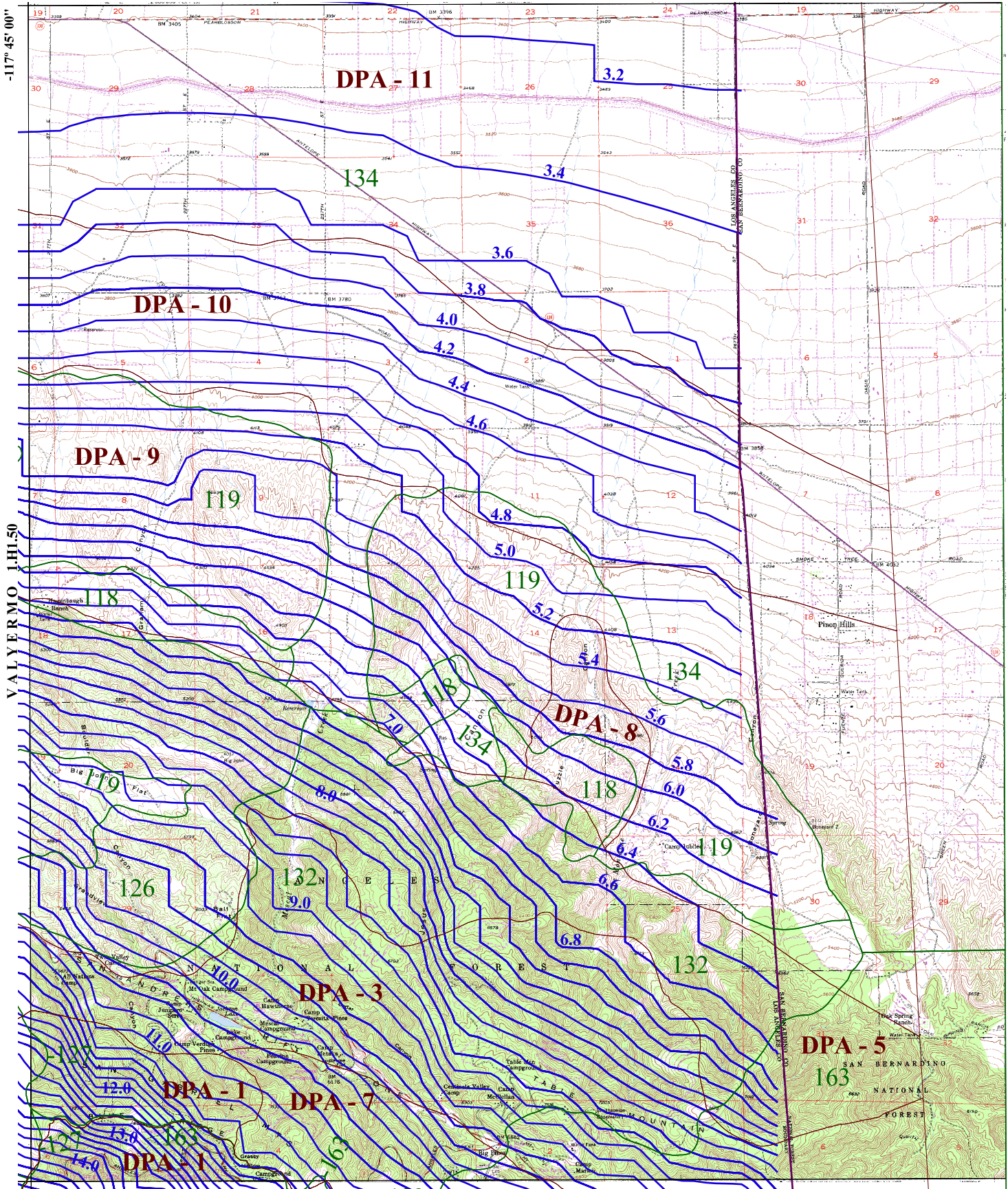

VALLEY MO 1-H1.50

PHELAN 1-H1.51A

-117° 37' 30"

MOUNT SAN ANTONIO 1-H1.42

34° 22' 30"



- 016 SOIL CLASSIFICATION AREA
- 7.2 INCHES OF RAINFALL
- DPA - 6 DEBRIS POTENTIAL AREA

1 0 1 2 Miles

25-YEAR 24-HOUR ISOHYET REDUCTION FACTOR: 0.878
10-YEAR 24-HOUR ISOHYET REDUCTION FACTOR: 0.714

MESCAL CREEK 50-YEAR 24-HOUR ISOHYET

1-H1.51



34° 37' 30"

BLACK MOUNTAIN 1-H1.62

-118° 52' 30"

DEVILS HEART PEAK

WHITAKER PEAK 1-H1.53

-118° 45' 00"

PIRU

34° 30' 00"



016

SOIL CLASSIFICATION AREA

7.2

INCHES OF RAINFALL

DPA - 6

DEBRIS POTENTIAL AREA

1 0 1 2 Miles

25-YEAR 24-HOUR ISOHYET REDUCTION FACTOR: 0.878
10-YEAR 24-HOUR ISOHYET REDUCTION FACTOR: 0.714

COBBLESTONE 50-YEAR 24-HOUR ISOHYET

1-H1.52

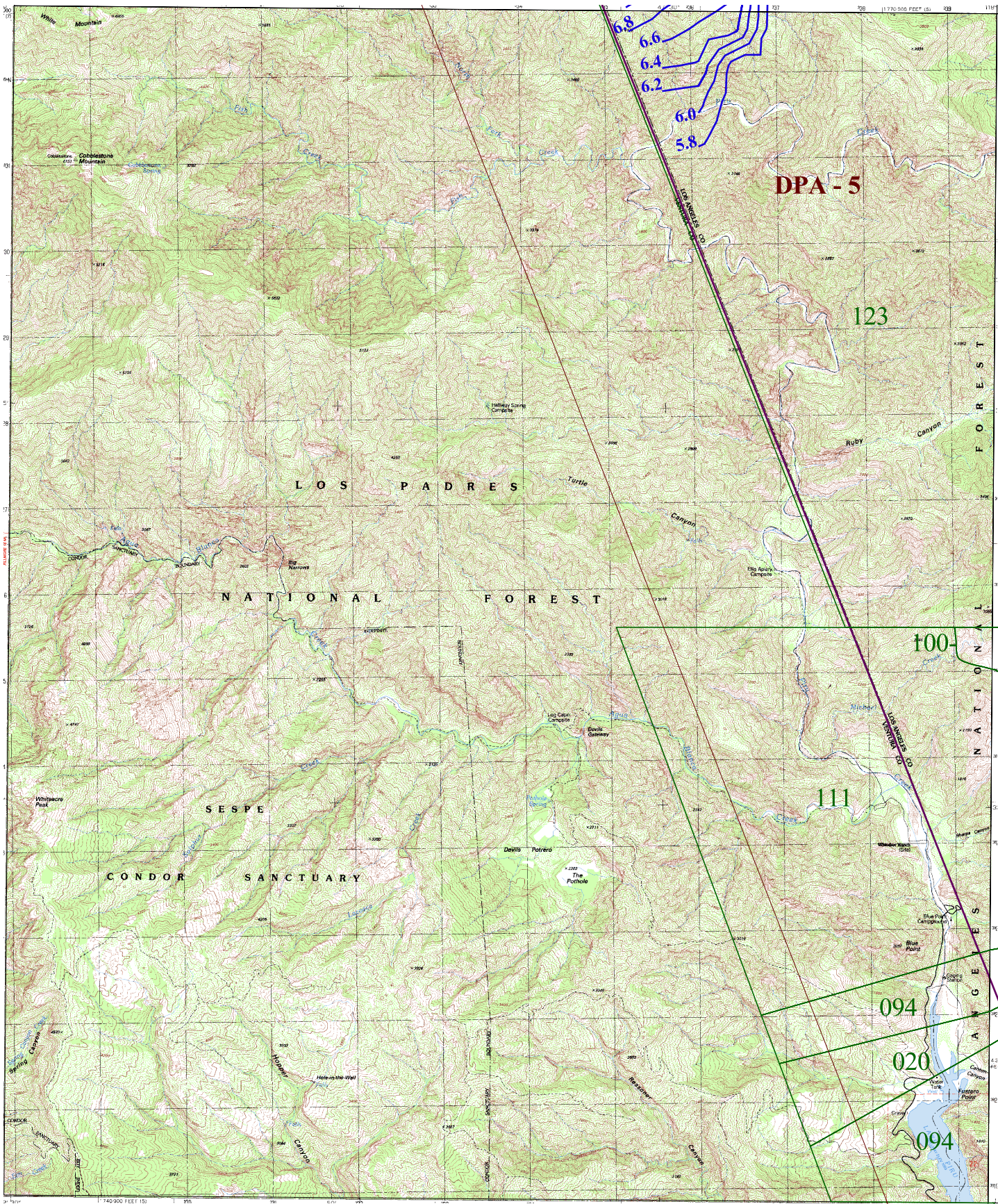

34° 37' 30"

LIEBRE MOUNTAIN 1-HI.63

-118° 45' 00"

COBBLESTONE 1-HI.52

WARM SPRINGS MOUNTAIN 1-HI.54

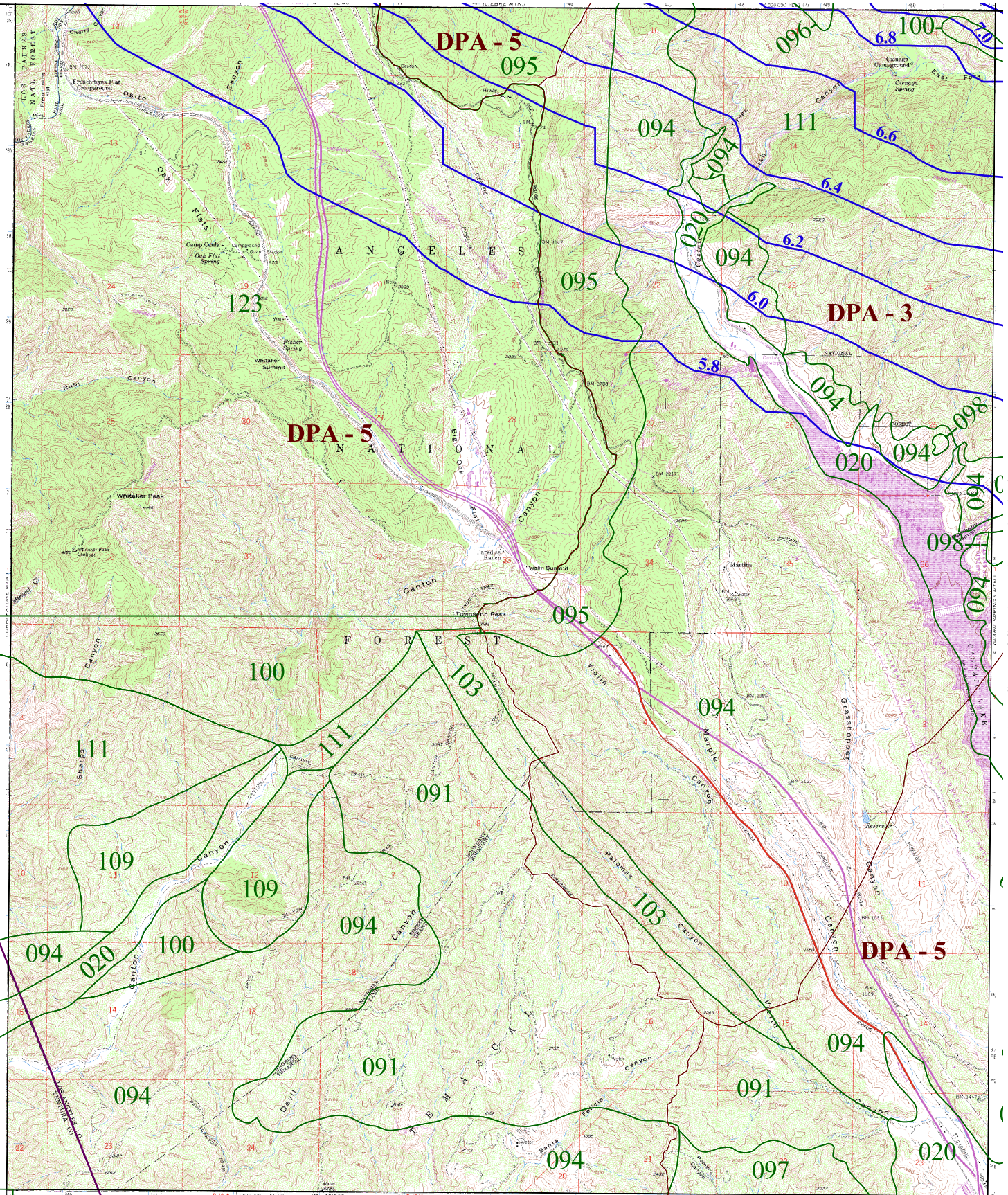

-118° 37' 30"

VAL VERDE 1-HI.43

34° 30' 00"



016

SOIL CLASSIFICATION AREA

7.2

INCHES OF RAINFALL

DPA - 6

DEBRIS POTENTIAL AREA

1 0 1 2 Miles

25-YEAR 24-HOUR ISOHYET REDUCTION FACTOR: 0.878
10-YEAR 24-HOUR ISOHYET REDUCTION FACTOR: 0.714

WHITAKER PEAK 50-YEAR 24-HOUR ISOHYET

1-HI.53



34° 37' 30"

BURNT PEAK 1-H1.64

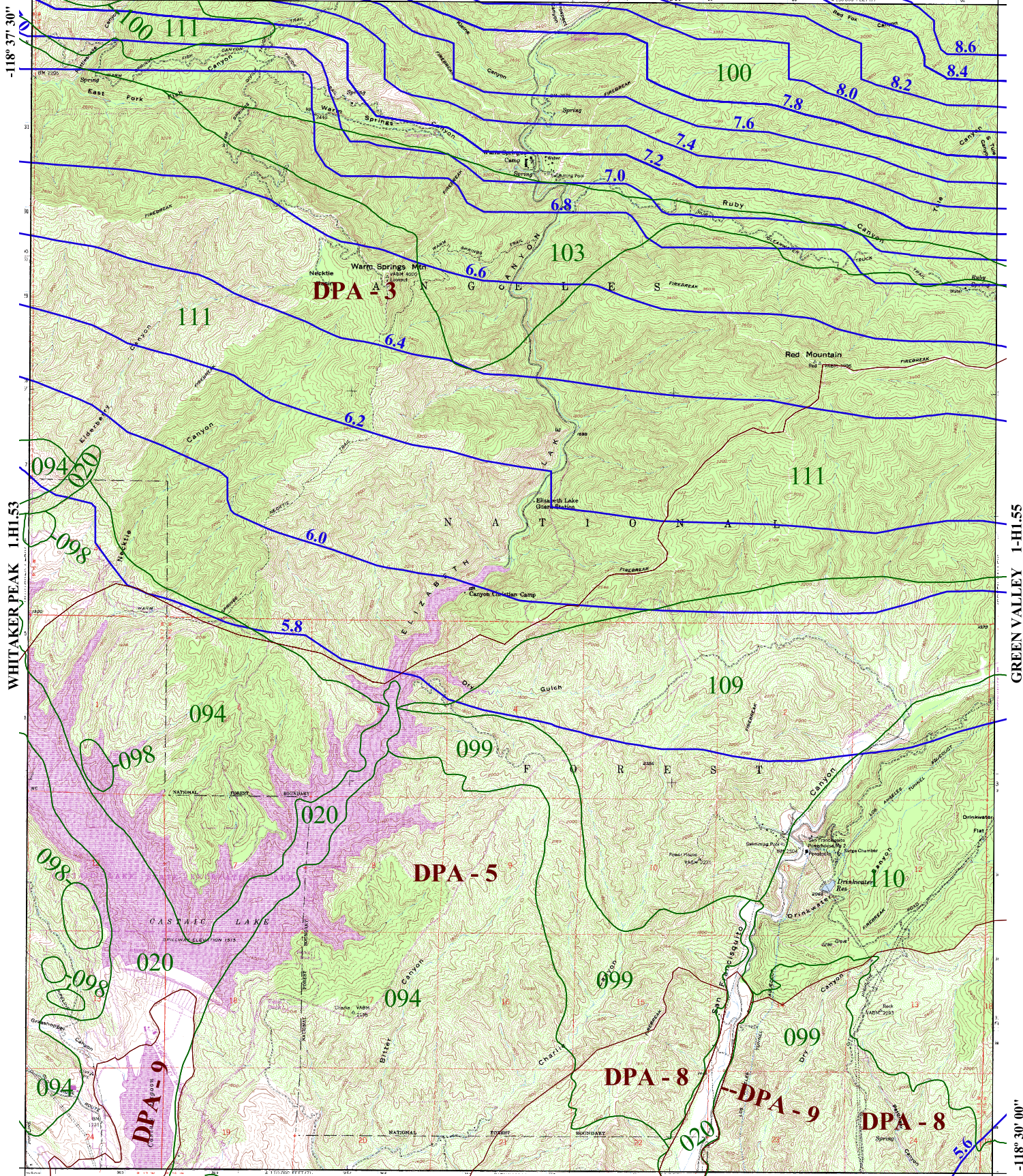

WHITAKER PEAK 1-H1.53

GREEN VALLEY 1-H1.55

NEWHALL 1-H1.44

34° 30' 00"



016

SOIL CLASSIFICATION AREA

7.2

INCHES OF RAINFALL

DPA - 6

DEBRIS POTENTIAL AREA

1 0 1 2 Miles

25-YEAR 24-HOUR ISOHYET REDUCTION FACTOR: 0.878
10-YEAR 24-HOUR ISOHYET REDUCTION FACTOR: 0.714

WARM SPRINGS MOUNTAIN 50-YEAR 24-HOUR ISOHYET

1-H1.54



34° 37' 30"

LAKE HUGHES 1-HI.64

-118° 30' 00"

WARM SPRINGS MOUNTAIN 1-HI.54

SLEEPY VALLEY 1-HI.56

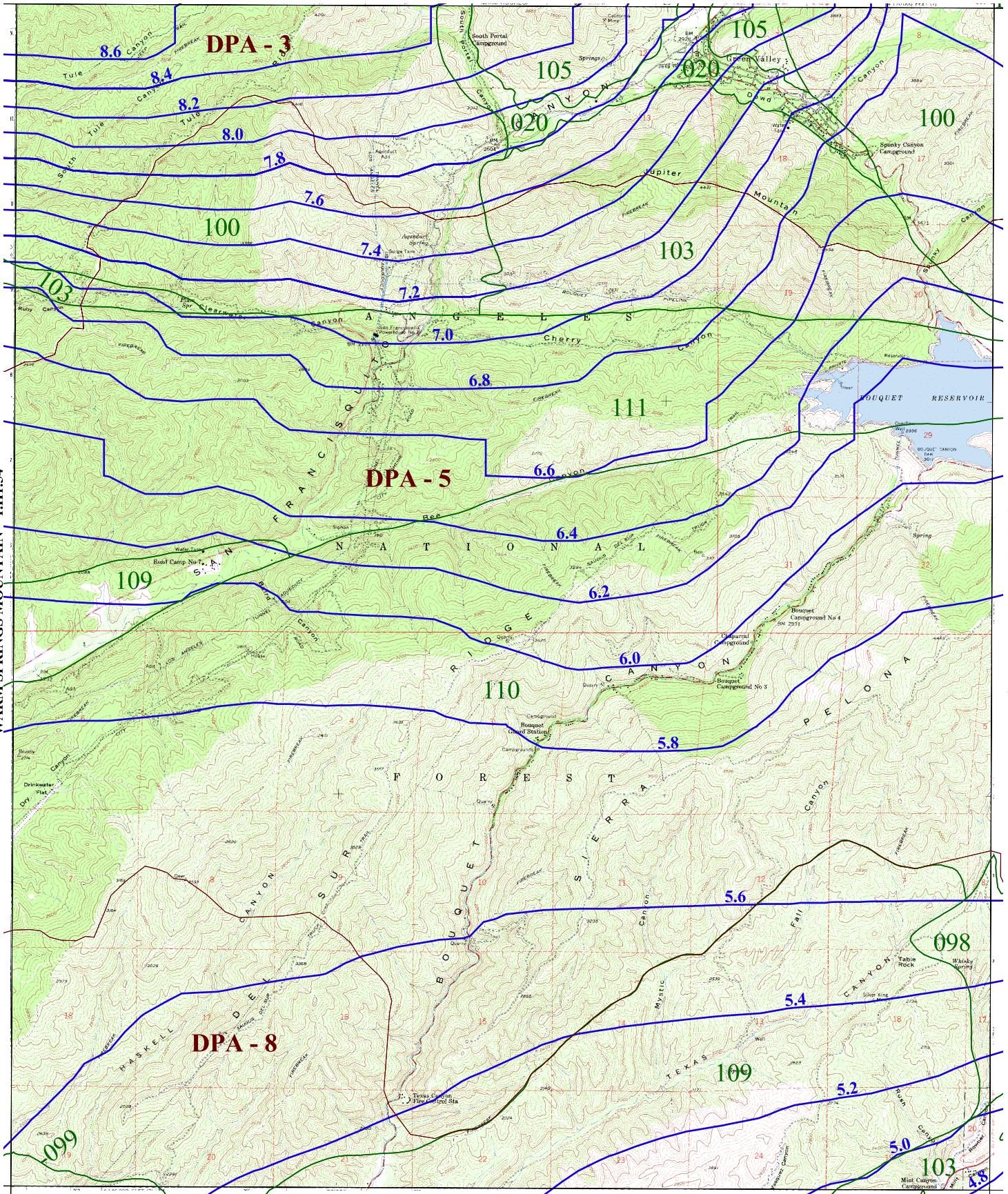

MINT CANYON 1-HI.45

34° 30' 00"

-118° 22' 30"



016 SOIL CLASSIFICATION AREA

7.2 INCHES OF RAINFALL

DPA - 6 DEBRIS POTENTIAL AREA

1 0 1 2 Miles

25-YEAR 24-HOUR ISOHYET REDUCTION FACTOR: 0.878
10-YEAR 24-HOUR ISOHYET REDUCTION FACTOR: 0.714

GREEN VALLEY 50-YEAR 24-HOUR ISOHYET

1-HI.55



34° 37' 30"

DEL SUR 1-HI.66

-118° 22' 30"

GREEN VALLEY 1-HI.55

RITTER RIDGE 1-HI.57

-118° 15' 00"

AGUA DULCE 1-HI.46

34° 30' 00"

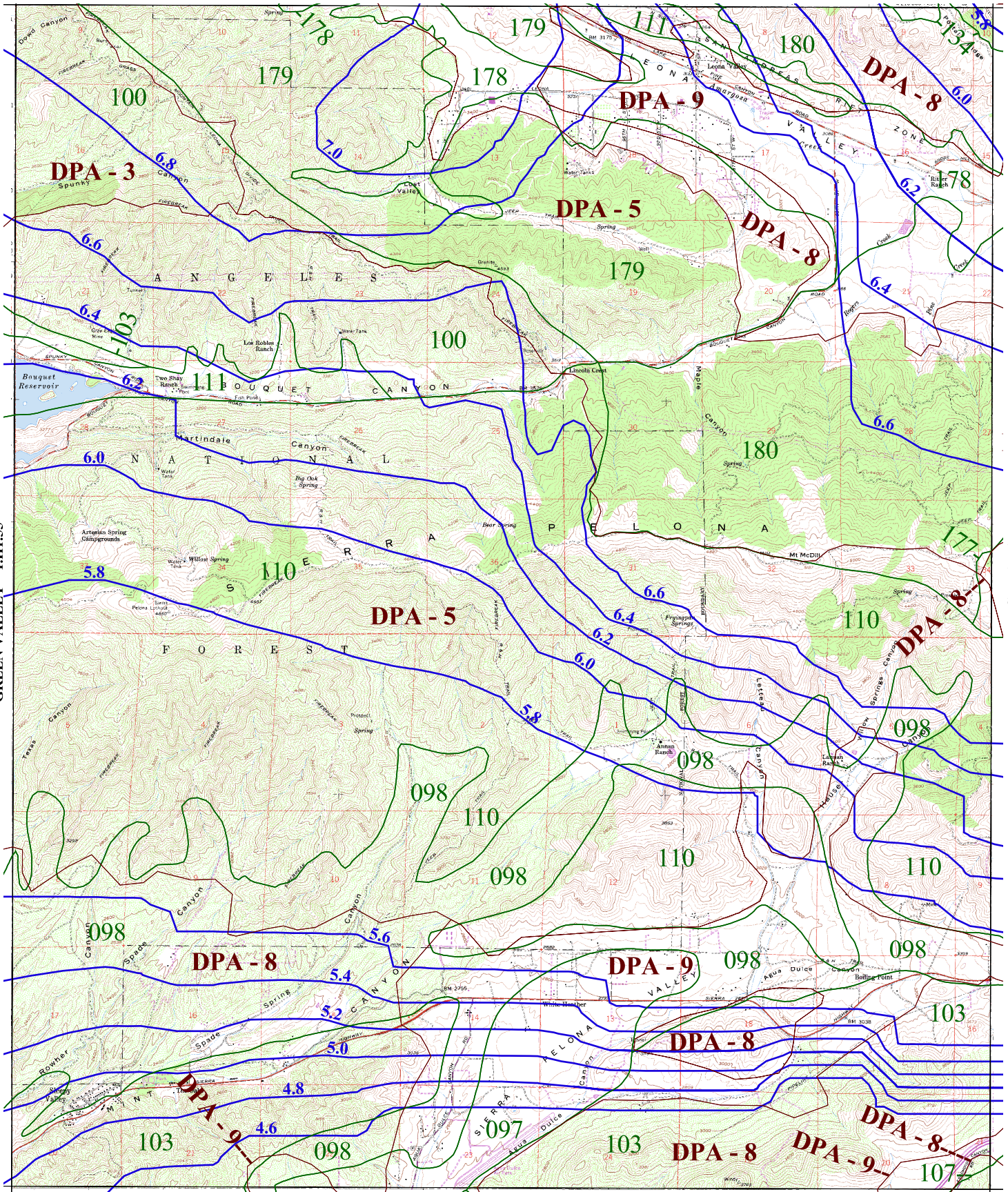

- 016 SOIL CLASSIFICATION AREA
- 7.2 INCHES OF RAINFALL
- DPA - 6 DEBRIS POTENTIAL AREA



25-YEAR 24-HOUR ISOHYET REDUCTION FACTOR: 0.878
 10-YEAR 24-HOUR ISOHYET REDUCTION FACTOR: 0.714

SLEEPY VALLEY 50-YEAR 24-HOUR ISOHYET

1-HI.56



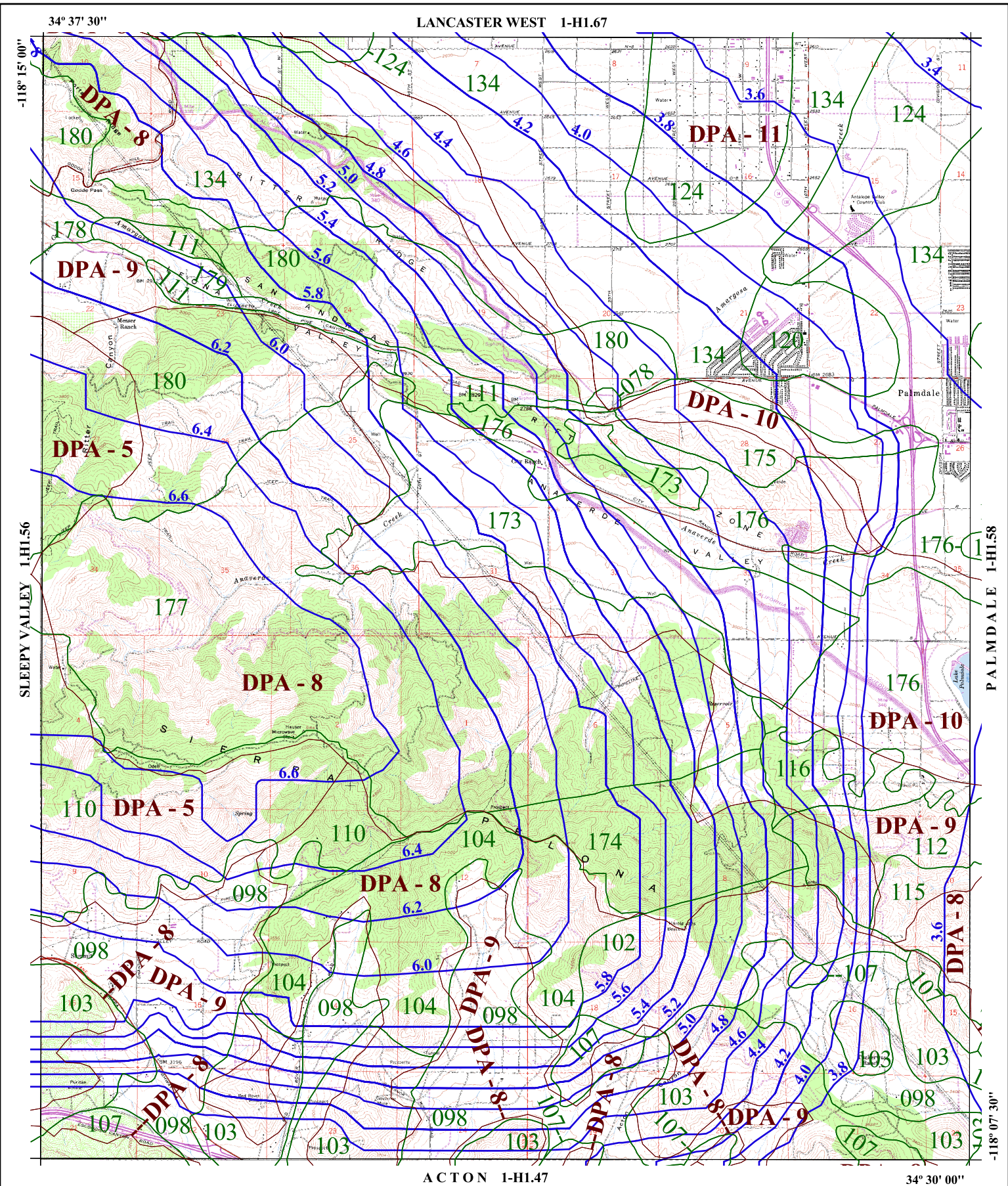

LANCASTER WEST 1-HI.67

34° 37' 30"

-118° 15' 00"

SLEEPY VALLEY 1-HI.56

PALMDALE 1-HI.58

ACTON 1-HI.47

34° 30' 00"

-118° 07' 30"



016 SOIL CLASSIFICATION AREA

7.2 INCHES OF RAINFALL

DPA - 6 DEBRIS POTENTIAL AREA

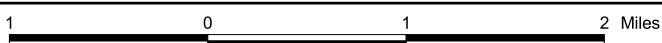

25-YEAR 24-HOUR ISOHYET REDUCTION FACTOR: 0.878
 10-YEAR 24-HOUR ISOHYET REDUCTION FACTOR: 0.714

RITTER RIDGE 50-YEAR 24-HOUR ISOHYET

1-HI.57



34° 37' 30"

LANCASTER EAST 1-H1.68

-118° 07' 30"

RITTER RIDGE 1-H1.57

LITTLE ROCK 1-H1.59

-118° 00' 00"

PACIFICO MOUNTAIN 1-H1.48

34° 30' 00"

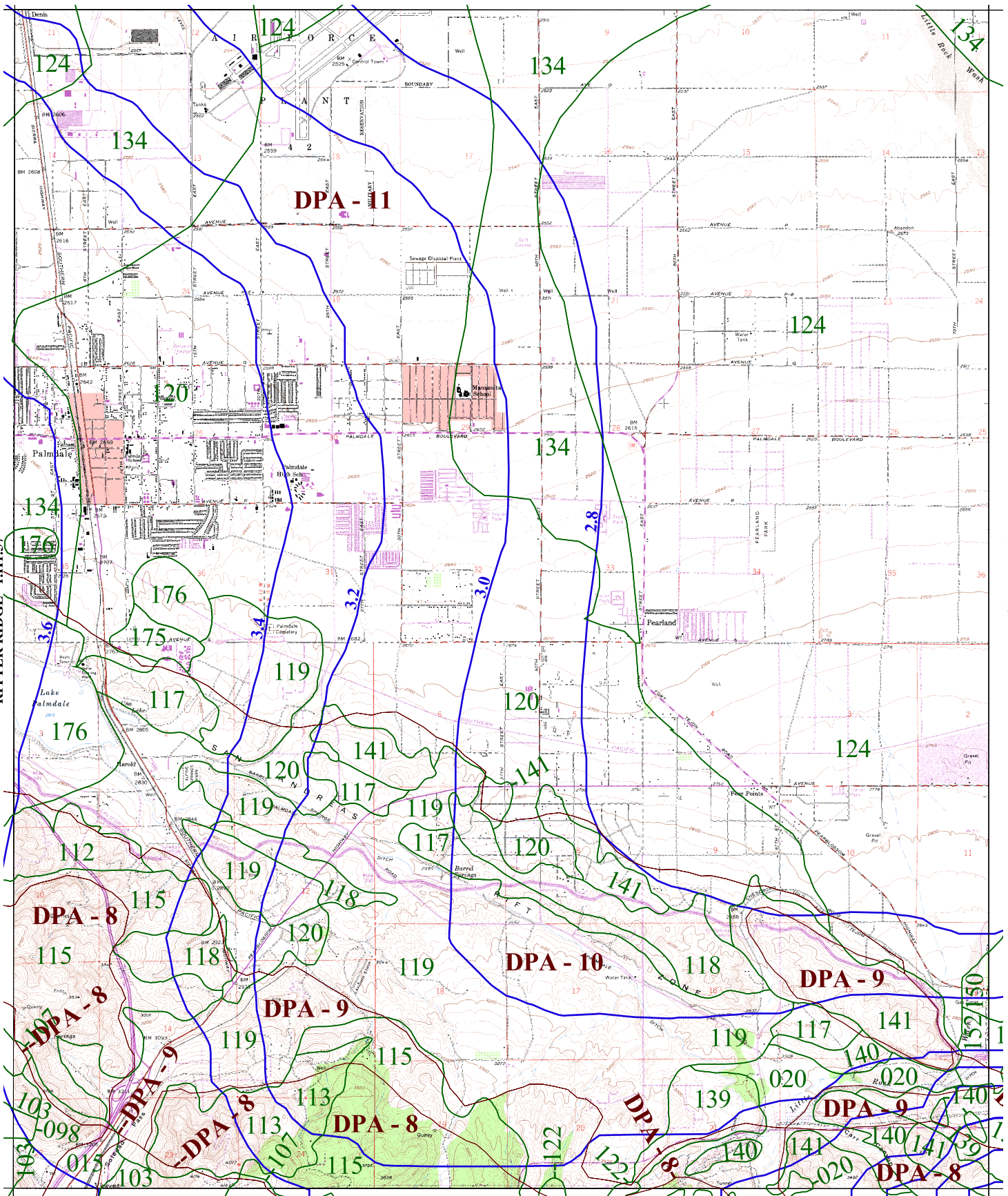

016 SOIL CLASSIFICATION AREA

7.2 INCHES OF RAINFALL

DPA - 6 DEBRIS POTENTIAL AREA



25-YEAR 24-HOUR ISOHYET REDUCTION FACTOR: 0.878
 10-YEAR 24-HOUR ISOHYET REDUCTION FACTOR: 0.714

PALMDALE

50-YEAR 24-HOUR ISOHYET

1-H1.58



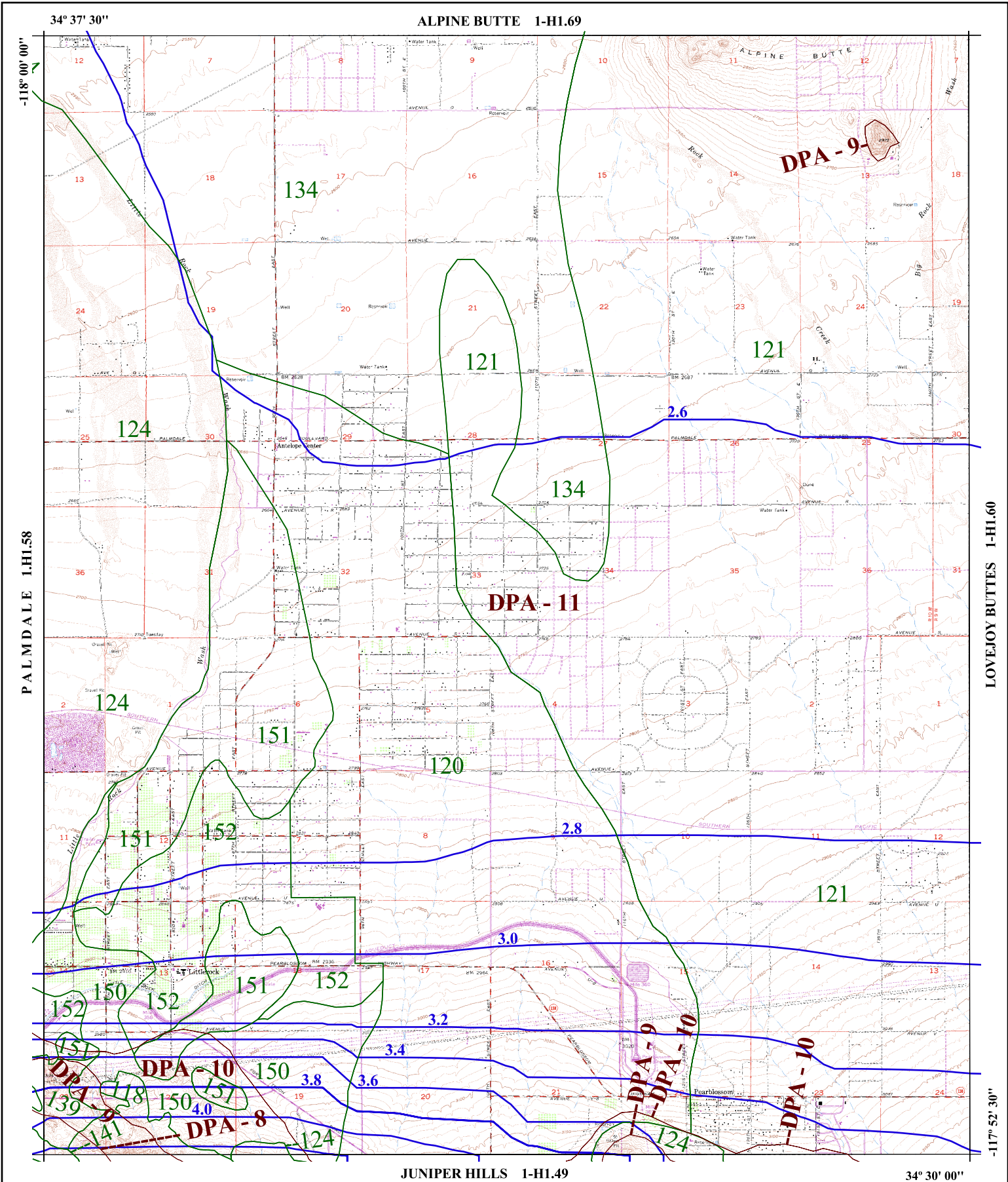

ALPINE BUTTE 1-HI.69

PALMDALE 1-HI.58

LOVEJOY BUTTES 1-HI.60

JUNIPER HILLS 1-HI.49

34° 30' 00"



016 SOIL CLASSIFICATION AREA

7.2 INCHES OF RAINFALL

DPA - 6 DEBRIS POTENTIAL AREA

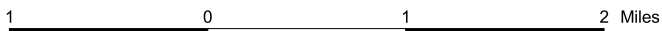

25-YEAR 24-HOUR ISOHYET REDUCTION FACTOR: 0.878
 10-YEAR 24-HOUR ISOHYET REDUCTION FACTOR: 0.714

LITTLE ROCK
50-YEAR 24-HOUR ISOHYET

1-HI.59



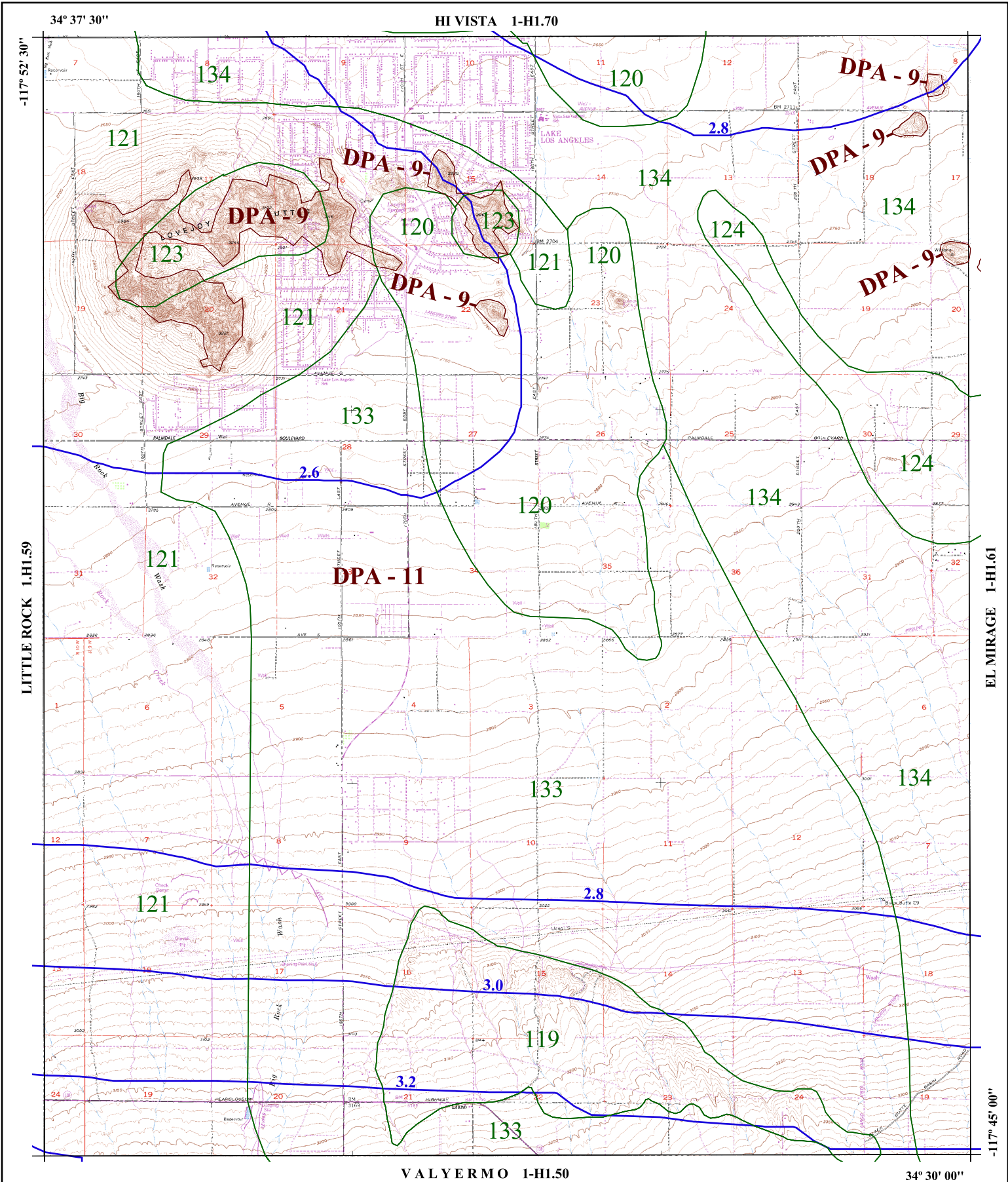

34° 37' 30"

HI VISTA 1-HI.70

-117° 52' 30"

LITTLE ROCK 1-HI.59

EL MIRAGE 1-HI.61

-117° 45' 00"

VALYERMO 1-HI.50

34° 30' 00"



016

SOIL CLASSIFICATION AREA

7.2

INCHES OF RAINFALL

DPA - 6

DEBRIS POTENTIAL AREA

1 0 1 2 Miles

25-YEAR 24-HOUR ISOHYET REDUCTION FACTOR: 0.878
 10-YEAR 24-HOUR ISOHYET REDUCTION FACTOR: 0.714

LOVEJOY BUTTES
50-YEAR 24-HOUR ISOHYET

1-HI.60



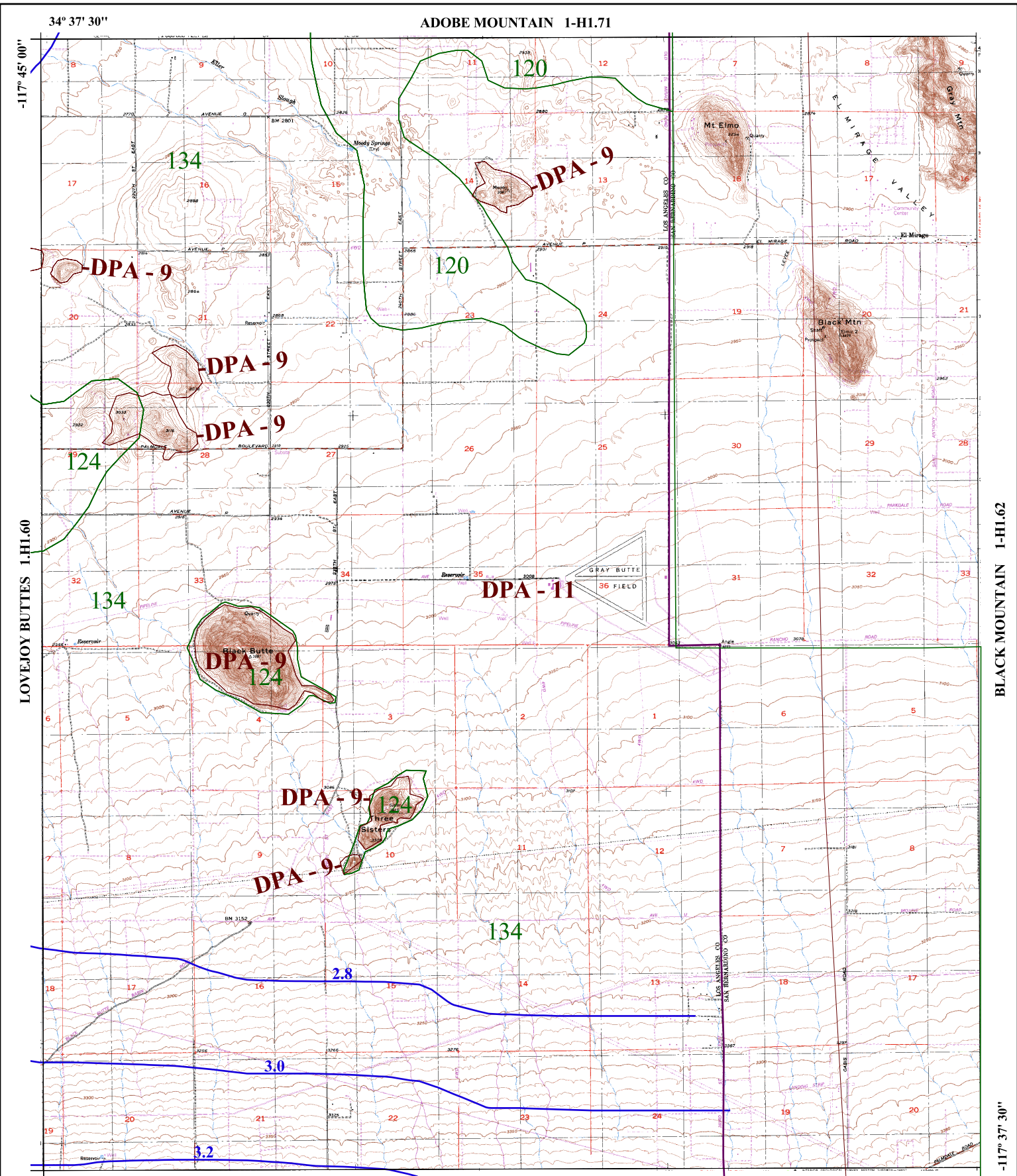

016

SOIL CLASSIFICATION AREA

7.2

INCHES OF RAINFALL

DPA - 6

DEBRIS POTENTIAL AREA



25-YEAR 24-HOUR ISOHYET REDUCTION FACTOR: 0.878
 10-YEAR 24-HOUR ISOHYET REDUCTION FACTOR: 0.714

EL MIRAGE
50-YEAR 24-HOUR ISOHYET

1-H1.61



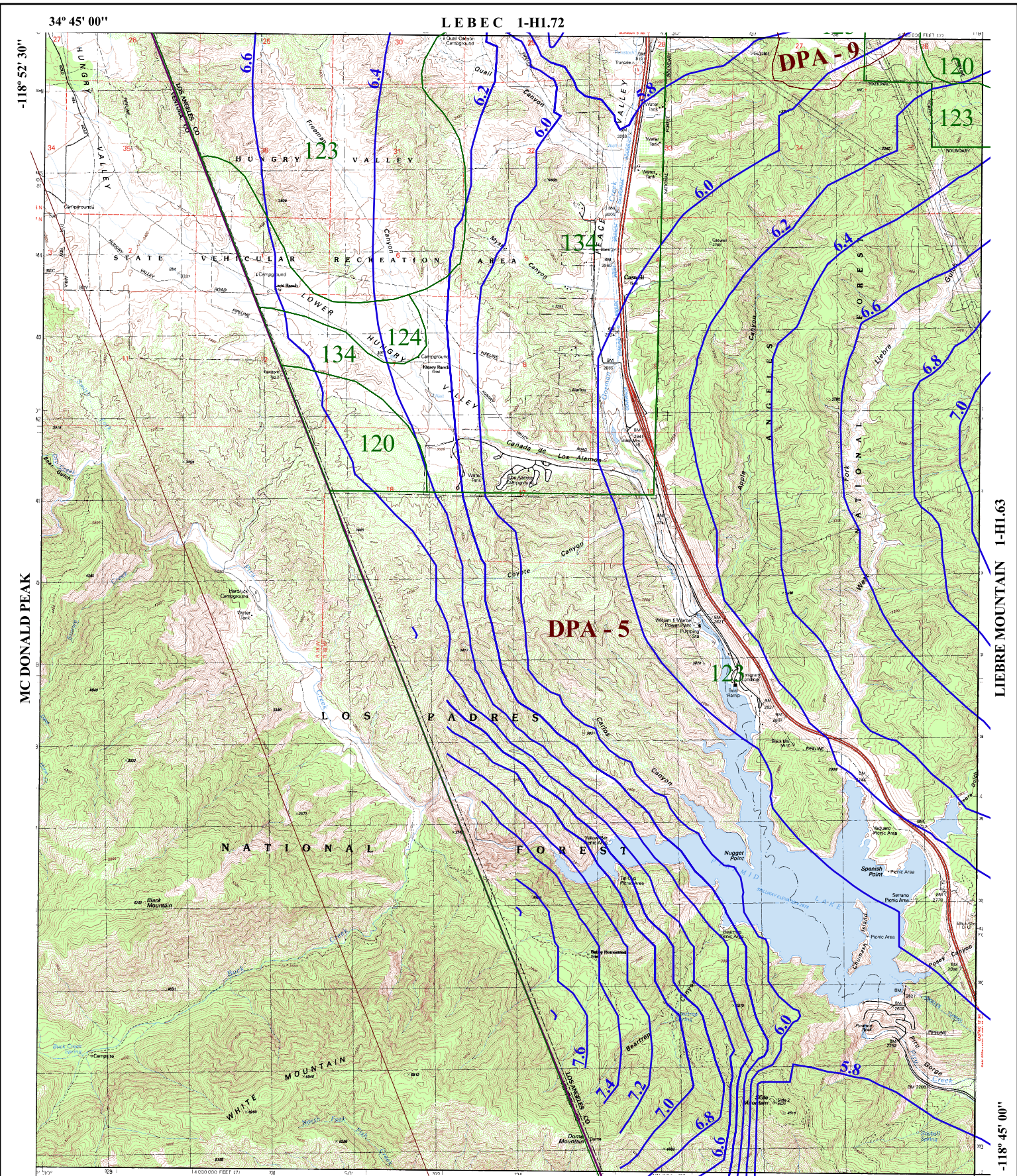

MC DONALD PEAK

LIEBRE MOUNTAIN 1-HI.63

34° 45' 00"

-118° 52' 30"

LEBEC 1-HI.72

HUNGRY VALLEY

STATE VEHICULAR RECREATION AREA

LOWER HUNGRY VALLEY

LOS PADRES NATIONAL FOREST

COBBLESTONE 1-HI.52

34° 37' 30"

-118° 45' 00"

016 SOIL CLASSIFICATION AREA

7.2 INCHES OF RAINFALL

DPA - 6 DEBRIS POTENTIAL AREA

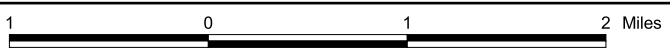

25-YEAR 24-HOUR ISOHYET REDUCTION FACTOR: 0.878
 10-YEAR 24-HOUR ISOHYET REDUCTION FACTOR: 0.714

BLACK MOUNTAIN
50-YEAR 24-HOUR ISOHYET

1-HI.62



34° 45' 00"

LA LIEBRE RANCH 1-HI.73

-118° 45' 00"

BLACK MOUNTAIN 1-HI.62

BURNT PEAK 1-HI.64

-118° 37' 30"

WHITAKER PEAK 1-HI.53

34° 37' 30"

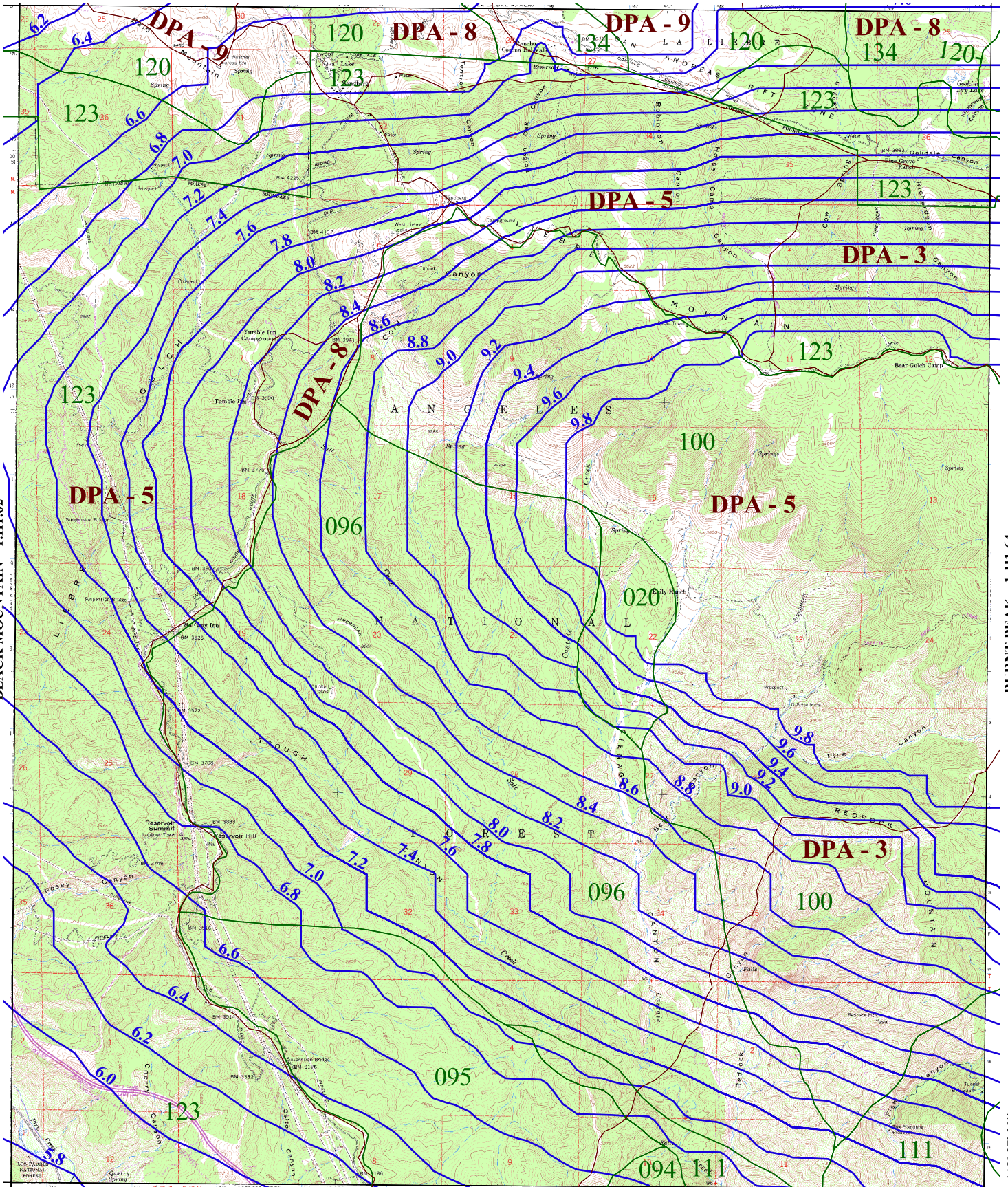

016 SOIL CLASSIFICATION AREA

7.2 INCHES OF RAINFALL

DPA - 6 DEBRIS POTENTIAL AREA

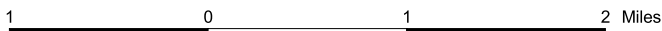

25-YEAR 24-HOUR ISOHYET REDUCTION FACTOR: 0.878
 10-YEAR 24-HOUR ISOHYET REDUCTION FACTOR: 0.714

LIEBRE MOUNTAIN 50-YEAR 24-HOUR ISOHYET

1-HI.63



34° 45' 00"

NEENACH SCHOOL 1-HI.74

-118° 37' 30"

LIEBRE MOUNTAIN 1-HI.63

LAKE HUGHES 1-HI.65

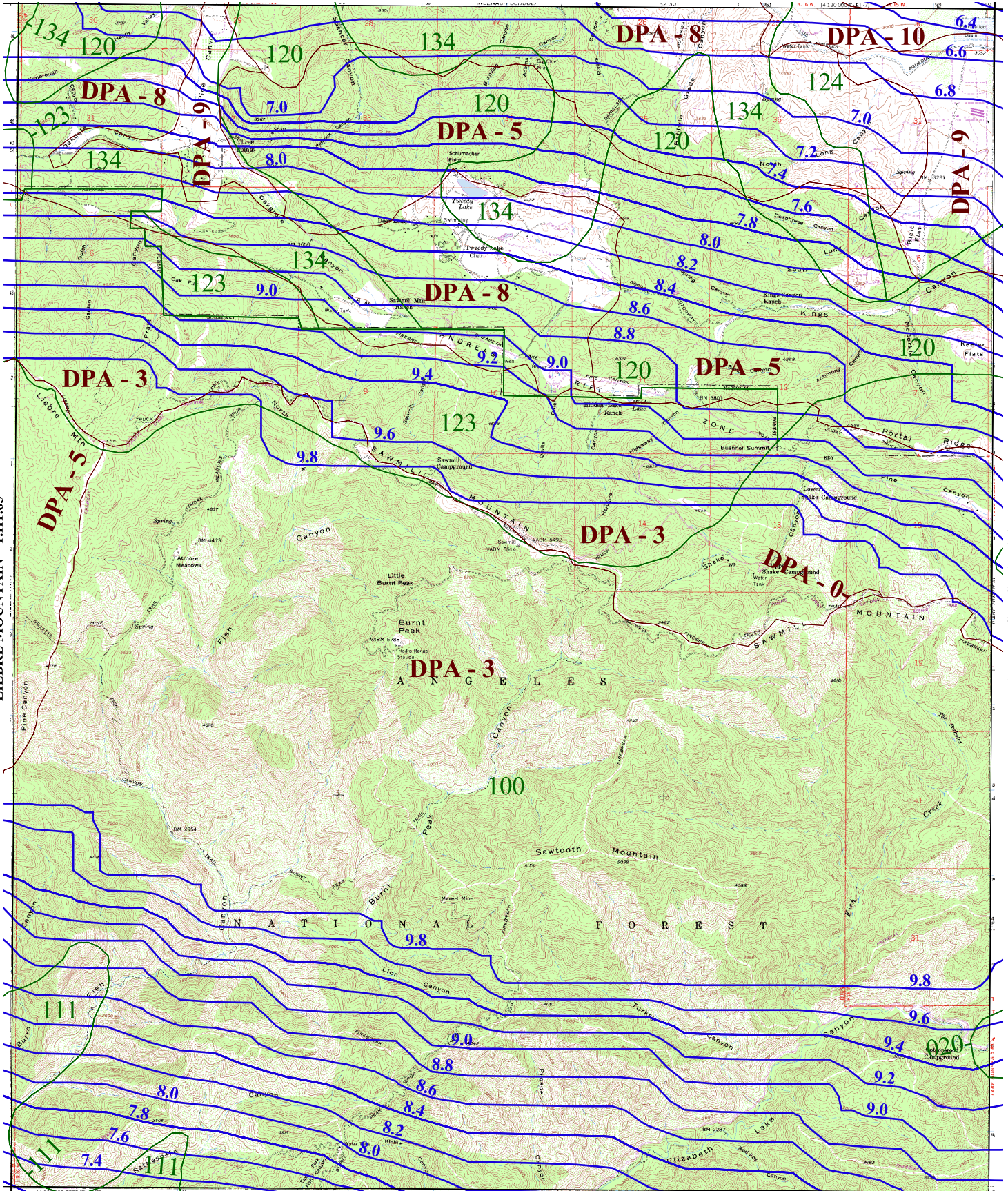

-118° 30' 00"

WARM SPRINGS MOUNTAIN 1-HI.54

34° 37' 30"



016

SOIL CLASSIFICATION AREA

7.2

INCHES OF RAINFALL

DPA - 6

DEBRIS POTENTIAL AREA

1 0 1 2 Miles

25-YEAR 24-HOUR ISOHYET REDUCTION FACTOR: 0.878
10-YEAR 24-HOUR ISOHYET REDUCTION FACTOR: 0.714

BURNT PEAK 50-YEAR 24-HOUR ISOHYET

1-HI.64



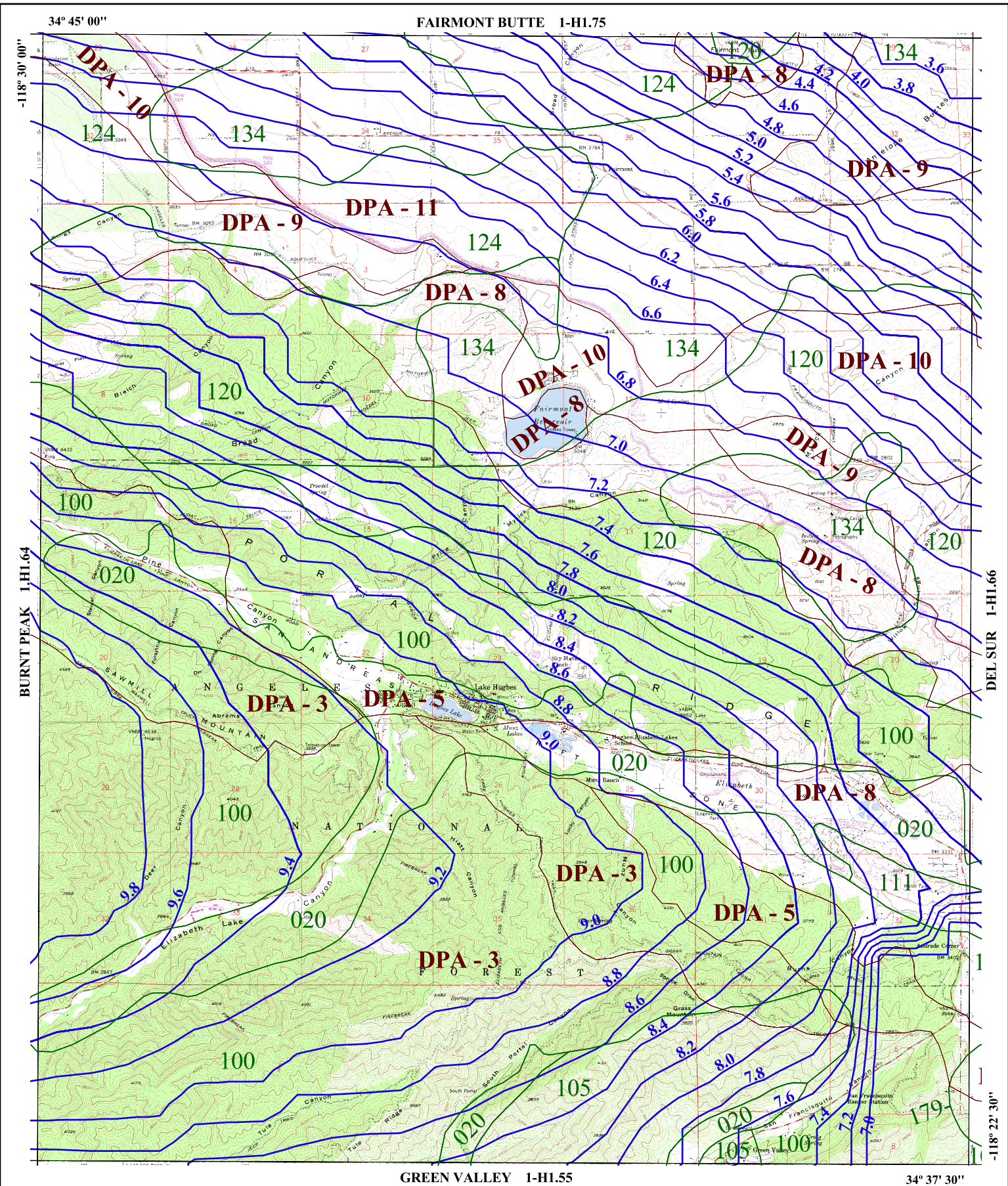

016 SOIL CLASSIFICATION AREA

 7.2 INCHES OF RAINFALL

DPA - 6 DEBRIS POTENTIAL AREA

1 0 1 2 Miles

 25-YEAR 24-HOUR ISOHYET REDUCTION FACTOR: 0.878

 10-YEAR 24-HOUR ISOHYET REDUCTION FACTOR: 0.714

LAKE HUGHES

50-YEAR 24-HOUR ISOHYET

34° 37' 30"

1-H1.65

 LOS ANGELES COUNTY

 PUBLIC WORKS

 Public Service That Works

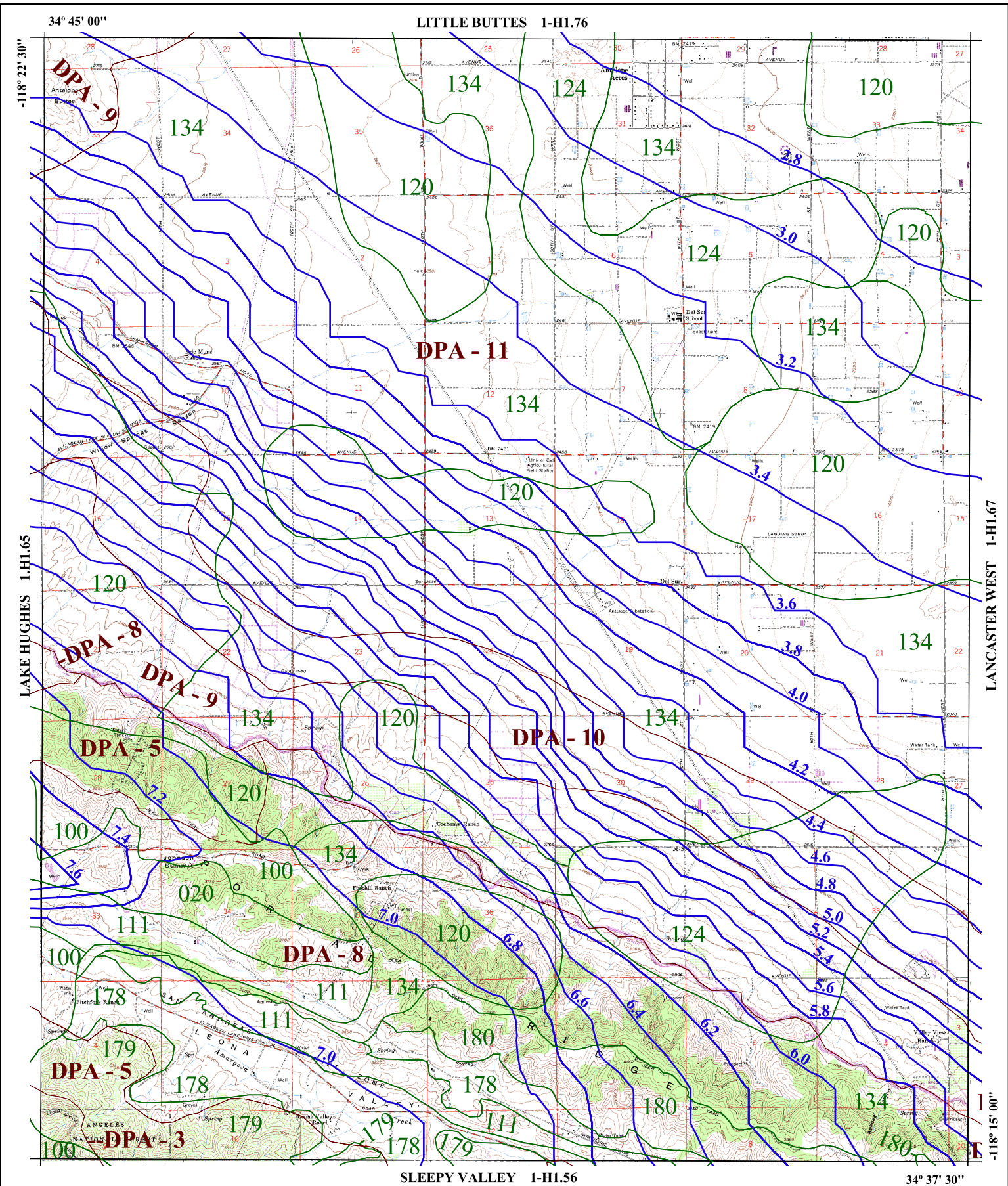

- 016 SOIL CLASSIFICATION AREA
- 7.2 INCHES OF RAINFALL
- DPA - 6 DEBRIS POTENTIAL AREA

1 0 1 2 Miles

25-YEAR 24-HOUR ISOHYET REDUCTION FACTOR: 0.878
 10-YEAR 24-HOUR ISOHYET REDUCTION FACTOR: 0.714

DEL SUR

50-YEAR 24-HOUR ISOHYET

1-HI.66



34° 45' 00"

ROSAMOND I-HI.77

-118° 15' 00"

DEL SUR I-HI.66

LANCASTER EAST I-HI.68

-118° 07' 30"

RITTER RIDGE I-HI.57

34° 37' 30"

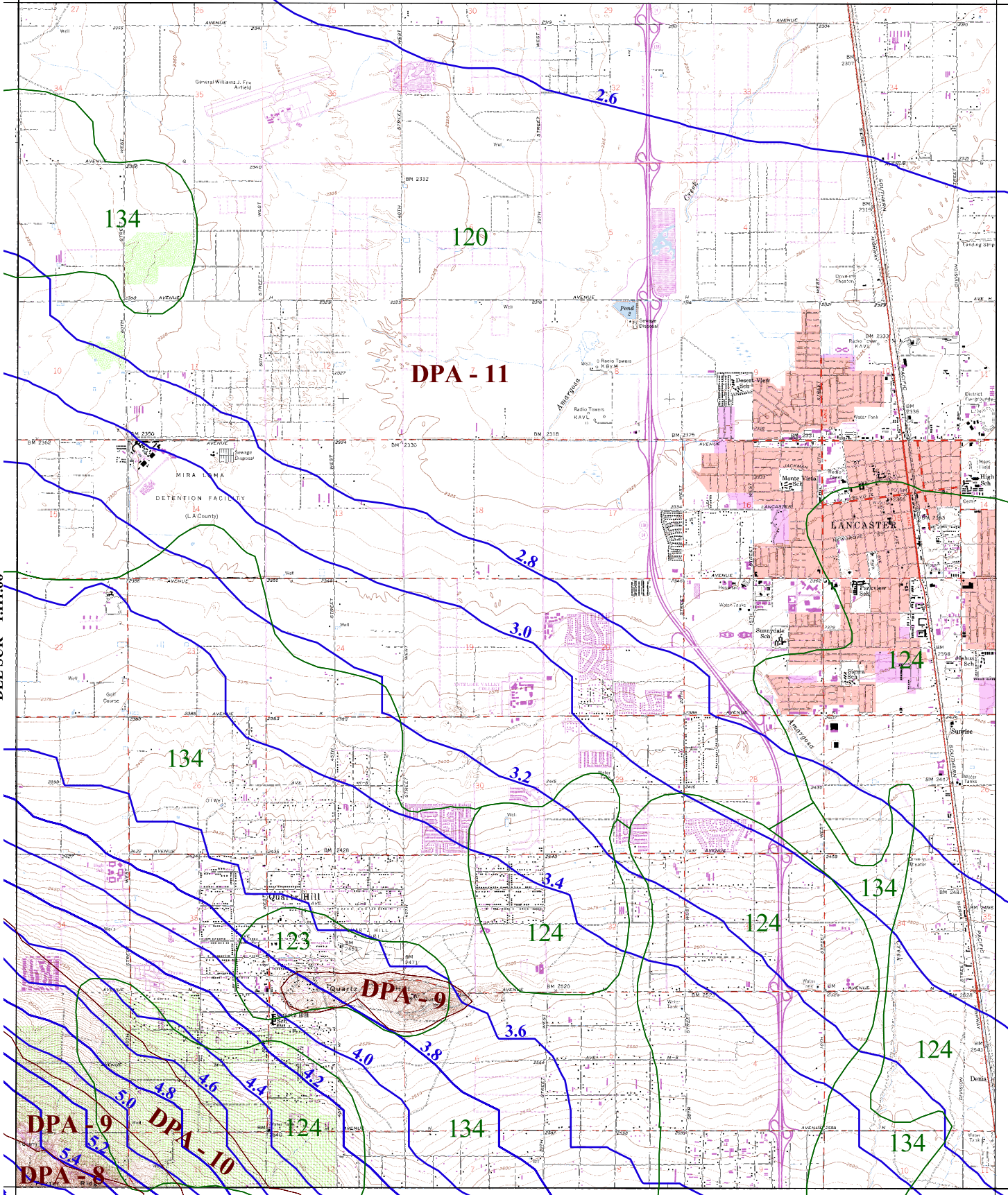

- 016 SOIL CLASSIFICATION AREA
- 7.2 INCHES OF RAINFALL
- DPA - 6 DEBRIS POTENTIAL AREA

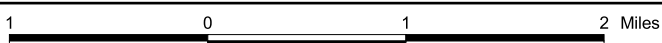

25-YEAR 24-HOUR ISOHYET REDUCTION FACTOR: 0.878
 10-YEAR 24-HOUR ISOHYET REDUCTION FACTOR: 0.714

LANCASTER WEST 50-YEAR 24-HOUR ISOHYET

1-HI.67



34° 45' 00"

ROSAMOND LAKE 1-HI.78

-118° 07' 30"

LANCASTER WEST 1-HI.67

ALPINE BUTTE 1-HI.69

-118° 00' 00"

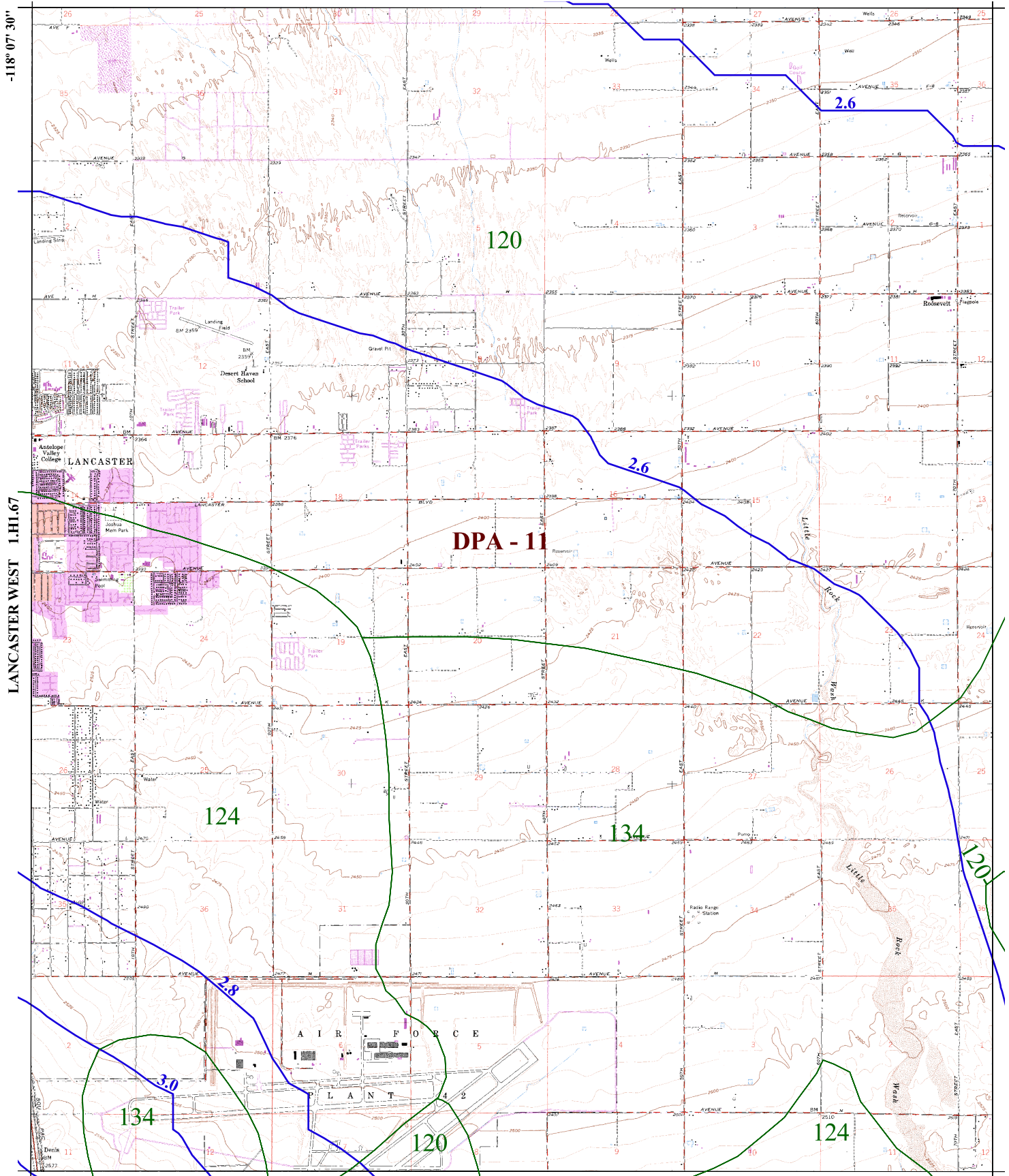

PALMDALE 1-HI.58

34° 37' 30"



016

SOIL CLASSIFICATION AREA

7.2

INCHES OF RAINFALL

DPA - 6

DEBRIS POTENTIAL AREA

1 0 1 2 Miles

25-YEAR 24-HOUR ISOHYET REDUCTION FACTOR: 0.878
10-YEAR 24-HOUR ISOHYET REDUCTION FACTOR: 0.714

LANCASTER EAST 50-YEAR 24-HOUR ISOHYET

1-HI.68



34° 45' 00"

REDMAN 1-HI.79

-118° 00' 00"

LANCASTER EAST 1-HI.68

HI VISTA 1-HI.70

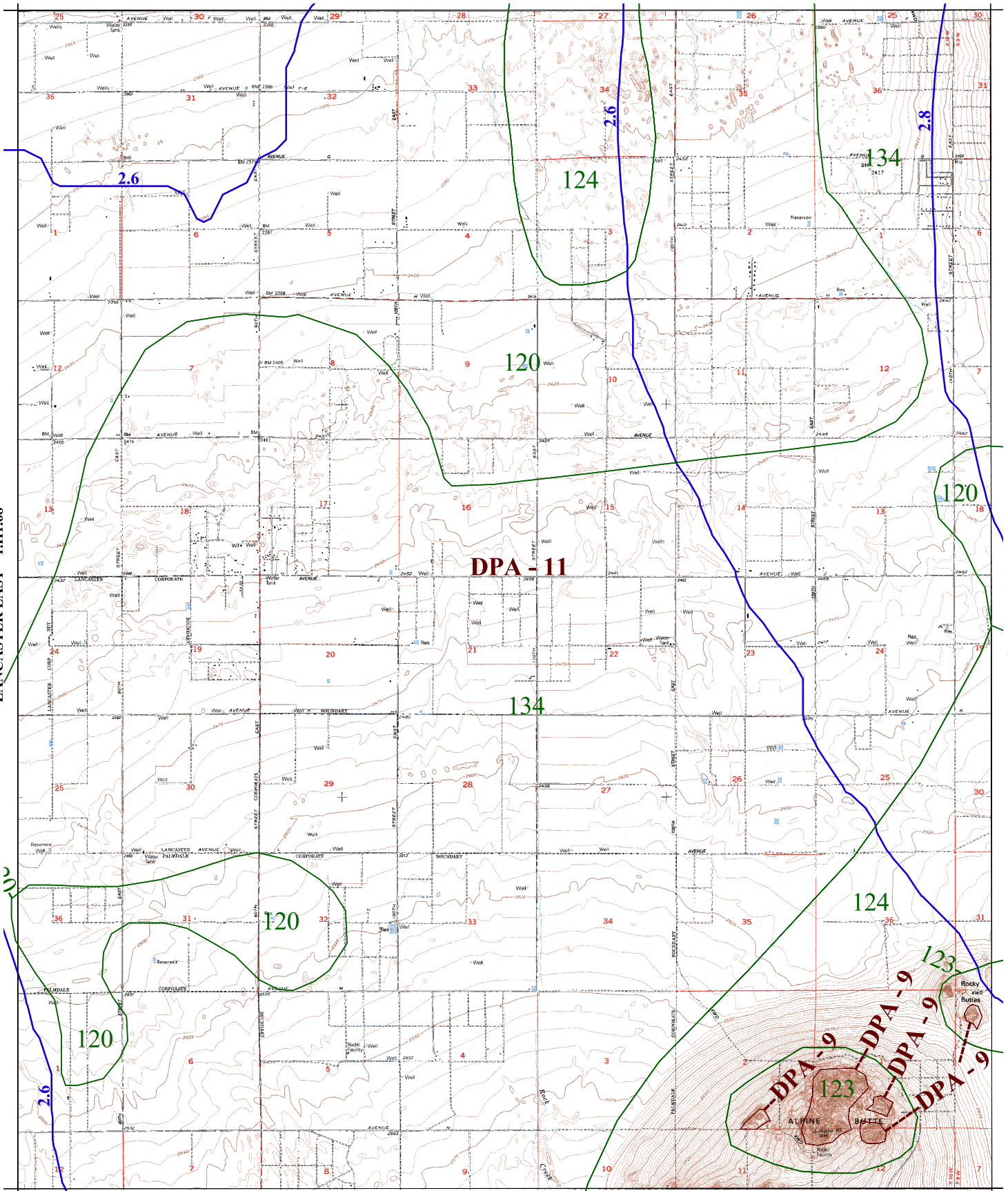

-117° 52' 30"

LITTLE ROCK 1-HI.59

34° 37' 30"



016 SOIL CLASSIFICATION AREA

7.2 INCHES OF RAINFALL

DPA - 6 DEBRIS POTENTIAL AREA

1 0 1 2 Miles

25-YEAR 24-HOUR ISOHYET REDUCTION FACTOR: 0.878
 10-YEAR 24-HOUR ISOHYET REDUCTION FACTOR: 0.714

ALPINE BUTTE
50-YEAR 24-HOUR ISOHYET

1-HI.69



34° 45' 00"

ROGERS LAKE SOUTH 1-H1.80

-117° 52' 30"

ALPINE BUTTE 1-H1.69

ADOBE MOUNTAIN 1-H1.71

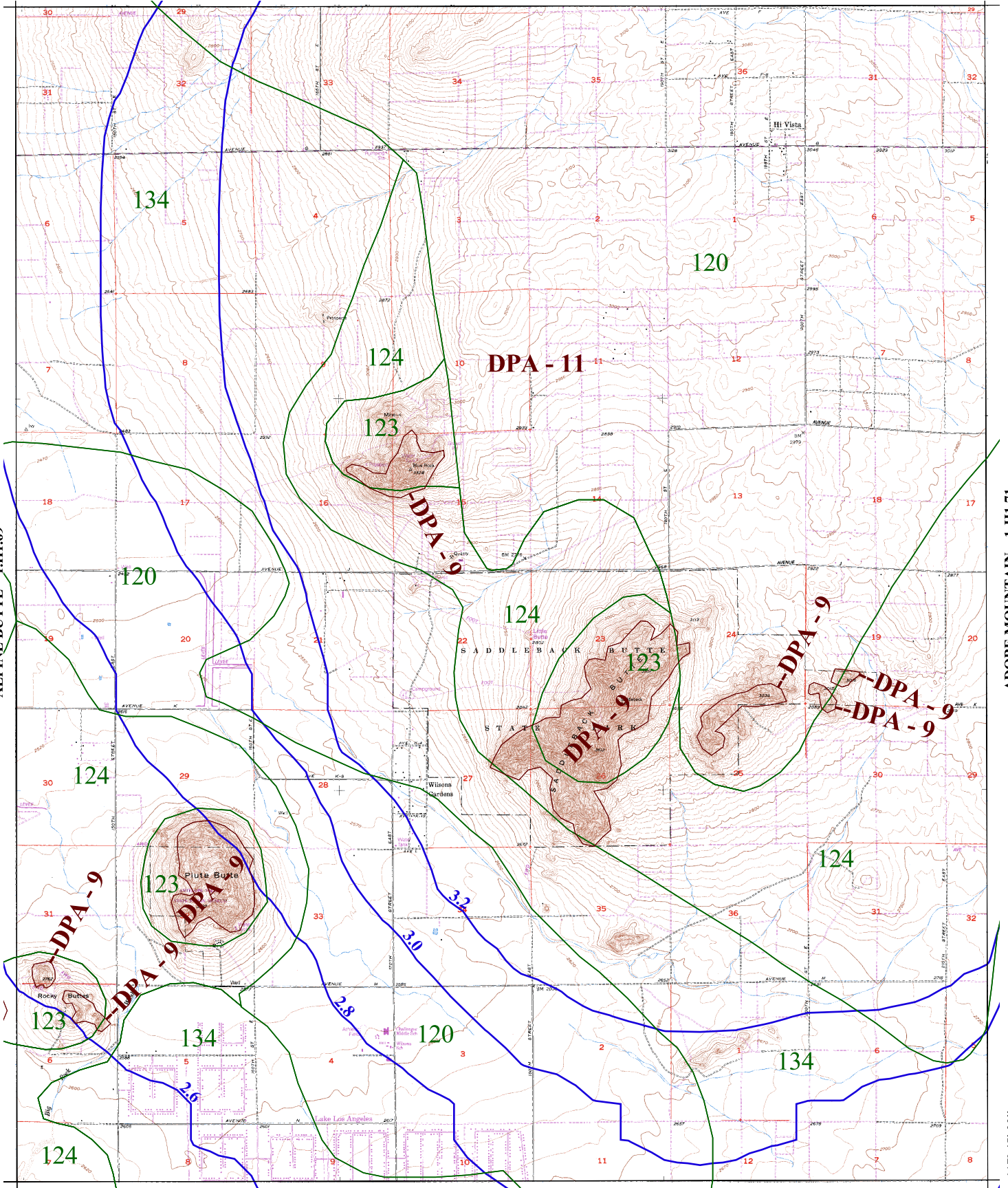

-117° 45' 00"

LOVEJOY BUTTES 1-H1.60

34° 37' 30"



016

SOIL CLASSIFICATION AREA

7.2

INCHES OF RAINFALL

DPA - 6

DEBRIS POTENTIAL AREA

1 0 1 2 Miles

25-YEAR 24-HOUR ISOHYET REDUCTION FACTOR: 0.878
10-YEAR 24-HOUR ISOHYET REDUCTION FACTOR: 0.714

HI VISTA 50-YEAR 24-HOUR ISOHYET

1-H1.70



34° 45' 00"

JACK RABBIT HILL 1-H1.81

-117° 45' 00"

HI VISTA 1-H1.70

SHADOW MOUNTAINS

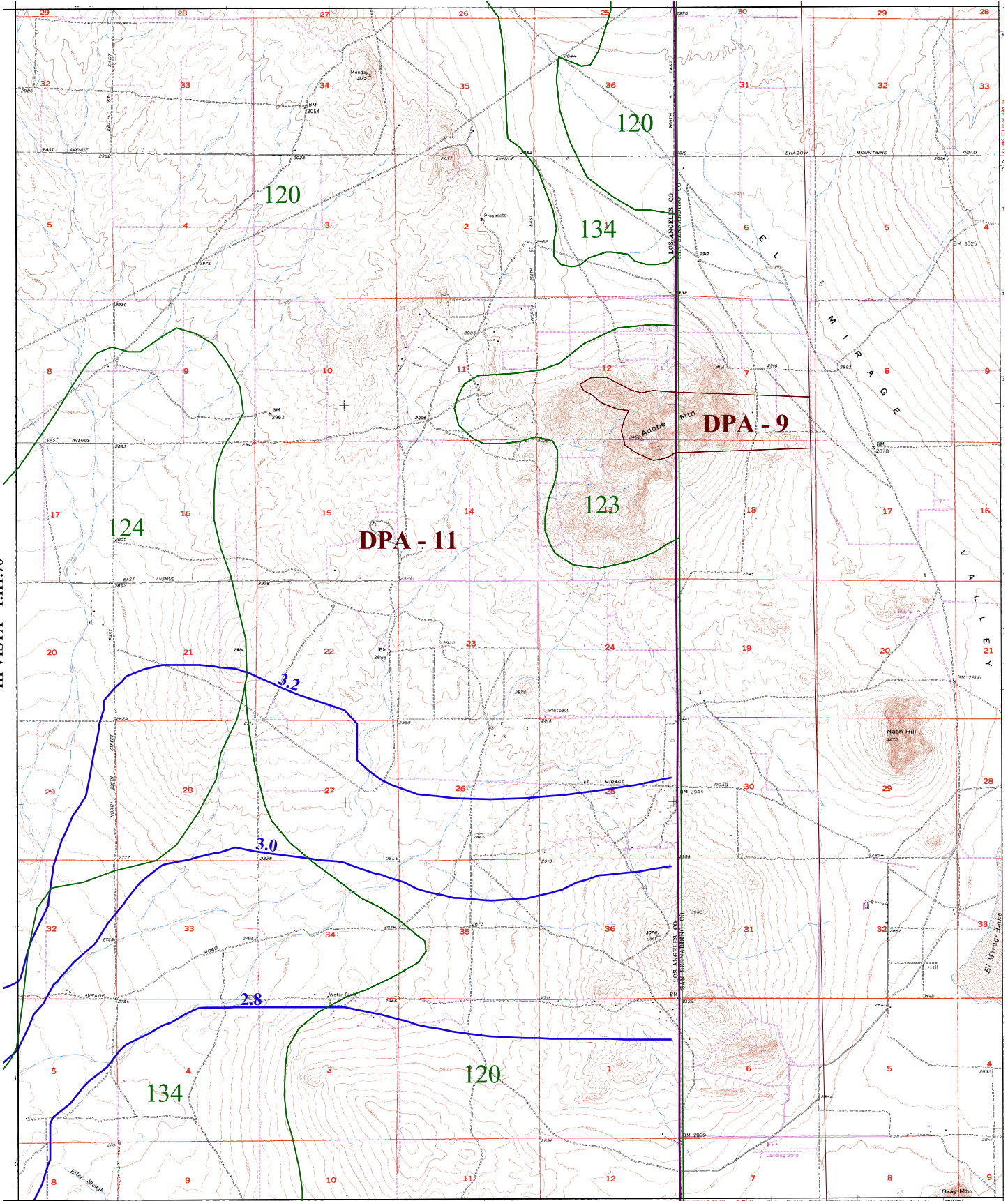

-117° 37' 30"

EL MIRAGE 1-H1.61

34° 37' 30"



016

SOIL CLASSIFICATION AREA

7.2

INCHES OF RAINFALL

DPA - 6

DEBRIS POTENTIAL AREA

1 0 1 2 Miles

25-YEAR 24-HOUR ISOHYET REDUCTION FACTOR: 0.878
10-YEAR 24-HOUR ISOHYET REDUCTION FACTOR: 0.714

ADOBE MOUNTAIN 50-YEAR 24-HOUR ISOHYET

1-H1.71



34° 52' 30"

PASTORIA CREEK

-118° 52' 30"

I-HI.72A

FRAZIER MOUNTAIN

10-3-PADRES

10-3-VALLEY

10-3-VALLEY

10-3-VALLEY

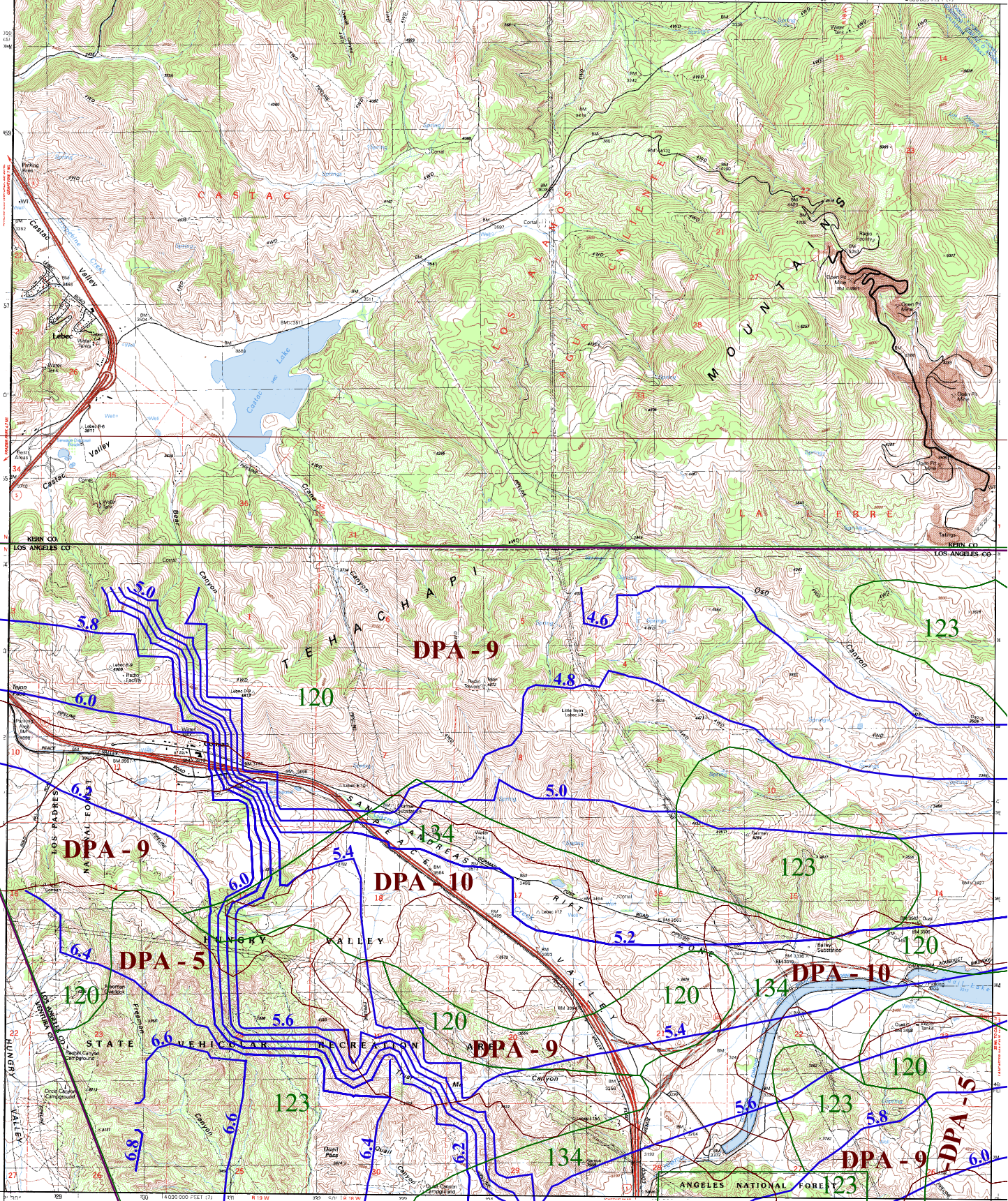

LA LIEBRE RANCH I-HI.73

-118° 45' 00"

BLACK MOUNTAIN I-HI.62

34° 45' 00"



016

SOIL CLASSIFICATION AREA

7.2

INCHES OF RAINFALL

DPA - 6

DEBRIS POTENTIAL AREA

1 0 1 2 Miles

25-YEAR 24-HOUR ISOHYET REDUCTION FACTOR: 0.878

10-YEAR 24-HOUR ISOHYET REDUCTION FACTOR: 0.714

L E B E C

50-YEAR 24-HOUR ISOHYET

I-HI.72



34° 52' 30"

WINTERS RIDGE 1-HI.73A

-118° 45' 00"

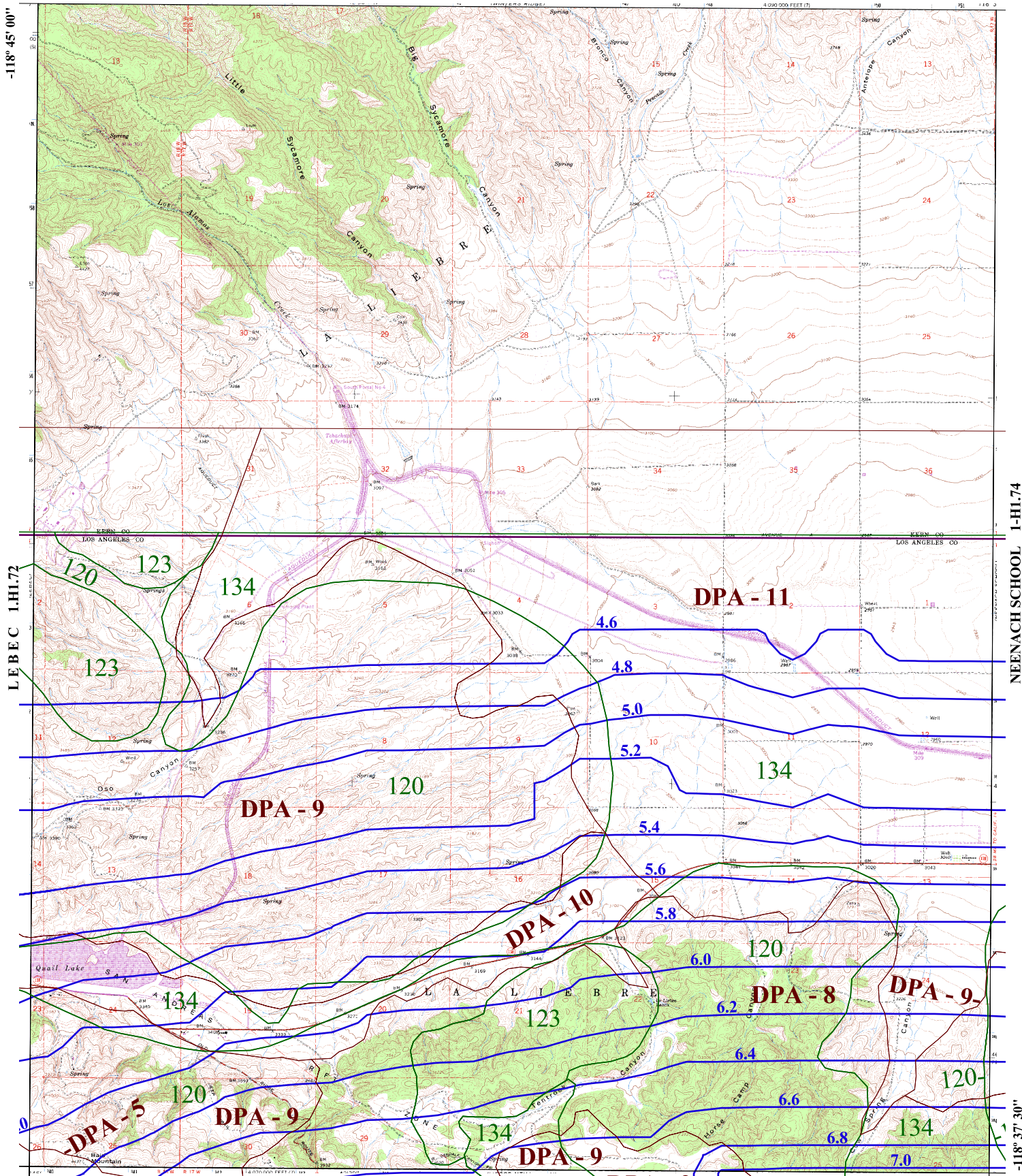

LEBEC 1-HI.72

NEENACH SCHOOL 1-HI.74

LIEBRE MOUNTAIN 1-HI.63

34° 45' 00"

-118° 37' 30"



016 SOIL CLASSIFICATION AREA

7.2 INCHES OF RAINFALL

DPA - 6 DEBRIS POTENTIAL AREA

1 0 1 2 Miles

25-YEAR 24-HOUR ISOHYET REDUCTION FACTOR: 0.878
 10-YEAR 24-HOUR ISOHYET REDUCTION FACTOR: 0.714

**LA LIEBRE RANCH
 50-YEAR 24-HOUR ISOHYET**

1-HI.73



34° 52' 30"

LIEBRE TWINS 1-HI.74A

-118° 37' 30"

LA LIEBRE RANCH 1-HI.73

FAIRMONT BUTTE 1-HI.75

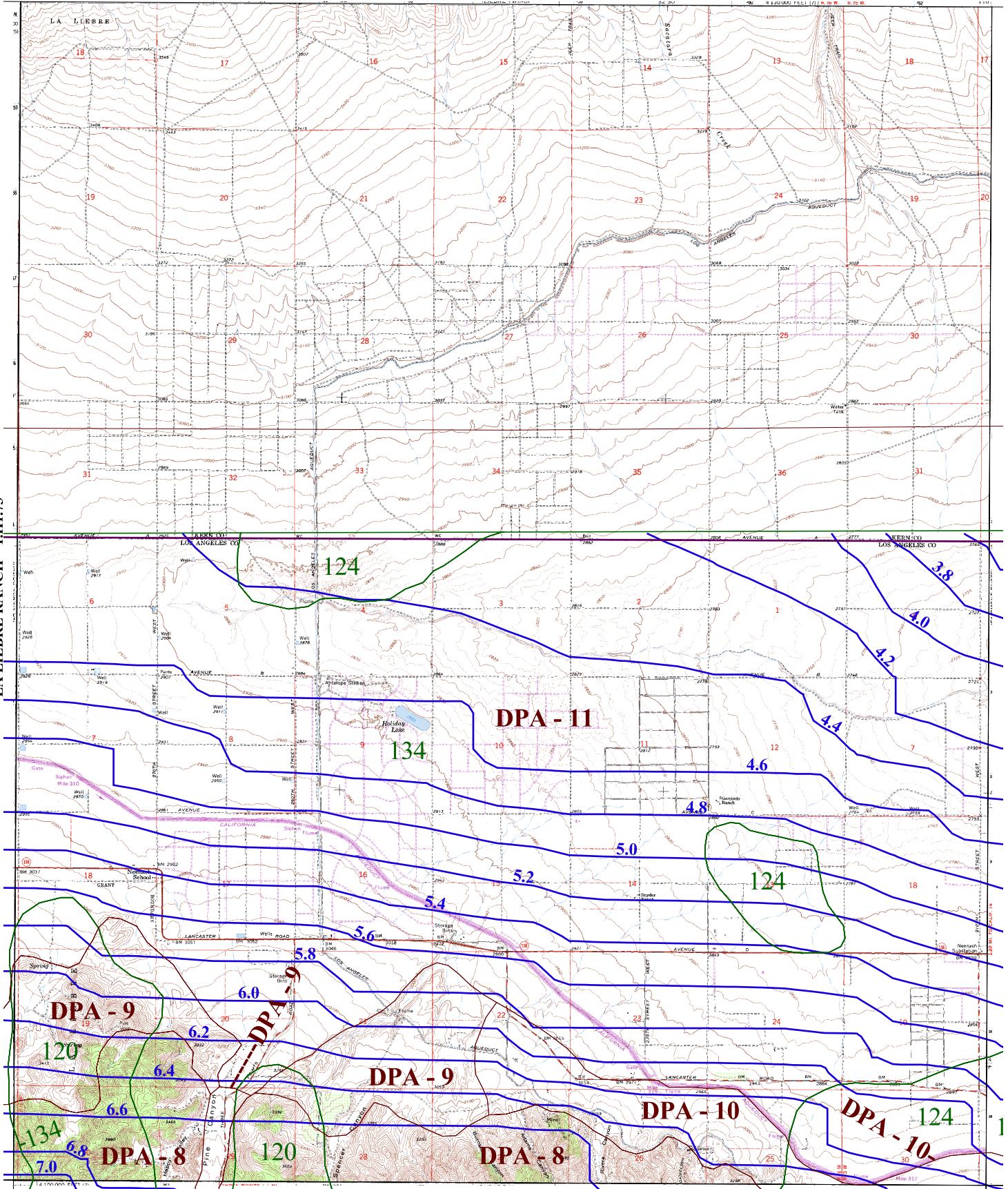

-118° 30' 00"

BURNT PEAK 1-HI.64

34° 45' 00"



016 SOIL CLASSIFICATION AREA

7.2 INCHES OF RAINFALL

DPA - 6 DEBRIS POTENTIAL AREA

1 0 1 2 Miles

25-YEAR 24-HOUR ISOHYET REDUCTION FACTOR: 0.878
 10-YEAR 24-HOUR ISOHYET REDUCTION FACTOR: 0.714

**NEENACH SCHOOL
 50-YEAR 24-HOUR ISOHYET**

1-HI.74



34° 52' 30"

TYLERHORSE CANYON 1-HI.75A

-118° 30' 00"

NEENACH SCHOOL 1-HI.74

LITTLE BUTTES 1-HI.76

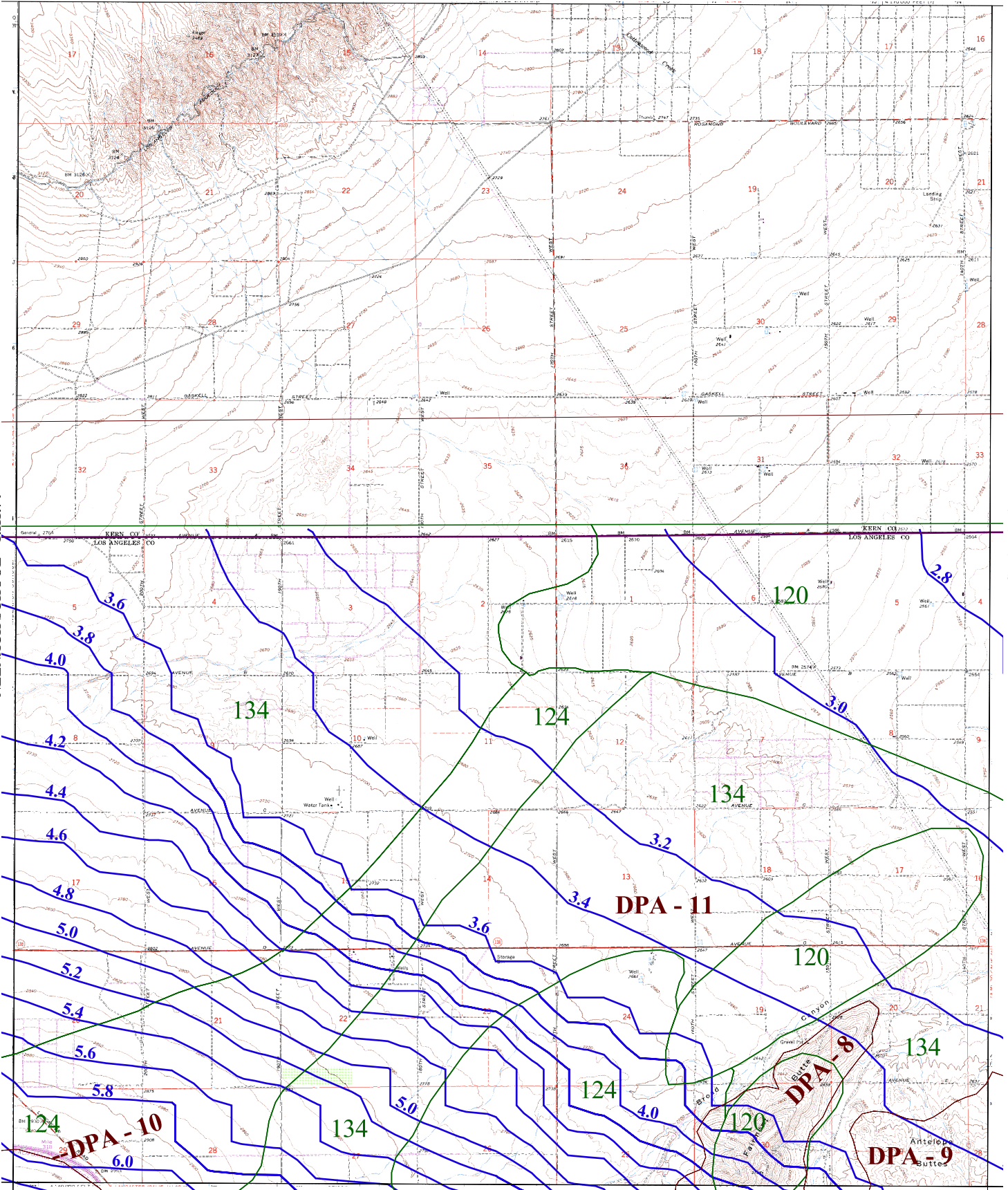

-118° 22' 30"

LAKE HUGHES 1-HI.65

34° 45' 00"



016

SOIL CLASSIFICATION AREA

7.2

INCHES OF RAINFALL

DPA - 6

DEBRIS POTENTIAL AREA

1 0 1 2 Miles

25-YEAR 24-HOUR ISOHYET REDUCTION FACTOR: 0.878
10-YEAR 24-HOUR ISOHYET REDUCTION FACTOR: 0.714

**FAIRMONT BUTTE
50-YEAR 24-HOUR ISOHYET**

1-HI.75



34° 52' 30"

WILLOW SPRINGS

-118° 22' 30"

FAIRMONT BUTTE 1-HI.75

ROSAMOND 1-HI.77

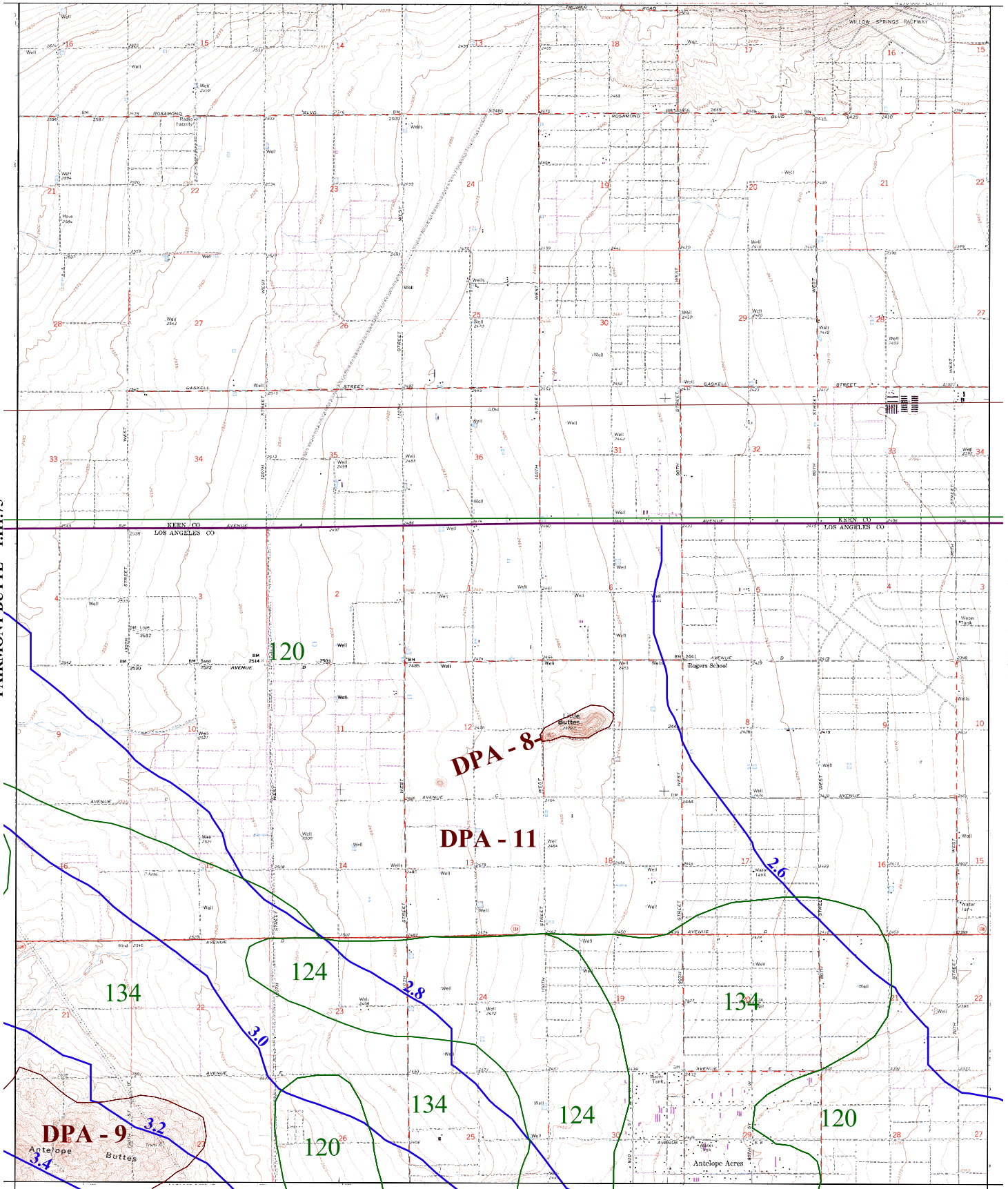

DEL SUR 1-HI.66

34° 45' 00"

-118° 15' 00"



016

SOIL CLASSIFICATION AREA

7.2

INCHES OF RAINFALL

DPA - 6

DEBRIS POTENTIAL AREA

1 0 1 2 Miles

25-YEAR 24-HOUR ISOHYET REDUCTION FACTOR: 0.878
10-YEAR 24-HOUR ISOHYET REDUCTION FACTOR: 0.714

LITTLE BUTTES 50-YEAR 24-HOUR ISOHYET

1-HI.76



34° 52' 30"

SOLEDAD MOUNTAIN

-118° 15' 00"

LITTLE BUTTES 1-HI.76

ROSAMOND LAKE 1-HI.78

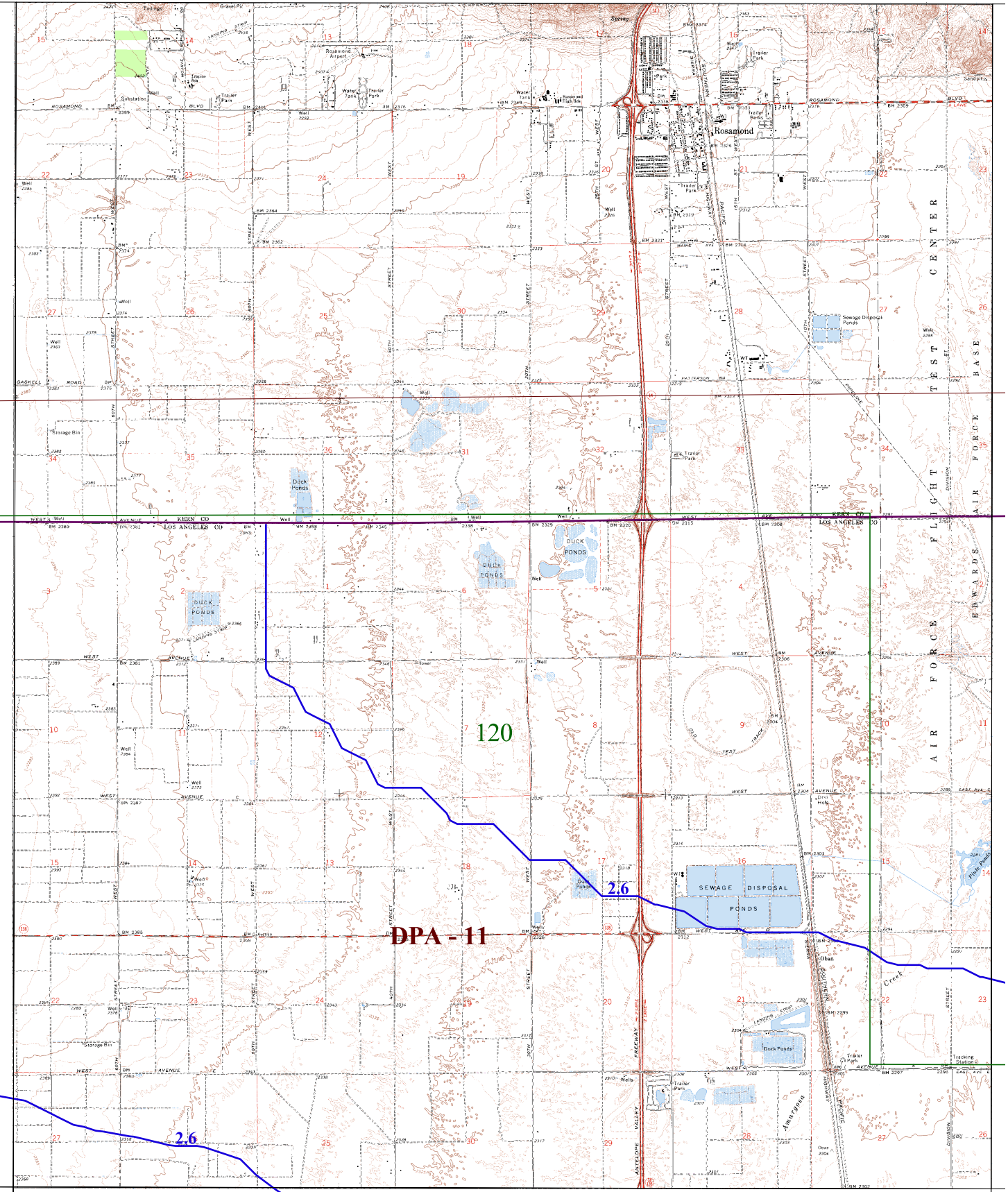

-118° 07' 30"

LANCASTER WEST 1-HI.67

34° 45' 00"



016 SOIL CLASSIFICATION AREA

7.2 INCHES OF RAINFALL

DPA - 6 DEBRIS POTENTIAL AREA

1 0 1 2 Miles

25-YEAR 24-HOUR ISOHYET REDUCTION FACTOR: 0.878
10-YEAR 24-HOUR ISOHYET REDUCTION FACTOR: 0.714

ROSAMOND 50-YEAR 24-HOUR ISOHYET

1-HI.77



34° 52' 30"

BISSEL

-118° 07' 30"

ROSAMOND 1-HI.77

REDMAN 1-HI.79

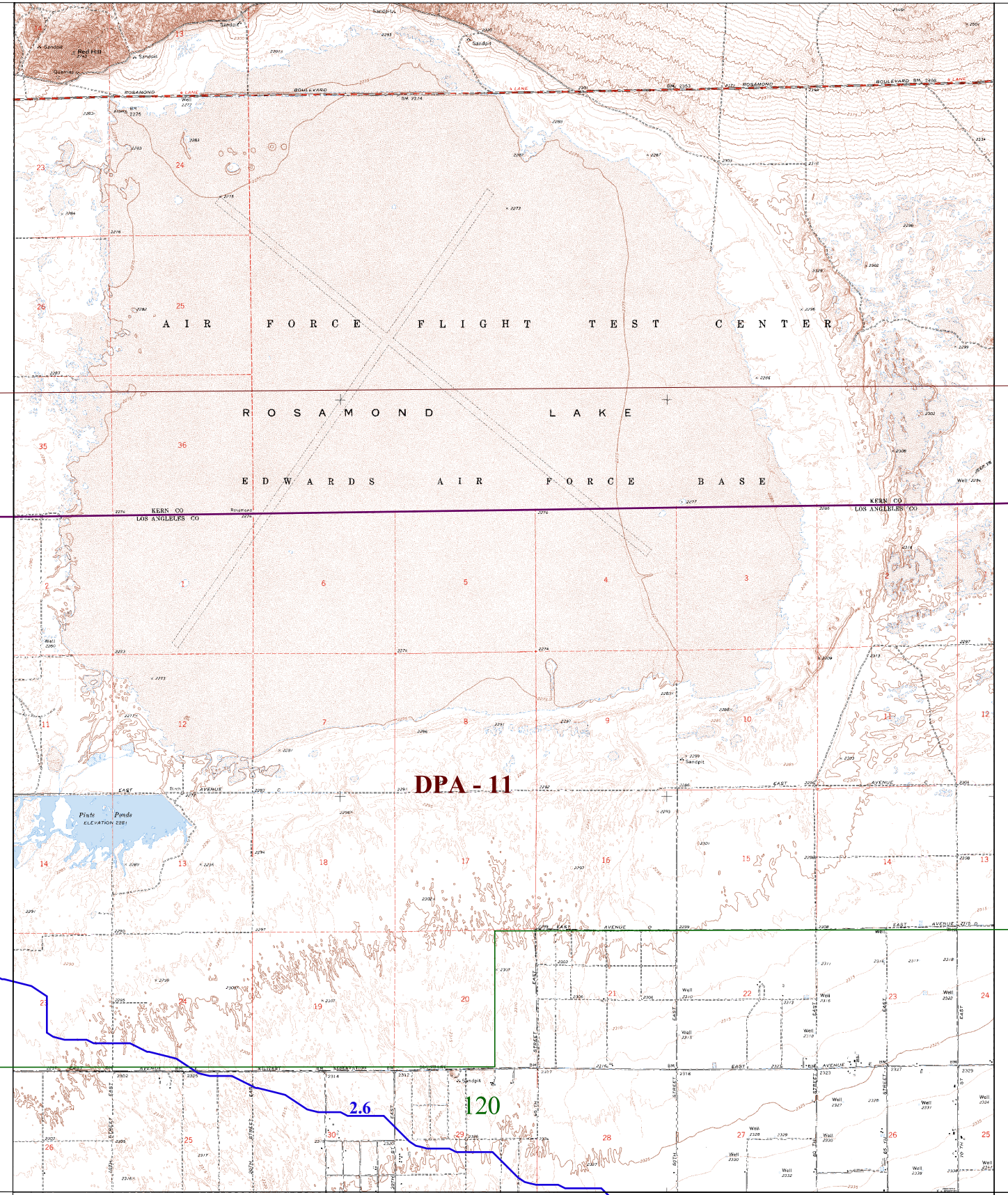

-118° 00' 00"

LANCASTER EAST 1-HI.68

34° 45' 00"



016 SOIL CLASSIFICATION AREA

7.2 INCHES OF RAINFALL

DPA - 6 DEBRIS POTENTIAL AREA

1 0 1 2 Miles

25-YEAR 24-HOUR ISOHYET REDUCTION FACTOR: 0.878
 10-YEAR 24-HOUR ISOHYET REDUCTION FACTOR: 0.714

ROSAMOND LAKE
50-YEAR 24-HOUR ISOHYET

1-HI.78



34° 52' 30"

FLUHR

-118° 00' 00"

ROSAMOND LAKE 1-HI.78

ROGERS LAKE SOUTH 1-HI.80

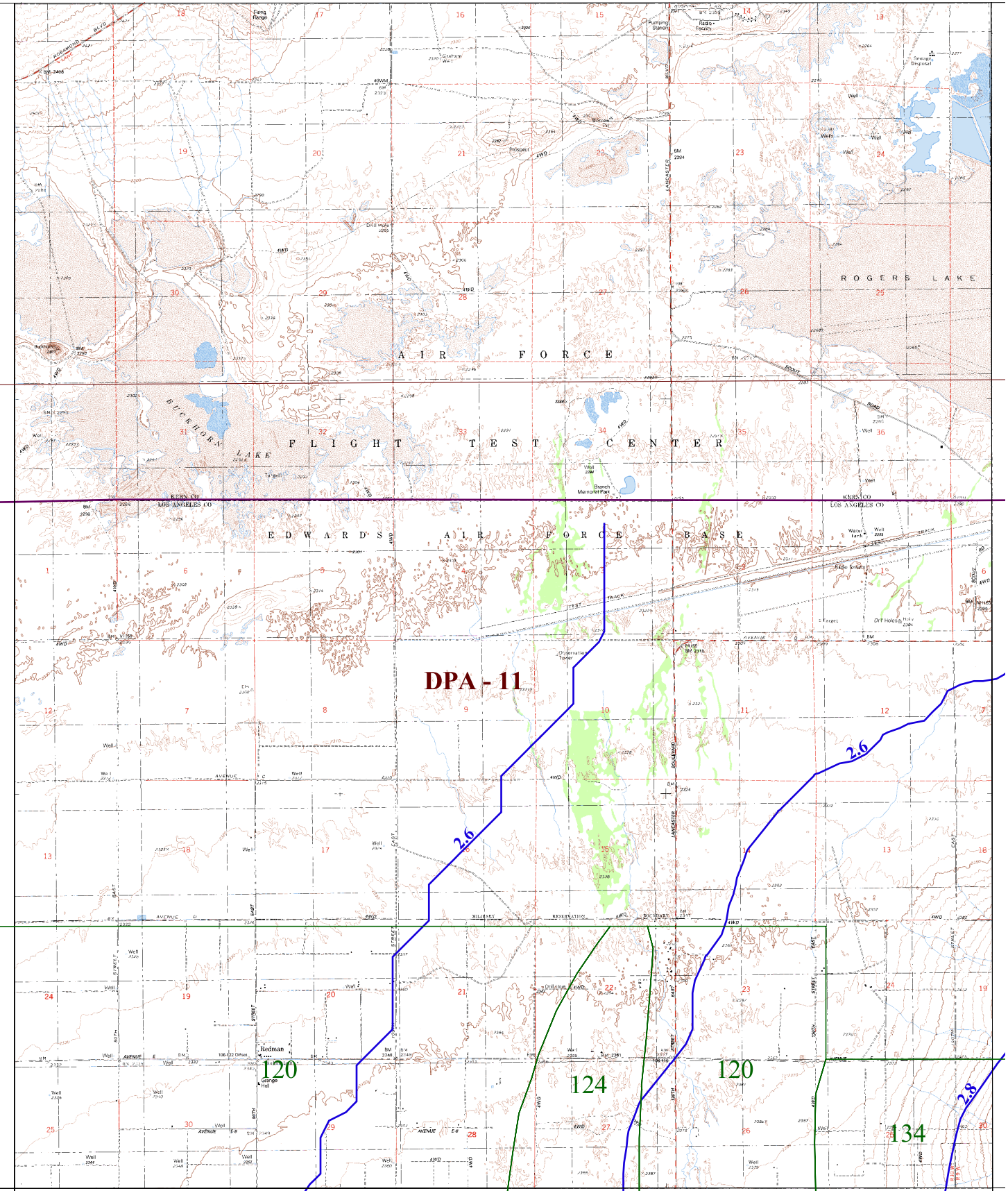

-117° 52' 30"

ALPINE BUTTE 1-HI.69

34° 45' 00"



016 SOIL CLASSIFICATION AREA

7.2 INCHES OF RAINFALL

DPA - 6 DEBRIS POTENTIAL AREA

1 0 1 2 Miles

25-YEAR 24-HOUR ISOHYET REDUCTION FACTOR: 0.878
 10-YEAR 24-HOUR ISOHYET REDUCTION FACTOR: 0.714

REDMAN 50-YEAR 24-HOUR ISOHYET

1-HI.79



34° 52' 30"

MUROC

-117° 52' 30"

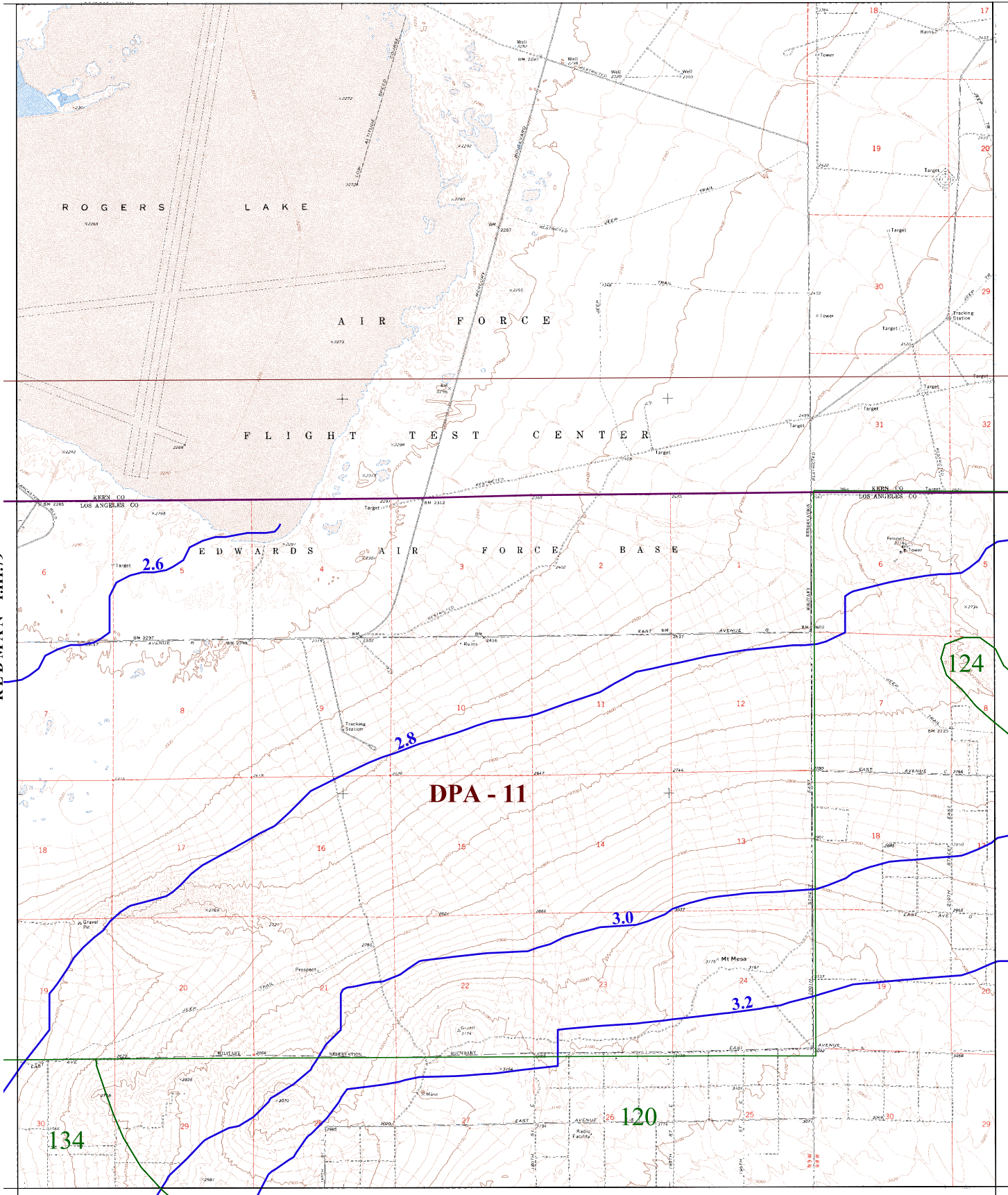

REDMAN 1-H1.79

JACK RABBIT HILL 1-H1.81

DPA - 11

HI VISTA 1-H1.70

34° 45' 00"

-117° 45' 00"



016

SOIL CLASSIFICATION AREA

7.2

INCHES OF RAINFALL

DPA - 6

DEBRIS POTENTIAL AREA

1 0 1 2 Miles

25-YEAR 24-HOUR ISOHYET REDUCTION FACTOR: 0.878
10-YEAR 24-HOUR ISOHYET REDUCTION FACTOR: 0.714

ROGERS LAKE SOUTH 50-YEAR 24-HOUR ISOHYET

1-H1.80



34° 52' 30"

RICH

-117° 45' 00"

ROGERS LAKE SOUTH 1-H1.80

RED BUTTES

-117° 37' 30"

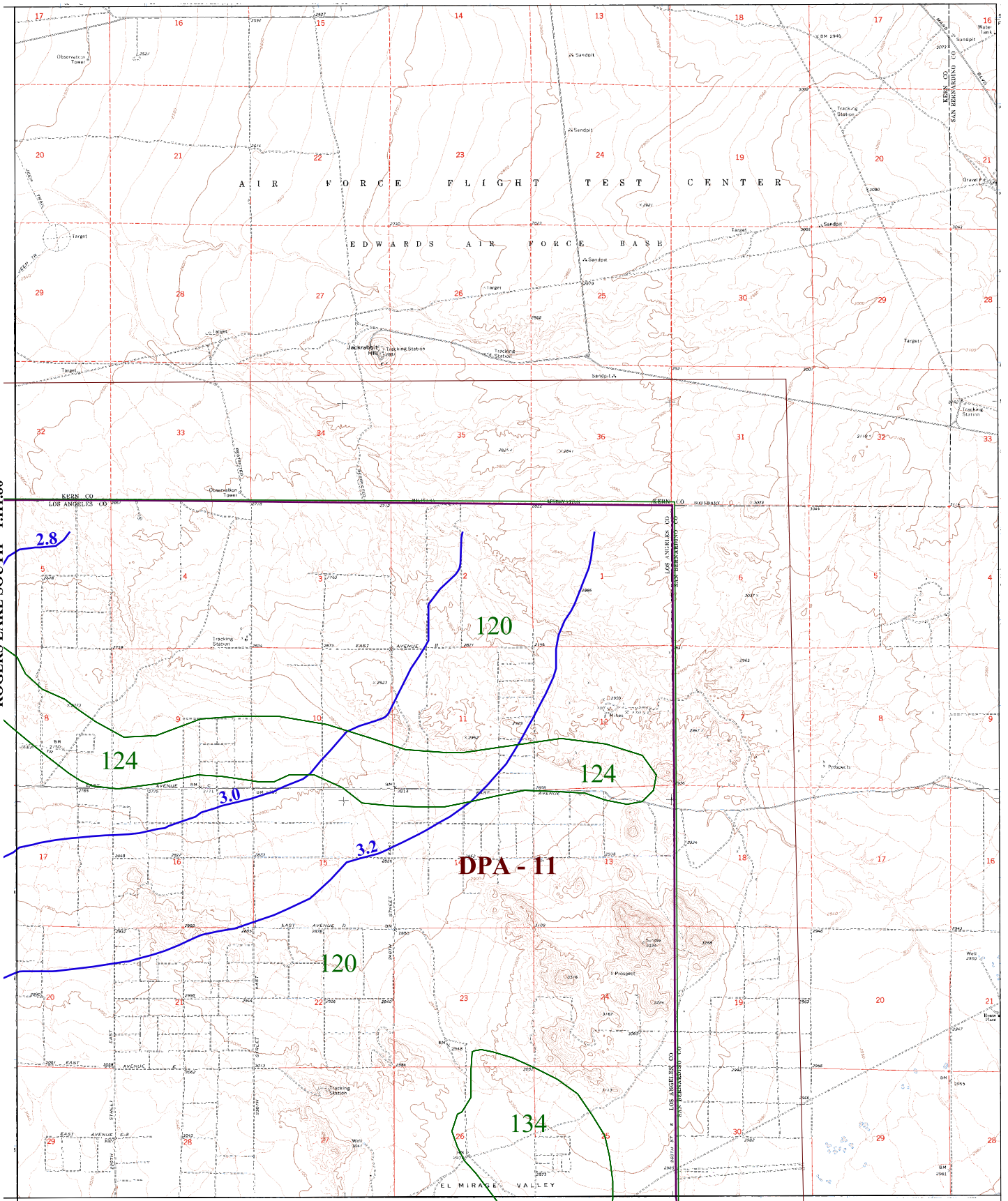

ADOBE MOUNTAIN 1-H1.71

34° 45' 00"



016

SOIL CLASSIFICATION AREA

7.2

INCHES OF RAINFALL

DPA - 6

DEBRIS POTENTIAL AREA

1 0 1 2 Miles

25-YEAR 24-HOUR ISOHYET REDUCTION FACTOR: 0.878
10-YEAR 24-HOUR ISOHYET REDUCTION FACTOR: 0.714

JACK RABBIT HILL
50-YEAR 24-HOUR ISOHYET

1-H1.81



APPENDIX B

Debris Production Rate Curves

Los Angeles Basin	B-1
Santa Clara Basin	B-2
Antelope Valley	B-3

Peak Bulking Factor Curves

Los Angeles Basin	B-4
Santa Clara Basin	B-5
Antelope Valley	B-6

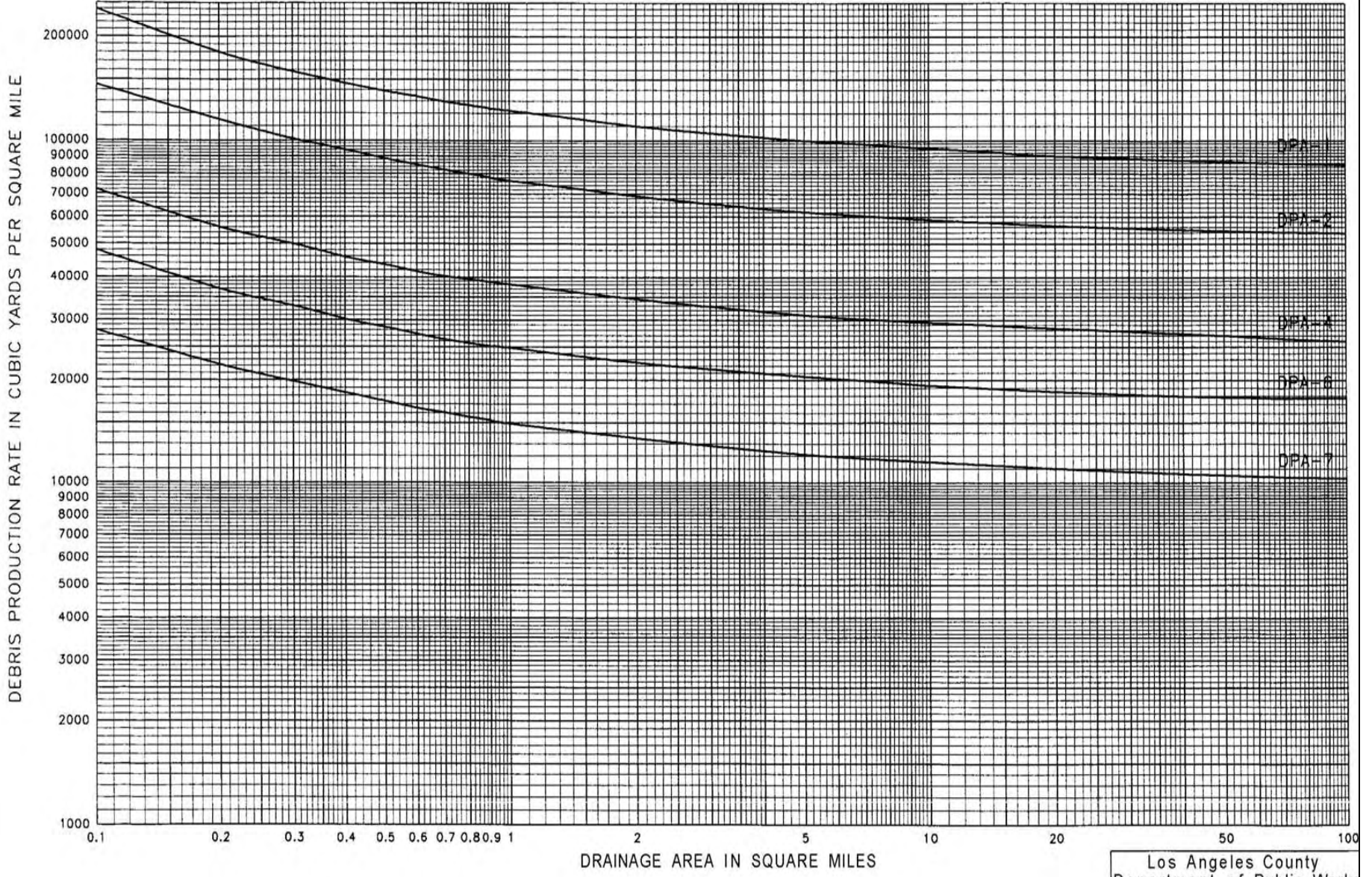

Los Angeles County
Department of Public Works
DEBRIS PRODUCTION RATES
for Los Angeles Basin

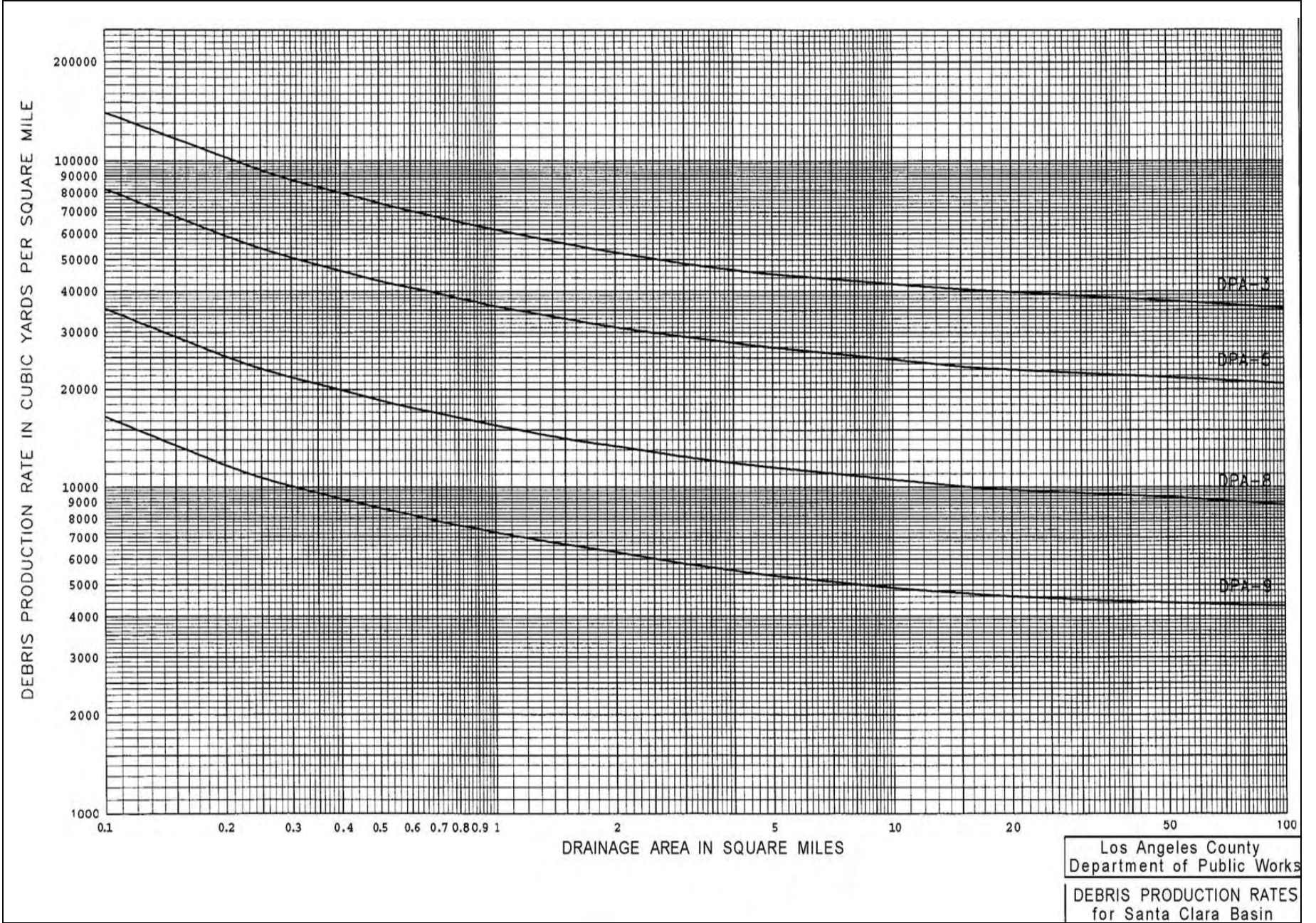

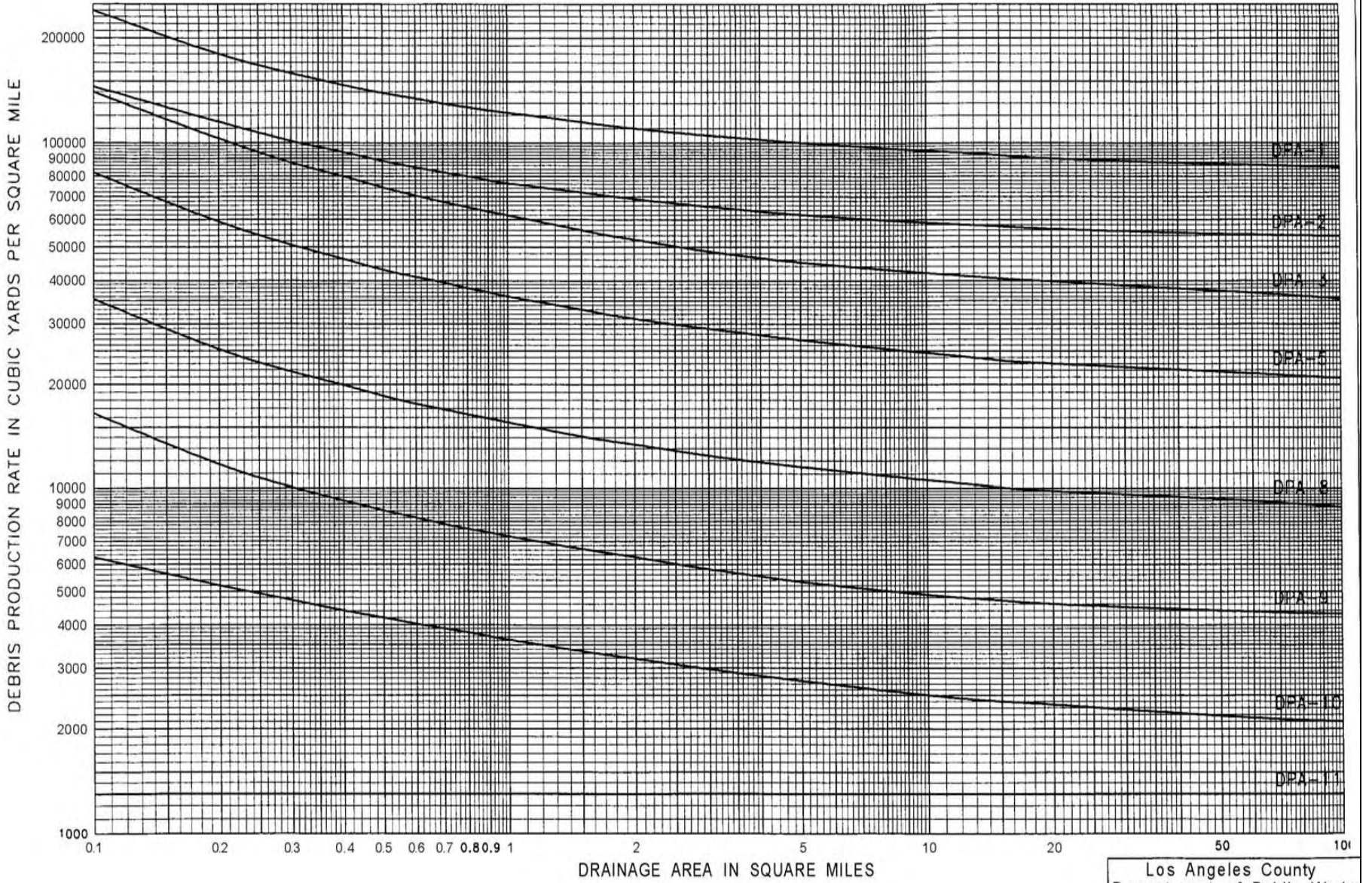

Los Angeles County
Department of Public Works
DEBRIS PRODUCTION RATES
for Antelope Valley

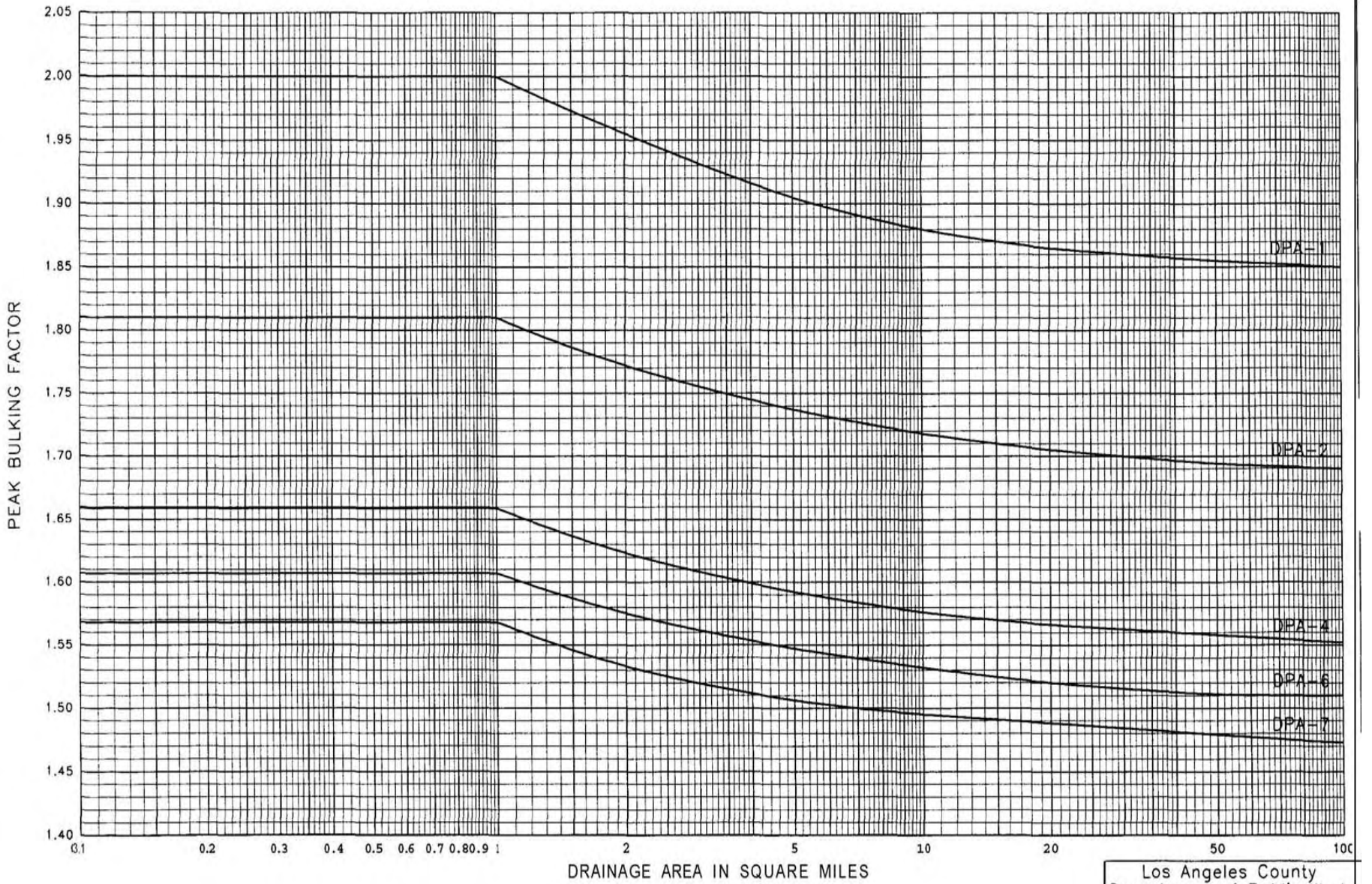

Los Angeles County
Department of Public Works
PEAK BULKING FACTORS
for Los Angeles Basin

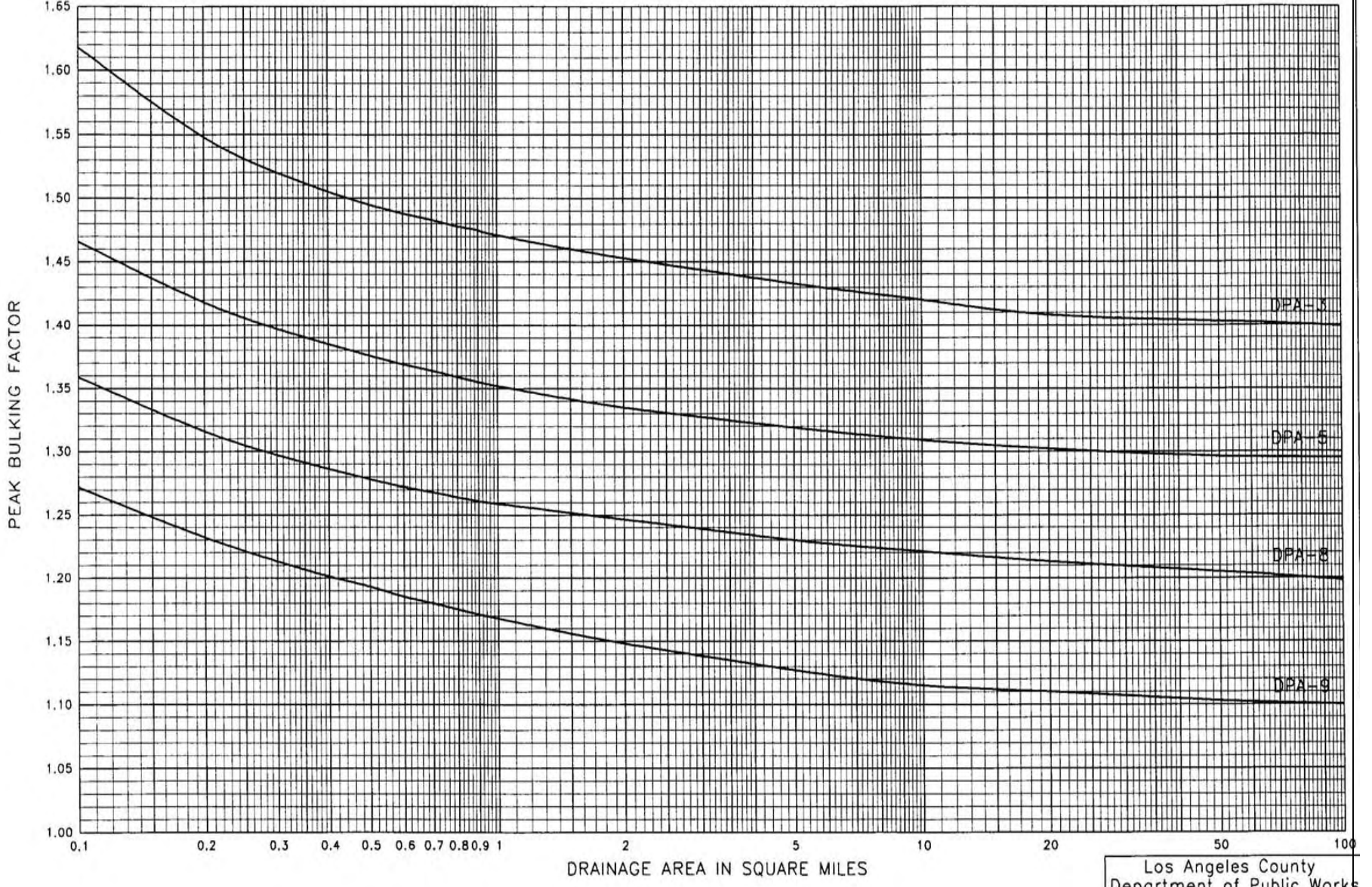

Los Angeles County
Department of Public Works
PEAK BULKING FACTORS
for Santa Clara Basin

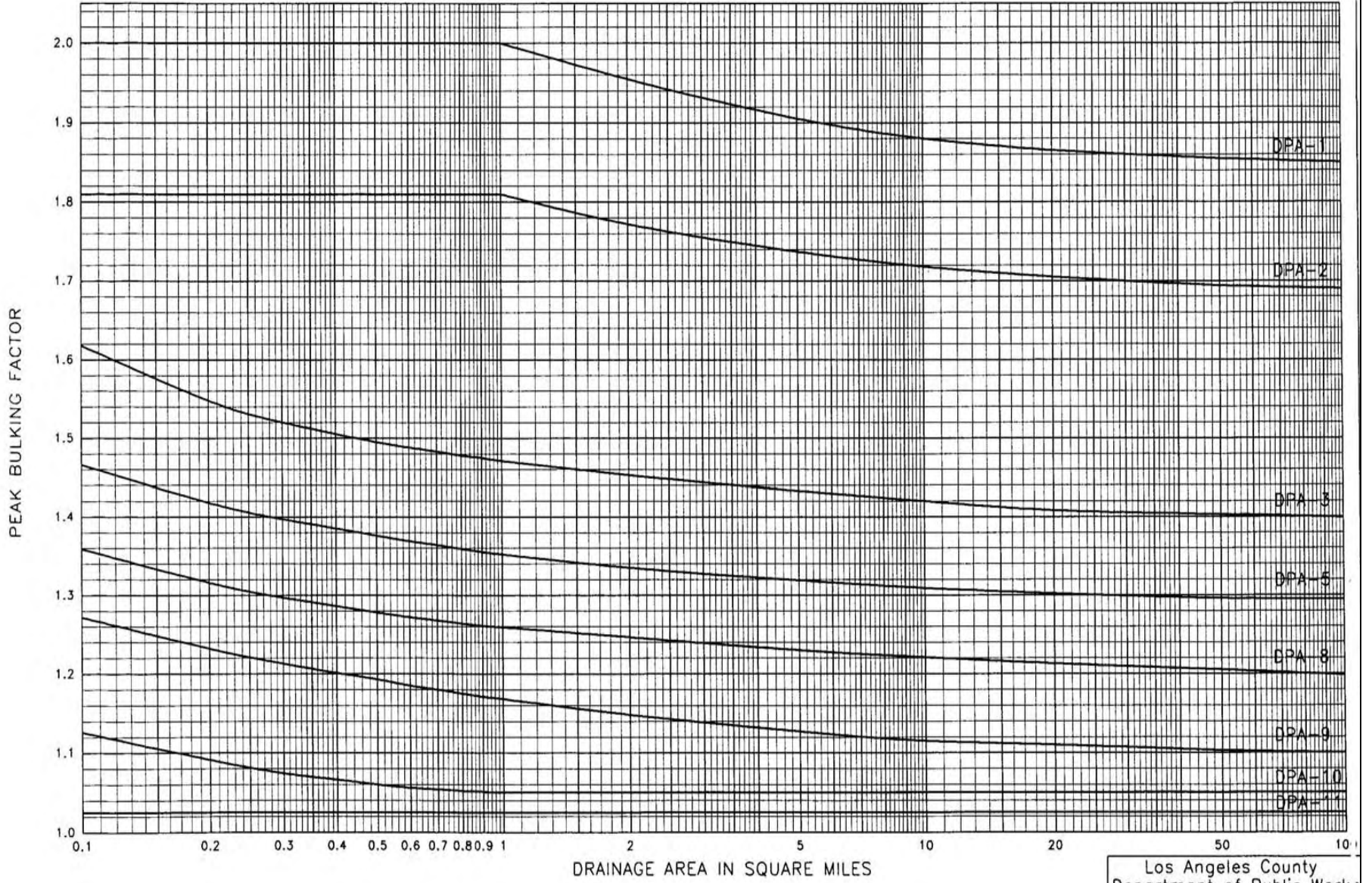

Los Angeles County
Department of Public Works
PEAK BULKING FACTORS
for Antelope Valley

APPENDIX C

Sedimentation Design Curves

Equilibrium Slope	C-1A-C
Stabilization Requirements	C-2
General Degradation	C-3
Pier Local Scour	C-4
Angle of Attack Multiplying Factors	C-5
Abutment Local Scour	C-6
Bend Scour	C-7A-C
Longitudinal Extent of Bend Scour	C-8
Bedform Height	C-9
Riprap Rock Size	C-10
Limiting Deposit Velocity	C-11A-B
Sedimentation Design Curves Source Equations	C-12-14

EQUILIBRIUM SLOPE

Natural Slope = 0.005

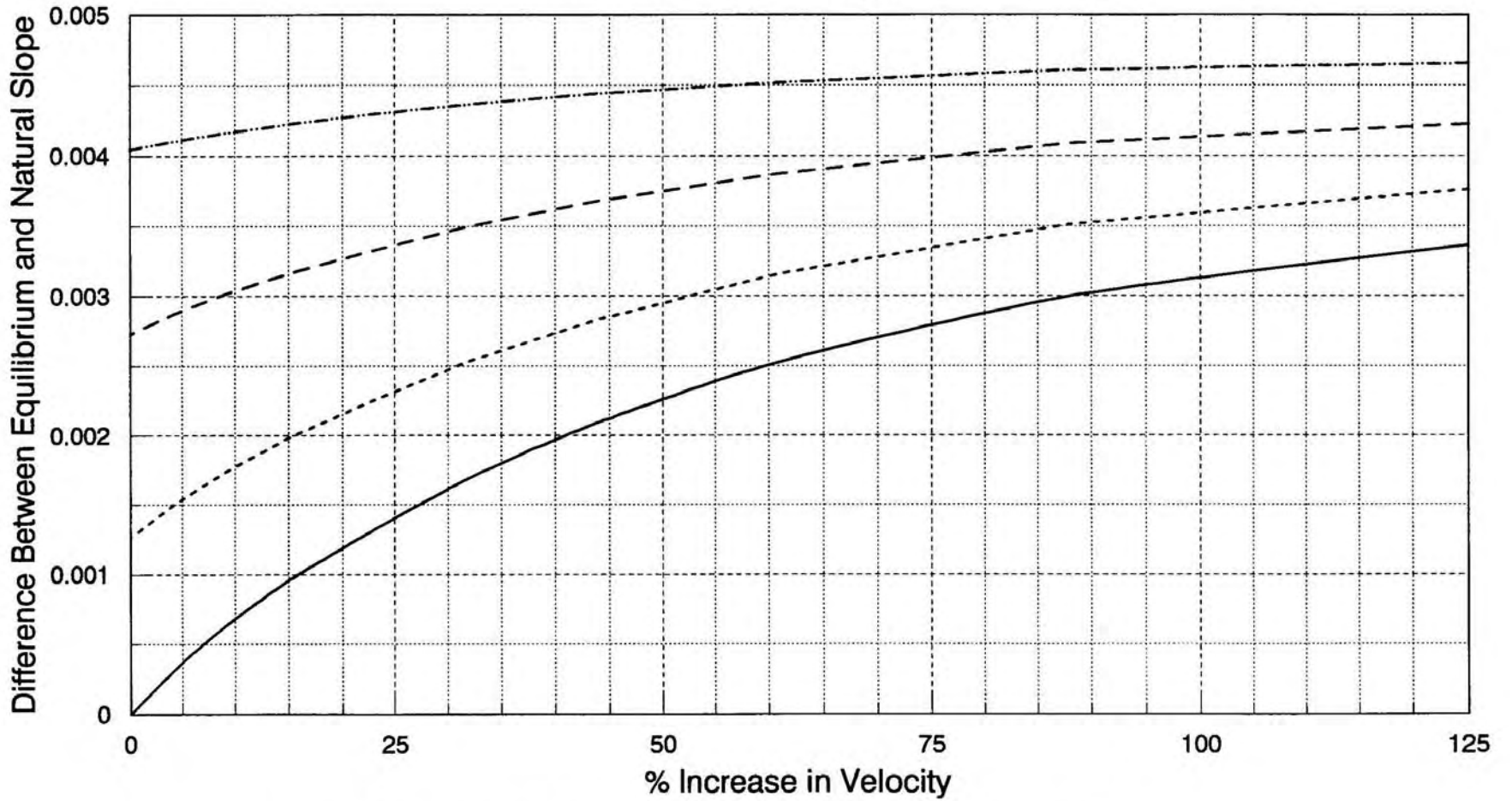

No Reduction in Sediment Supply	1/3 Reduction in Sediment Supply
-----	-----
2/3 Reduction in Sediment Supply	90% Reduction in Sediment Supply
-----	-----

EQUILIBRIUM SLOPE

Natural Slope = 0.01

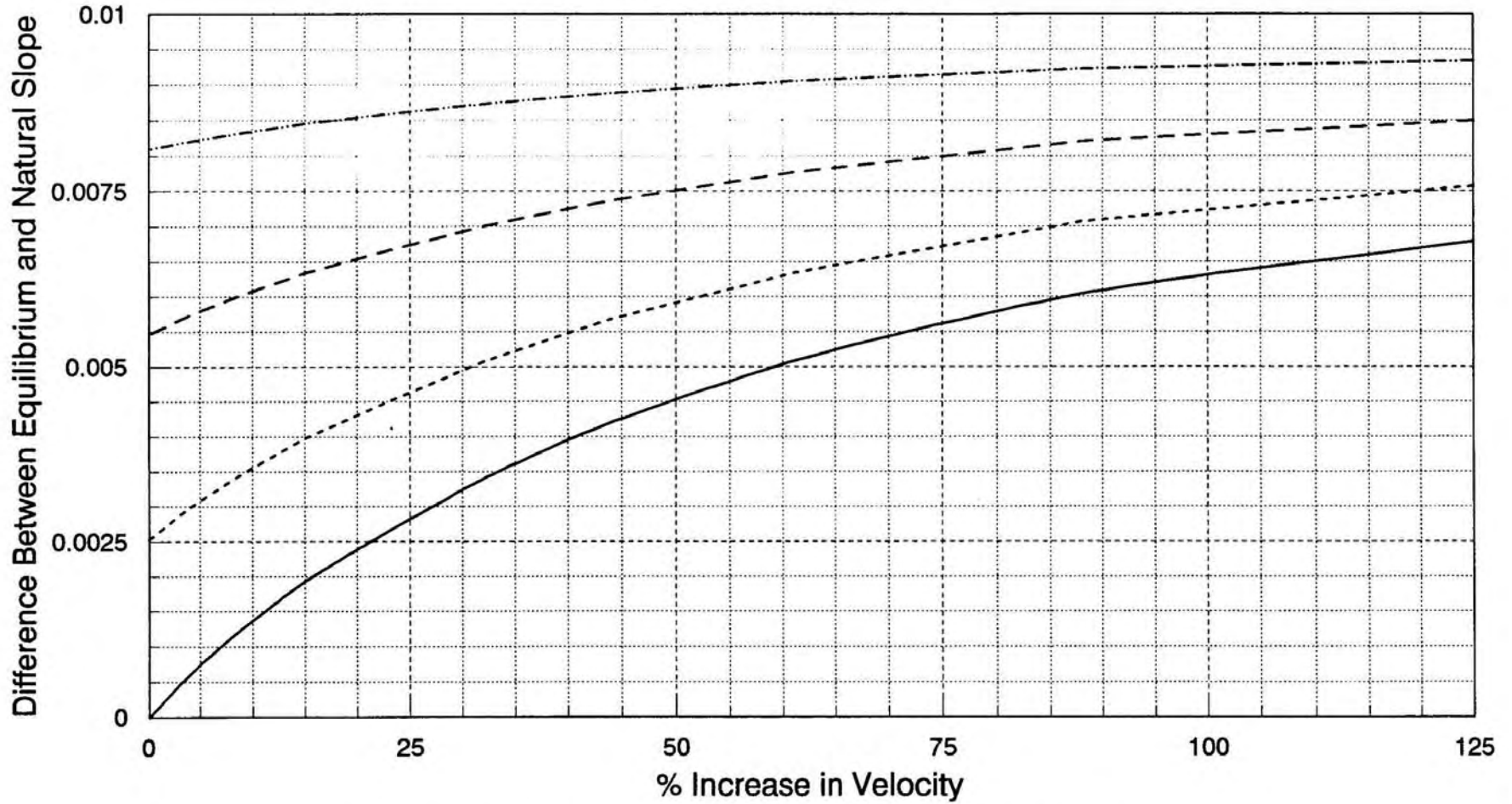

No Reduction in Sediment Supply	1/3 Reduction in Sediment Supply
—————
2/3 Reduction in Sediment Supply	90% Reduction in Sediment Supply
-----	- . - . - .

EQUILIBRIUM SLOPE

Natural Slope = 0.05

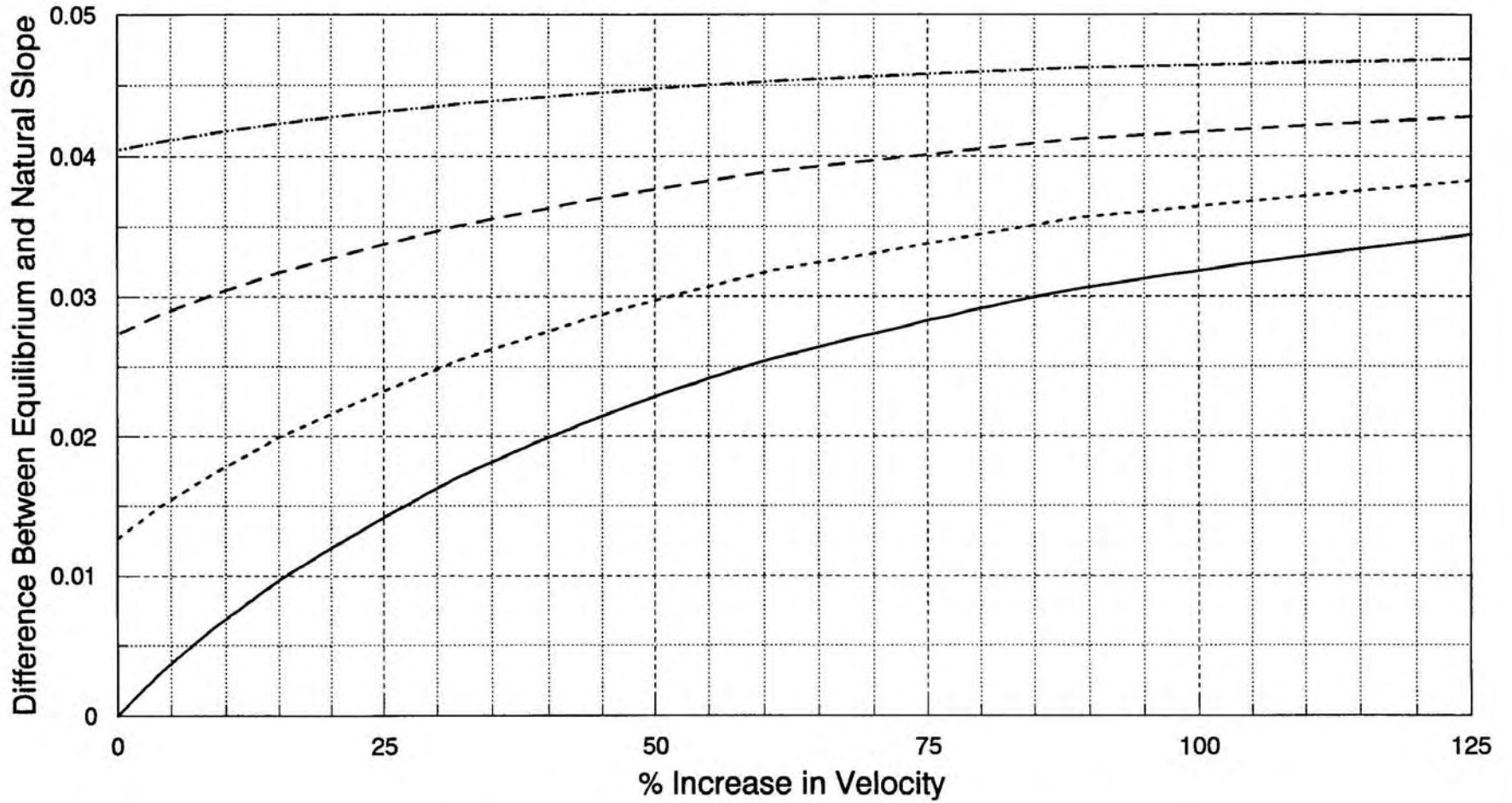

No Reduction in Sediment Supply 1/3 Reduction in Sediment Supply

2/3 Reduction in Sediment Supply 90% Reduction in Sediment Supply

STABILIZATION REQUIREMENTS

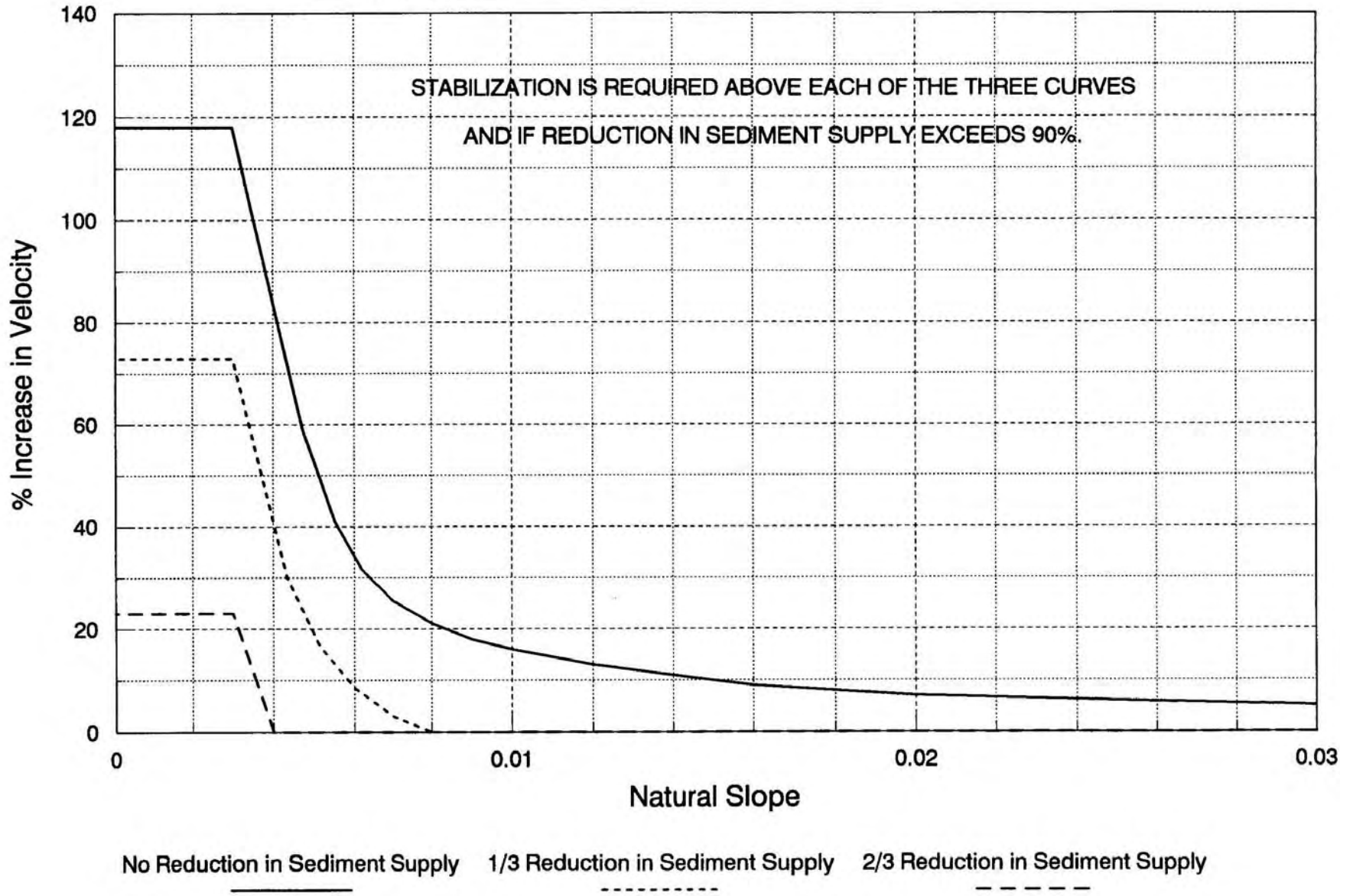

GENERAL DEGRADATION

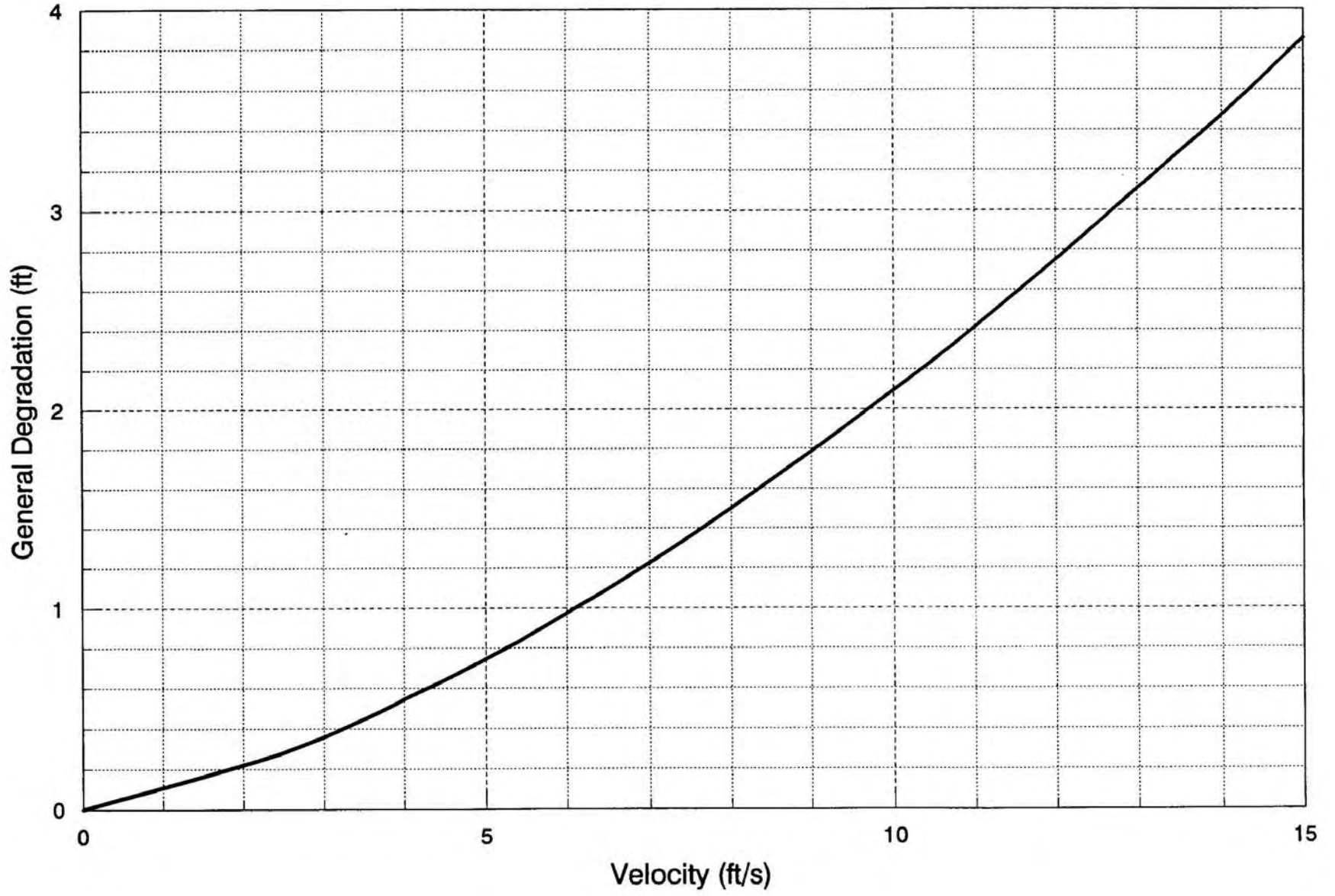

PIER LOCAL SCOUR

For Square Nose Piers

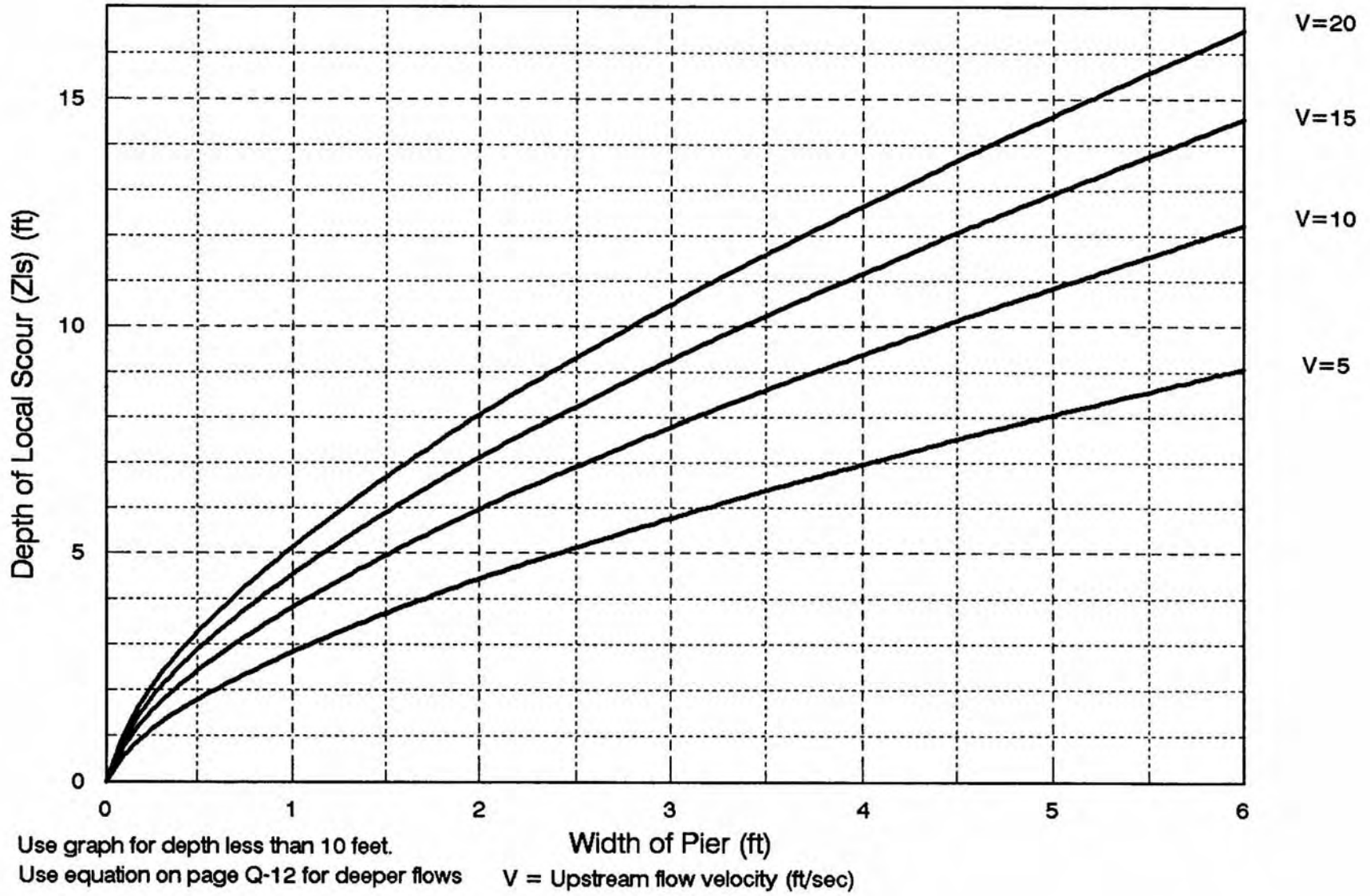

MULTIPLYING FACTORS FOR ANGLE OF ATTACK

To Be Used In Pier Local Scour Computations

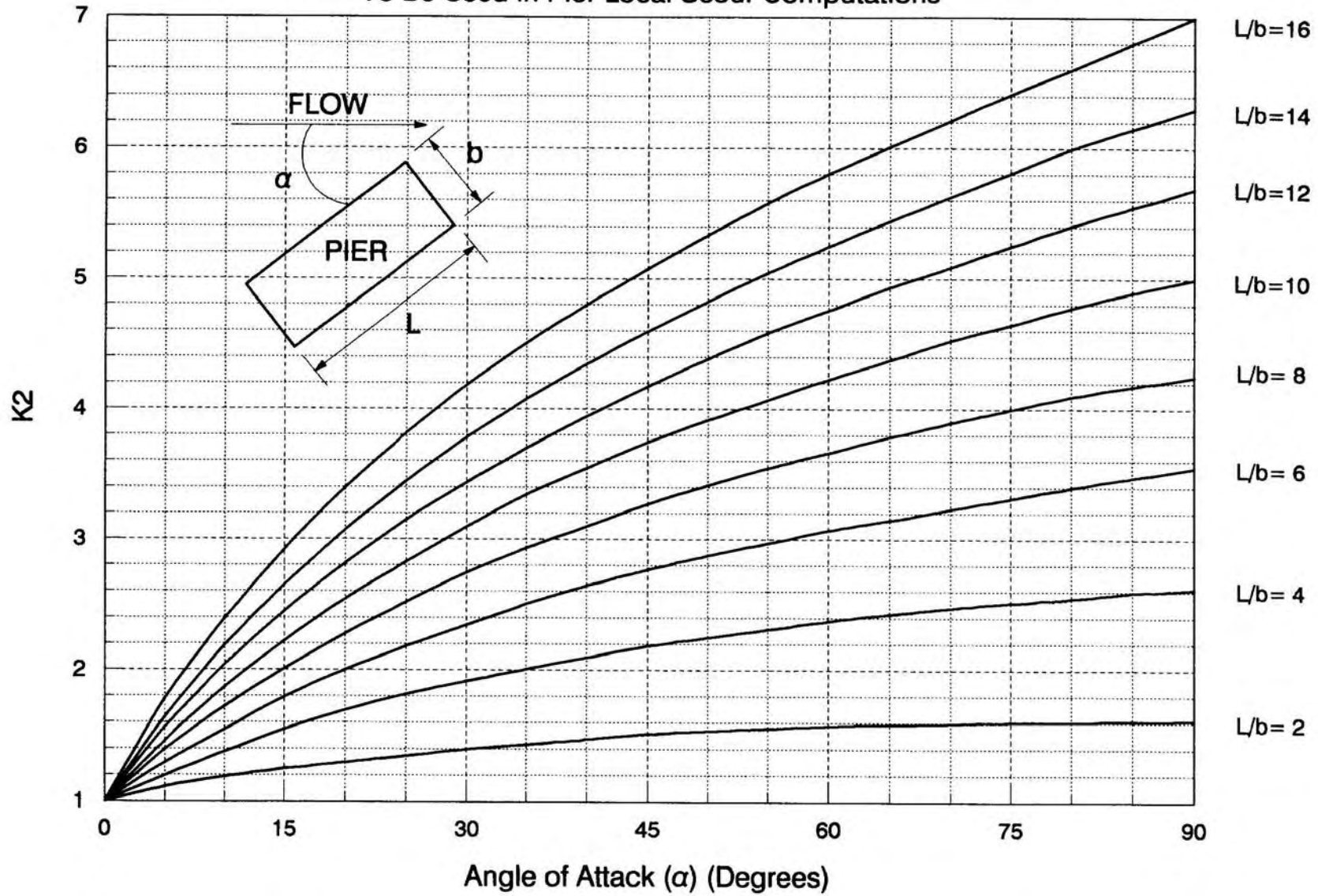

ABUTMENT LOCAL SCOUR

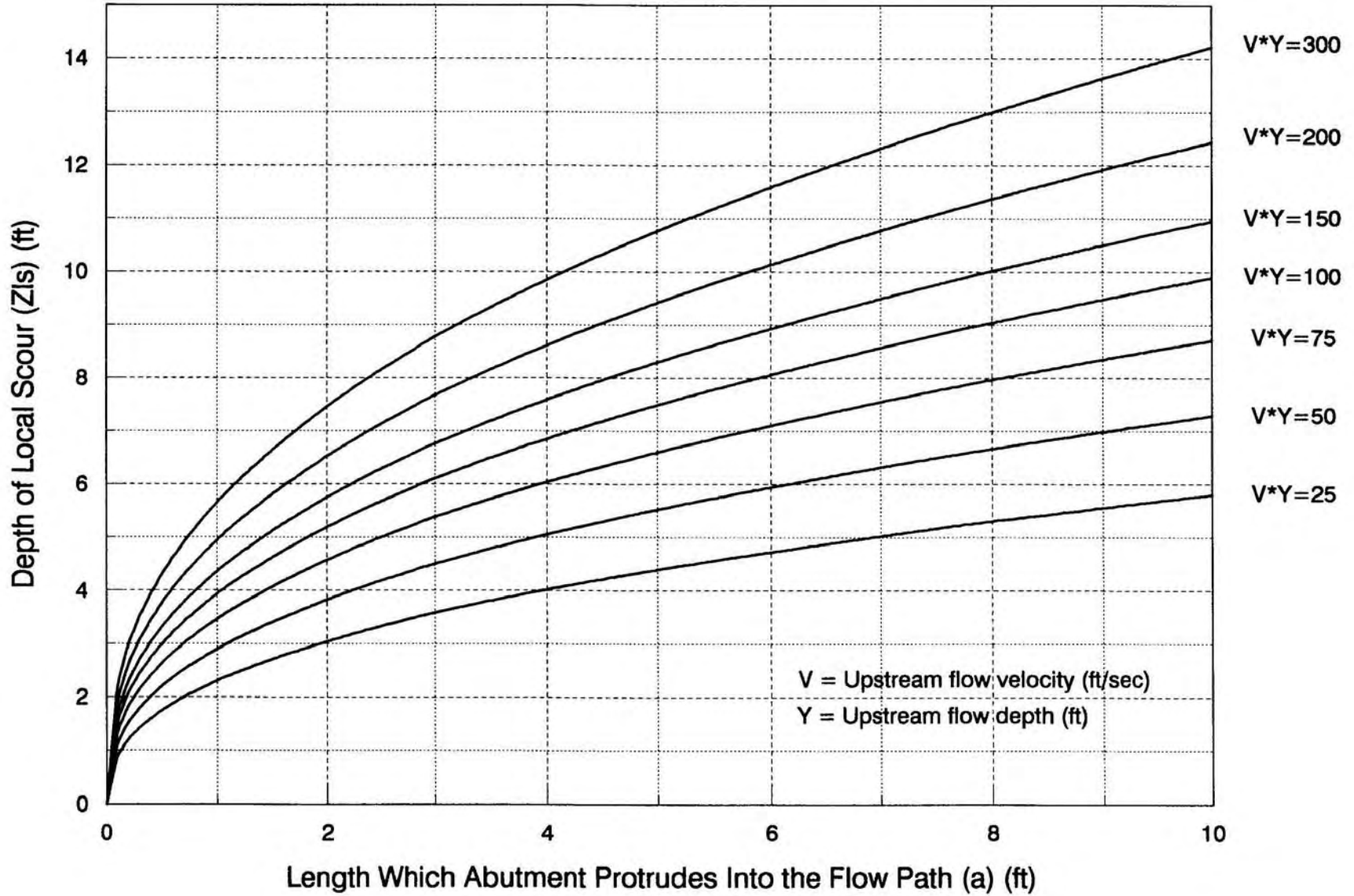

BEND SCOUR

Energy Slope (S_e) = 0.1

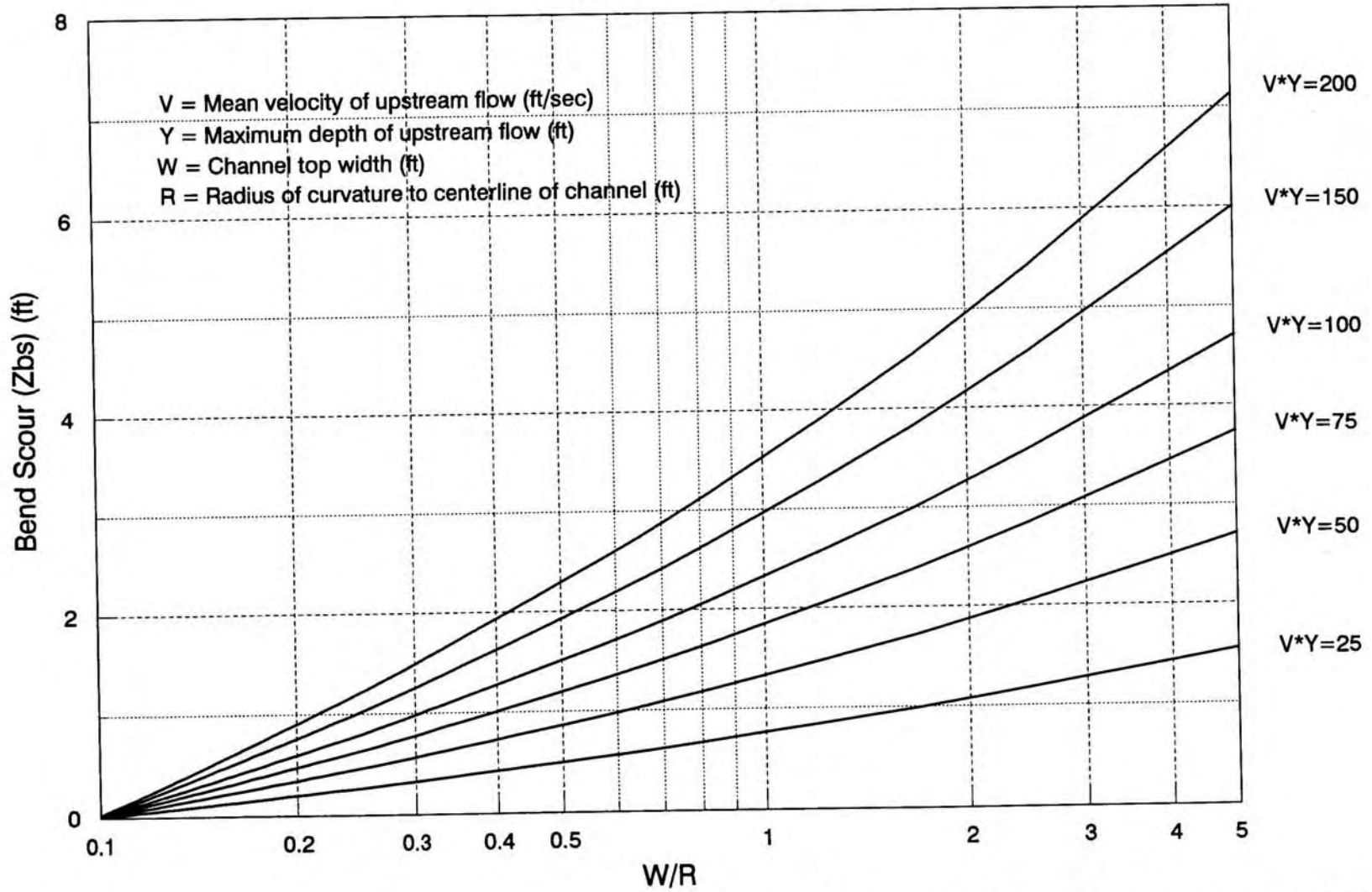

For S_e other than 0.1, 0.01, and 0.001 use linear interpolation or extrapolation

BEND SCOUR

Energy Slope (S_e) = 0.01

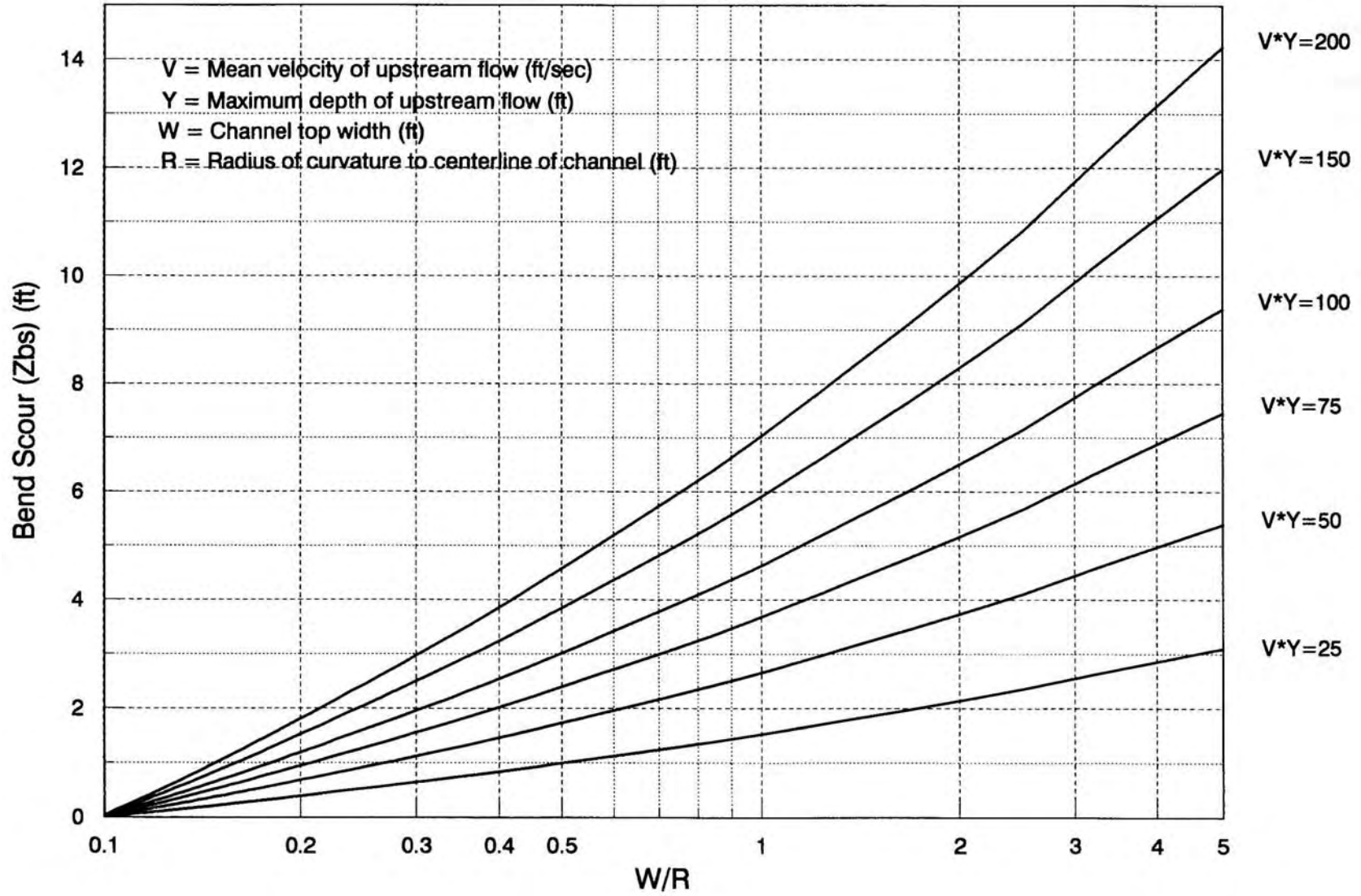

BEND SCOUR

Energy Slope (S_e) = 0.001

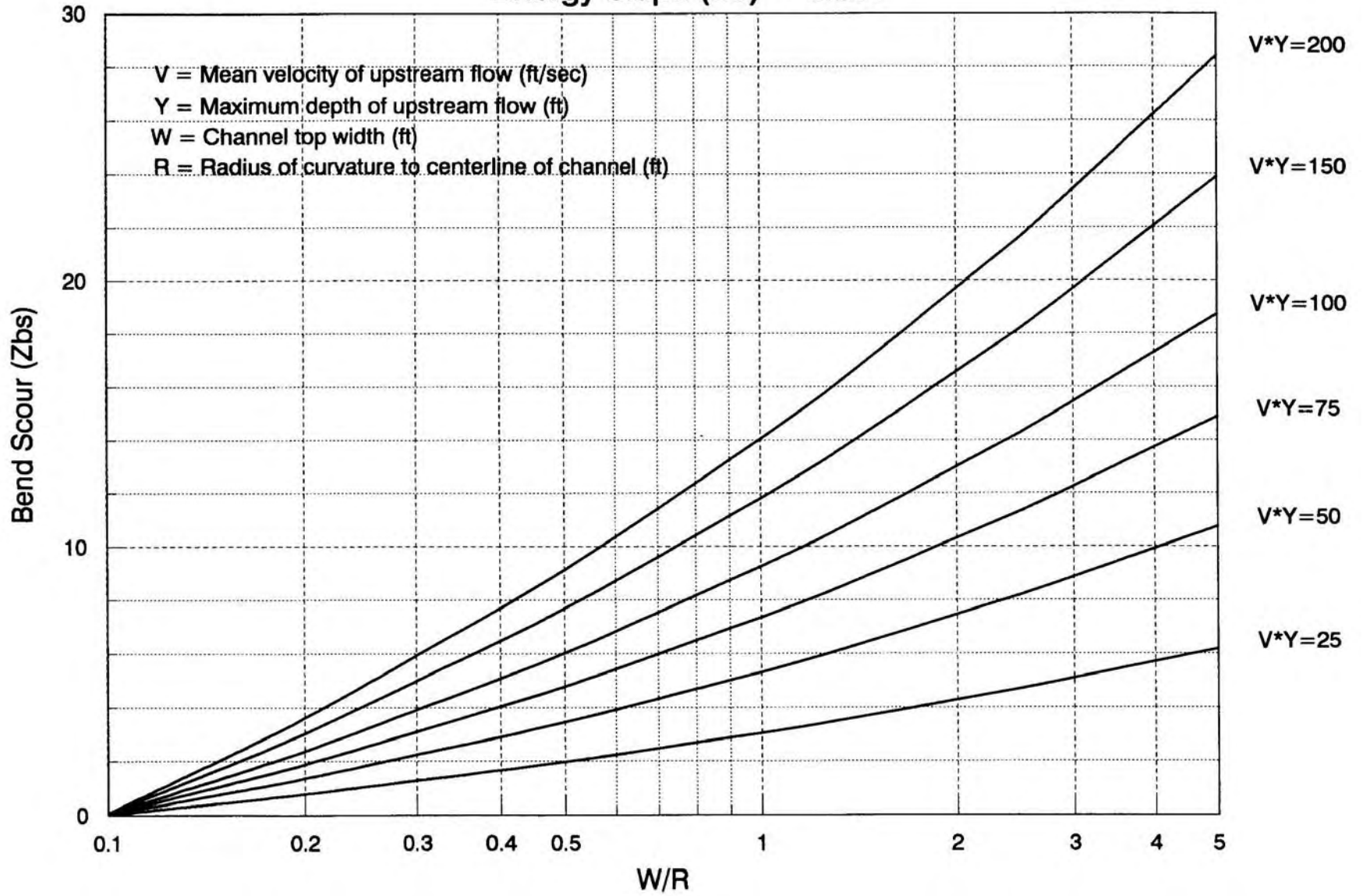

LONGITUDINAL EXTENT OF BEND SCOUR

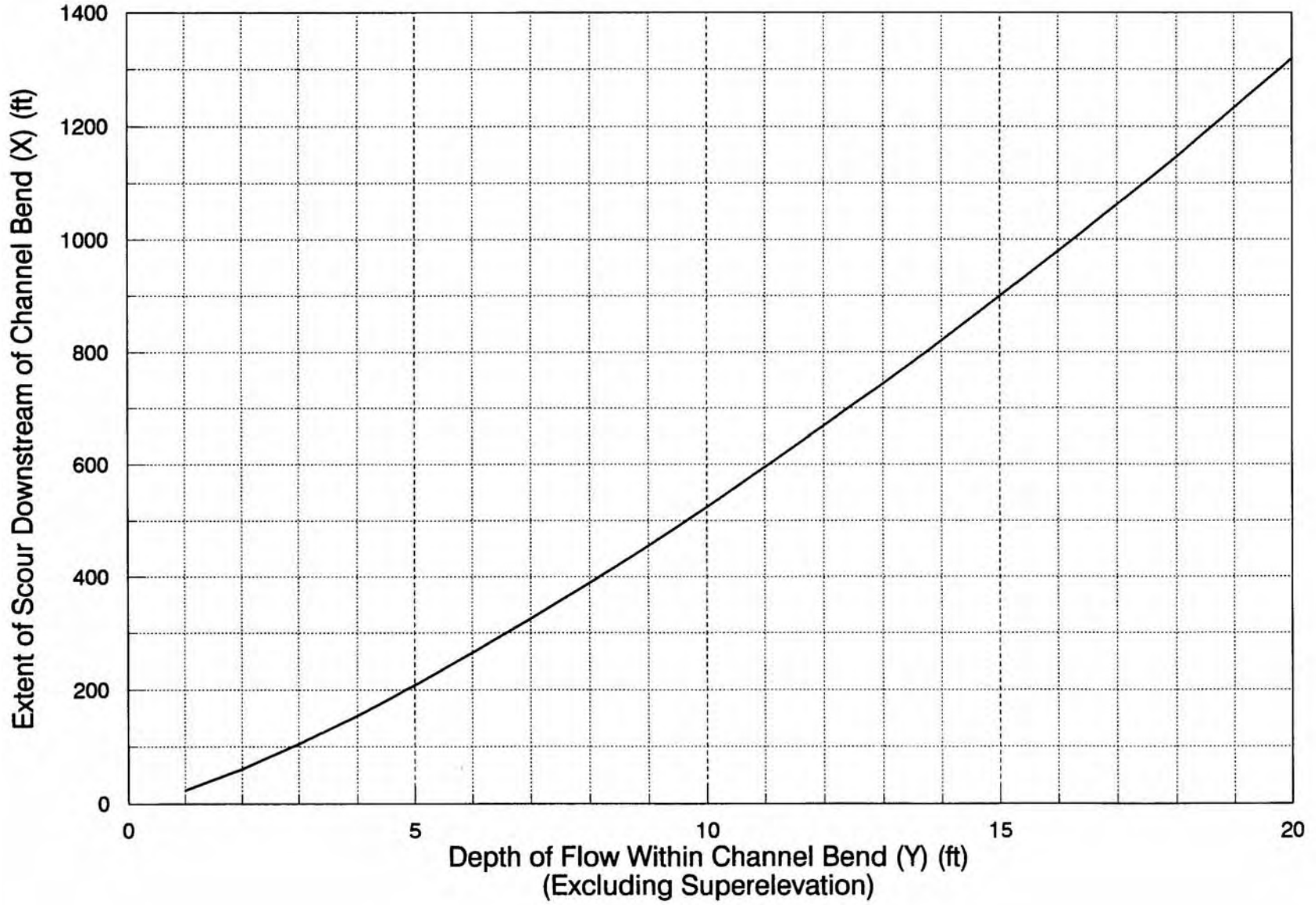

BEDFORM HEIGHT

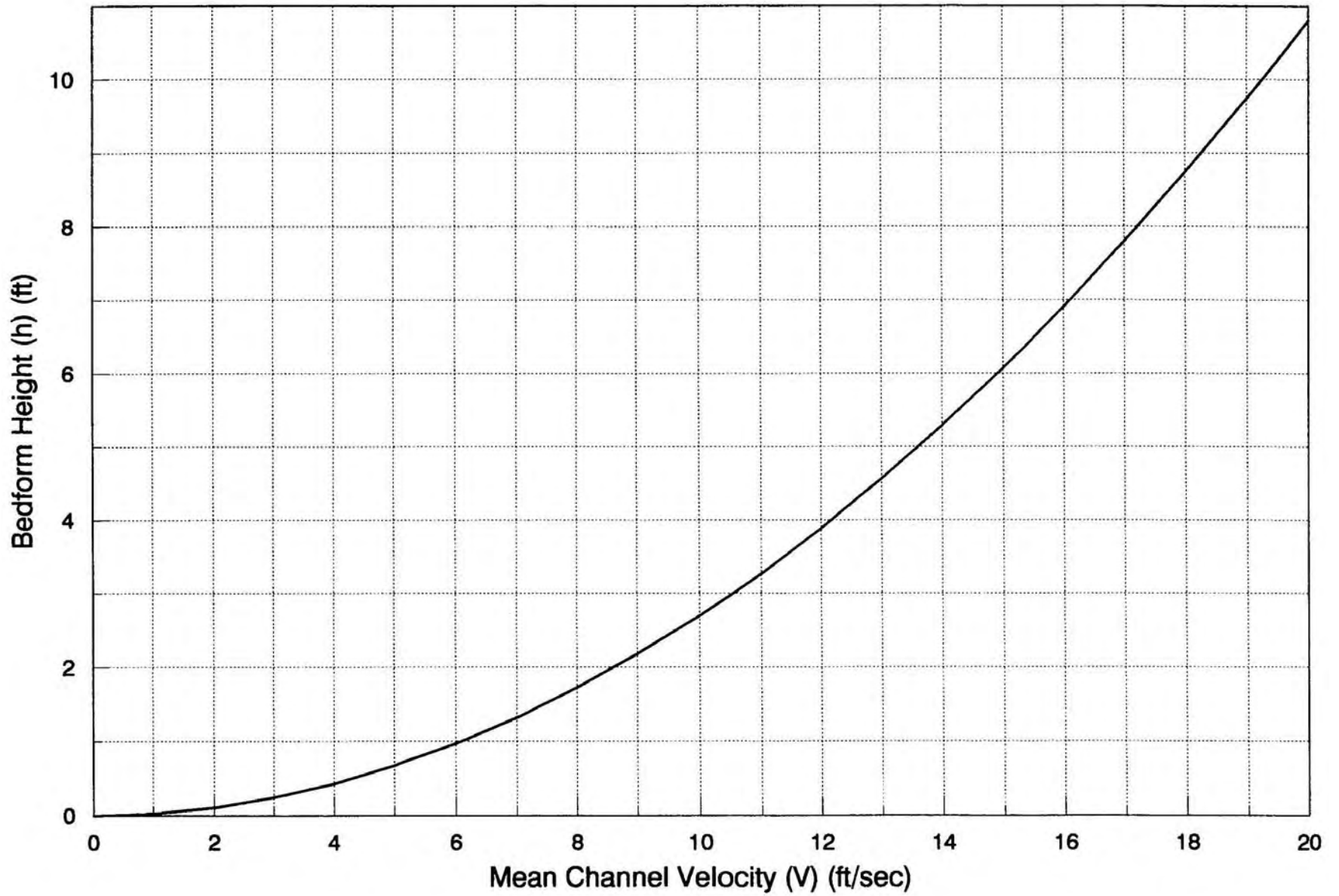

RIPRAP ROCK SIZE

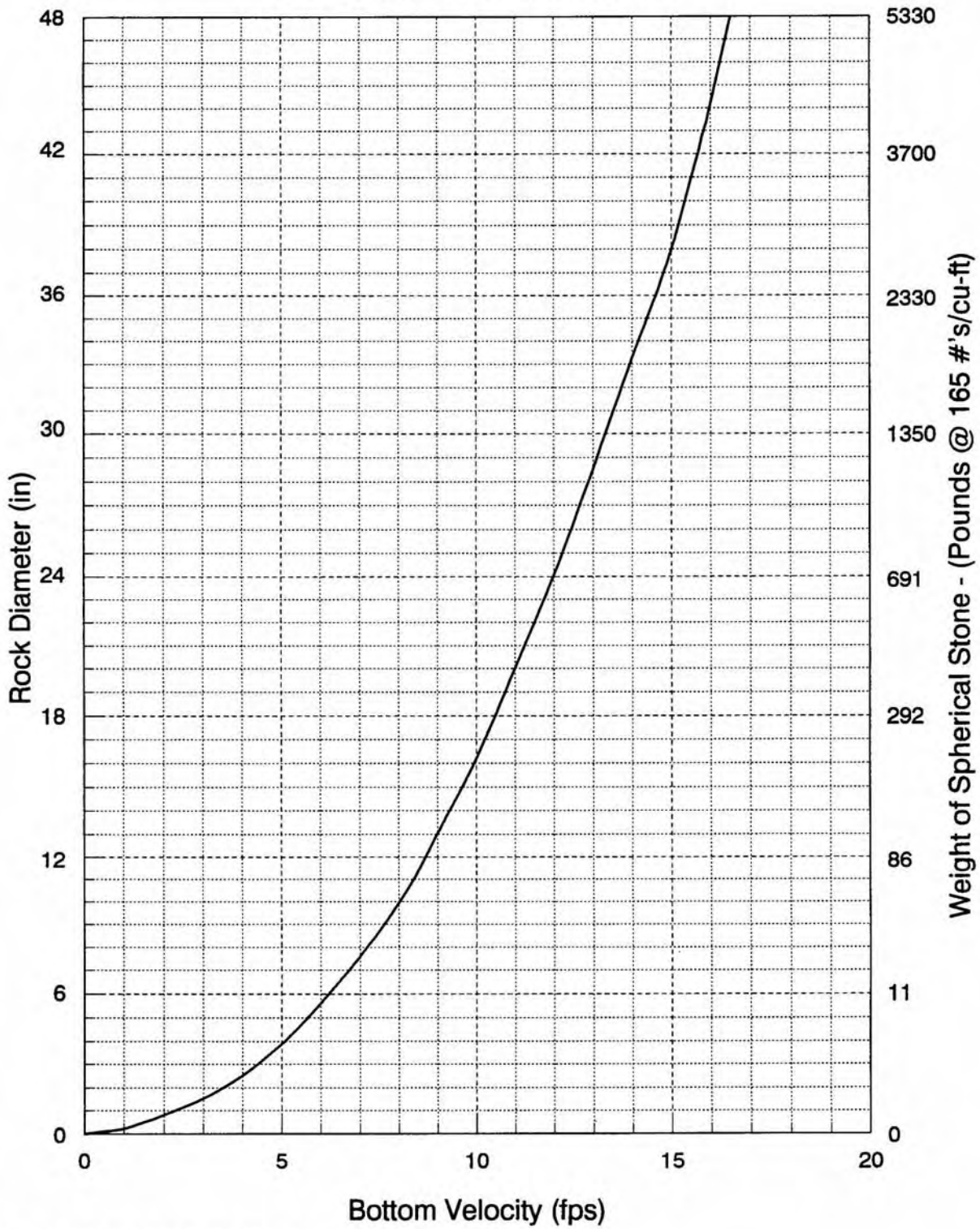

For rock with specific gravity = 2.65

Source: Bureau of Reclamation

LIMITING DEPOSIT VELOCITY

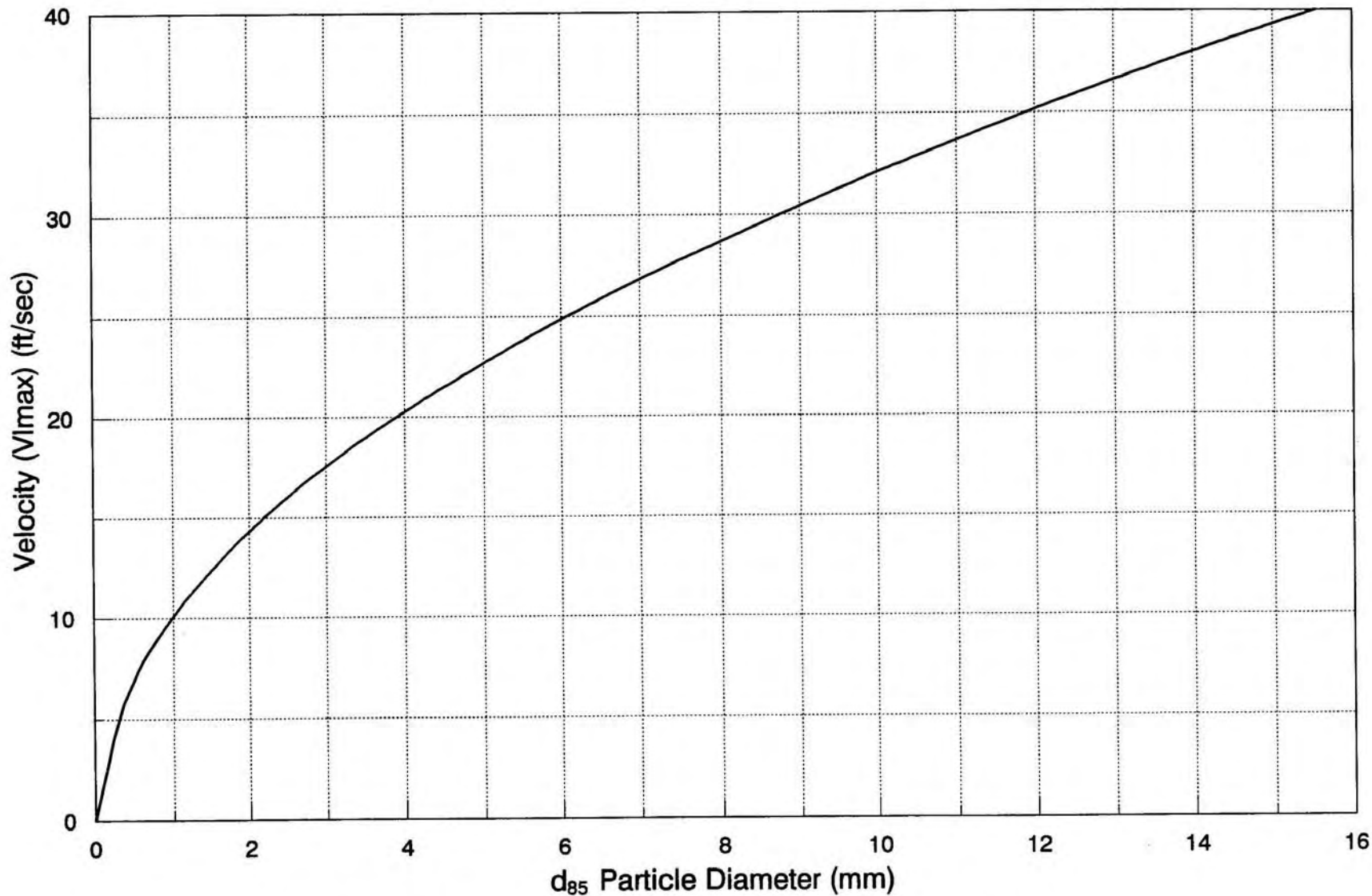

d_{85} = The size of sediment, in mm, for which 85% of the sediment is finer

LIMITING DEPOSIT VELOCITY

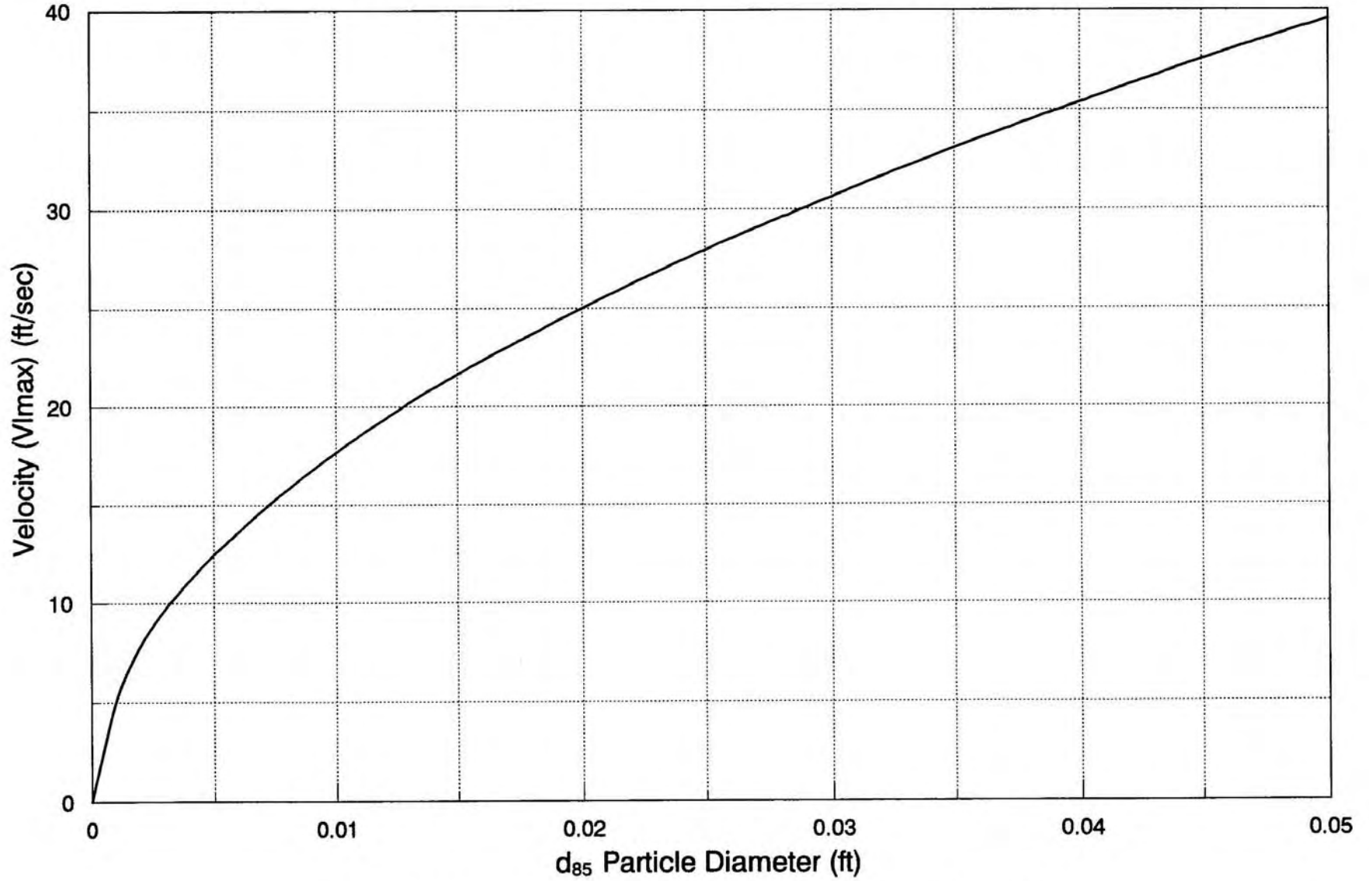

d_{85} = The size of sediment, in ft, for which 85% of the sediment is finer

SEDIMENTATION DESIGN CURVES SOURCE EQUATIONS

Pier Local Scour (Appendix page Q-3):

$$Z_{ls} = (1.04) b^{0.65} V^{0.43} Y^{0.135} \quad (\text{Neill, 1964})$$

where: Z_{ls} = Local scour depth at bridge piers, in feet
 b = Pier width normal to the direction of flow, in feet
 V = Upstream flow velocity, in ft/sec
 Y = Upstream flow depth, in feet.

Abutment Local Scour (Appendix page Q-5):

$$Z_{lsa} = (0.62) a^{0.40} V^{0.33} Y^{0.44} \quad (\text{Lin, 1961})$$

where: Z_{lsa} = Depth of local scour due to an abutment, in feet
 a = Length which abutment protrudes into the flow path, in feet
 V = Upstream flow velocity, in ft/sec
 Y = Upstream flow depth, in feet.

Bend Scour (Appendix page Q- 6A-C):

$$Z_{bs} = \frac{0.0685 Y V^{0.8}}{Y_h^{0.4} S_e^{0.3}} \left[1.59 \left(\frac{w}{r} \right)^{0.2} - 1 \right] \quad (\text{Zeller, 1981})$$

where: Z_{bs} = Bend scour component of total scour depth, in feet
 V = Mean velocity of upstream flow, in ft/sec
 Y = Maximum depth of upstream flow, in feet
 Y_h = Hydraulic depth of upstream flow, in feet
 S_e = Upstream energy slope
 w = Channel top width, in feet
 r = Radius of curvature to centerline of channel, in feet.

Longitudinal Extent of Bend Scour (Appendix page Q-7):

$$X = (0.41) C Y \quad (\text{Rozovski, 1961})$$

- where: X = Distance from the end of channel curvature to the downstream point at which secondary currents have dissipated, in feet
 C = Chezy coefficient (see equation below)
 Y = Depth of flow within the channel bend (not including scour), in feet.

The Chezy coefficient may be determined from the expression:

$$C = \frac{1.486}{n} R^{1/6}$$

- where: n = Manning roughness coefficient for the channel
 R = Hydraulic radius.

Bed form Height (Appendix page Q-8):

$$h = 0.14 \frac{2 \pi V^2}{g} = 0.027 V^2 \quad (\text{Kennedy, 1963})$$

- where: h = Bed form height
 V = Mean channel velocity
 g = Acceleration of gravity.

Limiting Deposit Velocity - d_{85} (Appendix pages Q- 10A-B):

In mm:

$$V_{lmax}^2 = 103 d_{85} \quad (\text{Sinclair, 1962})$$

where: V_{lmax} = Maximum limiting deposit velocity, in ft/sec
 d_{85} = The size of sediment for which 85% of the transported sediment is finer, in **mm**.

In feet:

$$V_{lmax}^2 = 31,300 d_{85} \quad (\text{Sinclair, 1962})$$

where: V_{lmax} = Maximum limiting deposit velocity, in ft/sec
 d_{85} = The size of sediment for which 85% of the transported sediment is finer, in **feet**.

APPENDIX D

Sedimentation Examples

(Refer to the Sedimentation Manual Text)

Debris Production & Bulked Q Example (Example 1)	D1-3
Debris Basin Design Example (Examples 2A and 2B)	D4-11
Levee & Bridge Design Example (Example 3)	D12-18
Invert Stabilization Example (Example 4)	D19-22

Debris Production & Bulked Q Example

WORK MAP

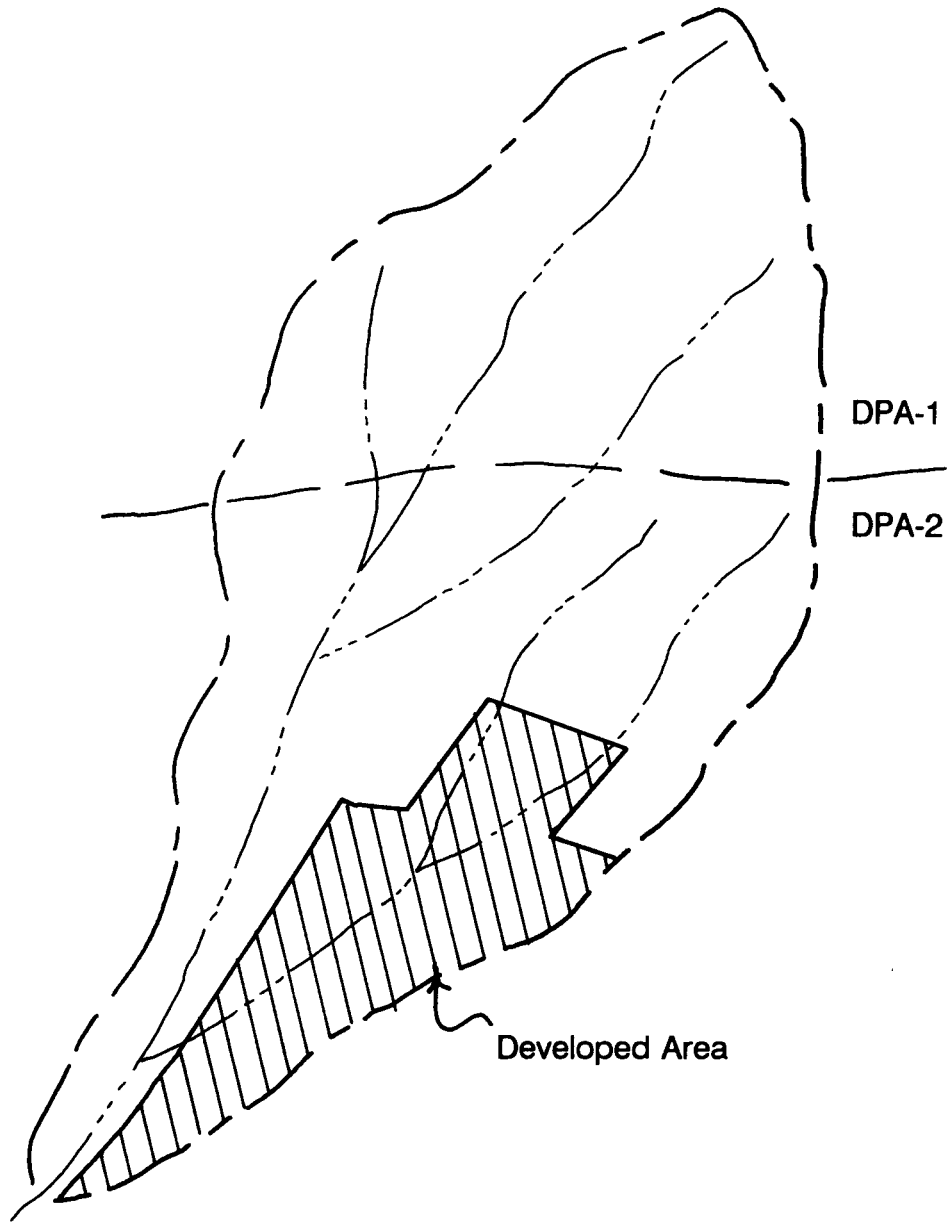

Initials HK	Los Angeles County Department of Public Works
Date 6/17/91	Project Name DEBRIS PRODUCTION & BULKED Q EXAMPLE PROBLEM
Scale NONE	

EXAMPLE 1

DEBRIS PRODUCTION AND BULKED Q EXAMPLE

Given:

Burned Q = 348 cfs
Total Area = 224 acres = 0.35 sq. miles
Developed Area = 45 acres = 0.07 sq. miles

Problem:

Find the total debris production and the bulked Q.

Answer:

1. Calculate the areas for each DPA zone.

DPA Zone	Drainage Area		Developed Area
	Acres	Square Miles	Square Miles
1	77	0.12	0
2	147	0.23	0.07
Total	224	0.35	0.07

2. Determine the debris production rate (DPR) for each DPA zone from Appendix P-3 corresponding to the total drainage area.

For DPA zone 1 (total area = 0.35)

DPR = 155,000 cubic yards per sq. mile

DPA zone 1 (total area in DPA 1 - developed area = 0.12)

DPR = 222,000 cubic yards per sq. mile

DPA zone 2 (total area = 0.35)

DPR = 98,000 cubic yards per sq. mile

DPA zone 2 (total area in DPA 2 - developed area = 0.23 - 0.07 = 0.16)

DPR = 123,000 cubic yards per sq. mile

3. Calculate the total debris production as follows:

$$\begin{aligned}
 DP &= 155,000 (0.12 - 0) \left(\frac{0.12 - 0}{0.12 + 0.23} \right) + 222,000 (0.12 - 0) \left(\frac{0.23 + 0}{0.12 + 0.23} \right) \\
 &\quad + 98,000 (0.23 - 0.07) \left(\frac{0.23 - 0.07}{0.12 + 0.23} \right) + 123,000 (0.23 - 0.07) \left(\frac{0.12 + 0.07}{0.12 + 0.23} \right) \\
 &= 41,734.8 \text{ yd}^3
 \end{aligned}$$

4. Determine the peak bulking factor for each DPA zone from Appendix P-6 and find the Q_{bulked} (Q_B) as follows:

In DPA zone 1:

$$\text{Peak bulking factor for area } A_1 + A_2 = BF_{1(A1+A2)} = 2$$

$$\text{Peak bulking factor for area } A_1 - Ad_1 = BF_{1(A1-Ad1)} = 2$$

In DPA zone 2:

$$\text{Peak bulking factor for area } A_1 + A_2 = BF_{2(A1+A2)} = 1.81$$

$$\text{Peak bulking factor for area } A_2 - Ad_2 = BF_{2(A1-Ad2)} = 1.81$$

$$\begin{aligned}
 Q_B &= 2.00 \left(\frac{348 (0.12 - 0)}{0.12 + 0.23} \right) \left(\frac{0.12 - 0}{0.12 + 0.23} \right) + \\
 &\quad 2.00 \left(\frac{348 (0.12 - 0)}{0.12 + 0.23} \right) \left(\frac{0.23 + 0}{0.12 + 0.23} \right) + \left(\frac{348 (0)}{0.12 + 0.23} \right) + \\
 &\quad 1.81 \left(\frac{348 (0.23 - 0.07)}{0.12 + 0.23} \right) \left(\frac{0.23 - 0.07}{0.12 + 0.23} \right) + \\
 &\quad 1.81 \left(\frac{348 (0.23 - 0.07)}{0.12 + 0.23} \right) \left(\frac{0.12 + 0.07}{0.12 + 0.23} \right) + \left(\frac{348 (0.07)}{0.12 + 0.23} \right) \\
 &= 596 \text{ cfs}
 \end{aligned}$$

Debris Basin Design Example

EXAMPLE 2

DEBRIS BASIN DESIGN EXAMPLE PROBLEM

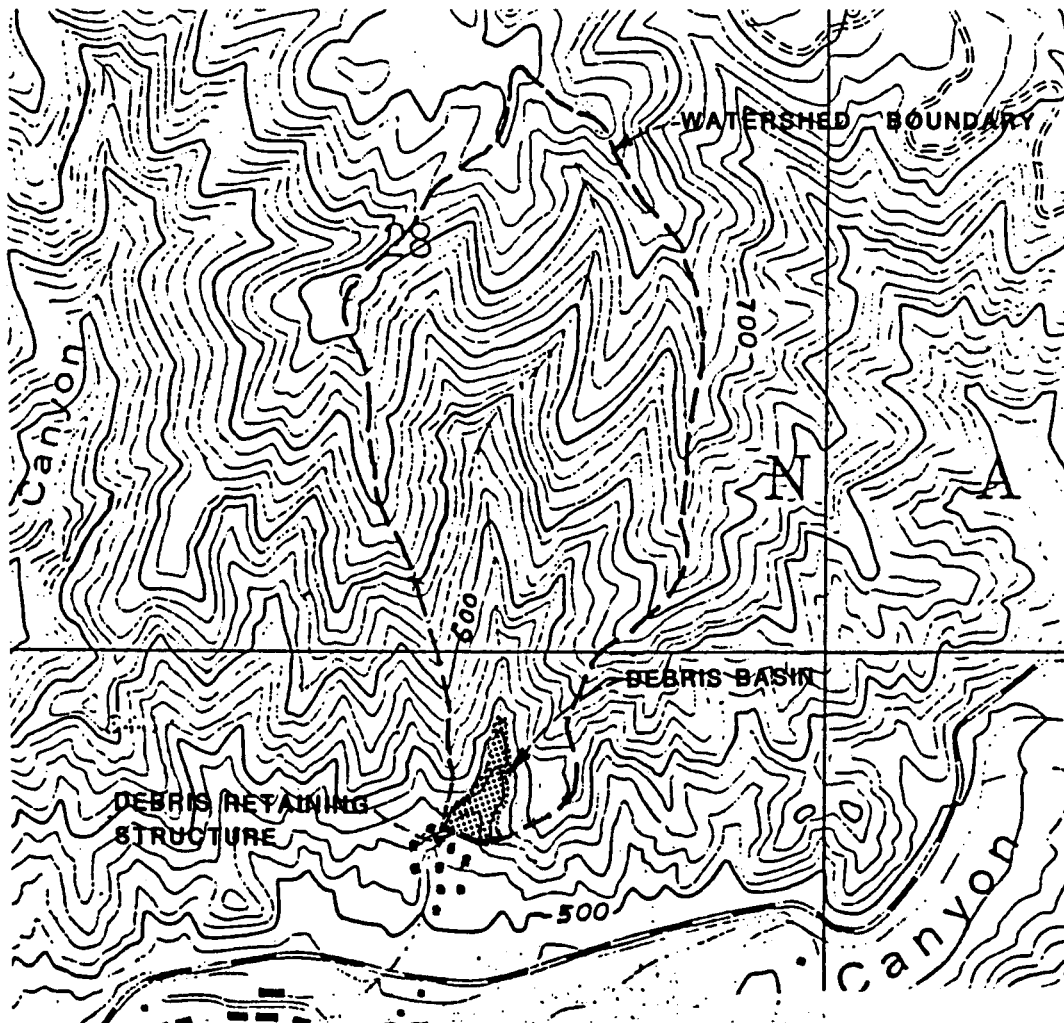

Design a debris basin for the watershed shown above.

The given watershed is in DPA zone 6 and has a tributary area of 0.2 square miles.

The debris production rate for the given watershed is 37,500 cubic yards (see curve on Appendix page P-1).

The Design Debris Event (DDE) is $37,500 \times 0.2 = 7,500$ cubic yards

The DDE is the basis for capacity in designing the Debris Basin. At this point a large scale (20 or 40 feet per inch) topographic map is required. The actual calculation is a trial and error procedure. The designer must select a height for the structure, H_s . Setting this height determines the other dimensions of the basin such as the height of cone, H_C , the natural slope S_N , and the debris slope, S_D .

EXAMPLE 2-A

DEBRIS SLOPE CALCULATION

Given:

Spillway crest elevation,

$$El = 530.7 \text{ ft}$$

Original ground elevation below the spillway,

$$El_g = 517.3 \text{ ft}$$

$$H_s = El - El_g = 530.7 - 517.3 = 13.4 \text{ ft}$$

The cone height:

$$\begin{aligned} H_c &= 2H_s \\ &= 2(13.4) = 26.8 \text{ ft} \end{aligned}$$

The elevation of this point is: $517.3 + 26.8 = 544.1 \text{ ft}$

To determine the length, L (needed to calculate S_N), scale along the stream's natural flow line from the point below the spillway to elevation 544.1 (a distance of 410 feet). Therefore:

$$S_N = \frac{H_C}{L} = \frac{26.8}{410} = 0.0654$$

The cone slope

$$\begin{aligned} S_D &= 0.5 \times S_N \\ &= 0.5 \times 0.0654 = 0.033 \end{aligned}$$

DEBRIS SLOPE CALCULATION

(1.)	Elevation of spillway crest (El.)	530.7
(2.)	Prior elevation of natural ground below spillway (El_g)	517.3
(3.)	Height of spillway above natural ground (H_S): (1) - (2) =	13.4
(4.)	$\Delta EL (H_C) = 2 \times (3) =$	26.8
(5.)	Upstream cone elevation = (2) + (4) =	544.1
(6.)	Horizontal distance from spillway crest to upstream cone elevation (measured along low flow path) (L) =	410
(7.)	Natural slope (S_N) = $\{(4) \div (6)\} \times 100 =$	6.54%
(8.)	Debris cone slope (S_D) = $0.5 \times (7) =$	3.27% (Say 3.3%)

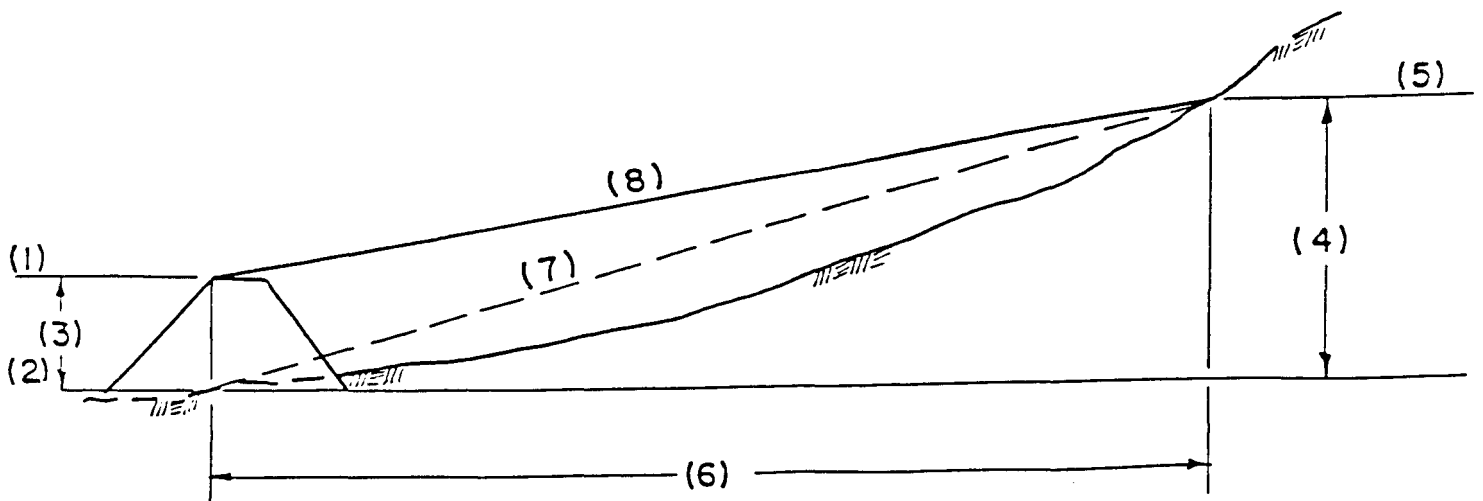

To determine the capacity of the basin thus defined, measure the area behind the dam delineated by each full contour. Maximum contour intervals should be 2 ft for small basins and 5 ft for large basins of 50,000 cubic yards or more. The areas of two contours are averaged, then multiplied by the contour interval to calculate the volume of that slice. Starting at the bottom of the basin, these volumes of the slices are summed until spillway crest is reached. The total volume constitutes the Level Capacity.

The cone lines are located by measuring along the profile which has a slope of 3.3% in this example. To calculate the volume of the debris cone, begin by selecting the cone line at the spillway crest (530.7). The second cone line is selected at elevation 532.0 feet. The first contour interval is thus 1.3 feet. The third and following cone lines will be selected at 2 foot contour intervals and so on until elevation 544.0 feet. Since the highest cone line daylights at elevation 544.1, the last contour interval is only 0.1 foot. After selecting the cone lines, the contour area at each cone line will be planimetered. The areas of two contours are averaged, then multiplied by the contour interval (typically 2 feet in this example, except for the very first and last contour intervals) to calculate the volume of that slice. Starting at the spillway crest, all volumes of slices are summed until the top of cone. The total volume constitutes the cone capacity. The cone capacity is added to the level capacity for the total capacity of the basin (see attached plan on page **R-8**).

If the volume reached is not sufficient for the DDE, then a higher dam must be used, and the calculations repeated as before.

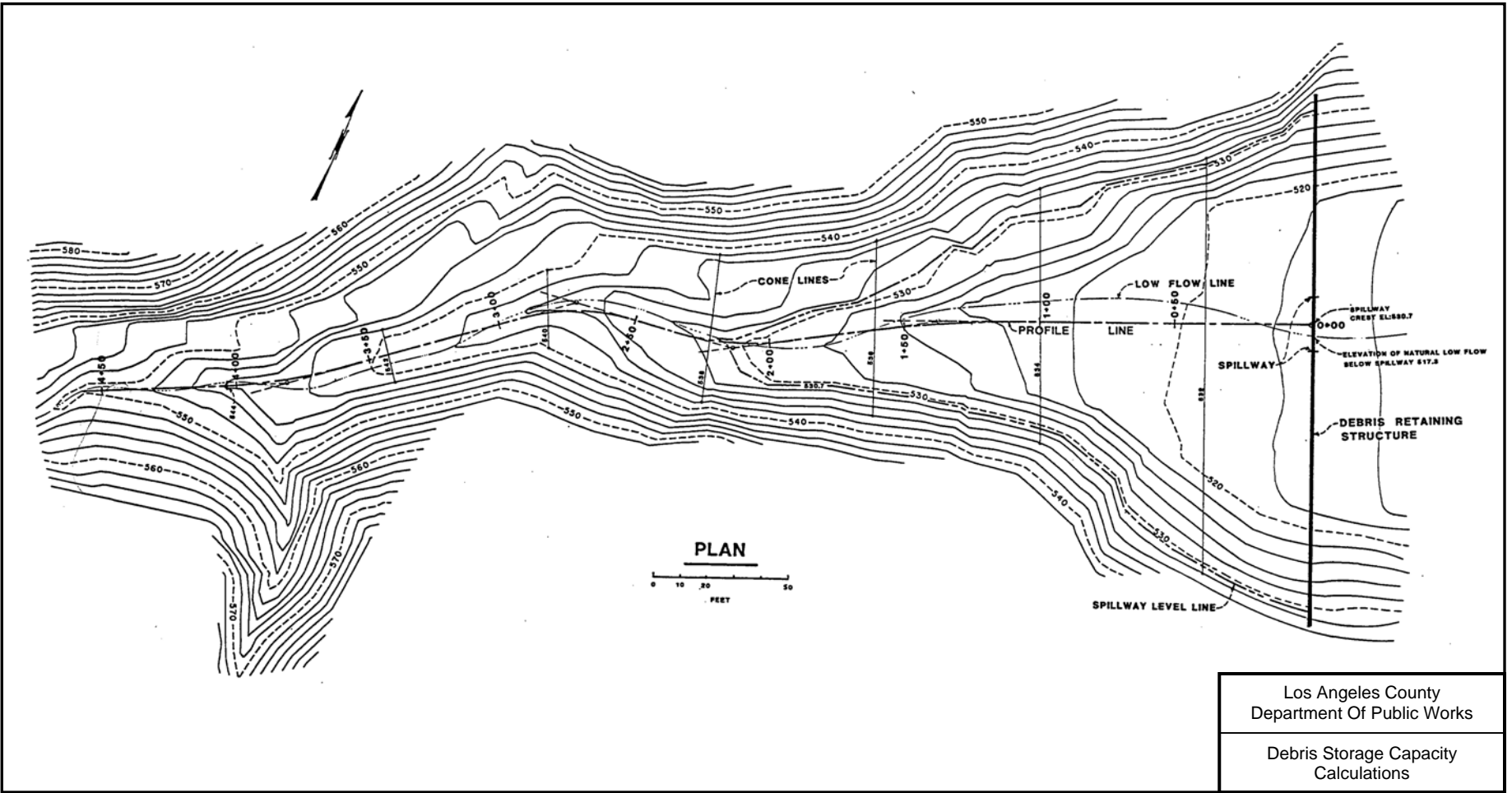

STORAGE CAPACITY CALCULATIONS

ELEVATION (FT)	CONTOUR INTERVAL	AREA (SQ.FT)	MEAN AREA (SQ.FT)	VOLUME (CU.YD)	TOTAL VOLUME (CU.YD)
517.3		0			
	0.7		556	14	14
518.0		1112			
	2.0		3083	228	242
520.0		5054			
	2.0		6685	495	737
522.0		8316			
	2.0		9393	696	1433
524.0		10470			
	2.0		11539	855	2288
526.0		12608			
	2.0		13713	1016	3304
528.0		14818			
	2.0		16052	1189	4493
530.0		17286			
	0.7		17740	460	4953
530.7 spwy		18195			
	1.3		15655	754	5707
532.0		13116			
	2.0		10489	777	6484
534.0		7863			
	2.0		6285	466	6950
536.0		4706			
	2.0		3696	274	7224
538.0		2687			
	2.0		1953	145	7369
540.0		1220			
	2.0		889	66	7435
542.0		558			
	2.0		280	21	7456
544.0		2			
	0.1		1	---	---
544.1		0			
			Storage Capacity		≈7500

EXAMPLE 2-B

DEBRIS SLOPE CALCULATION FOR A TWO-BRANCH STREAM

- | | | |
|------|---|--------|
| (1.) | Elevation of spillway crest (EL) | 993.0 |
| (2.) | Prior elevation of natural ground below spillway (El_g) | 981.6 |
| (3.) | Height of spillway above natural ground (H_S): (1) - (2) = | 11.4 |
| (4.) | $\Delta EL (H_C) = 2 \times (3) =$ | 22.8 |
| (5.) | Upstream cone elevation = (2) + (4) = | 1004.4 |
| (6.) | Horizontal distance from spillway crest to upstream cone elevation (measured along low flow path) (L) | |
| | WEST FORK L = 333 ft | |
| | SOUTH FORK L = 211 ft | |
| (7.) | Natural slope (S_N) = $\{(4) \div (6)\} \times 100$ | |
| | WEST FORK $S_N = 6.85\%$ | |
| | SOUTH FORK $S_N = 10.8\%$ | |
| (8.) | Debris cone slope (S_D) = $0.5 \times (7)$ | |
| | WEST FORK $S_D = 3.4\%$ | |
| | SOUTH FORK $S_D = 5.4\%$ | |
| | Max. Allowable $S_D = 5.0\%$; therefore, SOUTH FORK $S_D = 5.0\%$ | |

Proceed with the rest of the calculations as in Example 2-A.

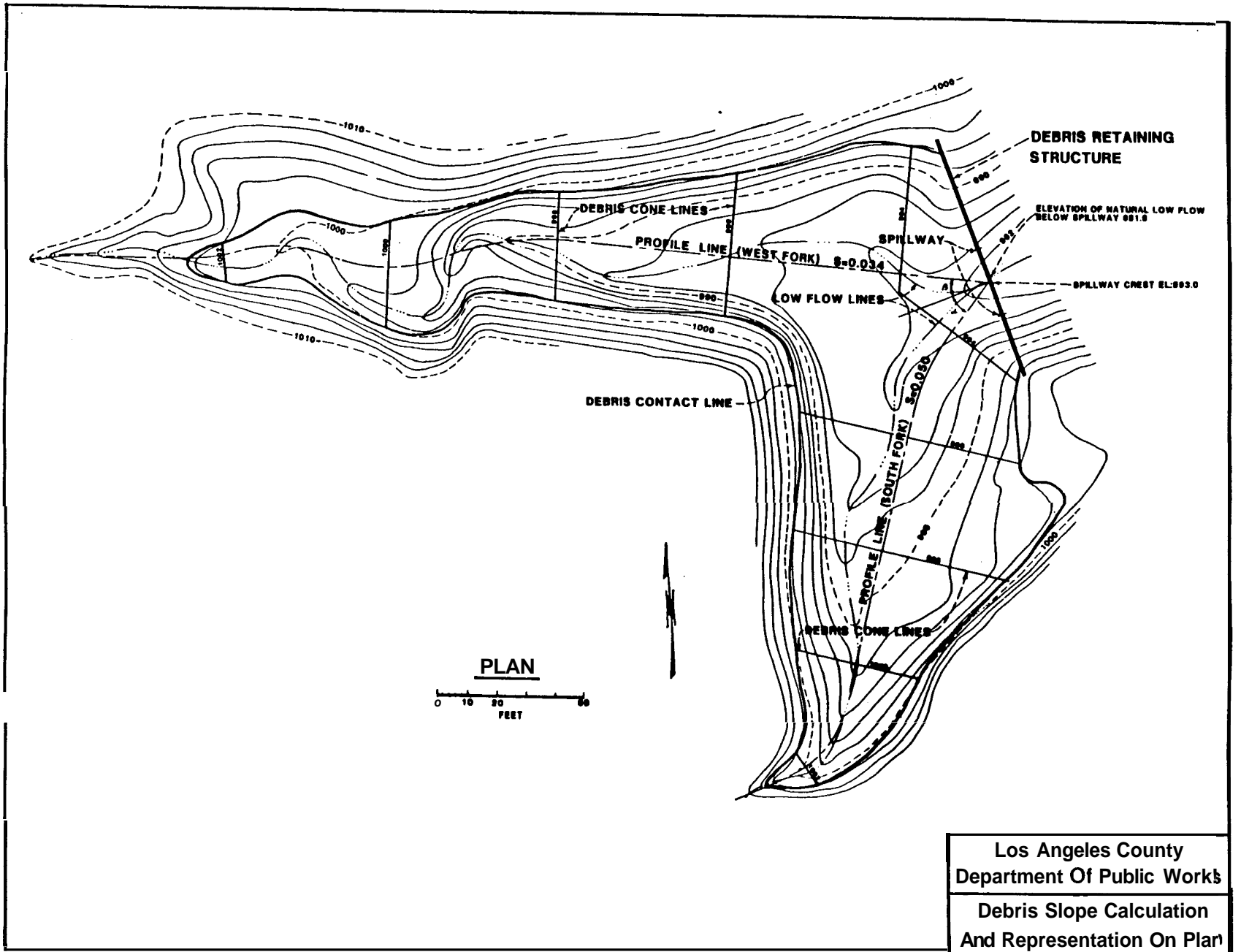

Levee & Bridge Design Example

EXAMPLE 3

LEVEE AND BRIDGE DESIGN EXAMPLE PROBLEM

The following information is given for a proposed channel:

Capital peak discharge, Q_{cap}	-	23,500 cfs
Flow Top width, W	-	450 ft
Radius of curvature, r	=	2400 ft
Length of improvement, L	-	3500 ft
Distance from downstream end of project to the closest grade control	-	1000 ft
Existing slope, S	-	0.007
Channel side slope	-	1½ (H):1(V)
Velocity under existing conditions for Q_{cap}	-	11.8 fps
Velocity under existing conditions for 25% of Q_{cap}	=	7 fps

I. LEVEE DESIGN

1. Levee toe-down (See section 5.A-2 of Sedimentation Manual)

Flow velocity (V) and depth (Y) in the proposed channel were determined by performing a hydraulic analysis using a low Manning's n of 0.025 for the Capital Flood Q and 25 percent of Capital Flood Q .

$$\begin{aligned}V_{cap} &= 12.4 \text{ fps} \\Y_{cap} &= 4.2 \text{ ft} \\V_{25\% \text{ of } cap} &= 7.35 \text{ fps}\end{aligned}$$

a. Long Term Degradation (Z_{deg})

The first step is to determine if invert stabilization is required.

$$\begin{aligned}\text{Percent Increase in Velocity for Capital Flood } Q & \\= 100 ((12.4 - 11.8) / 11.8) & = 5.1\% \\ \text{Percent Increase in Velocity for 25\% of Capital Flood } Q & \\= 100 ((7.35 - 7) / 7) & = 5.0\%\end{aligned}$$

From the graph in Appendix Q-2 for natural slope of 0.007, 5.1% velocity increase, and assuming no reduction in sediment supply, the point of intersection falls below the curve that represents no reduction in sediment supply. Therefore, invert stabilization is not required within the project reach.

The second step is to determine the equilibrium slope for the channel with no reduction in sediment supply. The equilibrium slope for natural slope of 0.007 can be computed by interpolation between $S = 0.005$ and $S = 0.01$.

$$\begin{aligned} \text{For } S = 0.005 & \text{ From Appendix } Q-1A \\ S - S_{eq} &= 0.00035 \\ S_{eq} &= 0.005 - 0.00035 = 0.00465 \\ \text{For } S = 0.01 & \text{ From Appendix } Q-1B \\ S - S_{eq} &= 0.0007 \\ S_{eq} &= 0.01 - 0.0007 = 0.0093 \\ \text{By interpolation with } S = 0.007, & S_{eq} = 0.0065 \end{aligned}$$

Therefore, with natural slope equal to 0.007, the maximum long term degradation in the channelized reach can be computed as follows:

$$Z_{deg} = (3500 + 1000) (0.007 - 0.0065) = 2.25 \text{ ft}$$

b. General Scour (Z_{gs})

From Appendix Q-3 for velocity of 12.4 fps:

$$Z_{gs} = 2.9 \text{ ft}$$

c. Local Scour (Z_{ls})

A typical value of 2 ft was used. (See Section 5.A-2(c).)

d. Bend Scour (Z_{bs})

$$(V)(Y) = (12.4)(4.2) = 52.08$$

$$W/r = 450/2400 = 0.19$$

Assume uniform flow conditions. Therefore $S_e = S_{eq} = 0.0065$ (Refer to Section 5.A-2(d)):

Z_{bs} for $S_e = 0.0065$ can be computed by interpolation between
 $S_e = 0.001$ and $S_e = 0.01$

For $S_e = 0.001$ from Appendix page Q-7C

$$Z_{bs} = 1.2 \text{ ft}$$

For $S_e = 0.01$ from Appendix page Q-7B

$$Z_{bs} = 0.8 \text{ ft}$$

By interpolation with $S_e = 0.0065$, $Z_{bs} = 0.96 \text{ ft}$

To find the extent of bend scour downstream of the bend, use Appendix page Q-8 with depth of flow at the bend = 4.2 ft

$$X = 170 \text{ ft}$$

e. Low Flow Incisement (Z_i)

Since there were no field measurements, a typical value of 2 ft was used. (See Section 5.A-2(e).)

f. Bedform Height (h)

From Appendix page Q-9 bedform height $h = 4.3$ ft for $V = 12.4$ fps

Therefore the levee toe-down was computed as follows:

$$\begin{aligned} Z_{tot} &= Z_{deg} + Z_{gs} + Z_{ls} + Z_{bs} + Z_i + \frac{1}{2}h \\ &= 2.25 + 2.9 + 2 + 0.96 + 2 + 0.5(4.3) = 12.26 \approx 12.3 \text{ ft} \end{aligned}$$

According to the cut-off depth table in the Hydraulic Design Manual, levee toe-down is 15 ft (for a curved reach and a velocity of 12 fps), therefore, use 15 ft cut-off depth.

2. Freeboard (See Section 5.A-3 of Sedimentation Manual)

The channel was assumed to have little vegetation, therefore a higher Manning's n of 0.035 was used to evaluate maximum freeboard. By performing hydraulic analysis for the specific reach, flow velocity and depth were determined to be 11 fps and 4.8 ft, respectively.

$$\text{Freeboard} = Y_{agg} + Y_{ga} + Y_{se} + \frac{1}{2}h$$

Since this channel is degrading (see 1(a) of this example):

$$\begin{aligned} Y_{agg} &= 0 \\ Y_{ga} &= 0 \end{aligned}$$

Compute superelevation, using the criteria in the Hydraulic Design Manual. The flow is subcritical and the velocity $V = 11$ fps is less than 35 fps, therefore:

$$Y_{se} = \frac{1.15(W)V^2}{2gr}$$

$$= \frac{1.15(450)11^2}{(2)(32.2)(2400)} = 0.41 \text{ ft}$$

where: g = Acceleration of gravity = 32.2 ft/sec²

From Appendix page Q-9 bedform height $h = 3.3$ ft for $V = 11$ fps

Therefore the freeboard was computed as follows:

$$\text{Freeboard} = Y_{agg} + Y_{ga} + Y_{se} + \frac{1}{2}h$$

$$= 0 + 0 + 0.41 + 0.5(3.3) = 2.06 \approx 2.1 \text{ ft}$$

According to section C-4.2 in the Hydraulic Design Manual, for average flow velocity of 35 fps or less, the freeboard is 2.5 ft. Therefore use 2.5 ft freeboard.

II. BRIDGE DESIGN

Find the total pier scour and abutment scour for a proposed bridge in a straight reach of the proposed channel given the following additional information:

Pier width, b	= 3 ft
Pier angle of attack	= 15 degrees
Pier length, L	= 15 ft
Length abutment protrudes into the flow, a	= 7 ft
Pier type	= Round Nose

The channel was assumed to have little vegetation, therefore debris blockage was assumed to be two feet.

Flow velocity, V (13.0 feet), and depth, Y (4.0 feet), at the proposed bridge section were determined by performing a hydraulic analysis using a low Manning's n of 0.025 and pier width of $3 + 2 = 5$ feet.

1. Pier scour

From Appendix page Q-4, for $V = 13$, pier local scour $Z_{ls} = 8.7$ ft

The reduction factor (K_1) for round nose piers from the Sedimentation Manual Table 5.1 is 0.9

$$L/b = 5$$

Therefore the multiplying factor (K_2) for a 15° angle of attack from Appendix page Q-5 = 1.7

Adjustment for debris blockage:

$$\begin{aligned} K_3 &= \left(\frac{b + d}{b} \right)^{0.65} \\ &= \left(\frac{3 + 2}{3} \right)^{0.65} = 1.40 \end{aligned}$$

$$\begin{aligned} \text{Net pier local scour} &= Z_{ls} \times K_1 \times K_2 \times K_3 \\ &= 8.7 \times 0.9 \times 1.7 \times 1.4 = 18.6 \text{ ft} \end{aligned}$$

$$\begin{aligned} Z_{tot} &= Z_{deg} + Z_{gs} + Z_{ls} + Z_{bs} + Z_i + \frac{1}{2}h \\ &= 2.25 + 2.9 + 18.6 + 0 + 2 + 0.5(4.3) = 27.9 \\ \text{use } Z_{tot} &= 28 \text{ ft} \end{aligned}$$

2. Abutment Scour

From Appendix page Q-6 with $(V)(Y) = (13)(4) = 52$ and the length the abutment protrudes into the flow equal to 7 feet, abutment local scour equals 6.4 feet and:

$$\begin{aligned} Z_{tot} &= Z_{deg} + Z_{gs} + Z_{ls} + Z_{bs} + Z_i + \frac{1}{2}h \\ &= 2.25 + 2.9 + 6.4 + 0 + 2 + 0.5(4.3) = 15.7 \\ \text{use } Z_{tot} &= 16 \text{ ft} \end{aligned}$$

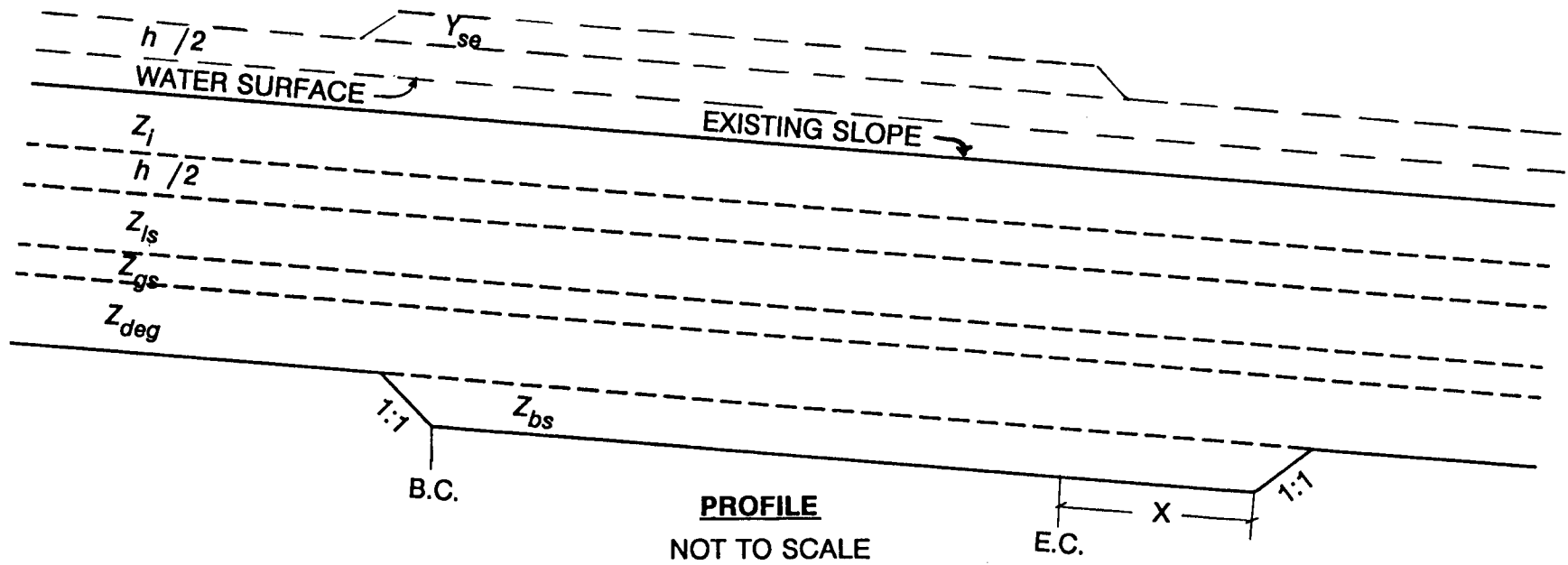
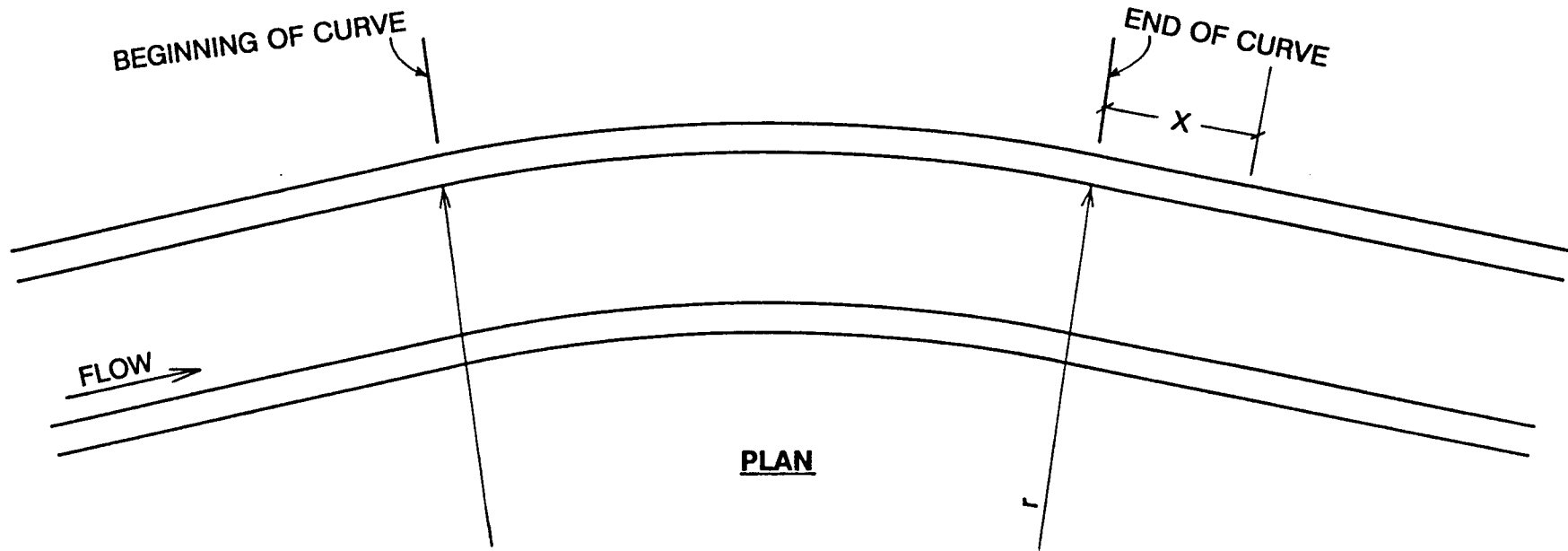

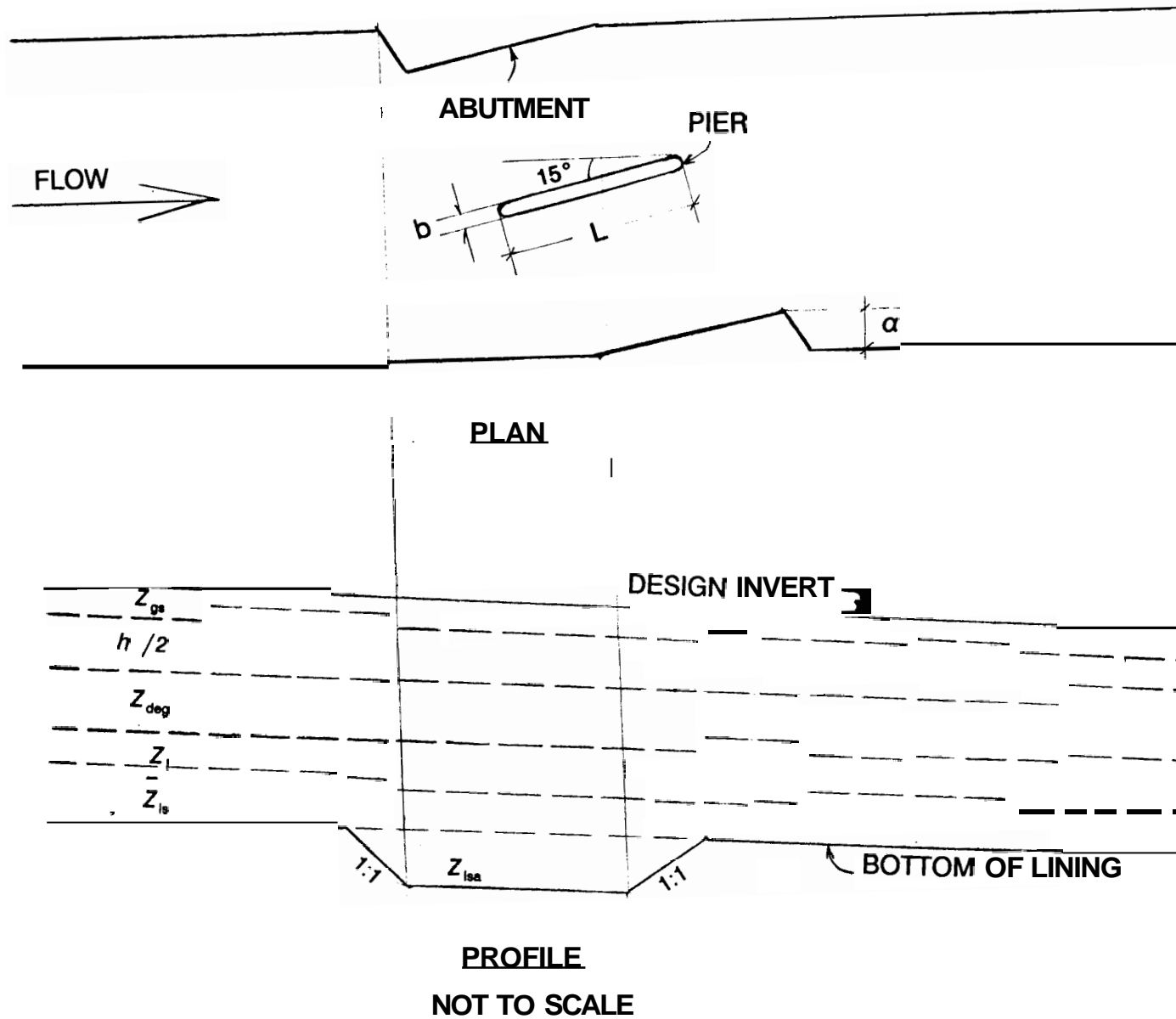

Pier & Abutment Scour

Invert Stabilization Example

EXAMPLE 4

INVERT STABILIZATION EXAMPLE FOR A SOFT BOTTOM CHANNEL

Given:

Natural stream slope, S	= 0.01
Peak discharge, Q_{cap}	= 57,200 cfs
25% of Q_{cap} , Q'_{cap}	= 14,300 cfs
Natural channel bottom width	= 700 ft
Proposed channel bottom width, b	= 360 ft
Average velocity under existing conditions for Q_{cap} , V_{ex}	= 16.8 fps
Velocity after project condition for Q_{cap} , V_p	= 21.4 fps
Average velocity under existing condition for 25% of Q_{cap} , V'_{ex}	= 9.7 fps
Velocity after project condition for 25% of Q_{cap} , V'_p	= 12.5 fps

An existing gravel mining operation upstream of the study reach traps approximately 2/3 of the sediment supply.

The first step is to determine if invert stabilization is required.

$$\begin{aligned} & \text{Percent increase in velocity due to } Q_{cap}, AV \\ \Delta V &= 100 \left(\frac{V_p - V_{ex}}{V_{ex}} \right) = 100 \left(\frac{21.4 - 16.8}{16.8} \right) = 27\% \end{aligned}$$

$$\begin{aligned} & \text{Percent increase in velocity due to } Q'_{cap}, AV' \\ \Delta V' &= 100 \left(\frac{V'_p - V'_{ex}}{V'_{ex}} \right) = 100 \left(\frac{12.5 - 9.7}{9.7} \right) = 29\% \end{aligned}$$

Since $\Delta V'$ is greater than ΔV , a velocity increase of 29% is used to determine if invert stabilization is required.

From the graph in Appendix Q-2, for 29 percent velocity increase and natural slope of 0.01, the point of intersection falls above the curve representing 2/3 reduction in sediment supply. Therefore, invert stabilizers such as point stabilizers or drop structures are required.

To find the equilibrium slope, use the graph in Appendix Q-1 for 29 percent increase in velocity and 2/3 reduction in sediment supply to get:

$$\begin{aligned} \text{Natural slope} - \text{Equilibrium slope} &= 0.0068 \\ S - S_{eq} &= 0.0068 \\ S_{eq} &= 0.01 - 0.0068 = 0.0032 \end{aligned}$$

Use Equation 5.6 to calculate the spacing of the drop structures or point stabilizers.

- a. For drop structures:

$$\text{Nominal height} = 5 \text{ ft}$$

$$\begin{aligned} D &= \frac{H}{(S_0 - S_{eq})} \\ &= \frac{5}{(0.01 - 0.0032)} \\ &= 735 \text{ ft} \end{aligned}$$

- b. For point stabilizers:

$$\text{Nominal height} = 2 \text{ ft}$$

$$\begin{aligned} D &= \frac{H}{(S_0 - S_{eq})} \\ &= \frac{2}{(0.01 - 0.0032)} \\ &= 294 \text{ ft} \end{aligned}$$

To find the riprap size, compute the velocities immediately downstream of the structures for Q_{cap} . In this example, the velocity downstream of the drop structure was 15 fps and

downstream of the point stabilizer was 21 fps. This was determined through hydraulic analysis using a Manning's n equal to 0.025 for the invert. The velocity for the drop structure was computed using the equilibrium slope, and the natural slope was used for the point stabilizers which are constructed at grade.

From Appendix Q-10 the minimum riprap diameter for the drop structure is 38 inches and for the point stabilizer is 48 inches.

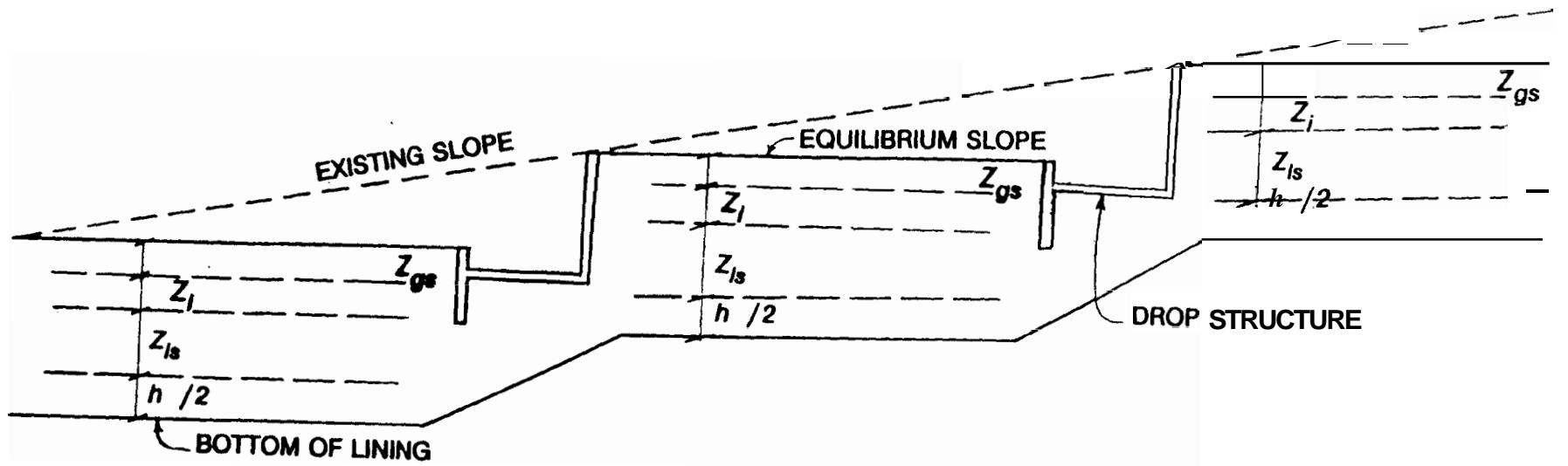

PROFILE
NOT TO SCALE

Drop Structure

APPENDIX E

Comparison of Design Criteria
for Debris Basins, Elevated Inlets, and Desilting Inlets

	Debris Basin ¹	Elevated Inlet	Desilting Inlet
General Location	N/A	Locate both facilities such that if overflow occurs on a street or other safe path, it is available to convey the water and sediment.	
Horizontal alignment	Locate in the original watercourse, where the dam is perpendicular to the flow path. The longer dimension of the basin shall fall along the flow line.		
Outlet Tower and Conduit	Refer to the section on Outlet Works in the Department's Debris Dams and Basins Design Manual.	A standard concrete outlet tower and conduit is required (see the Debris Dams and Basin Design Manual), except in phased upstream development where corrugated metal pipe (CMP) tower with a concrete base may be substituted. ²	A corrugated metal pipe outlet tower and pipe is required upstream of the desilting wall.
Gage Boards	Gage boards are required on basins under State Jurisdiction. Sediment lines painted on towers, marking from the lowest port invert suffice for all others. See the section on Gage Board Pipe Support in the Department's Debris Dams and Basins Design Manual.	Gage boards or sediment lines painted on towers, marking from the lowest port invert can be used.	
Earth Embankment	Upstream and downstream embankment slopes less than or equal to 3H:1V. Steeper slopes require complete geotechnical stability analysis. Also, refer to the section on Earthen Dam Design in the Department's Debris Dams and Basins Design Manual.	Maximum berm slope is 3H:1V. Steeper slopes require complete geotechnical stability analysis. Also, refer to the section on Earth Dam Design in the Department's Debris Dams and Basins Design Manual.	Protect the earth embankment between the desilting wall and the inlet with reinforced concrete facing slab (air placed concrete is acceptable).
Embankment Crest	The top width of the berm over the inlet shall be 20-feet paved 3 inches of asphalt concrete. A berm width of 15-feet may be approved if geological analysis is provided to support the reduction.		
Facing Slab	6-inch concrete or gunite with No. 5 reinforcing steel at 18-inch spacing each way. See section on Earthen Dam Design, Protection for Dam Slopes in the Department's Debris Dams and Basins Design Manual.	A 6-inch thick reinforced concrete facing slab with reinforcing steel (no wire mesh) extending to the canyon wall is required (air placed concrete is acceptable). Provide facing slabs around the basin wall if cut and fill method is used to obtain the capacity.	
Trash Barriers	Refer to the section on Debris Barrier in the Department's Debris Dams and Basins Design Manual.	A swinging trash rack is required for conduits greater than 48-inches in diameter. A sloping trash rack ³ per LACDPW ⁴ 3089-0 can be used for smaller conduits. Trash posts spaced at 4-feet or 2/3 the diameter of the conduit, whichever is smaller, are also required at all elevated inlets.	A sloping trash rack per LACDPW 3089-0 and trash posts spaced at 2/3 the diameter of the conduit are required.
Access Roads	Access roads with 12 ft wide paving (3-inch asphalt concrete on 4-inch crushed aggregate base) within a 15-ft easement with minimum radius of 40 feet can be used for structures with capacity less than 20,000 cubic yards. See section on Access to Dam and Basin in the Department's Debris Dams and Basins Design Manual.	Provide a vehicular access road into the basin at least 12-feet wide within a 15-foot easement, paved with 3 inches of asphalt concrete over 4 inches of crushed aggregate base.	

	Debris Basin ¹	Elevated Inlet	Desilting Inlet
Access Ramps	Ramps are required. Refer to the section on Access to Dam and Basin in the Department's Debris Dams and Basins Design Manual. Unpaved ramps for slopes less than 10 percent. Paved ramps (3-inch asphalt concrete on 4-inch crushed aggregate base) for slopes up to a maximum of 12 percent.		
Fencing	Refer to the section on Fencing in the Department's Debris Dams and Basins Design Manual. Totally, secure the basin area and inlet by 5-foot high fencing per APWA ⁵ standard drawing 600-0.		
Hydraulic Design	Refer to the section on Design of Rectangular Spillway in the Department's Debris Dams and Basins Design Manual.	Base the hydraulic design of inlet and storm drain on requirements stated in the Department's Hydraulic Design Manual.	
Ponding	Refer to the section on Design of Rectangular Spillway in the Department's Debris Dams and Basins Design Manual.	Maximum allowable ponding at the drain shall be 3-feet above soffit of the conduit inlet.	Maximum allowable ponding at the desilting wall shall be 3-feet above soffit of the drain.
Freeboard	Refer to the section on Design of Rectangular Spillway in the Department's Debris Dams and Basins Design Manual.	Minimum freeboard at the inlet is 2-feet above maximum water surface elevation.	
Drain Size	Refer to the section on Design of Rectangular Spillway in the Department's Debris Dams and Basins Design Manual.	Minimum drain size is 36-inch RCP and maximum drain size is 84-inch RCP or equivalent RC Box.	Minimum drain size is 36-inch and maximum drain size is 48-inch RCP or equivalent RC Box.
Inlet Design Capacity	Refer to the section on Design of Rectangular Spillway in the Department's Debris Dams and Basins Design Manual.	Design inlet and storm drain to convey the burned flow rate or the fully developed watershed flow rate, whichever is higher.	Design the spillway notch and the inlet to pass the burned flow rate or the fully developed watershed flow rate whichever is higher.
Structural Design	Refer to the section on Structural Design in the Department's Debris Dams and Basins Design Manual. Contact Design Division for additional information.		
Sediment Capacity	Refer to the section on Basin Capacity in the Department's Debris Dams and Basins Design Manual.	19,999 cubic yards of sediment is the maximum allowable capacity in DPA 5-11 and 4,999 cubic yards is the maximum allowable capacity in DPA zones 1-4.	4,999 cubic yards of sediment is the maximum allowable capacity in DPA zones 5-11 and 999 cubic yards is the maximum allowable capacity in DPA zones 1-4.
Desilting Wall Height	N/A	N/A	The maximum desilting wall height is 6-feet.
Desilting Wall Design	N/A	N/A	Design the desilting wall to withstand the overflow of the total burned and bulked flow rate.

¹ Criteria listed in this table for debris basins amends the criteria given in the Department's Debris Dams and Basins Design Manual.

² The tower base can be modified to include a cleanout drain with a cover plate to allow flushing of the conduit. Extend the encasement on the conduit to the junction with the mainline or to a point where a 3H:1V slope originating from the intersection of the upstream face and the design headwater elevation meets the conduit, whichever is lesser.

³ Discuss with Design Division prior to using a sloping trash rack especially in locations where organic debris may present a significant problem and may lead to clogging up the trash rack.

⁴ Standard plans designated by an LACDPW number refer to the Department's Standard Plan Manual (1992 Edition).

⁵ Standard plans designated by an APWA number refer to the Standard Plans for Public Works Construction Manual by the American Public Works Association, 1985 Edition.

APPENDIX F

Requirements for Design
of Closed Conduits Carrying Bulked Flow

	Open Concrete Channel	Bulked Flow Inlet with Closed Conduit
General Location	N/A	Do not locate a closed conduit drain under homes or other permanent structures. Provide a safe secondary overflow path for water and sediment.
Horizontal Alignment	N/A	The horizontal alignment of the storm drain shall be straight. ¹
Trash Barrier	N/A	A trash rack per LACDPW 3089-0 is required at the inlet. Trash posts spaced at 2/3 the diameter of the conduit or 4 feet, whichever is smaller, are also required.
Access Roads	Provide a vehicular access road of at least 12-feet wide within a 15-foot easement, paved with 3 inches of asphalt concrete (A.C.) over 4 inches of crushed aggregate base (C.A.B.) on both sides of the channel.	Provide a vehicular access road of at least 12-feet wide within a 15-foot easement, paved with 3 inches of asphalt concrete (A.C.) over 4 inches of crushed aggregate base (C.A.B.).
Hydraulic Design	Refer to the Department's Hydraulic Design Manual.	Refer to the Department's Hydraulic Design Manual. Pressure flow is not permitted in closed conduits.
Ponding	N/A	Ponding is not allowed at the inlet.
Freeboard	Refer to the Department's Hydraulic Design Manual.	Minimum freeboard at the inlet is 2-feet above maximum water surface elevation. Minimum freeboard to the soffit of the conduit is 1-foot.
Design Capacity	Channel or inlet and drain must be sized to pass the burned and bulked flow rate or the fully developed watershed flow rate whichever is higher.	
Drain Size	N/A	Minimum drain size is 36-inch RCP.
Drain Slope	N/A	The minimum drain slope shall be 5 percent. The slope shall be uniform to maintain uniform velocities. ²
Structural Design	Refer to the Department's Structural Design Manual requirements for sediment carrying channels and conduits in regard to additional cover over the reinforcing steel.	
Minimum and Maximum Velocities	Peak flow velocity shall be greater than the limiting deposit velocity for the size of material to be transported (see Appendix C-11) but shall not exceed 40 fps.	
Junctioning	Angle of confluence shall not exceed 5°45'.	Drains carrying less than 250 cubic yards of sediment may be allowed to junction with the mainline provided the total cumulative sediment is less than 1,000 cubic yards. The design concept must be approved by the Department prior to proceeding to final plans.
Inlet Design	Design the inlet to the concrete channel or conduit to accelerate flows into the drain. Provide a minimum slope of 2% for the invert slab.	

¹ If bends are unavoidable, the radius of curvature shall be at least 30 times the width of pipe. The central angle shall not exceed 45 degrees. The maximum deviation computed by the ratio: actual length from inlet to outlet/junction over straight line distance from inlet to outlet/junction, shall be less than 1.1.

² A drain slope of 3 to 5 percent may be permitted provided the velocity is greater than the limiting deposit velocity (V_1).