



April 1, 2021
Ms. Cathleen Goodwin
Water Resource Control Engineer
North Coast Regional Water Quality Control Board
5550 Skylane Blvd., Ste. A
Santa Rosa, CA 95403-1072

Submitted by email: Northcoast@waterboard.ca.gov; Cathleen.goodwin@waterboards.ca.gov;
Matthew.Herman@Waterboards.ca.gov

Subject: Report of Waste Discharge for NPDES Permit Reissuance (NPDES No. CA0022756) – City of Crescent City Wastewater Treatment Facility, Del Norte County

Dear Ms. Goodwin:

The City of Crescent City (City) offers the attached Report of Waste Discharge (ROWD) for reissuance of NPDES Permit No. CA0022756. The NPDES permit regulates operation of the Crescent City Wastewater Treatment Facility (WWTF) and discharge of treated effluent to the Pacific Ocean and disposal of biosolids. To complete the ROWD forms, the City used monitoring data submitted to the North Coast Regional Water Quality Control Board (Regional WaterBoard) starting on April 1, 2017 and ending on February 2021.

The ROWD package includes the following information:

- Section I - California Form 200
- Section II - USEPA Form 2A
- Section III - USEPA Form 2S
- Section IV – Service Area
- Section V – Wastewater Collection and Conveyance
- Section VI – Wastewater Treatment Processes
- Section VII - Treated Effluent Discharge
- Section VIII – Pretreatment Program
- Appendix A – Summary of April 2017 to February 2021
- Appendix B – Annual Reports 2017-2020
- Appendix C – Outfall Inspection Report
- Appendix D – Toxicity Reports 2016 to 2020
- Appendix E – Local Limits Report 2019
- Appendix F – Laboratory Results 2016- 2020
- Appendix G – Topographical Map
- Appendix H – Ocean Outfall Biological Survey 2021

Wastewater Treatment Facility Performance

Overall, the treatment plant performed well during the current permit term. Over the current permit term, the City completed a WWTF Capital Improvement Project for the construction of storm drain improvements. This project included construction of containment drains throughout the plant and expanded existing surface water system infrastructure that ties into the facility's headworks.

In addition to the WWTF capital improvement project. Over the current term, many other projects have been completed as part of ongoing maintenance and improvements. Significant projects include: installing a sodium bisulfite analyzer, replacing an RBC main shaft roller bearing, rebuilding an influent screen, rebuilding the ignition and pilot system for the waste gas flare, maintaining the belt filter press, replacing and repairing effluent re-use pumps, rebuilding automatic digester sludge feed valves, replacing a DO controller/probe mechanism on the MBR, replacing all composite samplers, rebuilding a sludge recirculation pump and replacing its gear box, rebuilding sludge pumps for clarifiers, repairing a filtrate carrier water pump, rebuilding and calibrating chemical pumps, establishing a lead/lag backup system used for chemical pumps, rebuilding both primary grit pumps, and replacing a Membrane Bioreactor (MBR) filtrate motor and air scour valve.

In 2019 the City solicited proposals from contract operations firms to operate and manage the Crescent City Wastewater Treatment Facility. Operations Management International, Inc (OMI), a member of the Jacobs Engineering Group took over responsibility for operations and maintenance on September 9, 2019. OMI's contract term is from September 9, 2019 through June 30, 2025.

Near-term projects for the WWTF include a CIP project for repaving asphalt surfaces and another CIP project to tie-in the MBR electrical system to standby power. Other future projects include rebuilding a second influent screen and headworks influent gate improvements, primary skimming system improvements, MBR membrane operating system improvements, and an assessment of the rotating biological contactors.

Collection System Performance

The City and County Service Area (CSA) maintain separate sanitary sewer collection systems within the service area. Flows generated within the CSA are collected and conveyed to the City's collection system. The City system then conveys combined City and County-generated flows to the wastewater treatment Facility (WWTF). During intense storm events Rain Dependent Inflow and Infiltration (RDII) can stress the collection system. The collection system is susceptible to RDII. In 2020, the City completed a Capital Improvement Project to replace the storm system and sewer line infrastructure on C street and a portion of Front Street. As another CIP project, The City contracted the installation of a collection system pump station SCADA system and all the pump station control center elements to improve control and monitoring of the collection system.

The City performs monthly preventative maintenance on known trouble spots throughout the collection system. The Sanitary Sewer Management Plan is currently under review.

Permit Compliance

During the current permit term, the plant experienced permit limit exceedances for fecal coliform, Fats oils and greases, Copper, and Total residual chlorine. Periodically, receiving water monitoring was accelerated when lab results came back with permit limit exceedances on

Enterococcus density. Typically, these exceedance results were during high seas and large storm events and returned to below limit values in follow up sampling results. The current WWTF permit limits influent flow rate daily average maximum to 6.12 MGD. During the permit reporting period, this limit was exceeded three times, in winter/spring 2019. The current discharge permit requires 85 percent removal of BOD and 85 percent removal of TSS. And the current discharge permit limits effluent BOD and TSS to less than 30 mg/L monthly average. These permit requirements were met throughout the permit term.

Pre-Treatment Program and Source Control Activities

There are three industrial users that discharge to the wastewater system and under discharge permits: A cheese factory and two breweries. These facilities are monitored and inspected on a regular basis.

In 2020 the city performed a survey identifying additional sites with interceptor devices which have been added to the Fats, Oils, and Grease (FOG) database. All businesses with interceptors are visited at least annually to verify they properly maintain interceptors. All visits are recorded in a database maintained by the Pretreat Coordinator.

In 2020, all active dental facilities discharging to the sewer system filled out the One-Time Compliance Report for Dental Discharges to comply with 40 CFR 441.50. Five of the six active dental facilities were found to be subject to the dental amalgam rule and have installed mercury amalgam separators. Details are in Section VIII.

Local Limits Evaluation

In 2018, a Local Limits Development Workplan for Crescent City Wastewater Treatment Plant was developed and approved by the state. In September 2019, a local limits evaluation was performed within the Crescent City sewer system based off of the approved workplan. Appendix E presents the Local Limits Report submitted to the state in 2020.

I am looking forward to working with you to complete the NPDES permit reissuance process. Please contact me at (707) 464-7483 or jolson@crestedcity.org if you have any questions regarding this permit application.

Sincerely,

Jonathon Olson, PE
Public Works Director
City of Crescent City

Attachment: Report of Waste Discharge for the City of Crescent City Wastewater Treatment Facility



Report of Waste Discharge



Section I - California Form 200



State of California
Regional Water Quality Control Board

APPLICATION/REPORT OF WASTE DISCHARGE
GENERAL INFORMATION FORM FOR
WASTE DISCHARGE REQUIREMENTS OR NPDES PERMIT

I. FACILITY INFORMATION

A. FACILITY:

Name
Address
City/County/State/Zip Code
Contact Person
Telephone Number Email

B. FACILITY OWNER:

Name
Address
City/State/Zip Code
Contact Person
Telephone Number Email
Federal Tax ID

Owner Type (Mark one):

Individual Corporation Governmental Agency Partnership

Other:

C. FACILITY OPERATOR (The agency or business, not the person):

Name
Address
City/State/Zip Code
Contact Person
Telephone Number Email

Operator Type (Mark one):

Individual Corporation Governmental Agency Partnership

Other:

D. OWNER OF THE LAND

Name _____

Address _____

City/State/Zip Code _____

Contact Person _____

Telephone Number _____ Email _____

Owner Type (*Mark one*):

Individual Corporation Governmental Agency Partnership

Other: _____

E. ADDRESS WHERE LEGAL NOTICE MAY BE SERVED

Address _____

City/State/Zip Code _____

Contact Person _____

Telephone Number _____ Email _____

F. BILLING ADDRESS

Address _____

City/State/Zip Code _____

Contact Person _____

Telephone Number _____ Email _____

II. TYPE OF DISCHARGE

Check Type of Discharge(s) Described in this Application:

Waste Discharge to Land

Waste Discharge to Surface Water

Check all that apply:

Animal or Aquacultural Wastewater

Land Treatment Unit

Animal Waste Solids

Landfill (*see instructions*)

Biosolids/Residual

Mining

Cooling Water

Storm Water

Domestic/ Municipal Wastewater
Treatment and Disposal

Surface Impoundment

Dredge Material Disposal

Waste Pile

Hazardous Waste (*see instructions*)

Wastewater Reclamation

Industrial Process Wastewater

Other, *please describe* _____

III. LOCATION OF THE FACILITY

Describe the physical location of the facility:

1. Assessor's Parcel Number(s)

Facility: _____

Discharge Point: _____

2. Latitude

Facility: _____

Discharge Point: _____

3. Longitude

Facility: _____

Discharge Point: _____

IV. REASON FOR FILING

Check all that apply:

New Discharge or Facility

Change in Design or Operation

Change in Quantity/Type of Discharge

Changes in Ownership/Operator (see instructions)

Waste Discharge Requirements Update or NPDES Permit Reissuance

Other: _____

V. CALIFORNIA ENVIRONMENTAL QUALITY ACT (CEQA)

Name of Lead Agency _____

Has a public agency determined that the proposed project is exempt from CEQA?

Yes No

If yes, state the basis for the exemption and the name of the agency supplying the exemption on the line below:

Has a "Notice of Determination" been filed under CEQA?

Yes No

If Yes, enclose a copy of the CEQA document, Environmental Impact Report (EIR), or Negative Declaration. If No, identify the expected type of CEQA document and expected date of completion.

Expected CEQA Documents: EIR Negative Declaration

Expected CEQA Completion Date: _____

VI. OTHER REQUIRED INFORMATION

Please provide a COMPLETE characterization of your discharge. A complete characterization includes, but is not limited to, design and actual flows, a list of constituents and the discharge concentration of each constituent, a list of other appropriate waste discharge characteristics, a description and schematic drawing of all treatment processes, a description of any Best Management Practices (BMPs) used, and a description of disposal methods.

Also include a site map showing the location of the facility and, if you are submitting this application for an NPDES permit, identify the surface water to which you propose to discharge. Please try to limit your maps to a scale of 1:24,000 (7.5' USGS Quadrangle) or a street map, if more appropriate.

VII. OTHER

Attach additional sheets to explain any responses which need clarification. List attachments with titles and dates below:

You will be notified by a representative of the RWQCB within 30 days of receipt of your application. The notice will state if your application is complete or if there is additional information you must submit to complete your Application/Report of Waste Discharge, pursuant to Division 7, Section 13260 of the California Water Code.

VIII. CERTIFICATION

"I certify under penalty of law that this document, including all attachments and supplemental information, were prepared under my direction and supervision in accordance with a system designed to assure that qualified personnel properly gathered and evaluated the information submitted. Based on my inquiry of the person or persons who manage the system, or those persons directly responsible for gathering the information, the information submitted is, to the best of my knowledge and belief, true, accurate, and complete. I am aware that there are significant penalties for submitting false information, including the possibility of fine and imprisonment."

Print Name _____ Title _____
Signature _____ Date _____

FOR OFFICE USE ONLY

Date Form 200 Received:	Letter to Discharger:	Fee Amount Received:	Check #:
-------------------------	-----------------------	----------------------	----------

Section IV: Service Area

As shown in Figure 1, Crescent City is located on the coast 15 miles south of the Oregon border in Del Norte County, California. The Service area of the CCWWTP is shown in Figure 2 and includes the city limits and the surrounding County Service Area (CSA). The CSA consists of two sub-areas: Northcrest area which is north of the city and Bertsch ocean view area to the east.

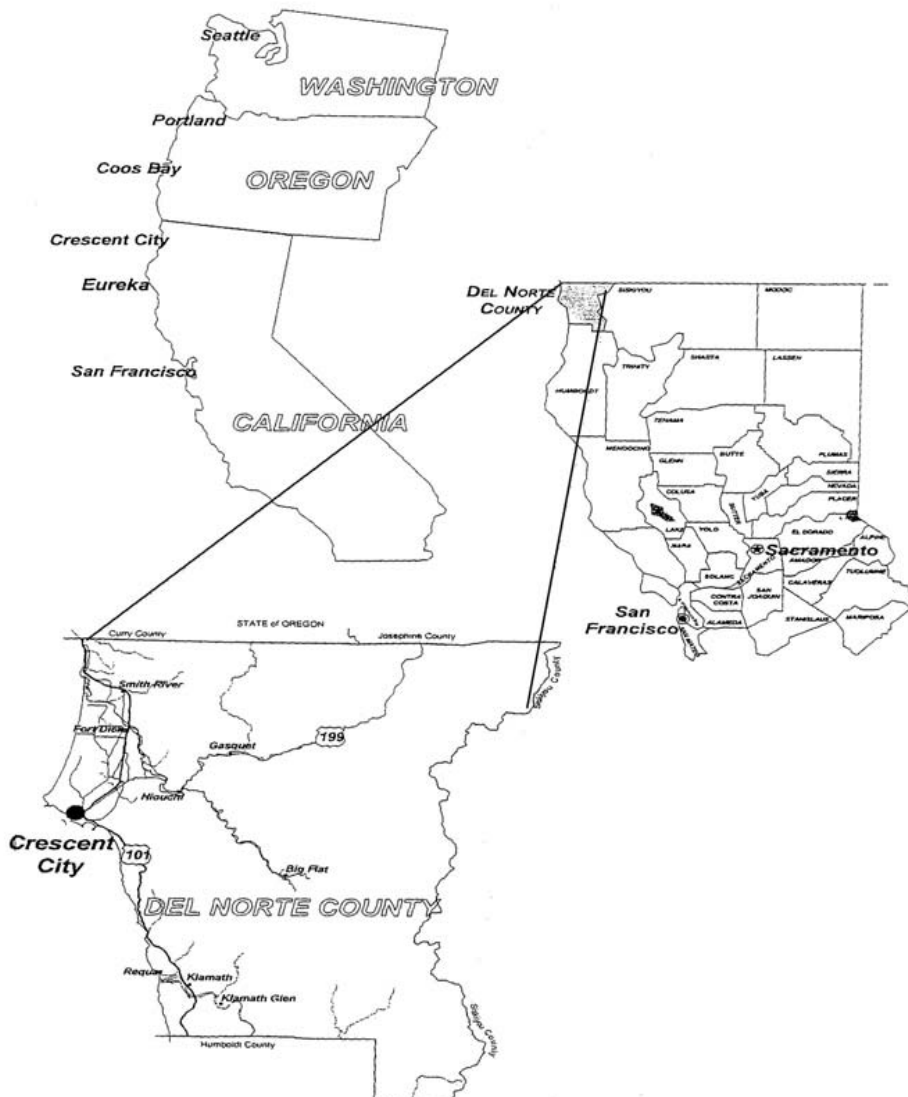

Figure 1: Crescent City Vicinity

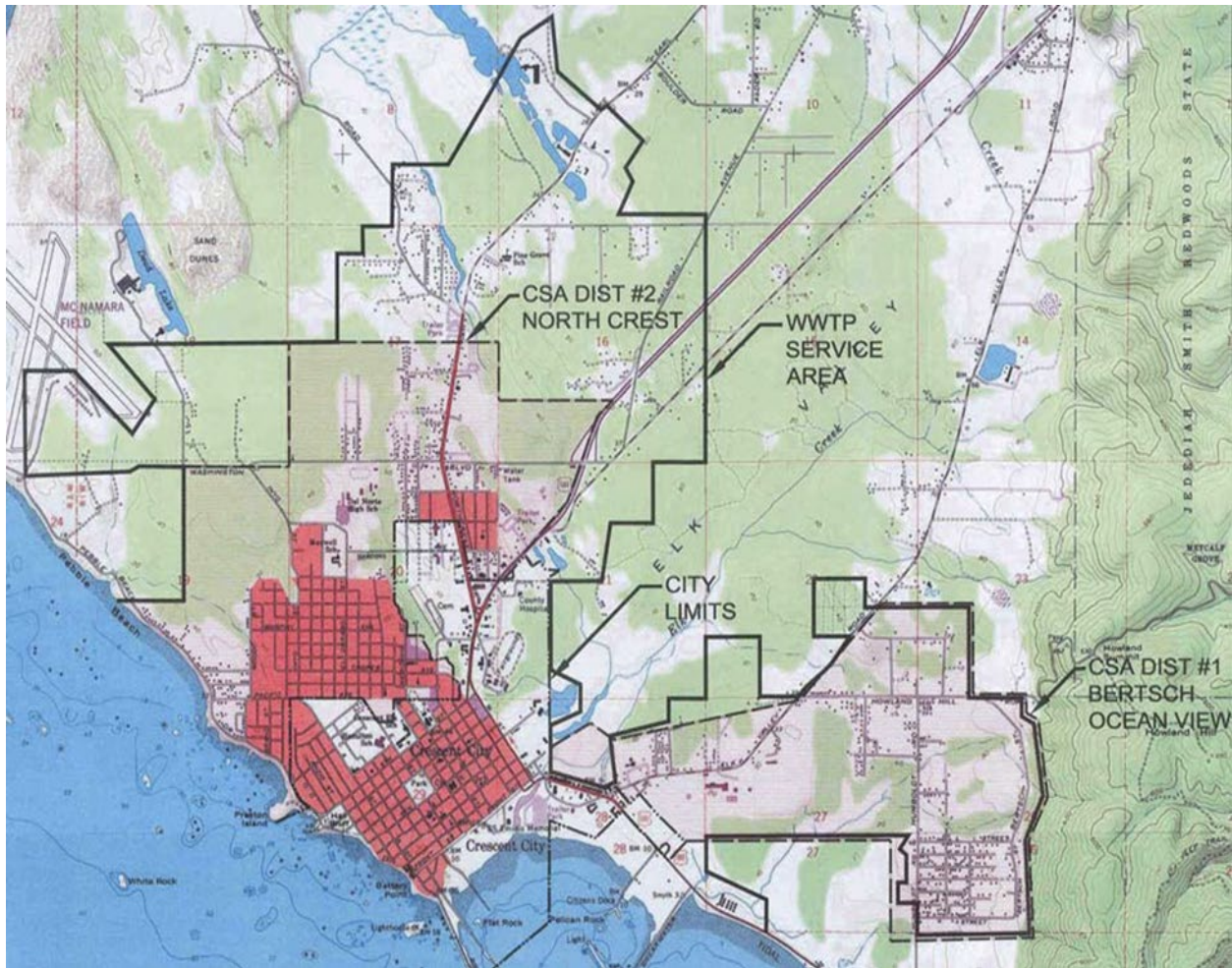

Figure 2: Crescent City and CSA Areas

4.1 Topography

The sewerage service area is on the Smith River Plain bordered by the Pacific Ocean to the west and the base of the Coast Mountain Range to the east. The topography within 2 miles of Crescent City is essentially flat and slopes gently south toward the harbor and east toward Elk Creek. The City has a maximum elevation change of 66 feet and an average elevation above sea level of 19 feet. The area within 2 miles of Crescent City is covered by herbaceous vegetation (35%), water (34%), and artificial surfaces (24%).

4.2 Geology and Soils

At a depth of 30 to 70 feet, the service area is underlain by the St. George Formation consisting of very low permeability consolidated coastal terrace deposits of sandstone and claystone. In the majority of the service area, the St. George Formation is overlain by the Battery Formation consisting of coastal terrace deposits of fine sand and clay with poor to moderate permeability. However, in the Harbor area east toward Elk Creek, the overlain soil consists of dune deposits of medium to coarse-grained sand of moderate to high permeability. Varying compositions of bedrock underlie these formations.

4.3 Climate

Crescent City has a temperate marine climate with temperatures typically ranging from 30 to 50 degrees Fahrenheit in the winter and 50 to 70 degrees Fahrenheit in the summer. Crescent city generally has dry, cool, foggy summers and wet, windy winters that rarely dip below freezing. The average yearly wind speed is 9 miles per hour (mph). During winter extreme storm events, prevailing winds reach 70 to 90 mph southeasterly; prevailing summer winds typically range from 10 to 40 mph north-northwesterly. The plant outfall discharges to the Pacific Ocean which has large waves that propagate into the outfall mixing zone. The average annual precipitation for Crescent City is summarized in Table 1. The maximum and minimum temperatures recorded in Crescent City are summarized in Table 2.

Table 1: Average Precipitation Data (1981-2010) in inches

Jan	Feb	Mar	Apr	May	Jun	Jul	Aug	Sep	Oct	Nov	Dec
10.82	8.92	9.11	6.34	3.54	2.01	0.35	0.57	1.19	4.51	10.18	13.7

Table 2: Average Temperature Data (1981-2010) in Degree Fahrenheit

Month	Jan	Feb	Mar	Apr	May	Jun	Jul	Aug	Sep	Oct	Nov	Dec
Average Max Temp	54	55	56	58	60	63	65	66	65	62	57	54
Average Min Temp	40	40	41	42	45	48	50	51	48	45	42	39

4.4 Population and Land Use

The 2003 Crescent City General Plan estimates the population change over the next 50 years, as shown in Table 3. As of 2019 the population within the Crescent City limits was estimated in 1996 to be 6,676 over 1.96 square miles. The population served by the sewer system County Service Area and the City service area was estimated in 1996 to be 15,573 people. Based off current sewer connection numbers it is estimated to be closer to 15,372 people.

Table 3: Population Estimates for Crescent City and CSA Service Area

Year (a)	Crescent City	CSA (b)	Septic (c)	Total
1996	4501	80243	0	12525
2003	5170	9217	0	14387
2007	5596	9977	0	15573
2027	8316	14825	400	27141
2057	15063	26853	4902	46818

Notes:

(a) Base population from 1996 Crescent City General Plan. See Note C for assumed County Service Area (CSA) population adjustment.

(b) CSA population based on the General Plan EIR (1996 pop. = 9,034) less 400 units on septic tanks at 2.524 persons each connection [9,034 – (400 x 2.524) =8,024].

(c) Estimated population now on septic tanks that will connect to public sewer by 2027 and 2057. The 2027 estimate is an approximation based on the 2057 value.

Section V: Wastewater Collection and Conveyance

5.1 Gravity Collection System

The City and County Service Area (CSA) maintain separate sanitary sewer collection systems within the service area. Flows generated within the CSA are collected and conveyed to the City's collection system. The City system then conveys combined City and County-generated flows to the wastewater treatment facility (WWTF). During intense storm events Rain Dependent Inflow and Infiltration (RDII) can stress the collection system. The collection system is susceptible to RDII. In 2020, the City completed a Capital Improvement Project to replace the storm system and sewer line infrastructure on C street and a portion of Front Street. As another CIP project, The City contracted the installation of a collection system pump station SCADA system and all the pump station control center elements to improve control and monitoring of the collection system. The City performs monthly preventative maintenance on known trouble spots throughout the collection system. the Sanitary Sewer Management Plan is currently under review.

During the last permit cycle (April 2017- December 2020) there were 3 rain events that led to Influent flow exceedances of over 6.12 MGD. On April 8th, 2019, the influent flow averaged 6.82 MGD, on February 12th 2019 the plant averaged 7.804 MGD, and on February 25th 2019 the plant averaged 7.917 MGD. In 2020, the City replaced sewer lines and storm drains on C street and the Southwest half of Front Street. In 2016 the City completed a sewer rehabilitation and replacement project on B Street. Figure 3 illustrates the City's collection basins and pipe network. Figures 4, 5, 6, and 7 show additional sewer maps for the collection system.

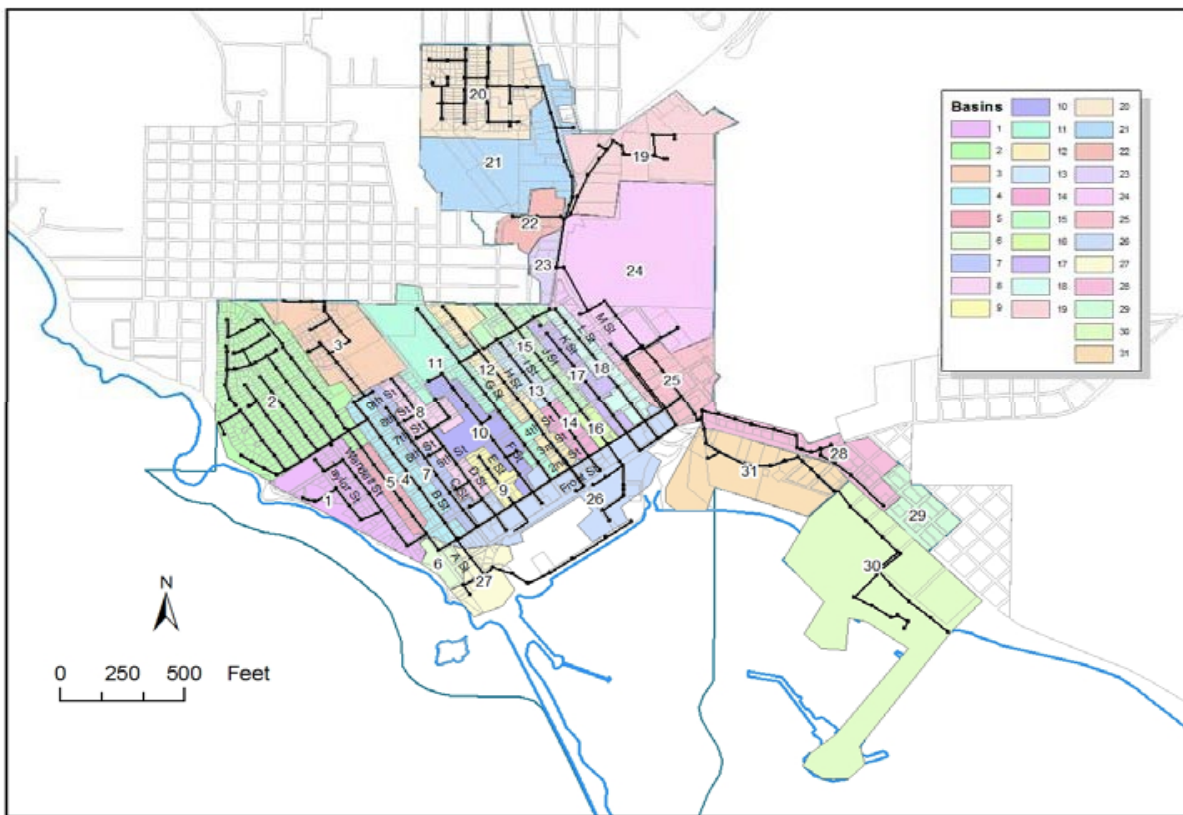

Figure 3: Crescent City Collection Basins and Pipe Network

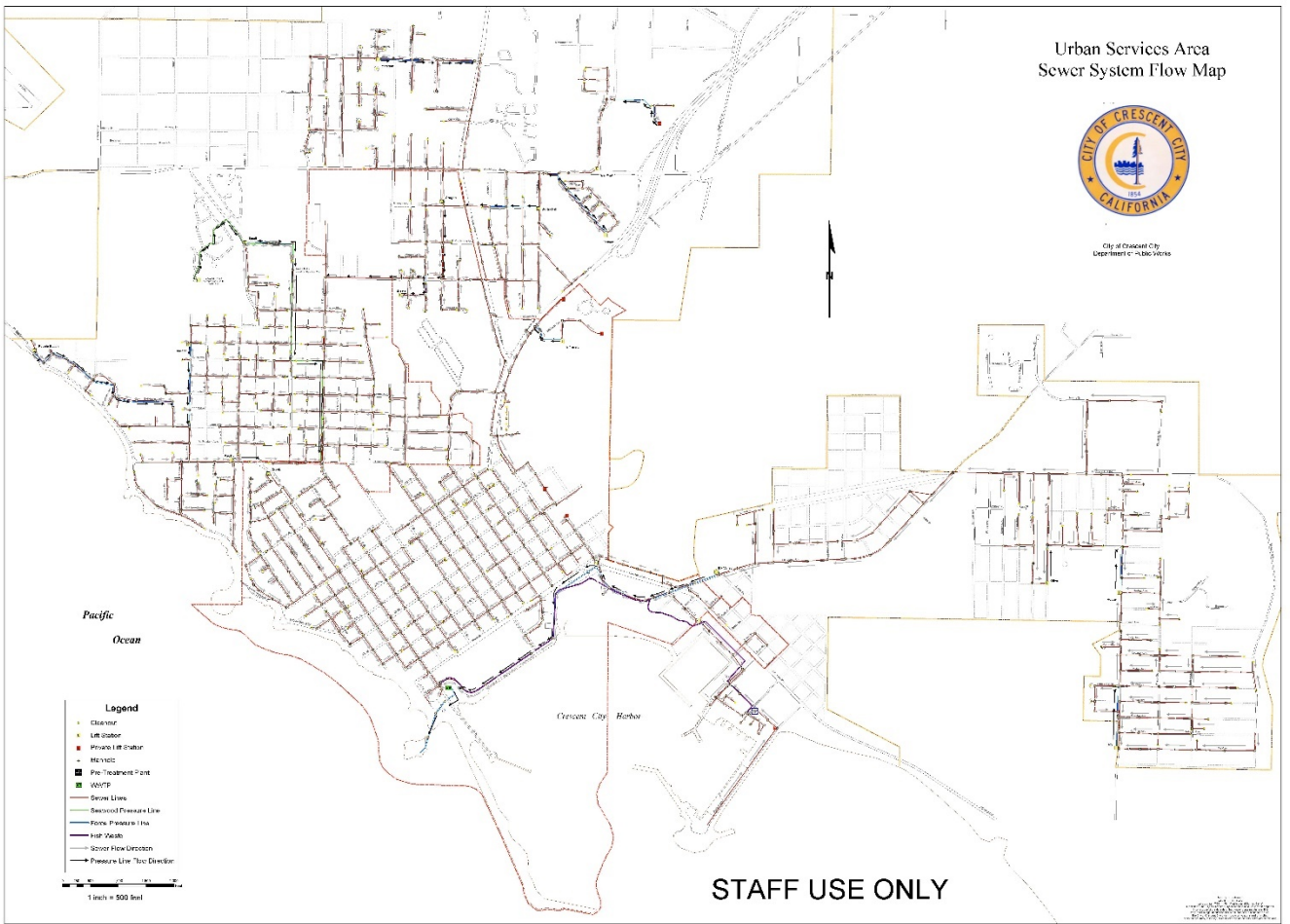

Figure 4: Crescent City and CSA Sewer System Flow Map



City of Aurora, Ill.
Water Department
1000 East Broadway Road, Aurora, IL 60009
1000 East Broadway Road, Aurora, IL 60009
1000 East Broadway Road, Aurora, IL 60009
1000 East Broadway Road, Aurora, IL 60009

Figure 5: Harbor Sewer Lines

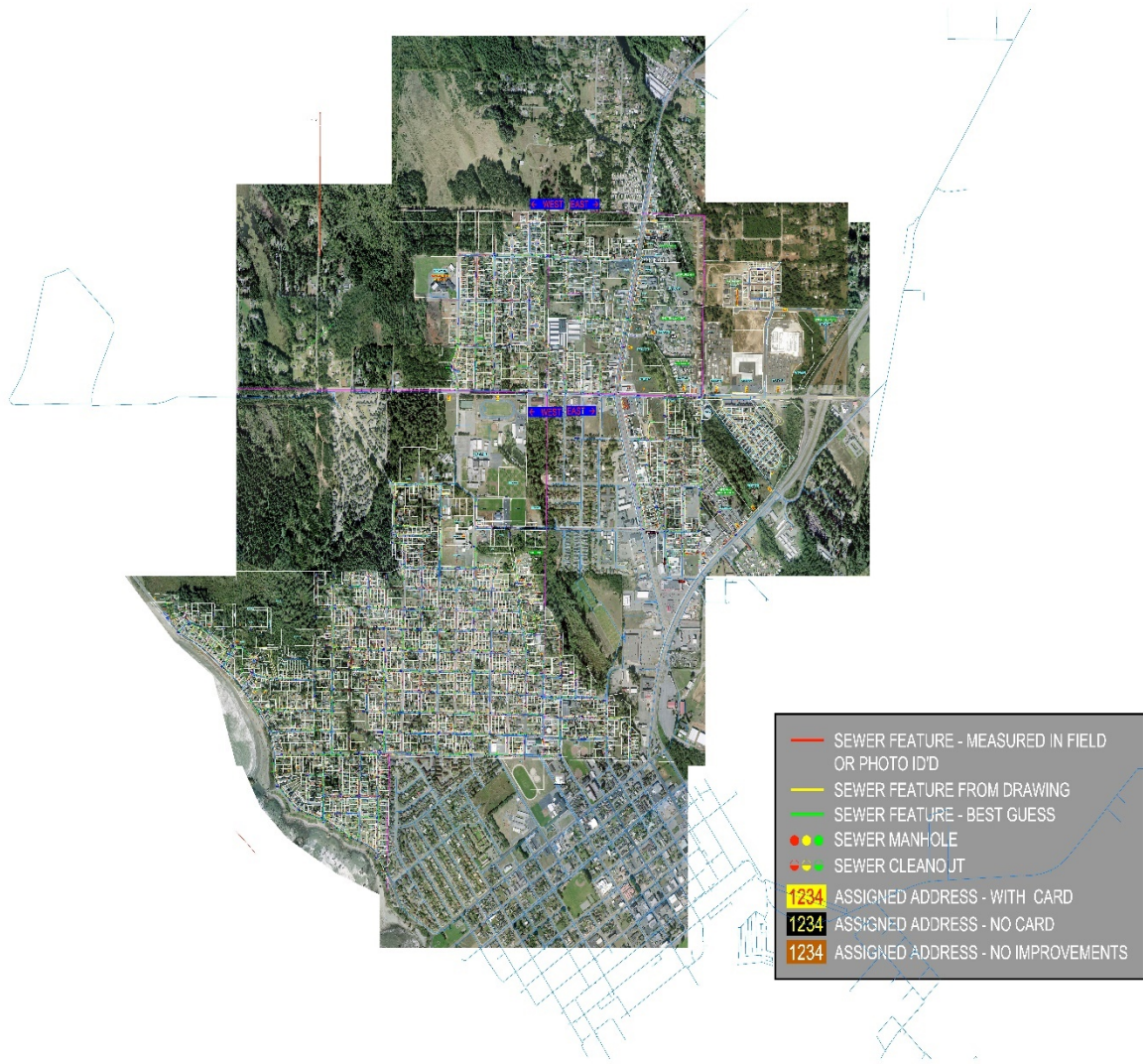

Figure 6: Northcrest CSA Sewer Map

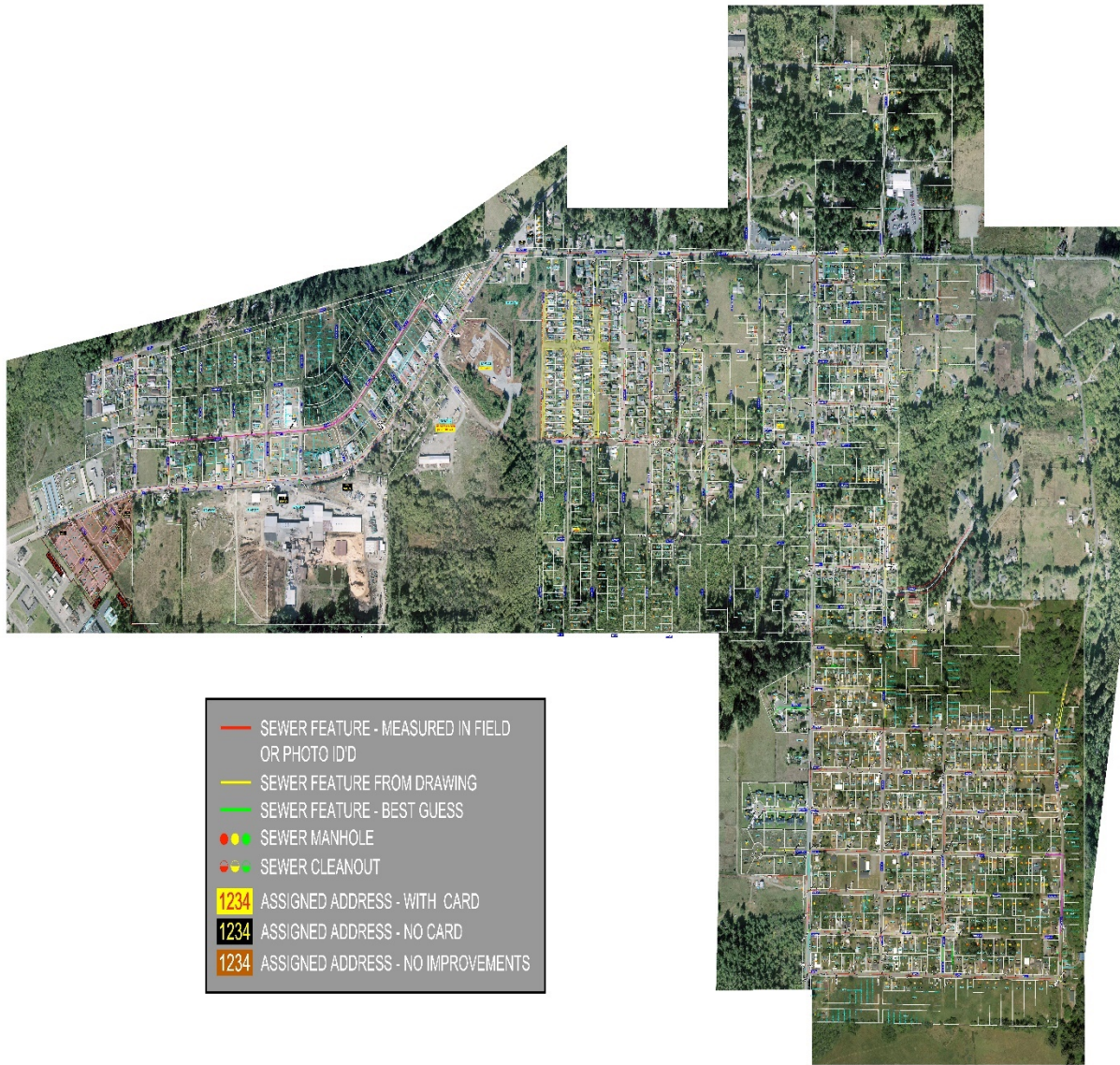

Figure 7: Bertsch Ocean View CSA Sewer Map

Section VI: Wastewater Treatment processes

The original treatment facility was constructed in the early 1950s and has since had many improvement projects most especially in 2010. This section addresses Influent Wastewater characteristics, treatment facilities, discharge permit requirements, and plant performance. Monthly Summary of Treatment Reports for April 2017 through February 2021 are included in Appendix A.

6.1 Wastewater Characteristics

Table 4 summarizes average (AVG), minimum (MIN), and maximum (MAX) Influent data for the period from April 2017 through February 2021. Influent flow in Million Gallons per Day (MGD), Biological Oxygen Demand (BOD) in milligrams per liter, and Total Suspended Solids (TSS) in milligrams per liter are presented. Table 5 summarizes the same information for Effluent.

Table 4: Crescent City Influent Wastewater Characteristics

Month	Flows, MGD			TSS, mg/L			BOD, mg/L		
	AVG	MIN	MAX	AVG	MIN	MAX	AVG	MIN	MAX
April 2017	2.907	2.183	3.988	121	75	205	108	64	156
May 2017	1.816	1.427	2.429	189	154	271	177	119	214
June 2017	1.364	1.186	1.657	212	170	263	233	196	270
July 2017	1.119	1.031	1.228	247	176	497	308	232	736
August 2017	1.057	0.997	1.112	264	217	333	309	261	397
September 2017	1.008	0.855	1.064	259	94	367	291	199	375
October 2017	1.001	0.948	1.143	284	190	449	297	213	600
November 2017	1.422	0.99	2.111	199	137	263	222	173	265
December 2017	1.348	1.154	1.78	191	153	246	215	168	252
January 2018	2.004	1.245	3.758	190	76	290	199	80	349
February 2018	1.613	1.398	2.072	171	143	228	184	104	217
March 2018	2.643	1.106	4.223	122	78	164	122	70	155
April 2018	1.932	1.488	2.371	125	88	158	132	93	186
May 2018	1.262	1.128	1.467	177	132	283	204	107	402
June 2018	1.092	1.045	1.165	233	153	283	265	213	302
July 2018	1.03	0.843	1	238	152	322	282	217	333
August 2018	0.978	0.918	1.12	229	186	265	283	237	330
September 2018	0.95	0.917	0.98	242	203	315	292	261	338
October 2018	0.96	0.9	1.05	234	180	262	302	251	407
November 2018	1	0.83	1.18	205	143	275	277	197	328
December 2018	1.273	1.044	2.02	202	134	339	240	169	383
January 2019	1.7	1.12	4.3	179	120	278	229	154	339

February 2019	2.955	1.577	7.917	142	91.8	237	136	87.1	196
March 2019	2.097	1.565	3.84	133	62	174	148	63	195
April 2019	2.41	0.97	6.82	146	35.6	241	139	62.7	210
May 2019	1.35	1.21	1.65	201	96.7	313	218	102	349
June 2019	1.12	1.05	1.22	257	164	456	314	209	617
July 2019	1.06	1	1.14	249	188	547	339.5	227	1090
August 2019	1	0.96	1.05	242	189	295	264	159	317
September 2019	1.01	0.95	1.15	308	226	408	297	256	363
October 2019	0.99	0.92	1.17	230	131	355	251	89.4	329
November 2019	0.93	0.87	1.08	308	217	537	309	248	443
December 2019	1.46	0.93	2.8	184	102	275	234	109	365
January 2020	2.44	1.5	3.7	135	84.3	240	152	91.7	268
February 2020	1.74	1.33	2.54	163	115	192	185	122	223
March 2020	1.25	1.15	1.4	225	200	329	248	218	296
April 2020	1.28	1.12	1.84	197	162	229	231	189	269
May 2020	1.28	1.09	1.57	189	152	215	207	155	250
June 2020	1.16	1.1	1.3	200	162	227	239	192	280
July 2020	1.08	1.03	1.12	250	196	406	284	232	437
August 2020	1.03	0.99	1.07	338	241	435	353	287	427
September 2020	0.97	0.91	1.01	363	222	501	362	272	500
October 2020	0.958	0.913	1.102	305.6	230	428	303.2	258	342
November 2020	1.04	0.905	1.394	309.15	149	393	297.18	258	342
December 2020	1.253	0.981	1.676	294	215	368	276	217	378
January 2021	2.22	1.51	3.86	180	75.2	296	174	99	263
February 2021	2.62	1.84	5.19	152	89	251	150	103	210
AVG	1.451	1.130	2.167	217.3	147.9	312.9	240.0	172.0	346.7
MIN	0.930	0.830	0.980	121.0	35.6	158.0	108.0	62.7	155.0
MAX	2.955	2.183	7.917	363.0	241.0	547.0	362.0	287.0	1090.0

Table 5: Crescent City Effluent Wastewater Characteristics

Month	Flows, MGD			TSS, mg/L			BOD, mg/L		
	AVG	MIN	MAX	AVG	MIN	MAX	AVG	MIN	MAX
April 2017	2.754	2.113	3.785	7	5.2	10.3	9.8	8.1	13.3
May 2017	1.813	1.501	2.313	6	4.4	9.8	7	5.7	8.8
June 2017	1.417	1.275	1.693	6.2	4.6	9.8	12.4	9.1	24
July 2017	1.041	0.662	1.385	6.5	4.7	8.7	12.6	8.5	18.9
August 2017	1.029	0.83	1.599	6.5	5.1	7.4	13.3	9.6	16.8

September 2017	0.88	0.822	1.046	7.6	6	10.2	13.2	10.2	20.6
October 2017	0.868	0.795	1.002	6	4.2	8.6	9	6.9	11.6
November 2017	1.222	0.852	1.793	7.4	5.6	11.1	15.1	10.6	20.8
December 2017	1.16	0.989	1.46	8.5	4.5	12.9	19.6	14.7	25.8
January 2018	1.697	1.065	3.068	9.2	6.2	13.5	17.7	11.7	24.7
February 2018	1.385	1.196	1.745	7.9	5.4	10	13.6	11	18.1
March 2018	2.371	1.711	3.729	8.5	6.6	10.9	18.1	11.7	58.6
April 2018	1.718	1.376	2.123	7.8	6.5	10	16.6	15.4	18.2
May 2018	1.141	0.997	1.311	7.8	6	10.6	14.7	8.8	20
June 2018	0.995	0.913	1.288	7.6	5.7	9.1	12.2	10.7	14.2
July 2018	0.904	0.843	1	7.5	6.7	9.4	14.0	10.6	23.6
August 2018	0.895	0.779	1.01	10	8.1	12.2	15.7	10.8	26.5
September 2018	0.871	0.793	0.95	8.9	6.2	12.8	11.5	7.6	15.9
October 2018	0.890	0.8	1.01	8.3	7	10.3	13.3	10.1	17.4
November 2018	0.930	0.8	1.18	10.1	7.2	12.7	19.9	14.7	25.5
December 2018	1.129	0.923	1.76	9.6	4.9	16.2	15.9	10	21.3
January 2019	1.410	0.900	3.75	7.3	4.7	9.5	14.6	10.3	17.7
February 2019	2.166	1.315	5.164	7.8	5.7	15.1	13.1	10.7	19.2
March 2019	1.181	0.729	2.36	7.7	6.9	9.4	15.2	11.2	17.7
April 2019	1.870	1.030	5.19	7.5	5.1	14.8	15.9	11.2	19.2
May 2019	1.103	0.976	1.363	6.0	4.8	9	18.0	15.0	20
June 2019	0.91	0.82	1.02	9.9	7.8	14.2	19.6	14.6	25.1
July 2019	0.82	0.690	1.02	9.72	7	16	17.1	13.9	19.4
August 2019	0.73	0.660	0.83	9.53	7.7	13.3	17.6	12.3	32.9
September 2019	0.730	0.650	0.880	7.8	6.2	9.4	13.2	7.8	16.6
October 2019	0.860	0.650	1.130	6.1	4.4	8	14.7	9.0	29.4
November 2019	0.920	0.850	1.1	5.8	3.7	13.5	15.2	12.2	20.53
December 2019	1.350	0.800	2.67	6.5	5.0	8	15.6	11.4	30.7
January 2020	2.280	1.400	3.7	8.54	5.6	13.6	18.6	12.6	30.3
February 2020	1.540	1.14	2.31	7.8	6.1	11.36	20.9	17.6	23.7
March 2020	1.050	0.9	1.24	8.8	6.3	15	19.1	14.2	26.4
April 2020	1.070	0.900	1.67	9.8	8.3	15.8	15.6	12.2	28.4
May 2020	1.07	0.890	1.38	8.8	5	12.2	14.1	12.1	17.4
June 2020	0.94	0.85	1.08	9.0	7.1	11.2	12.2	10	14.6
July 2020	0.83	0.700	0.92	9.8	6.7	14.1	14.5	9.8	22
August 2020	0.78	0.740	0.86	14.6	9.8	18.3	18.0	12.6	29.6

September 2020	0.780	0.710	0.860	11.8	9.4	15	15.1	11.2	31.4
October 2020	0.743	0.614	0.914	10.4	7.7	14.2	12.2	8.2	15.3
November 2020	0.769	0.613	1.16	9.7	7	15.4	10.0	7	12.5
December 2020	0.991	0.699	1.459	9.7	6.9	17.4	13.2	9.5	23.3
January 2021	1.890	1.310	3.86	16.5	9.5	26.8	18.2	13.4	23.7
February 2021	2.420	1.530	5.27	9.8	7.3	16	12.5	10.8	15.1
AVG	1.241	0.960	1.902	9	6	12	15	11	22
MIN	0.730	0.613	0.830	6	4	7	7	6	9
MAX	2.754	2.113	5.270	17	10	27	21	18	59

The current discharge permit recognizes the dilute sewage condition and requires 85 percent removal of BOD and 85 percent removal of TSS. These permit requirements were met throughout the permit period. Removal rates with the membrane bioreactor (MBR) process are summarized in Table 6.

Table 6: TSS and BOD Percent Removal

Month	TSS % removal	BOD % removal
April 2017	94.2	90.9
May 2017	96.8	96.01
June 2017	97.06	94.7
July 2017	97.4	95.9
August 2017	97.6	95.7
September 2017	97.1	95.5
October 2017	97.9	96.97
November 2017	96.3	93.2
December 2017	95.5	90.9
January 2018	95.2	91.1
February 2018	95.4	92.6
March 2018	93.0	85.2
April 2018	93.7	87.5
May 2018	95.6	92.8
June 2018	96.7	95.4
July 2018	96.9	95.0
August 2018	95.6	94.5
September 2018	96.3	96.1
October 2018	96.5	95.6
November 2018	95.1	92.8
December 2018	95.3	93.4

January 2019	95.9	93.6
February 2019	94.5	90.3
March 2019	94.2	89.8
April 2019	94.9	88.6
May 2019	96.8	91.9
June 2019	96.1	93.8
July 2019	96.1	95.0
August 2019	96.1	93.3
September 2019	97.5	95.6
October 2019	97.4	94.1
November 2019	98.1	95.1
December 2019	96.46	93.3
January 2020	93.7	87.8
February 2020	95.2	88.7
March 2020	96.1	92.3
April 2020	95.0	93.2
May 2020	95.4	93.2
June 2020	95.5	94.9
July 2020	96.1	94.9
August 2020	95.9	95.6
September 2020	96.8	95.8
October 2020	96.6	96.0
November 2020	96.9	96.6
December 2020	96.69	95.2
January 2021	90.83	89.55
February 2021	93.56	91.65
AVG	96	93
MIN	91	85
MAX	98	97

6.2 Receiving Water Beneficial Uses

The CCWWTP discharges to the Pacific Ocean in accordance with Order No. R1-2017-0002 under NPDES No. CA 0022756. This Order is issued pursuant to Section 402 of the Federal Clean Water Act (CWA) and implementing regulations adopted by the USEPA and Chapter 5.5, Division 7 of the California Water Code (commencing with Section 13370). It shall serve as an NPDES permit authorizing the CCWWTP to discharge into waters of the Pacific Ocean at Discharge Location 001. The Order also serves as Waste Discharge Requirements (WDRs) pursuant to Article 4, Chapter 4, Division 7 of the Water Code (commencing with Section 13260). The Outfall (Outfall-001) consists of a 24-inch ductile iron pipe that has an Effluent

conveyance capacity of 11 MGD to 13 MGD, depending on tide conditions. The outfall is sloped downward and discharges to a rocky slot in the surf zone adjacent to Battery point Lighthouse. The beneficial uses of the receiving stream (RSW-001) as established by the Water Quality Control Plan for the North Coast Region (Basin Plan) and California Ocean plan 2012 are listed as follows:

Existing:

- Navigation (NAV)
- Water Contact Recreation (REC-1)
- Non-Contact Water Recreation (REC-2)
- Commercial and Sport Fishing (COMM)
- Wildlife Habitat (WILD)
- Rare, Threatened or Endangered Species (RARE)
- Migration of Aquatic Organisms (MIGR)
- Spawning, Reproduction, and/or Early Development (SPAWN)
- Shellfish Harvesting (SHELL)
- Marine Habitat (MAR)
- Aquaculture (AQUA)
- Mariculture
- Industrial water supply
- Aesthetic enjoyment

Potential:

- Industrial Service Supply (IND)
- Industrial Process Supply (PRO)
- Area of Special Biological Significance (ASBS)

Treated wastewater may also be discharged to the recycled water system at Discharge Point 002. The plant does not currently discharge at this location but may in the future. The beneficial uses of the receiving stream (002) as established by the Water Quality Control Plan for the North Coast Region (Basin Plan) are listed as follows:

Existing:

- Municipal and domestic supply (MUN)
- Agriculture supply (AGR)
- Industrial service supply (IND)
- Native American Culture (CUL)

Potential:

- Industrial process supply (PRO)
- Aquaculture (AQUA)

6.3 Wastewater Treatment Improvements

Constructed in the 1950s, the original treatment plant facility consisted of a headworks, influent wetwell, pump house, “Clarigester” (solids separator), and gravity outfall. The first major plant upgrade occurred in 1973 which consisted of installing primary clarification capacity, converting the Clarigester to an anaerobic digester, and constructing new disinfection and solids handling facilities. The plant expanded again in 1979 to provide secondary treatment including additional raw wastewater pumps, rotating biological contactors, secondary clarifiers, new chlorine contact

basin and chlorination facilities, and a new digester. Since the 1979 plant expansion, additional improvements have included the following:

- Installation of a third secondary clarifier in 1983
- Replacement of the comminutor with a bar screen and construction of several
- lines to increase hydraulic capacity in 1991
- Installation of a new dewatering facility in 1993
- Addition of new chlorinators/sulfonators in 1996
- Addition of effluent pumps in 2002
- Replacement of chlorinators with sodium hypochlorite and bisulfite disinfection facilities in 2003
- Addition of a new MBR system and building housing MBR equipment and electrical
- equipment, a new Operations Building, a new Dewatering Building housing solids
- dewatering equipment, new equipment and rehabilitation of the headworks, primary
- clarifiers, solids thickening and digesters in 2010.
- Installation of a new influent screen in March 2014.
- Sewer rehabilitation on B street in 2016
- Facility Drainage Improvement in April 2020
- Sewer and storm drain improvements on Front Street and C Street in 2020
- Lift Station SCADA improvements 2020/2021

The 2010 upgrades included removing 36-inch and 48-inch storm drains that serve the surrounding area around the treatment plant site and re-routing them outside the plant boundaries. Figure 8 depicts the updated treatment plant layout, and Table 7 lists associated design data for the upgraded plant.

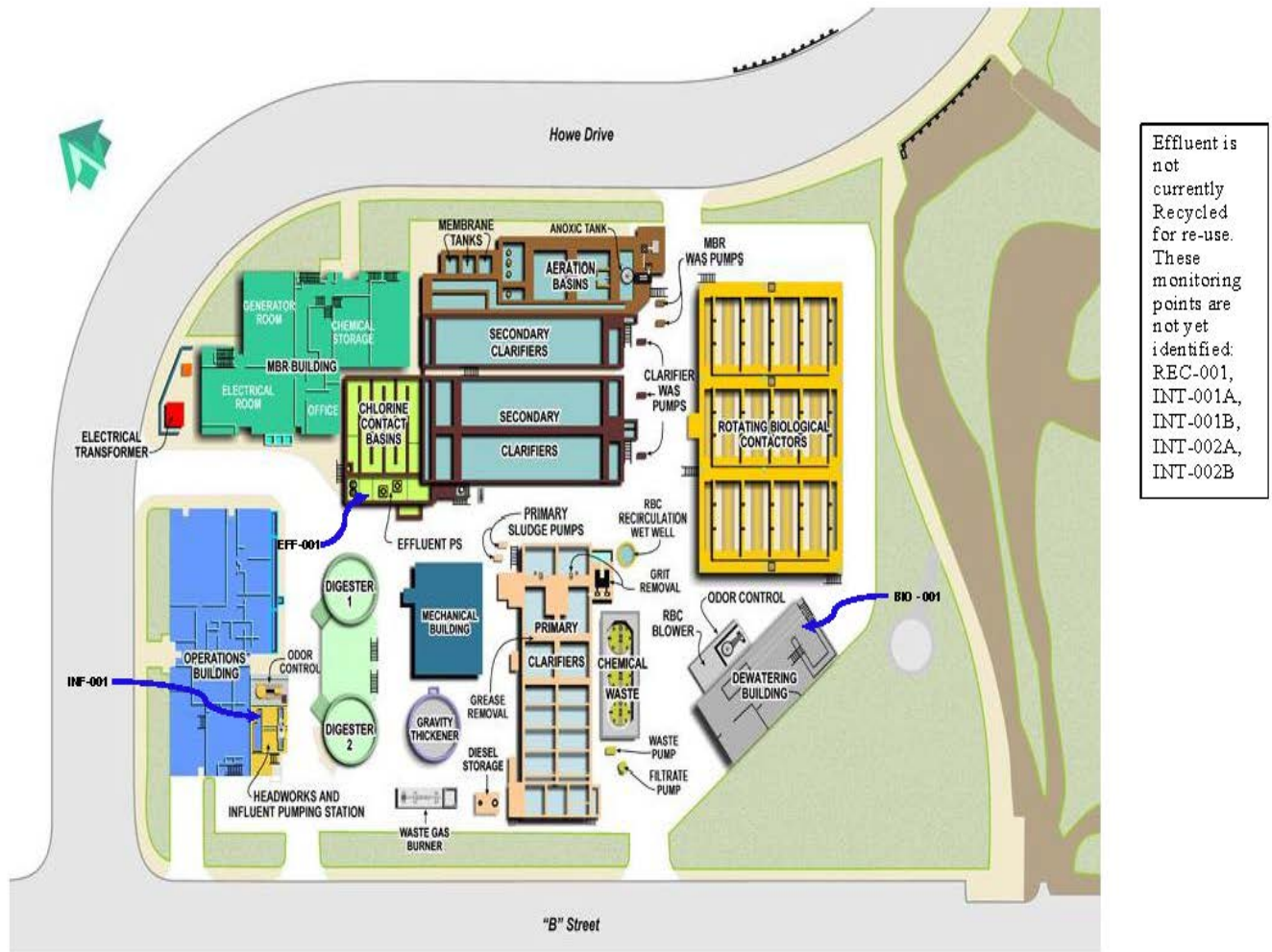

Figure 8: Wastewater Treatment Plant Map with Sampling Locations

Table 7: CCWWTP Design Data

Description	Design Data
Design Flow	
Average dry weather (ADWF), MGD	1.86
Maximum day dry weather, (MDDWF), MGD	2.5
Average wet weather (AWWF), MGD	1.8
Maximum month wet weather (MMWWF), MGD	2.7
Maximum week wet weather (MWWWF), MGD	3.2
Maximum day wet weather (MDWWF), MGD	5.0
Maximum hour wet weather (MHWWF), MGD	7.8
Design BOD Load	
Annual average, ppd(a)	1,440

Maximum month, ppd	2,400
Maximum week, ppd	2,650
Maximum day, ppd	3,570
Design TSS Load	
Annual average, ppd	2,420
Maximum month, ppd	3,500
Maximum week, ppd	4,490
Maximum day, ppd	4,730

Description	Design Data
--------------------	--------------------

Effluent Permit Limits

Ocean discharge

Monthly average BOD/TSS, mg/L	30/30
Monthly average BOD/TSS, lbs/day	465/465
Weekly average BOD/TSS, mg/L	45/45
Weekly average BOD/TSS, lbs/day	700/700

Effluent reuse(b)

Maximum daily flow, MGD	1.2
-------------------------	-----

Disinfection requirements

Total Coliform	2.2 MPN(c)/100 ml(d)
Monthly average BOD/ TSS, mg/L	10/10
Weekly average BOD/ TSS, mg/L	15/15
Monthly average Settleable solids, ml/L	0.1

Influent Pumping Station

Number of pumps at capacity each, MGD	1 @ 1.50, 1 @ 2.43 1 @ 3.89, 2 @ 5.23
Firm pumping station capacity(e), MGD	13

Coarse Screening

Number	2
Capacity, MGD, each	5.6

Grit Removal

Number	2
Capacity, MGD, each	3.9

Primary Clarification

Number	2
Length, ft(f)	75
Width, ft	16
Depth, ft	9.3
Maximum day flow capacity each (at 3,000 gpd/sf(g)), MGD	3.6

Fine Screening (Prior to MBR Treatment)

Type: fine, 2 mm(h) opening

Number	1
Capacity, MGD, each	2.4

Rotating Bio-Contactors

Number of units	3
Stages per unit	4
Media diameter, ft	11.8
Surface area/stage, sq ft(i)	
1st stage	110,000 to 130,000
2nd, 3rd, 4th stage	100,000
Surface loading rate, avg gpd/sf	1.4
Surface loading rate, peak gpd/sf	4.5

Secondary Clarification

Number of units	3
Volume each, gallons	129,000
Area, each, sq ft	1,680

Membrane Bioreactors

Typical operating flow, MGD	0.3 – 0.6
Continuous rated flow capacity, MGD	1.2
Maximum day flow capacity, MGD	1.5
Maximum hour flow capacity, MGD	1.9

Description**Design Data****Disinfection****Type of effluent disinfection**

Ocean discharge	Chlorine
Reuse applications	UV-lpho(i)

Effluent Reuse Pumping Station(b)

Number of pumps at capacity, each, MGD	2 @ 0.8
--	---------

Effluent Pumping Station

Number of pumps at capacity, each, MGD	2 @ 4.0
--	---------

Effluent Outfalls**Outfall 1**

Diameter: 12 and 18 inches	
Approximate capacity, MGD	
Gravity flow	2
Pumped flow	7 to 8

Outfall 2

Diameter: 24 inches	
Approximate capacity, gravity flow, MGD	11-13

Sludge Thickening

Type: Primary sludge gravity thickener

Surface area, sq ft 314

Solids loading, lb/sq ft -day(k) 20

Type: WAS rotary drum thickener

Number of units 1

WAS solids concentration, mg/L 3,000

Capacity, gpm(l), each 170

Sludge Digestion

Type: Anaerobic digestion

Number 2

Diameter, ft 24

Sidewater depth, ft 25

Biosolids Dewatering

Type: Belt filter press

Belt width, m(m) 1.5

Dewatered Biosolids Production

Monthly dewatering biosolids volume, cubic ft/month 3,200

Notes:

(a) ppd = pounds per day.

(b) effluent reuse system is not in service and will not be placed into service without Board approval.

(c) mpn = most probable number.

(d) ml = milliliters.

(e) Firm station capacity: capacity of pump station with largest unit out of service.

(f) ft = feet.

(g) gpd/sf = gallons per day per square foot.

(h) mm = millimeters.

(i) sq ft = square feet.

(j) UV-lpho – Ultraviolet-low pressure high output.

(k) lb/sq ft -day = pounds per square foot per day.

(l) gpm = gallons per minute.

(m) m = meters.

6.3.1 Liquid Stream

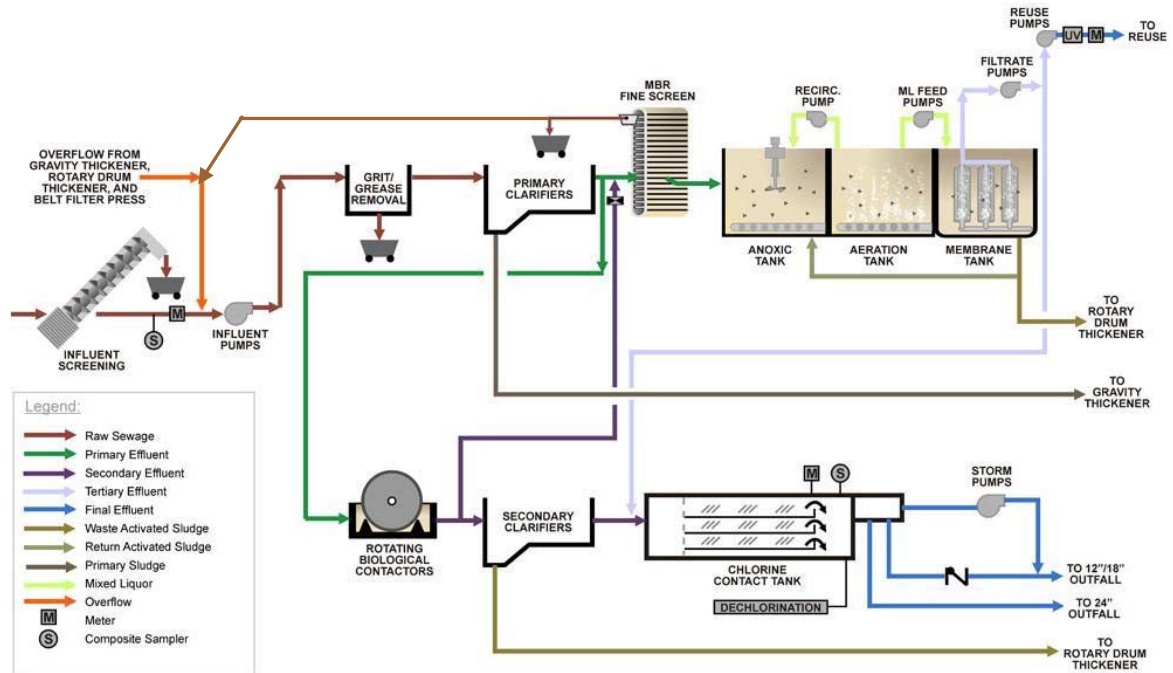

Figure 9: CCWWTP Liquid Stream Schematic

Figure 9 illustrates the liquid stream treatment schematic. Raw wastewater is conveyed to the plant through a 21-inch-diameter gravity line to the headworks structure. The headworks include mechanically cleaned screens, a flow measuring Parshall flume, and a wetwell in which five pumps are available to lift the flow to the primary clarifiers. Pumping capacity is 18.3 MGD with all five pumps operating, and approximately 13 MGD with the largest pump out of service.

Primary treatment consists of two grit removal tanks followed by two rectangular primary clarifiers. Primary sludge is pumped to the gravity thickener. Floatable scum and grease is mechanically skimmed and pumped to the gravity thickener.

Secondary treatment is provided by operating the rotating biological contactors (RBC) and MBR in parallel. The RBC system consists of three trains of four-stage, RBCs with a combined surface area of 1.2 million square feet. Flow from the RBCs reach three rectangular secondary clarifiers where the biological solids settle. The solids are drawn to hoppers at the inlet end of the tanks, where they are removed and pumped to the gravity thickener with an option to be pumped to the rotary drum thickener.

MBR treatment utilizes a similar population of bacteria and identical biochemical pathways to those found in other aerated biological processes to convert soluble and particulate BOD. Bacteria are concentrated and supplied with oxygen in the aeration basin. The bacteria consume BOD and convert it to carbon dioxide and water as they metabolize and reproduce.

6.3.2 Solids Stream

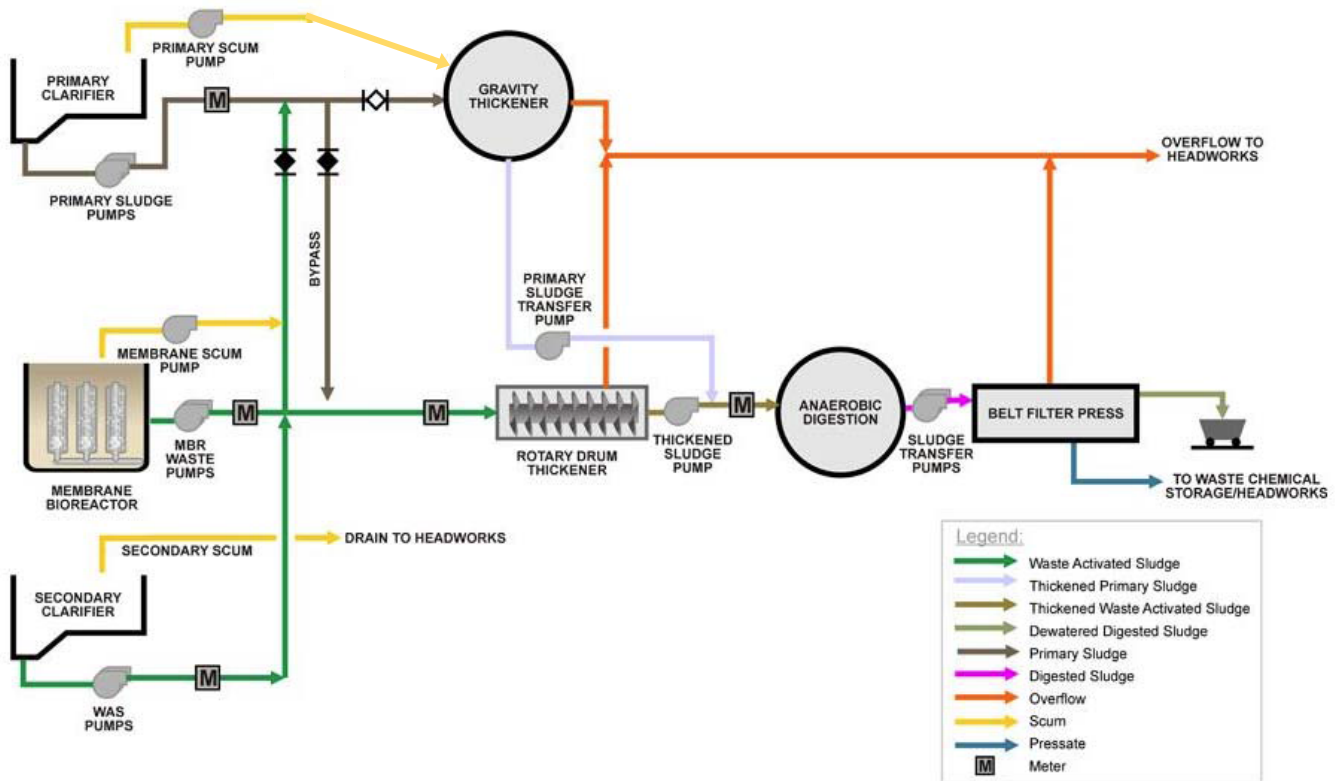

Figure 10: CCWWTP Solid Stream Schematic

Figure 10 illustrates the plant solids handling schematic. Solids handling consists of gravity thickening primary sludge, rotary drum thickening of MBR and secondary sludge, and anaerobic digestion of thickened solids. One of two digesters is heated and mixed. Digested Sludge is transferred from the heated digester and held in a second digester until pumped to the belt filter press. Digested solids are dewatered using a belt filter press and hauled to the Dry Creek landfill near Medford, Oregon.

Section VII: Treated Effluent Discharge

7.1 Ocean Outfalls



Figure 11: Receiving Water Monitoring Location and approximate location of Outfall-001

The plant has two ocean outfall lines that are interconnected at the discharge location (RSW-001). The older outfall includes an 18-inch-diameter pipeline from the Crescent City WWTP to the shoreline (approximately 600 feet) and a 12-inch-diameter pipeline that runs from the shoreline at Battery Point, across a tidal sand bridge, then along the southern shoreline of Lighthouse Island. The 18-inch-diameter pipeline was installed in the 1980s. The 12-inch-diameter pipeline is roughly 50 years old. In the early 1970s, the end of the outfall was modified with the addition of a 20-inch-diameter pipe. The pipe is sloped downward at a 45-degree angle and discharges into the bottom of a natural slot formed in the basalt, a 10-foot-deep surge channel on the south side of Lighthouse Island. The slot faces the direction of prevailing wave impact, which provides for intense wave activity that promotes dilution of effluent into the

receiving waters. The older outfall has an approximate gravity capacity of 2 MGD and a capacity of 7 MGD when both effluent pumps are operating.

A second 24-inch-diameter pipeline was constructed in 2005 to significantly increase effluent conveyance capacity. The newer outfall has a gravity flow capacity of 11 to 13 MGD depending on tide conditions.

7.2 Effluent Quality and Receiving Water monitoring

Treatment plant performance during the reporting period (April 2017 to December 2020) has been generally satisfactory. The plant has experienced periodic effluent violations with fecal coliform, Fats oils and greases, Copper, and Total residual chlorine.

Periodic issues also exist with receiving water monitoring for enterococcus, but usually correspond with large storm events. An Outfall inspection was performed in 2019 and submitted in 2020 and attached in Appendix C. The Crescent City Ocean Outfall Biological Survey Report was completed in 2021 and is attached in Appendix H. Appendix A includes monthly Summary of Treatments for the reporting period, and Appendix B contains the Annual reports for the CCWWTP.

In August 2017, the CCWWTP performed their 3- species sensitivity screening and it was found that *Atherinops Affinis* (topsmelt) had the highest Percent Effect of the three species. All subsequent Chronic toxicity tests during the permit term passed and are presented in Appendix D.

Section VIII: Pretreatment Program

This section presents a summary of Pretreatment Program Management from 2017 to 2020.

8.1 Industrial Wastewater

There are three industrial users attached to the wastewater system, all are under discharge permits.

8.2 Fats, Oils, and Grease (FOG)

In 2020 the city performed a survey identifying additional sites with interceptor devices which have been added to the FOG database. All businesses with FOG interceptors are visited at least annually to verify they have been properly maintaining their interceptor. All visits are recorded in a FOG database maintained by the Pretreat Coordinator.

8.3 Dental Discharges

In 2020, all active dental facilities discharging to the sewer system filled out the One-Time Compliance Report for Dental Discharges to comply with 40 CFR 441.50. Five of the six active dental facilities were found to be subject to the dental amalgam rule and have installed mercury amalgam separators.

8.4 Commercial Discharger Files and Database

The Pretreat Coordinator maintains a database with information on each commercial sewer user. The database stores all of the information regarding the facilities including contacts, itemized discharges, pretreatment devices, and condition notes from inspections.

8.5 Industrial Discharge Permit Activities and Enforcement Actions

There are three Significant (non-categorical) Industrial Users (SIU) with discharge permits within the Crescent City and CSA sewer system. The largest Industrial user is Rumiano Cheese

Company with a flow between 20,000 and 75,000 gallons per day to the CCWWTP. Rumiano is inspected semi-annually, sampled monthly for BOD, TSS, pH, SS, and sampled annually for FOG and ammonia. Rumiano has continued to remain in compliance with their permit limits throughout the permit cycle.

Also there are two breweries, Seaquake and Port O Pints, within the jurisdiction of the CCWWTP who are inspected and sampled semiannually for BOD, TSS, pH, FOG, and ammonia. Port O pints has had a couple of Notice of Violations (NOV) issued for BOD and TSS throughout the permit period. Seaquake has had numerous permit violations and NOV's issued throughout the permit period for TSS, BOD, FOG, and pH. In 2020, Seaquake was published in the Newspaper for Significant Non-Compliance. Seaquake has since had their permit limits increased to 50 lbs/ day for TSS and 250 lbs/ day for BOD due to increased production at the facility.

In 2018, all permittees had their discharge limits converted from a daily concentration to mass-based loading. Additionally, all permittees had their permits updated in 2020 as required by the state after the Pretreatment Audit.

As of 2014, Alber's Seafood was no longer considered an SIU and was placed under standard city industrial rates. Their discharges are limited to seasonal bottom fishing and only required drain screening and corrosion resistant pumps at the lift station. On November 20th, 2017, debris from Alber's caused the shutdown of the lift station and a Sanitary Sewer Overflow (SSO).

8.6 Local Limits Evaluation

In 2018, a Local Limits Development Workplan for Crescent City Wastewater Treatment Plant was developed and approved by the state. In September 2019, a local limits evaluation was performed within the Crescent City sewer system based off of the approved workplan. Appendix E presents the Local Limits Report submitted to the state in 2020.

Appendix A:

Summary of Treatment April 2017 -February 2021

CITY OF CRESCENT CITY WPCF - SUMMARY OF TREATMENT REPORT

DISCHARGE MONITORING - PERMIT No. CA0022756
 ORDER # R1-2011-0019 ID # 1A84006ODN

CITY OF CRESCENT CITY WPCF - SUMMARY OF TREATMENT REPORT

DISCHARGE MONITORING - PERMIT No. CA0022756
 ORDER # R1-2011-0019 ID # 1A84006ODN

APR 2017

ALL SAMPLES ARE FROM MONITORING LOCATION EFF-001 WITH
 EXCEPTION OF THE THREE IN BOLD MARKED INF

Page 1 APR 2017

ALL SAMPLES ARE FROM MONITORING LOCATION EFF-001 WITH EXCEPTION OF THE
 THREE IN BOLD MARKED INF

Page 2

DAY	DAILY REQUIREMENTS						WEEKLY REQUIREMENTS						DAY	RAIN IN	FLOW MGD	INF TOTAL AMMONIA mg/L	ONE SAMPLE PER MONTH REQUIRED					GREASE & OIL mg/L		
	RAIN IN	INF FLOW MGD	FLOW MGD	pH	TOTAL CL ₂ mg/L	SETTLE SOLIDS EFF	SUSPENDED SOLIDS			BOD 5							FECAL MPN	TURB NTU	TOTAL AMMONIA mg/L	TOTAL COPPER mg/L	TOTAL COPPER ug/L		TOTAL NICKEL mg/L	TOTAL NICKEL ug/L
1	0.00	2.618	2.508	7.2	<0.05	<0.1								3.5	1	0.00	2.508							
2	0.00	2.490	2.360	7.2	<0.05	<0.1	132	6.1	120	129	8.2	161		3.4	2	0.00	2.360	11.8	5.1					
3	0.00	2.357	2.294	7.2	<0.05	<0.1							4	4.4	3	0.00	2.294							
4	0.00	2.264	2.174	7.2	<0.05	<0.1	144	5.4	98	151	8.1	147		3.5	4	0.00	2.174	12.6	5.9					
5	0.15	2.183	2.113	7.2	<0.05	<0.1							<1.8	3.9	5	0.15	2.113							
6	0.97	2.310	2.272	7.3	<0.05	<0.1								4.4	6	0.97	2.272							
7	0.62	2.403	2.330	7.3	<0.05	<0.1								5.5	7	0.62	2.330							
8	0.10	2.706	2.605	7.2	<0.05	<0.1	153	8.0	174	132	11.1	241	<1.8	3.7	8	0.10	2.605							
9	0.91	2.646	2.515	7.2	<0.05	<0.1	92.9	6.6	138	118	9.4	197		3.3	9	0.91	2.515	8.6	3.7					
10	0.25	2.859	2.728	7.2	<0.05	<0.1							17	4.7	10	0.25	2.728							
11	0.32	2.788	2.638	7.2	<0.05	<0.1	121	5.6	123	97.6	8.4	185		4.2	11	0.32	2.638	8.8	3.9	0.010	10.0	0.015	15.0	<5.0
12	0.86	3.024	2.885	7.3	<0.05	<0.1							2	4.3	12	0.86	2.885							
13	0.35	3.197	3.066	7.3	<0.05	<0.1	120	7.1	182	97.9	10.6	271		4.1	13	0.35	3.066							
14	0.07	3.006	2.845	7.2	<0.05	<0.1								4.1	14	0.07	2.845							
15	0.00	2.752	2.599	7.2	<0.05	<0.1							2.0	3.4	15	0.00	2.599							
16	0.34	2.607	2.484	7.2	<0.05	<0.1	205	5.2	108	156	8.4	174		3.2	16	0.34	2.484	8.7	3.5					
17	1.00	2.761	2.635	7.3	<0.05	<0.1							4.5	4.6	17	1.00	2.635							
18	0.03	2.944	2.731	7.2	<0.05	<0.1	116	6.3	143	116	10.6	241		4.7	18	0.03	2.731	9.0	3.7					
19	2.88	3.739	3.307	7.3	<0.05	<0.1							4.5	4.2	19	0.00	3.307							
20	0.02	3.988	3.638	7.2	<0.05	<0.1	110	10.3	313	90.3	13.3	404		4.4	20	0.02	3.638							
21	0.21	3.291	3.097	7.2	<0.05	<0.1								3.8	21	0.21	3.097							
22	0.09	3.008	2.946	7.3	<0.05	<0.1							4	4.4	22	0.09	2.946							
23	1.02	2.869	2.697	7.3	<0.05	<0.1	82.7	5.6	126	71.7	9.6	216		3.4	23	1.02	2.697	7.6	3.0					
24	0.31	3.461	3.346	7.2	<0.05	<0.1							240	4.5	24	0.31	3.346							
25	0.86	3.255	3.129	7.2	<0.05	<0.1	94.8	9.5	248	70.0	11.1	290		3.2	25	0.86	3.129							
26	0.37	3.982	3.785	7.2	<0.05	<0.1							22	4.2	26	0.37	3.785							
27	0.00	3.412	3.148	7.3	<0.05	<0.1	75.2	8.2	215	63.7	9.2	242		4.0	27	0.00	3.148	5.6	2.4					
28	0.00	2.975	2.815	7.2	<0.05	<0.1								3.2	28	0.00	2.815							
29	0.00	2.730	2.525	7.2	<0.05	<0.1								3.0	29	0.00	2.525							
30	0.00	2.589	2.412	7.2	<0.05	<0.1								2.7	30	0.00	2.412							
TOTAL	11.73	87.21	82.63											TOTAL	8.85	82.63								

(MEDIAN)

AVG	0.39	2.907	2.754	7.2	<0.05	<0.1	121	7.0	166	108	9.8	231	4.5	3.9	AVG	0.30	2.754	9.1	3.9	0.010	10.0	0.015	15.0	<5.0
MIN	0.00	2.183	2.113	7.2	<0.05	<0.1	75	5.2	98	64	8.1	147	2	2.7	MIN	0.00	2.113	5.6	2.4	0.010	10.0	0.015	15.0	<5.0
MAX	2.88	3.988	3.785	7.3	<0.05	<0.1	205	10.3	313	156	13.3	404	240	5.5	MAX	1.02	3.785	12.6	5.9	0.010	10.0	0.015	15.0	<5.0

DISCHARGE LIMITS:

INSTANT MAX.	1.8	3												225
DAILY MAX.	0.24	0.2												
7 DAY AVG.							45	700		45				100
30 DAY AVG.							0.1	30	465	30				75
DAILY MAX. OF 10% pH			6.0/9.0											43
SIX MONTH MEDIAN				0.06										

ND = NON DETECTED **NA = NOT ANALYZED**

ANALYTE	METHOD USED	METHOD USED	PQL
TOTAL COPPER	EPA 200.7	EPA 200.7	0.020
TOTAL ZINC	EPA 200.7	EPA 200.7	0.050
GREASE & OIL	EPA 1664	EPA 1664	5.0
CHLOROFORM	EPA 624	EPA 624	0.50

42.31 TOTAL RAINFALL (year-to-date)

CALCULATED % REMOVALS
 TSS **94.20** BOD **90.88**

CITY OF CRESCENT CITY WPCF - SUMMARY OF TREATMENT REPORT

DISCHARGE MONITORING - PERMIT No. CA0022756
 ORDER # R1-2011-0019 ID # 1A84006ODN

CITY OF CRESCENT CITY WPCF - SUMMARY OF TREATMENT REPORT

DISCHARGE MONITORING - PERMIT No. CA0022756
 ORDER # R1-2011-0019 ID # 1A84006ODN

MAY 2017

ALL SAMPLES ARE FROM MONITORING LOCATION EFF-001 WITH
 EXCEPTION OF THE THREE IN BOLD MARKED INF

Page 1 MAY 2017

ALL SAMPLES ARE FROM MONITORING LOCATION EFF-001 WITH EXCEPTION OF THE
 THREE IN BOLD MARKED INF

Page 2

DAY	DAILY REQUIREMENTS						WEEKLY REQUIREMENTS								DAY	RAIN IN	FLOW MGD	INF TOTAL AMMONIA mg/L	ONE SAMPLE PER MONTH REQUIRED					GREASE & OIL mg/L
	RAIN IN	INF FLOW MGD	FLOW MGD	pH	TOTAL CL ₂ mg/L	SETTLE SOLIDS EFF	INF mg/L	EFF mg/L	SUSPENDED SOLIDS LBS/DAY	BOD 5 mg/L	EFF mg/L	LBS/DAY	FECAL MPN	TURB NTU					TOTAL AMMONIA mg/L	TOTAL COPPER mg/L	TOTAL COPPER ug/L	TOTAL NICKEL mg/L	TOTAL NICKEL ug/L	
1	0.00	2.429	2.313	7.2	<0.05	<0.1							3.7	3.3	1	0.00	2.313							
2	0.00	2.335	2.217	7.2	<0.05	<0.1	154	6.5	120	129	6.7	124		3.5	2	0.00	2.217							
3	0.01	2.249	2.146	7.2	<0.05	<0.1							6.8	3.1	3	0.01	2.146							
4	0.14	2.181	2.128	7.2	<0.05	<0.1	171	7.3	130	119	6.6	117		3.4	4	0.14	2.128	12.0	3.7					
5	0.20	2.168	2.099	7.2	<0.05	<0.1								3.1	5	0.20	2.099							
6	0.00	2.071	2.052	7.2	<0.05	<0.1							4.0	2.4	6	0.00	2.052							
7	0.00	2.007	1.969	7.2	<0.05	<0.1	166	4.6	76	178	5.7	94		2.7	7	0.00	1.969	17.9	5.8					
8	0.00	1.919	1.925	7.3	<0.05	<0.1							<1.8	3.8	8	0.00	1.925							
9	0.00	1.868	1.918	7.2	<0.05	0.1	185	4.4	70	167	5.8	93		3.5	9	0.00	1.918		0.009	9.2	0.019	19	<5.0	
10	0.11	1.814	1.839	7.2	<0.05	<0.1							2	4.3	10	0.11	1.839							
11	0.39	1.894	1.915	7.2	<0.05	<0.1	271	4.9	78	205	5.9	94		3.3	11	0.39	1.915	16.4	6.4					
12	0.40	1.824	1.723	7.2	<0.05	<0.1								3.3	12	0.40	1.723							
13	0.19	1.877	2.005	7.2	<0.05	<0.1							4.5	4.3	13	0.19	2.005							
14	0.00	1.824	1.799	7.1	<0.05	<0.1	210	9.8	147	160	8.8	132		2.4	14	0.00	1.799	16.3	6.5					
15	0.12	1.719	1.723	7.2	<0.05	<0.1							<1.8	4.5	15	0.12	1.723							
16	0.84	2.047	2.006	7.2	<0.05	<0.1	176	6.1	102	167	7.5	125		3.4	16	0.84	2.006							
17	0.01	1.908	1.925	7.2	<0.05	0.1							6.8	4.7	17	0.01	1.925							
18	0.00	1.816	1.776	7.2	<0.05	<0.1	177	5.8	86	191	7.4	110		4.1	18	0.00	1.776	14.3	9.5					
19	0.00	1.743	1.751	7.2	<0.05	<0.1								3.4	19	0.00	1.751							
20	0.00	1.710	1.692	7.1	<0.05	<0.1							4	3.2	20	0.00	1.692							
21	0.00	1.690	1.671	7.2	<0.05	<0.1	209	5.9	82	210	7.7	107		2.7	21	0.00	1.671	13.4	4.1					
22	0.00	1.655	1.677	7.2	<0.05	<0.1							4.5	3.8	22	0.00	1.677							
23	0.00	1.607	1.637	7.2	<0.05	<0.1	157	6.3	86	151	7.4	101		3.6	23	0.00	1.637							
24	0.00	1.601	1.639	7.2	<0.05	<0.1								3.6	24	0.00	1.639							
25	0.00	1.555	1.553	7.2	<0.05	<0.1	187	6.2	80	210	8.5	110		3.8	25	0.00	1.553	21.1	8.9					
26	0.00	1.506	1.527	7.3	<0.05	<0.1								3.6	26	0.00	1.527							
27	0.00	1.472	1.523	7.1	<0.05	<0.1							6.8	1.8	27	0.00	1.523							
28	0.03	1.446	1.501	7.0	<0.05	<0.1	197	5.1	64	214	6.2	78		2.0	28	0.03	1.501	22.5	6.1					
29	0.04	1.479	1.541	7.2	<0.05	<0.1							7.8	3.2	29	0.04	1.541							
30	0.00	1.453	1.509	7.2	<0.05	<0.1	198	5.5	69	195	7	93		3.3	30	0.00	1.509							
31	0.08	1.427	1.501	7.2	<0.05	0.1								12.5	31	0.08	1.501							
TOTAL	2.56	56.29	56.20												TOTAL	2.56	56.20							

(MEDIAN)

AVG	0.08	1.816	1.813	7.2	<0.05	<0.1	189	6.0	92	177	7.0	106	4.5	3.7	AVG	0.08	1.813	16.7	6.4	0.009	9.2	0.019	19.0	<5.0
MIN	0.00	1.427	1.501	7.0	<0.05	<0.1	154	4.4	64	119	5.7	78	2	1.8	MIN	0.00	1.501	12.0	3.7	0.009	9.2	0.019	19.0	<5.0
MAX	0.84	2.429	2.313	7.3	<0.05	0.1	271	9.8	147	214	8.8	132	8	12.5	MAX	0.84	2.313	22.5	9.5	0.009	9.2	0.019	19.0	<5.0

DISCHARGE LIMITS:

INSTANT MAX.	1.8	3	225
DAILY MAX.	0.24	0.2	
7 DAY AVG.		45	700
30 DAY AVG.		0.1	30
DAILY MAX. OF 10%			43
pH	6.0/9.0		
SIX MONTH MEDIAN	0.06		

TSS 85% REMOVAL BOD 75% REMOVAL

ND = NON DETECTED NA = NOT ANALYZED

ANALYTE	METHOD USED	METHOD USED	PQL
TOTAL COPPER	EPA 200.7	EPA 200.7	0.020
TOTAL ZINC	EPA 200.7	EPA 200.7	0.050
GREASE & OIL	EPA 1664	EPA 1664	5.0
CHLOROFORM	EPA 624	EPA 624	0.50

42.31 TOTAL RAINFALL (year-to-date)

CALCULATED % REMOVALS
 TSS **96.81** BOD **96.01**

CITY OF CRESCENT CITY WPCF - SUMMARY OF TREATMENT REPORT

DISCHARGE MONITORING - PERMIT No. CA0022756
 ORDER # R1-2011-0019 ID # 1A84006ODN

CITY OF CRESCENT CITY WPCF - SUMMARY OF TREATMENT REPORT

DISCHARGE MONITORING - PERMIT No. CA0022756
 ORDER # R1-2011-0019 ID # 1A84006ODN

JUN 2017

ALL SAMPLES ARE FROM MONITORING LOCATION EFF-001 WITH
 EXCEPTION OF THE THREE IN BOLD MARKED INF

Page 1 JUN 2017

ALL SAMPLES ARE FROM MONITORING LOCATION EFF-001 WITH EXCEPTION OF THE
 THREE IN BOLD MARKED INF

Page 2

DAY	DAILY REQUIREMENTS						WEEKLY REQUIREMENTS						DAY	RAIN IN	FLOW MGD	INF TOTAL AMMONIA mg/L	ONE SAMPLE PER MONTH REQUIRED					GREASE & OIL mg/L			
	RAIN IN	INF FLOW MGD	FLOW MGD	pH	TOTAL CL ₂ mg/L	SETTLE SOLIDS EFF	SUSPENDED SOLIDS			BOD 5							FECAL MPN	TURB NTU	TOTAL AMMONIA mg/L	TOTAL COPPER mg/L	TOTAL COPPER ug/L		TOTAL NICKEL mg/L	TOTAL NICKEL ug/L	
							INF mg/L	EFF mg/L	LBS/DAY	INF mg/L	EFF mg/L	LBS/DAY													
1	0.00	1.399	1.443	7.2	<0.05	<0.1	204	5.0	60	231	10.5	126		4.6	1	0.00	1.443	25.2	12.4						
2	0.00	1.392	1.480	7.2	<0.05	<0.1								3.8	2	0.00	1.480								
3	0.00	1.343	1.403	7.2	<0.05	<0.1								7.8	3	0.00	1.403								
4	0.00	1.369	1.411	7.2	<0.05	<0.1	235	5.4	64	252	11.9	140		3.1	4	0.00	1.411	29.2	9.3						
5	0.00	1.356	1.434	7.4	<0.05	<0.1								4.5	5	0.00	1.434								
6	0.00	1.315	1.367	7.4	<0.05	<0.1								5.2	6	0.00	1.367								
7	1.00	1.347	1.445	7.3	<0.05	<0.1								4.5	7	1.00	1.445								
8	0.06	1.559	1.602	7.3	<0.05	<0.1	263	5.2	69	243	10.1	135		4.5	8	0.06	1.602	26.5	13.6						
9	0.44	1.397	1.507	7.4	<0.05	<0.1								4.4	9	0.44	1.507								
10	0.93	1.657	1.693	7.3	<0.05	<0.1								11	10	0.93	1.693								
11	0.00	1.547	1.602	7.3	<0.05	<0.1	183	9.0	120	196	13.9	186		3.5	11	0.00	1.602	20.9	7.7						
12	0.00	1.463	1.519	7.4	<0.05	<0.1								4	12	0.00	1.519								
13	0.00	1.427	1.452	7.4	<0.05	<0.1	201	5.7	69	206	9.1	110		5.4	13	0.00	1.452			0.012	12	0.011	11	<5.0	
14	0.00	1.403	1.491	7.2	<0.05	<0.1								17	14	0.00	1.491								
15	0.16	1.401	1.469	7.2	<0.05	<0.1	170	5.9	72	198	10.7	131		3.0	15	0.16	1.469	23.6	15.1						
16	0.03	1.406	1.484	7.3	<0.05	<0.1								3.3	16	0.03	1.484								
17	0.00	1.375	1.423	7.3	<0.05	<0.1								2	17	0.00	1.423								
18	0.00	1.349	1.349	7.2	<0.05	<0.1	231	6.2	70	264	12.2	137		3.0	18	0.00	1.349	26.9	13.1						
19	0.01	1.332	1.332	7.3	<0.05	<0.1								4.5	19	0.00	1.332								
20	0.00	1.367	1.367	7.4	<0.05	<0.1	233	5.7	65	270	11.3	129		4.8	20	0.00	1.367								
21	0.00	1.340	1.340	7.3	<0.05	<0.1								3.4	21	0.00	1.340								
22	0.00	1.320	1.320	7.2	<0.05	<0.1	206	4.6	51	237	11.1	122		2.8	22	0.00	1.320	21.9	11.2						
23	0.00	1.295	1.295	7.3	<0.05	<0.1								3.2	23	0.00	1.295								
24	0.00	1.275	1.275	7.2	<0.05	<0.1								6.8	24	0.00	1.275								
25	0.00	1.270	1.307	7.2	<0.05	<0.1	196	5.0	55	216	11.2	122		2.8	25	0.00	1.307	21.7	10.2						
26	0.01	1.247	1.330	7.3	<0.05	<0.1								23	26	0.01	1.330								
27	0.00	1.275	1.307	7.1	<0.05	<0.1	197	9.8	107	232	24.0	262		4.8	27	0.00	1.307								
28	0.00	1.278	1.370	7.2	<0.05	<0.1								4.6	28	0.00	1.370								
29	0.00	1.186	1.320	7.1	<0.05	<0.1	221	7.1	78	246	12.2	134		2.4	29	0.00	1.320	26.9	9.9						
30	0.00	1.230	1.366	7.3	<0.05	0.0								4.8	30	0.00	1.366								
TOTAL	2.64	40.92	42.50												TOTAL	2.63	42.50								

(MEDIAN)

AVG	0.09	1.364	1.417	7.3	<0.05	<0.1	212	6.2	73	233	12.4	145	5.7	3.9	AVG	0.09	1.417	24.8	11.4	0.012	12.0	0.011	11.0	<5.0
MIN	0.00	1.186	1.275	7.1	<0.05	<0.1	170	4.6	51	196	9.1	110	2	2.4	MIN	0.00	1.275	20.9	7.7	0.012	12.0	0.011	11.0	<5.0
MAX	1.00	1.657	1.693	7.4	<0.05	<0.1	263	9.8	120	270	24.0	262	23	8.1	MAX	1.00	1.693	29.2	15.1	0.012	12.0	0.011	11.0	<5.0

DISCHARGE LIMITS:

INSTANT MAX.	1.8	3													225
DAILY MAX.	0.24	0.2													
7 DAY AVG.							45	700		45				100	
30 DAY AVG.							0.1	30	465	30				75	
DAILY MAX. OF 10%														43	
pH	6.0/9.0														
SIX MONTH MEDIAN	0.06														

ND = NON DETECTED **NA = NOT ANALYZED**

ANALYTE	METHOD USED	METHOD USED	PQL
TOTAL COPPER	EPA 200.7	EPA 200.7	0.020
TOTAL ZINC	EPA 200.7	EPA 200.7	0.050
GREASE & OIL	EPA 1664	EPA 1664	5.0
CHLOROFORM	EPA 624	EPA 624	0.50

42.31 TOTAL RAINFALL (year-to-date)

CALCULATED % REMOVALS
 TSS **97.06** BOD **94.69**

CITY OF CRESCENT CITY WPCF - SUMMARY OF TREATMENT REPORT

DISCHARGE MONITORING - PERMIT No. CA0022756
ORDER # R1-2011-0019 ID # 1A84006ODN

CITY OF CRESCENT CITY WPCF - SUMMARY OF TREATMENT REPORT

DISCHARGE MONITORING - PERMIT No. CA0022756
ORDER # R1-2011-0019 ID # 1A84006ODN

JUL 2017

ALL SAMPLES ARE FROM MONITORING LOCATION EFF-001 WITH EXCEPTION OF THE THREE IN BOLD MARKED INF

Page 1

JUL 2017

ALL SAMPLES ARE FROM MONITORING LOCATION EFF-001 WITH EXCEPTION OF THE THREE IN BOLD MARKED INF

Page 2

DAY	DAILY REQUIREMENTS						WEEKLY REQUIREMENTS						DAY	RAIN IN	FLOW MGD	INF TOTAL AMMONIA mg/L	ONE SAMPLE PER MONTH REQUIRED					
	RAIN IN	INF FLOW MGD	FLOW MGD	pH	TOTAL CL ₂ mg/L	SETTLE SOLIDS EFF	INF mg/L	EFF mg/L	LBS/DAY	BOD 5 mg/L	MPN	TURB NTU					TOTAL AMMONIA mg/L	TOTAL AMMONIA lbs/day	TOTAL COPPER mg/L	TOTAL COPPER ug/L	TOTAL NICKEL mg/L	TOTAL NICKEL ug/L
1	0.00	1.227	1.317	7.1	<0.05	<0.1					49	1.9	1	0.00	1.317							
2	0.00	1.227	1.326	7.1	<0.05	<0.1	262	5.1	56	263	18.9	209	2	0.00	1.326	24.5	7.0					
3	0.00	1.228	1.385	7.3	<0.05	<0.1						4.5	3	0.00	1.385							
4	0.01	1.174	1.294	6.9	<0.05	0.1	205	6.8	73	236	11.3	122	4	0.01	1.294							
5	0.00	1.199	1.288	6.8	<0.05	<0.1						5	5	0.00	1.288							
6	0.00	1.190	1.292	7.0	<0.05	<0.1	219	5.0	54	284	8.6	93	6	0.00	1.292	25.8	5.4					
7	0.00	1.164	1.321	7.1	<0.05	<0.1							7	0.00	1.321							
8	0.00	1.137	1.267	6.9	<0.05	<0.1		5.6	61.2			12.9	8	0.00	1.267							
9	0.00	1.113	1.228	6.9	<0.05	<0.1	251	5.4	55	289	8.5	87	9	0.00	1.228	26.3	6.4					
10	0.00	1.136	1.138	7.0	<0.05	<0.1							10	0.00	1.138							
11	0.00	1.129	1.264	7.1	<0.05	<0.1	249	4.7	50	232	9.6	101	11	0.00	1.264							
12	0.00	1.132	1.254	7.1	<0.05	<0.1							12	0.00	1.254							
13	0.00	1.131	1.254	7.0	<0.05	0.2	244	6.7	70	268	11.8	123	13	0.00	1.254	25.1	6.2					
14	0.00	1.119	1.260	7.2	<0.05	<0.1							14	0.00	1.260							
15	0.00	1.087	1.297	7.2	<0.05	<0.1		5.6	58.3			10.0	15	0.00	1.297							
16	0.00	1.109	1.206	7.0	<0.05	<0.1	207	7.9	79				16	0.00	1.206	22.8	5.9					
17	0.00	1.101	1.239	7.0	<0.05	<0.1							17	0.00	1.239							
18	0.00	1.081	0.955	7.1	<0.05	<0.1	223	7.0	56	271	13.6	108	18	0.00	0.955							
19	0.00	1.091	0.666	7.2	<0.05	0.1							19	0.00	0.666							
20	0.00	1.121	0.809	7.2	<0.05	0.1	211	8.7	59	247	11.2	76	20	0.00	0.809	29.5	8.5					
21	0.00	1.089	0.702	7.1	<0.05	<0.1							21	0.00	0.702							
22	0.00	1.071	0.662	6.9	<0.05	<0.1		7.9	64.6			12.4	22	0.00	0.662							
23	0.00	1.077	0.693	7.0	<0.05	<0.1	239	5.9	34	340	11.6	67	23	0.00	0.693	30.3	7.2					
24	0.00	1.066	0.722	7.2	<0.05	<0.1							24	0.00	0.722							
25	0.00	1.088	0.752	7.2	<0.05	<0.1	176	8.3	52	246	16.2	102	25	0.00	0.752		0.016	16.0	0.014	14.0	<5.0	
26	0.00	1.092	0.789	7.3	<0.05	<0.1							26	0.00	0.789							
27	0.00	1.099	0.736	7.4	<0.05	<0.1	497	6.3	39	736	16.1	99	27	0.00	0.736	31.9	14.1					
28	0.00	1.070	0.768	7.3	<0.05	0.1							28	0.00	0.768							
29	0.00	1.060	0.746	7.3	<0.05	0.1		6.8	41.6			14.6	29	0.00	0.746							
30	0.00	1.061	0.703	7.3	<0.05	<0.1	232	7.1	42	279	13	78	30	0.00	0.703	30.3	12.3					
31	0.00	1.031	0.936	7.3	<0.05	0.2							31	0.00	0.936							
TOTAL	0.01	34.70	32.27										TOTAL	0.01	32.27							

(MEDIAN)

AVG	0.00	1.119	1.041	7.1	<0.05	<0.1	247	6.5	55	308	12.6	105	7.3	AVG	0.00	1.041	27.4	8.1	0.016	16.0	0.014	14.0	<5.0
MIN	0.00	1.031	0.662	6.8	<0.05	<0.1	176	4.7	34	232	8.5	67	<1.8	MIN	0.00	0.662	22.8	5.4	0.016	16.0	0.014	14.0	<5.0
MAX	0.01	1.228	1.385	7.4	<0.05	0.2	497	8.7	79	736	18.9	209	10.0	MAX	0.01	1.385	31.9	14.1	0.016	16.0	0.014	14.0	<5.0

DISCHARGE LIMITS:																							
INSTANT MAX.				1.8		3							225	ND = NON DETECTED									NA = NOT ANALYZED
DAILY MAX.				0.24		0.2																	
7 DAY AVG.							45		700		45		100										
30 DAY AVG.							0.1		30		465		30										
DAILY MAX. OF 10%																							
pH				6.0/9.0																			
SIX MONTH MEDIAN					0.06																		
						TSS 85% REMOVAL				BOD 75% REMOVAL													

ANALYTE	METHOD USED	METHOD USED	PQL
TOTAL COPPER	EPA 200.7	EPA 200.7	0.020
TOTAL ZINC	EPA 200.7	EPA 200.7	0.050
GREASE & OIL	EPA 1664	EPA 1664	5.0
CHLOROFORM	EPA 624	EPA 624	0.50

42.31 TOTAL RAINFALL (year-to-date)

CALCULATED % REMOVALS
TSS 97.36 BOD 95.92

CITY OF CRESCENT CITY WPCF - SUMMARY OF TREATMENT REPORT

DISCHARGE MONITORING - PERMIT No. CA0022756

ORDER # R1-2011-0019 ID # 1A84006ODN

CITY OF CRESCENT CITY WPCF - SUMMARY OF TREATMENT REPORT

DISCHARGE MONITORING - PERMIT No. CA0022756

ORDER # R1-2011-0019 ID # 1A84006ODN

AUG 2017

ALL SAMPLES ARE FROM MONITORING LOCATION EFF-001 WITH EXCEPTION OF THE THREE IN BOLD MARKED INF

Page 1

AUG 2017

ALL SAMPLES ARE FROM MONITORING LOCATION EFF-001 WITH EXCEPTION OF THE THREE IN BOLD MARKED INF

Page 2

DAY	DAILY REQUIREMENTS						WEEKLY REQUIREMENTS										DAY	RAIN IN	FLOW MGD	INF TOTAL AMMONIA mg/L					GREASE & OIL mg/L					
	RAIN IN	INF FLOW MGD	FLOW MGD	pH	TOTAL CL ₂ mg/L	SETTLE SOLIDS EFF	SUSPENDED SOLIDS			BOD 5			FECAL MPN	TURB NTU	TOTAL AMMONIA mg/L	TOTAL AMMONIA mg/L				TOTAL COPPER mg/L	TOTAL COPPER ug/L	TOTAL NICKEL mg/L	TOTAL NICKEL ug/L							
							INF mg/L	EFF mg/L	LBS/DAY	INF mg/L	EFF mg/L	LBS/DAY																		
1	0.00	1.077	1.322	7.3	<0.05	<0.1								4.5	5.2	1	0.00	1.322												
2	0.00	1.099	1.236	7.3	<0.05	<0.1								4.5	3.6	2	0.00	1.236												
3	0.00	1.104	1.268	7.3	<0.05	<0.1	250	5.1		54				271	9.6	102			32.6	7.8										
4	0.00	1.083	1.273	7.3	<0.05	<0.1									4.1		4	0.00	1.273											
5	0.00	1.068	1.260	7.3	<0.05	<0.1	232	6.3	5.7	66	60.1			277	13.7	11.7	144	122.7	23	4.0	4.0	5	0.00	1.260	34.9	14.3				
6	0.00	1.057	1.228	7.2	<0.05	<0.1	222	6.0		61				289	13.4	137						6	0.00	1.228						
7	0.00	1.053	1.464	7.3	<0.05	<0.1								4.5	4.8				4.5	4.8		7	0.00	1.464						
8	0.00	1.092	1.567	7.1	<0.05	<0.1	248	7.4		97				295	14.1	184						8	0.00	1.567						
9	0.00	1.078	1.599	7.2	<0.05	<0.1								4.5	3.0				4.5	3.0		9	0.00	1.599						
10	0.02	1.068	1.071	7.2	<0.05	<0.1	333	5.6		50				376	13.0	116						10	0.02	1.071	30.7	11.6				
11	0.02	1.052	0.881	7.3	<0.05	<0.1									5.4							11	0.02	0.881						
12	0.02	1.038	0.888	7.2	<0.05	0.1			6.3		69.4				13.5		145.9	8	2.5	3.5	12	0.02	0.888							
13	0.00	1.033	0.830	7.2	<0.05	<0.1	315	6.1		42				348	11.8	82						13	0.00	0.830	36.5	12.8				
14	0.00	1.041	0.862	7.3	<0.05	0.1								4.5	3.2				4.5	3.2		14	0.00	0.862						
15	0.00	1.043	0.847	7.2	<0.05	<0.1	258	6.8		48				280	12.5	88						15	0.00	0.847		0.015	15.0	0.011	11.0	<5.0
16	0.00	1.044	0.896	7.3	<0.05	<0.1								2	2.7				2	2.7		16	0.00	0.896						
17	0.00	1.051	0.877	7.3	<0.05	<0.1	273	6.5		48				297	12.6	92						17	0.00	0.877	30.9	11.9				
18	0.00	1.024	0.908	7.4	<0.05	<0.1									6.3							18	0.00	0.908						
19	0.00	1.010	0.867	7.2	<0.05	<0.1			6.5		45.9				12.3		87.4	4	2.8	3.2	19	0.00	0.867							
20	0.00	0.997	0.867	7.3	<0.05	<0.1	233	7.4		54				289	11.7	85						20	0.00	0.867	28.5	9.1				
21	0.00	0.999	0.899	7.3	<0.05	<0.1								1.8	5.0				1.8	5.0		21	0.00	0.899						
22	0.00	1.028	0.919	7.3	<0.05	0.1	261	6.1		47				301	11.8	90						22	0.00	0.919						
23	0.00	1.049	0.907	7.2	<0.05	<0.1									3.0							23	0.00	0.907						
24	0.01	1.017	0.883	7.2	<0.05	<0.1	264	7.1		52				320	14.4	106						24	0.01	0.883	27.7	10.1				
25	0.00	1.067	0.905	7.3	<0.05	0.1									4.9							25	0.00	0.905						
26	0.00	1.050	0.887	7.3	<0.05	<0.1			6.9		50.8				12.6		93.7	23	4.0	4.1	26	0.00	0.887							
27	0.00	1.086	0.867	7.2	<0.05	<0.1	260	6.5		47				322	15.8	114						27	0.00	0.867	35.8	13.1				
28	0.00	1.102	0.933	7.2	<0.05	<0.1								4.5	6.6				4.5	6.6		28	0.00	0.933						
29	0.02	1.112	0.917	7.1	<0.05	<0.1	217	7.1		54				261	16.8	128						29	0.02	0.917						
30	0.00	1.067	0.873	7.2	<0.05	<0.1									3.6							30	0.00	0.873						
31	0.00	1.071	0.894	7.4	<0.05	<0.1	325	6.5	6.7	48	49.9			397	14.3	15.6	107	116.4				31	0.00	0.894	33.0	8.8				
TOTAL	0.09	32.76	31.90																			TOTAL	0.09	31.90						

(MEDIAN)

AVG	0.00	1.057	1.029	7.3	<0.05	<0.1	264	6.5		55				309	13.3	113			4.5	3.9	4.1	AVG	0.00	1.029	32.3	11.1	0.015	15.0	0.011	11.0	<5.0
MIN	0.00	0.997	0.830	7.1	<0.05	<0.1	217	5.1		42				261	9.6	82			1.8	2.0		MIN	0.00	0.830	27.7	7.8	0.015	15.0	0.011	11.0	<5.0
MAX	0.02	1.112	1.599	7.4	<0.05	0.1	333	7.4		97				397	16.8	184			23	6.6		MAX	0.02	1.599	36.5	14.3	0.015	15.0	0.011	11.0	<5.0

DISCHARGE LIMITS:

INSTANT MAX. 1.8 3 225

DAILY MAX. 0.24 0.2

7 DAY AVG. 45 700 45

30 DAY AVG. 30 465 30

DAILY MAX. OF 10% pH 6.0/9.0

SIX MONTH MEDIAN 0.06

TSS 85% REMOVAL BOD 75% REMOVAL

ND = NON DETECTED

NA = NOT ANALYZED

ANALYTE	METHOD USED	METHOD USED	PQL
TOTAL COPPER	EPA 200.7	EPA 200.7	0.020
TOTAL ZINC	EPA 200.7	EPA 200.7	0.050
GREASE & OIL	EPA 1664	EPA 1664	5.0
CHLOROFORM	EPA 624	EPA 624	0.50

42.31	TOTAL RAINFALL (year-to-date)	TSS 97.55	CALCULATED % REMOVALS	BOD 95.71
-------	-------------------------------	-----------	-----------------------	-----------

CITY OF CRESCENT CITY WPCF - SUMMARY OF TREATMENT REPORT
DISCHARGE MONITORING - PERMIT No. CA0022756
ORDER # R1-2011-0019 ID # 1A84006ODN

CITY OF CRESCENT CITY WPCF - SUMMARY OF TREATMENT REPORT
DISCHARGE MONITORING - PERMIT No. CA0022756
ORDER # R1-2011-0019 ID # 1A84006ODN

DAY	DAILY REQUIREMENTS						WEEKLY REQUIREMENTS						ONE SAMPLE PER MONTH REQUIRED											
	RAIN IN	INF FLOW MGD	FLOW MGD	pH	TOTAL CL ₂ mg/L	SETTLE SOLIDS EFF	INF mg/L	EFF mg/L	LBS/DAY	BOD 5 INF mg/L	EFF mg/L	LBS/DAY	FECAL MPN	TURB NTU	DAY	RAIN IN	FLOW MGD	INF TOTAL AMMONIA mg/L	TOTAL AMMONIA mg/L	TOTAL COPPER mg/L	TOTAL COPPER ug/L	TOTAL NICKEL mg/L	TOTAL NICKEL ug/L	GREASE & OIL mg/L
1	0.00	1.053	0.912	7.4	<0.05	<0.1								6.0	1	0.00	0.912							
2	0.00	1.059	0.875	7.1	<0.05	<0.1							4.5	1.7	2	0.00	0.875							
3	0.00	1.049	0.866	7.2	<0.05	0.2	243	7.4	53	276	15.2	110		3.4	3	0.00	0.866	31.6	10.4					
4	0.00	0.910	1.046	7.2	<0.05	<0.1							2	3.6	4	0.00	1.046							
5	0.00	1.027	0.873	7.2	<0.05	0.1	238	7.9	58	263	17.0	124		3.7	5	0.00	0.873							
6	0.00	1.059	0.926	7.4	<0.05	0.1							6.8	6.2	6	0.00	0.926							
7	0.27	1.064	0.884	7.4	<0.05	0.1	239	6.7	49	277	13.6	100		6.0	7	0.27	0.884	32.7	13.4					
8	0.02	1.048	0.915	7.5	<0.05	0.1								10.8	8	0.02	0.915							
9	0.00	0.968	0.885	7.2	<0.05	<0.1		7.3	53.5		15.3	111.3	4.5	2.4	9	0.00	0.885							
10	0.00	0.984	0.846	7.2	<0.05	<0.1	212	6.0	42	315	10.2	72		1.1	10	0.00	0.846	32.5	11.1					
11	0.00	0.963	0.866	7.3	<0.05	<0.1							2	5.0	11	0.00	0.866							
12	0.00	0.987	0.863	7.2	<0.05	<0.1	311	7.4	53	334	12.3	89		4.2	12	0.00	0.863							
13	0.00	1.012	0.903	7.3	<0.05	<0.1							<1.8	4.4	13	0.00	0.903							
14	0.00	1.026	0.835	7.4	<0.05	<0.1	251	7.1	49	281	11.6	81		6.4	14	0.00	0.835	32.5	11.8					
15	0.00	0.997	0.846	7.4	<0.05	<0.1								2.4	15	0.00	0.846							
16	0.00	0.989	0.850	7.2	<0.05	<0.1		6.8	48.3		11.4	80.4	4.5	2.4	16	0.00	0.850							
17	0.30	0.855	1.029	7.2	<0.05	<0.1	94.4	8.3	71	199	20.6	177		2.6	17	0.30	1.029	34.2	11.0					
18	0.02	1.026	0.899	7.4	<0.05	<0.1							2	5.9	18	0.02	0.899							
19	0.48	1.053	0.878	7.2	<0.05	<0.1	239	7.7	56	299	12.1	89		3.4	19	0.00	0.878		0.015	15.0	0.011	11.0	<5.0	
20	0.03	1.062	0.934	7.3	<0.05	<0.1							5	4.5	20	0.03	0.934							
21	0.01	1.015	0.841	7.2	<0.05	0.1	367	7.7	54					2.9	21	0.01	0.841	29.0	11.0					
22	0.00	1.001	0.862	7.3	<0.05	<0.1				300	12.0	86		3.5	22	0.00	0.862							
23	0.00	1.024	0.846	7.2	<0.05	0.1		7.9	60.5		14.9	117.2	11	3.4	23	0.00	0.846							
24	0.00	1.029	0.842	7.2	<0.05	<0.1	317	7.5	53	375	10.9	77		2.4	24	0.00	0.842	30.0	8.8					
25	0.00	1.006	0.876	7.4	<0.05	0.1				291	10.6	77		6.1	25	0.00	0.876							
26	0.00	1.003	0.826	7.3	<0.05	<0.1	280	7.4	89					4.2	26	0.00	0.826							
27	0.00	1.001	0.856	7.2	<0.05	<0.1								3.5	27	0.00	0.856							
28	0.00	1.000	0.847	7.3	<0.05	<0.1	315	10.2	81	280	12.0	85		3.8	28	0.00	0.847	32.8	10.2					
29	0.04	0.971	0.865	7.4	<0.05	<0.1								6.6	29	0.04	0.865							
30	0.00	0.994	0.822	7.1	<0.05	<0.1		8.4	74.0		11.2	79.6	2	2.2	30	0.00	0.822							
TOTAL	1.17	30.24	26.41												TOTAL	0.69	26.41							

	AVG	MIN	MAX	RAIN IN	INF FLOW MGD	FLOW MGD	pH	TOTAL CL ₂ mg/L	SETTLE SOLIDS EFF	INF mg/L	EFF mg/L	LBS/DAY	BOD 5 INF mg/L	EFF mg/L	LBS/DAY	FECAL MPN	TURB NTU	DAY	RAIN IN	FLOW MGD	INF TOTAL AMMONIA mg/L	TOTAL AMMONIA mg/L	TOTAL COPPER mg/L	TOTAL COPPER ug/L	TOTAL NICKEL mg/L	TOTAL NICKEL ug/L	GREASE & OIL mg/L
(MEDIAN)	0.04	0.00	0.48	0.00	1.008	0.880	7.3	<0.05	<0.1	259	7.6	59	291	13.2	97	4.5	4.2	5.2	0.02	0.880	31.9	11.0	0.015	15.0	0.011	11.0	<5.0
	0.00	0.855	1.064	0.00	0.822	0.822	7.1	<0.05	<0.1	94	6.0	42	199	10.2	72	<1.8	1.1	5.2	0.00	0.822	29.0	8.8	0.015	15.0	0.011	11.0	<5.0
	0.48	1.064	1.046	0.00	1.046	1.046	7.5	<0.05	0.2	367	10.2	89	375	20.6	177	11	10.8	5.2	0.30	1.046	34.2	13.4	0.015	15.0	0.011	11.0	<5.0

DISCHARGE LIMITS:

INSTANT MAX. 1.8 3 225

DAILY MAX. 0.24 0.2

7 DAY AVG. 45 700 45 100

30 DAY AVG. 0.1 30 465 30 75

DAILY MAX. OF 10% 43

pH 6.0/9.0

SIX MONTH MEDIAN 0.06

TSS 85% REMOVAL CALCULATED % REMOVALS BOD 75% REMOVAL

ND = NON DETECTED NA = NOT ANALYZED

ANALYTE	METHOD USED	METHOD USED	PQL
TOTAL COPPER	EPA 200.7	EPA 200.7	0.020
TOTAL ZINC	EPA 200.7	EPA 200.7	0.050
GREASE & OIL	EPA 1664	EPA 1664	5.0
CHLOROFORM	EPA 624	EPA 624	0.50

42.31 TOTAL RAINFALL (year-to-date)

TSS 97.06 BOD 95.47

CITY OF CRESCENT CITY WPCF - SUMMARY OF TREATMENT REPORT
 DISCHARGE MONITORING - PERMIT No. CA0022756
 ORDER # R1-2011-0019 ID # 1A84006ODN

CITY OF CRESCENT CITY WPCF - SUMMARY OF TREATMENT REPORT
 DISCHARGE MONITORING - PERMIT No. CA0022756
 ORDER # R1-2011-0019 ID # 1A84006ODN

OCT 2017

ALL SAMPLES ARE FROM MONITORING LOCATION EFF-001 WITH EXCEPTION OF THE THREE IN BOLD MARKED INF

Page 1

OCT 2017

ALL SAMPLES ARE FROM MONITORING LOCATION EFF-001 WITH EXCEPTION OF THE THREE IN BOLD MARKED INF

Page 2

DAY	DAILY REQUIREMENTS						WEEKLY REQUIREMENTS										ONE SAMPLE PER MONTH REQUIRED							
	RAIN IN	INF FLOW MGD	FLOW MGD	pH	TOTAL CL ₂ mg/L	SETTLE SOLIDS EFF	INF mg/L	EFF mg/L	LBS/DAY	INF mg/L	EFF mg/L	LBS/DAY	FECAL MPN	TURB NTU	DAY	RAIN IN	FLOW MGD	INF TOTAL AMMONIA mg/L	TOTAL AMMONIA mg/L	TOTAL COPPER mg/L	TOTAL COPPER ug/L	TOTAL NICKEL mg/L	TOTAL NICKEL ug/L	GREASE & OIL mg/L
1	0.00	0.989	0.870	7.3	<0.05	<0.1	224	6.1	44	286	8.4	61		2.9	1	0.00	0.870	34.6	8.7					
2	0.00	0.975	0.819	7.2	<0.05	<0.1							2	2.8	2	0.00	0.819							
3	0.00	0.981	0.866	7.2	7.2	<0.1	449	5.3	38	600	7.5	54		1.8	3	0.00	0.866							
4	0.00	1.001	0.827	7.2	<0.05	<0.1							2	1.3	4	0.00	0.827							
5	0.00	0.996	0.869	7.3	<0.05	<0.1	291	6.3	46	248	7.5	54		2.8	5	0.00	0.869	33.7	8.1					
6	0.00	0.989	0.845	7.3	<0.05	<0.1								1.2	6	0.00	0.845							
7	0.00	0.984	0.856	7.2	<0.05	<0.1		5.9	42.7		7.8	56.5	7.8	1.2	7	0.00	0.856							
8	0.00	1.006	0.849	7.2	<0.05	<0.1	267	5.6	40	307	7.4	52		1.2	8	0.00	0.849	34.8	10.2					
9	0.00	0.971	0.831	7.2	<0.05	<0.1							4.5	1.3	9	0.00	0.831							
10	0.00	1.016	0.828	7.3	<0.05	<0.1	251	5.6	39	280	8.1	56		1.8	10	0.00	0.828		0.009	9.5	0.008	8.2	<5.0	
11	0.26	1.011	0.892	7.4	<0.05	<0.1							2	3.4	11	0.26	0.892							
12	0.00	0.985	0.822	7.3	<0.05	<0.1	431	8.6	59	273	9.3	64		1.2	12	0.00	0.822	26.9	10.5					
13	0.00	0.952	0.820	7.5	<0.05	<0.1								1.7	13	0.00	0.820							
14	0.00	0.961	0.830	7.2	<0.05	<0.1		6.6	45.8		8.3	57.4	4.5	1.2	14	0.00	0.830							
15	0.00	0.962	0.863	7.1	<0.05	<0.1	273	4.2	30	285	6.9	50		1.7	15	0.00	0.863	33.2	6.9					
16	0.00	0.948	0.795	7.2	<0.05	0.2							2	1.9	16	0.00	0.795							
17	0.00	0.953	0.843	7.2	<0.05	0.1	190	5.8	41	246	8.7	61		2.6	17	0.00	0.843							
18	0.00	0.964	0.821	7.2	<0.05	<0.1							4	2.4	18	0.00	0.821							
19	1.55	1.143	1.002	7.3	<0.05	<0.1	273	6.2	52	299	9.5	79		3.7	19	0.00	1.002	36.3	6.9					
20	0.25	1.051	0.939	7.4	<0.05	<0.1								6.8	20	0.25	0.939							
21	0.40	1.101	1.001	7.3	<0.05	<0.1		5.4	40.9		8.4	63.4	17.0	3.0	3.2	21	0.40	1.001						
22	0.17	1.079	0.963	7.3	<0.05	<0.1	375	6.7	54	213	11.6	93		3.1	22	0.17	0.963	28.8	11.7					
23	0.00	1.029	0.909	7.5	<0.05	<0.1							6.8	3.5	23	0.00	0.909							
24	0.00	1.022	0.890	7.3	<0.05	<0.1	233	5.5	41	287	11.0	82		3.4	24	0.00	0.890							
25	0.00	1.017	0.891	7.2	<0.05	<0.1							4.5	2.9	25	0.00	0.891							
26	0.03	1.016	0.874	7.3	<0.05	0.2	235	5.9	43	251	10.2	74		4.9	26	0.03	0.874	34.7	9.8					
27	0.01	1.016	0.853	7.4	<0.05	<0.1								6.4	27	0.01	0.853							
28	0.03	0.980	0.883	7.2	<0.05	<0.1		6.0	45.9		10.9	83.1	4.5	2.8	3.9	28	0.03	0.883						
29	0.00	0.995	0.851	7.1	<0.05	<0.1	235	6.1	43	272	10.3	73		2.3	29	0.00	0.851	32.1	12.0					
30	0.02	0.981	0.851	7.3	<0.05	<0.1							13	4.3	30	0.02	0.851							
31	0.01	0.959	0.856	7.3	<0.05	<0.1	246	5.9	42	304	9.3	66		3.9	31	0.01	0.856							
TOTAL	2.73	31.03	26.91												TOTAL	1.18	26.91							

(MEDIAN)																										
AVG	0.09	1.001	0.868	7.3	<0.05	<0.1	284	6.0	44		297	9.0	66	4.5	2.8	3.9	AVG	0.04	0.868	32.8	9.4	0.009	9.5	0.008	8.2	<5.0
MIN	0.00	0.948	0.795	7.1	<0.05	<0.1	190	4.2	30		213	6.9	50	2	1.2		MIN	0.00	0.795	26.9	6.9	0.009	9.5	0.008	8.2	<5.0
MAX	1.55	1.143	1.002	7.5	<0.05	0.2	449	8.6	59		600	11.6	93	17	6.8		MAX	0.40	1.002	36.3	12.0	0.009	9.5	0.008	8.2	<5.0

DISCHARGE LIMITS:

INSTANT MAX.	1.8	3														225
DAILY MAX.	0.24	0.2														
7 DAY AVG.							45	700		45						100
30 DAY AVG.								30	465		30					75
DAILY MAX. OF 10% pH	6.09.0															43
SIX MONTH MEDIAN		0.06														

TSS 85% REMOVAL BOD 75% REMOVAL

CALCULATED % REMOVALS

TSS **97.89** BOD **96.97**

ND = NON DETECTED **NA = NOT ANALYZED**

ANALYTE	METHOD USED	METHOD USED	PQL
TOTAL COPPER	EPA 200.7	EPA 200.7	0.020
TOTAL ZINC	EPA 200.7	EPA 200.7	0.050
GREASE & OIL	EPA 1664	EPA 1664	5.0
CHLOROFORM	EPA 624	EPA 624	0.50

42.31 TOTAL RAINFALL (year-to-date)

CITY OF CRESCENT CITY WPCF - SUMMARY OF TREATMENT REPORT
 DISCHARGE MONITORING - PERMIT No. CA0022756
 ORDER # R1-2011-0019 ID # 1A84006ODN

CITY OF CRESCENT CITY WPCF - SUMMARY OF TREATMENT REPORT
 DISCHARGE MONITORING - PERMIT No. CA0022756
 ORDER # R1-2011-0019 ID # 1A84006ODN

NOV 2017

ALL SAMPLES ARE FROM MONITORING LOCATION EFF-001 WITH EXCEPTION OF THE THREE IN BOLD MARKED INF

Page 1

NOV 2017

ALL SAMPLES ARE FROM MONITORING LOCATION EFF-001 WITH EXCEPTION OF THE THREE IN BOLD MARKED INF

Page 2

DAY	DAILY REQUIREMENTS						WEEKLY REQUIREMENTS										ONE SAMPLE PER MONTH REQUIRED							
	RAIN IN	INF FLOW MGD	FLOW MGD	pH	TOTAL CL ₂ mg/L	SETTLE SOLIDS EFF	INF mg/L	EFF mg/L	LBS/DAY	INF mg/L	EFF mg/L	LBS/DAY	FECAL MPN	TURB NTU	DAY	RAIN IN	FLOW MGD	INF TOTAL AMMONIA mg/L	TOTAL AMMONIA mg/L	TOTAL COPPER mg/L	TOTAL COPPER ug/L	TOTAL NICKEL mg/L	TOTAL NICKEL ug/L	GREASE & OIL mg/L
1	0.03	0.990	0.852	7.2	<0.05	<0.1							13	3.3	1	0.03	0.852							
2	0.83	1.024	0.869	7.4	<0.05	<0.1	261	7.6	55	254	11.7	85		5.8	2	0.83	0.869	27.5	7.7					
3	0.09	1.136	1.008	7.4	<0.05	<0.1								6.1	3	0.09	1.008							
4	0.10	1.049	0.869	7.1	<0.05	<0.1							<1.8	2.7	4	0.10	0.869							
5	0.33	1.114	0.950	7.2	<0.05	<0.1	229	6.3	50	245	10.6	84		3.0	5	0.33	0.950	29.2	10.2					
6	0.00	1.041	0.895	7.3	<0.05	<0.1							4.5	5.3	6	0.00	0.895	32.6	8.2					
7	0.00	1.038	0.874	7.2	<0.05	<0.1	263	6.3	46	203	11.9	87		3.8	7	0.00	0.874							
8	1.52	1.179	1.061	7.3	<0.05	<0.1							11	6.5	8	1.52	1.061							
9	0.95	1.293	1.101	7.4	<0.05	<0.1	231	8.9	82	238	17.4	160		7.1	9	0.95	1.101	27.8	13.3					
10	0.60	1.365	1.204	7.4	<0.05	<0.1								6.2	10	0.60	1.204							
11	0.00	1.174	1.024	7.1	<0.05	<0.1		7.2	59.2			13.3		110.2	7.8	2.6	4.9	11	0.00	1.024				
12	0.39	1.163	0.993	7.1	<0.05	<0.1	229	5.6	46	265	12.7	105		1.7	12	0.39	0.993	30.5	10.4					
13	0.38	1.237	1.086	7.4	<0.05	<0.1							2.0	6.7	13	0.38	1.086							
14	0.02	1.193	0.996	7.3	<0.05	<0.1	219	6.1	51	232	12.3	102		4.8	14	0.02	0.996		0.011	11.0	0.008	8.3	<5.0	
15	1.07	1.345	1.171	7.3	<0.05	<0.1							920.0	4.7	15	1.07	1.171							
16	0.51	1.507	1.325	7.4	<0.05	<0.1	258	10.8	119	245	19.6	217		6.9	16	0.51	1.325	23.4	11.4					
17	0.01	1.401	1.201	7.4	<0.05	<0.1							7	5.5	17	0.01	1.201							
18	0.00	1.302	1.100	7.2	<0.05	<0.1		7.5	72.1			14.9		141.3	4.3	4.9	18	0.00	1.100					
19	1.05	1.277	1.095	7.2	<0.05	<0.1	192	6.2	57	239	13.7	125		<1.8	3.2	19	0.00	1.095	23.6	7.7				
20	1.53	2.111	1.660	7.4	<0.05	<0.1							7.8	7.7	20	1.53	1.660							
21	0.22	1.858	1.593	7.3	<0.05	<0.1	147	11.1	147	187	20.8	276		7.4	21	0.22	1.593							
22	0.72	1.805	1.513	7.3	<0.05	<0.1								5.5	22	0.72	1.513							
23	0.71	2.104	1.793	7.4	<0.05	<0.1	145	6.6	99	204	16.5	247		6.3	23	0.71	1.793	18.8	10.3					
24	0.01	1.835	1.559	7.3	<0.05	<0.1								5.1	24	0.01	1.559							
25	0.15	1.652	1.448	7.3	<0.05	<0.1		8.0	100.9			17.0		216.1	5.9	5.9	25	0.15	1.448					
26	0.80	1.769	1.524	7.3	<0.05	<0.1	138	5.9	75					5.8	26	0.80	1.524	19.4	10.1					
27	0.01	1.844	1.683	7.4	<0.05	<0.1							4.5	6.6	27	0.01	1.683							
28	0.24	1.731	1.440	7.3	<0.05	<0.1	137	7.1	85	174	18.2	219		7.0	28	0.24	1.440							
29	0.01	1.607	1.383	7.4	<0.05	<0.1				86.3				7.5	29	0.01	1.383							
30	0.00	1.522	1.375	7.3	<0.05	<0.1	143	7.4	85	173	16.3	187		10.4	30	0.00	1.375							
TOTAL	12.28	42.67	36.65						6.8							11.23	36.65							

	(MEDIAN)																									
AVG	0.41	1.422	1.222	7.3	<0.05	<0.1	199	7.4	77	222	15.1	158	7.8	5.5	AVG	0.37	1.222	25.9	9.9	0.011	11.0	0.008	8.3	<5.0		
MIN	0.00	0.990	0.852	7.1	<0.05	<0.1	137	5.6	46	173	10.6	84	<1.8	1.7	MIN	0.00	0.852	18.8	7.7	0.011	11.0	0.008	8.3	<5.0		
MAX	1.53	2.111	1.793	7.4	<0.05	<0.1	263	11.1	147	265	20.8	276	920	10.4	MAX	1.53	1.793	32.6	13.3	0.011	11.0	0.008	8.3	<5.0		

DISCHARGE LIMITS:

INSTANT MAX.	1.8	3	225
DAILY MAX.	0.24	0.2	
7 DAY AVG.		45	700
30 DAY AVG.		0.1	30
DAILY MAX. OF 10%			465
pH	6.09.0		30
SIX MONTH MEDIAN	0.06		

ND = NON DETECTED

NA = NOT ANALYZED

ANALYTE	METHOD USED	METHOD USED	PQL
TOTAL COPPER	EPA 200.7	EPA 200.7	0.020
TOTAL ZINC	EPA 200.7	EPA 200.7	0.050
GREASE & OIL	EPA 1664	EPA 1664	5.0
CHLOROFORM	EPA 624	EPA 624	0.50

42.31 TOTAL RAINFALL (year-to-date)

CALCULATED % REMOVALS
 TSS 96.30 BOD 93.17

CITY OF CRESCENT CITY WPCF - SUMMARY OF TREATMENT REPORT
DISCHARGE MONITORING - PERMIT No. CA0022756
ORDER # R1-2011-0019 ID # 1A84006ODN

CITY OF CRESCENT CITY WPCF - SUMMARY OF TREATMENT REPORT
DISCHARGE MONITORING - PERMIT No. CA0022756
ORDER # R1-2011-0019 ID # 1A84006ODN

DEC 2017

ALL SAMPLES ARE FROM MONITORING LOCATION EFF-001 WITH EXCEPTION OF THE THREE IN BOLD MARKED INF

Page 1

DEC 2017

ALL SAMPLES ARE FROM MONITORING LOCATION EFF-001 WITH EXCEPTION OF THE THREE IN BOLD MARKED INF

Page 2

DAY	DAILY REQUIREMENTS						WEEKLY REQUIREMENTS										DAY	RAIN IN	FLOW MGD	INF TOTAL AMMONIA mg/L	ONE SAMPLE PER MONTH REQUIRED					GREASE & OIL mg/L
	RAIN IN	INF FLOW MGD	FLOW MGD	pH	TOTAL CL ₂ mg/L	SETTLE SOLIDS EFF	SUSPENDED SOLIDS			BOD 5				FECAL MPN	TURB NTU	TOTAL AMMONIA mg/L					TOTAL COPPER mg/L	TOTAL COPPER ug/L	TOTAL NICKEL mg/L	TOTAL NICKEL ug/L		
	INF mg/L	EFF mg/L	LBS/DAY	INF mg/L	EFF mg/L	LBS/DAY	FECAL MPN	TURB NTU	MPN	NTU	MPN	NTU	MPN	NTU	MPN	NTU					MPN	NTU				
1	0.00	1.429	1.236	7.4	<0.05	<0.1																				
2	0.92	1.585	1.340	7.3	<0.05	<0.1																				
3	0.01	1.780	1.460	7.4	<0.05	<0.1	196	8.8	107	177	18.2	222														
4	0.00	1.578	1.350	7.5	<0.05	<0.1																				
5	0.00	1.517	1.268	7.4	<0.05	<0.1	246	4.5	48	225	14.7	155														
6	0.00	1.445	1.235	7.4	<0.05	0.1																				
7	0.00	1.386	1.169	7.5	<0.05	0.1	153	7.7	75	168	15.5	151														
8	0.00	1.324	1.177	7.4	<0.05	<0.1																				
9	0.00	1.320	1.125	7.3	<0.05	<0.1			7.0			76.6														
10	0.00	1.311	1.106	7.3	<0.05	<0.1	172	7.1	65			171	16.6	153												
11	0.00	1.253	1.094	7.4	<0.05	<0.1																				
12	0.00	1.241	0.993	7.0	<0.05	0.1	159	7.0	58	215	17.8	147														
13	0.00	1.270	1.103	7.4	<0.05	<0.1																				
14	0.00	1.248	1.061	7.4	<0.05	<0.1	188	8.9	79	241	20.9	185														
15	0.00	1.182	1.081	7.4	<0.05	<0.1																				
16	0.00	1.161	1.000	7.2	<0.05	<0.1			7.7			67.4														
17	0.00	1.154	0.989	7.2	<0.05	<0.1	205	7.3	60	252	19.9	164														
18	0.00	1.155	1.021	7.3	<0.05	<0.1																				
19	1.40	1.459	1.256	7.3	<0.05	<0.1	227	8.8	92			231	21.1	221												
20	1.60	1.552	1.342	7.3	<0.05	0.2																				
21	0.17	1.436	1.204	7.4	<0.05	0.1	161	8.9	89			193	19.5	196												
22	0.02	1.361	1.200	7.4	<0.05	<0.1																				
23	0.01	1.336	1.144	7.3	<0.05	0.1			8.3			80.6														
24	0.02	1.305	1.116	7.2	<0.05	0.1	188	9.6	89	239	21.7	202														
25	0.05	1.239	1.086	7.4	<0.05	<0.1																				
26	0.08	1.266	1.118	7.3	<0.05	<0.1	191	9.0	84			217	25.8	241												
27	0.07	1.287	1.128	7.3	<0.05	<0.1																				
28	0.01	1.269	1.071	7.3	<0.05	<0.1	196	10.2	91			240	22.6	202												
29	0.60	1.243	1.107	7.3	<0.05	<0.1																				
30	0.01	1.401	1.252	7.4	<0.05	<0.1			9.6			88.1		23.4												
31	0.00	1.299	1.114	7.3	<0.05	<0.1	199	12.9	120			226	21.0	195												
TOTAL	4.97	41.79	35.95																							

(MEDIAN)																											
AVG	0.16	1.348	1.160	7.3	<0.05	<0.1	191	8.5	81		215	19.6	187		4.5	8.0	8.0	AVG	0.12	1.160	22.9	11.9	0.012	12.0	0.011	11.0	<5.0
MIN	0.00	1.154	0.989	7.0	<0.05	<0.1	153	4.5	48		168	14.7	147		<1.8	3.9		MIN	0.00	0.989	19.7	9.8	0.012	12.0	0.011	11.0	<5.0
MAX	1.60	1.780	1.460	7.5	<0.05	0.2	246	12.9	120		252	25.8	241		13	10.4		MAX	1.60	1.460	29.3	16.4	0.012	12.0	0.011	11.0	<5.0

DISCHARGE LIMITS:

INSTANT MAX. 1.8 3 225

DAILY MAX. 0.24 0.2

7 DAY AVG. 45 700 45 100

30 DAY AVG. 0.1 30 465 30 14 75

DAILY MAX. OF 10% pH 6.09.0

SIX MONTH MEDIAN 0.06

TSS 85% REMOVAL BOD 75% REMOVAL

ND = NON DETECTED **NA = NOT ANALYZED**

ANALYTE	METHOD USED	METHOD USED	PQL
TOTAL COPPER	EPA 200.7	EPA 200.7	0.020
TOTAL ZINC	EPA 200.7	EPA 200.7	0.050
GREASE & OIL	EPA 1664	EPA 1664	5.0
CHLOROFORM	EPA 624	EPA 624	0.50

42.31 TOTAL RAINFALL (year-to-date)

CALCULATED % REMOVALS
TSS 95.54 BOD 90.87

CITY OF CRESCENT CITY WPCF - SUMMARY OF TREATMENT REPORT
DISCHARGE MONITORING - PERMIT No. CA0022756
ORDER # R1-2011-0019 ID # 1A84006ODN

CITY OF CRESCENT CITY WPCF - SUMMARY OF TREATMENT REPORT
DISCHARGE MONITORING - PERMIT No. CA0022756
ORDER # R1-2011-0019 ID # 1A84006ODN

JAN 2018

ALL SAMPLES ARE FROM MONITORING LOCATION EFF-001 WITH EXCEPTION OF THE THREE IN BOLD MARKED INF

Page 1

JAN 2018

ALL SAMPLES ARE FROM MONITORING LOCATION EFF-001 WITH EXCEPTION OF THE THREE IN BOLD MARKED INF

Page 2

DAY	DAILY REQUIREMENTS						WEEKLY REQUIREMENTS										DAY	RAIN IN	FLOW MGD	INF TOTAL AMMONIA mg/L	ONE SAMPLE PER MONTH REQUIRED						
	RAIN IN	INF FLOW MGD	FLOW MGD	pH	TOTAL CL ₂ mg/L	SETTLE SOLIDS EFF	INF mg/L	EFF mg/L	LBS/DAY	BOD 5 INF mg/L	EFF mg/L	LBS/DAY	FECAL MPN	TURB NTU	TOTAL AMMONIA mg/L	TOTAL COPPER mg/L					TOTAL COPPER ug/L	TOTAL NICKEL mg/L	TOTAL NICKEL ug/L	GREASE & OIL mg/L			
1	0.01	1.265	1.089	7.3	<0.05	<0.1							220	8.1		1	0.01	1.089									
2	0.01	1.245	1.065	7.4	<0.05	<0.1	251	9.2	82				295	21.9	195		2	0.01	1.065								
3	0.11	1.258	1.091	7.4	<0.05	<0.1							17	9.5			3	0.11	1.091								
4	0.83	1.266	1.141	7.4	<0.05	<0.1	189	9.4	89				202	18.1	172		4	0.83	1.141	22.9	10.6						
5	0.08	1.480	1.300	7.4	<0.05	<0.1								9.0			5	0.08	1.300								
6	0.00	1.384	1.169	7.3	<0.05	<0.1			9.3		85.6				20.0	183.4	4.5	6.8	9.0	6	0.00	1.169					
7	0.03	1.351	1.136	7.2	<0.05	<0.1	179	13.5	128				242	21.1	200		7	0.03	1.136	21.3	10.4						
8	1.20	1.495	1.242	7.5	<0.05	<0.1								11.2		2	11.2		8	1.20	1.242						
9	0.22	1.823	1.570	7.4	<0.05	<0.1	236	11.7	153				230	24.7	323		9	0.22	1.570								
10	0.33	1.678	1.456	7.5	<0.05	<0.1								6.3			10	0.33	1.456								
11	0.49	1.804	1.526	7.5	<0.05	<0.1	283	9.7	123				349	17.8	227		11	0.49	1.526	14.7	9.8						
12	0.02	1.679	1.442	7.5	<0.05	<0.1								6.2			12	0.02	1.442								
13	0.00	1.609	1.372	7.4	<0.05	<0.1			11.6		134.9				21.2	250.0	4.0	5.5	7.1	13	0.00	1.372					
14	0.01	1.483	1.282	7.3	<0.05	<0.1	200	9.6	103				209	18.8	201		14	0.01	1.282	16.9	10.4						
15	0.87	1.700	1.451	7.5	<0.05	<0.1								7.2		6.8	7.2		15	0.87	1.451						
16	0.00	1.702	1.471	7.3	<0.05	<0.1	193	10.6	130				186	20.4	250		16	0.00	1.471			0.012	12.0	0.011	11.0	<5.0	
17	1.28	1.699	1.335	7.3	<0.05	<0.1								5.2			17	1.28	1.335								
18	0.74	2.382	1.995	7.3	<0.05	<0.1	290	7.9	131				159	15.0	250		18	0.74	1.995	14.6	7.6						
19	0.36	2.312	1.844	7.4	<0.05	<0.1								4.8			19	0.36	1.844								
20	0.04	2.112	1.778	7.2	<0.05	<0.1			9.4		121.4				18.1	233.6	4.5	4.7	5.8	20	0.04	1.778					
21	1.20	2.439	2.019	7.3	<0.05	<0.1	200	7.6	128				219	13.5	227		21	1.20	2.019	14.8	9.5						
22	0.01	1.900	1.961	7.3	<0.05	<0.1								5.4		8	5.4		22	0.01	1.961						
23	1.96	2.159	1.795	7.3	<0.05	<0.1	178	8.1	121				84	14.1	211		23	1.96	1.795								
24	1.23	3.758	3.068	7.2	<0.05	<0.1								10.5			24	1.23	3.068								
25	0.62	3.595	2.958	7.3	<0.05	<0.1	76	9.3	229				80	15.3	377		25	0.62	2.958								
26	0.33	3.131	2.625	7.3	<0.05	<0.1								4.3			26	0.33	2.625	8.0	4.9						
27	0.10	2.869	2.377	7.3	<0.05	<0.1			8.3		159.6				14.3	271.9	4.5	4.1	5.5	27	0.10	2.377					
28	0.01	2.613	2.151	7.3	<0.05	<0.1	83	6.7	120					4.1			28	0.01	2.151	10.1	4.6						
29	0.26	2.361	2.078	7.3	<0.05	<0.1								4.8		4.5	4.8		29	0.26	2.078						
30	0.01	2.368	1.959	7.3	<0.05	<0.1	114	6.2	101				127	12	191		30	0.01	1.959								
31	0.00	2.190	1.871	7.3	<0.05	<0.1								4.8			31	0.00	1.871								
TOTAL	12.36	62.11	52.62														TOTAL	12.00	52.62								

	AVG	MIN	MAX	RAIN IN	INF FLOW MGD	FLOW MGD	pH	TOTAL CL ₂ mg/L	SETTLE SOLIDS EFF	INF mg/L	EFF mg/L	LBS/DAY	BOD 5 INF mg/L	EFF mg/L	LBS/DAY	FECAL MPN	TURB NTU	DAY	RAIN IN	FLOW MGD	INF TOTAL AMMONIA mg/L	TOTAL AMMONIA mg/L	TOTAL COPPER mg/L	TOTAL COPPER ug/L	TOTAL NICKEL mg/L	TOTAL NICKEL ug/L	GREASE & OIL mg/L	
(MEDIAN)	0.40	0.00	1.96	0.40	2.004	1.697	7.3	<0.05	<0.1	190	9.2	126	199	17.7	235	4.5	6.5	7.1	AVG	0.39	1.697	15.4	8.5	0.012	12.0	0.011	11.0	<5.0
	0.00	0.00	3.758	0.00	1.245	1.065	7.2	<0.05	<0.1	76	6.2	82	80	11.7	172	2	4.1		MIN	0.00	1.065	8.0	4.6	0.012	12.0	0.011	11.0	<5.0
	1.96	1.96	3.758	1.96	3.758	3.068	7.5	<0.05	<0.1	290	13.5	229	349	24.7	377	220	11.2		MAX	1.96	3.068	22.9	10.6	0.012	12.0	0.011	11.0	<5.0

DISCHARGE LIMITS:
INSTANT MAX. 1.8 3 225
DAILY MAX. 0.24 0.2
7 DAY AVG. 45 700 45 100
30 DAY AVG. 0.1 30 465 30 75
DAILY MAX. OF 10% pH 6.09.0
SIX MONTH MEDIAN 0.06
TSS 85% REMOVAL CALCULATED % REMOVALS BOD 75% REMOVAL

ANALYTE	METHOD USED	METHOD USED	PQL
TOTAL COPPER	EPA 200.7	EPA 200.7	0.020
TOTAL ZINC	EPA 200.7	EPA 200.7	0.050
GREASE & OIL	EPA 1664	EPA 1664	5.0
CHLOROFORM	EPA 624	EPA 624	0.50

42.31 TOTAL RAINFALL (year-to-date) TSS **95.17** BOD **91.08**

CITY OF CRESCENT CITY WPCF - SUMMARY OF TREATMENT REPORT
DISCHARGE MONITORING - PERMIT No. CA0022756
ORDER # R1-2011-0019 ID # 1A84006ODN

CITY OF CRESCENT CITY WPCF - SUMMARY OF TREATMENT REPORT
DISCHARGE MONITORING - PERMIT No. CA0022756
ORDER # R1-2011-0019 ID # 1A84006ODN

FEB 2018

ALL SAMPLES ARE FROM MONITORING LOCATION EFF-001 WITH EXCEPTION OF THE THREE IN BOLD MARKED INF

Page 1

FEB 2018

ALL SAMPLES ARE FROM MONITORING LOCATION EFF-001 WITH EXCEPTION OF THE THREE IN BOLD MARKED INF

Page 2

DAY	DAILY REQUIREMENTS							WEEKLY REQUIREMENTS							DAY	RAIN IN	FLOW MGD	INF TOTAL AMMONIA mg/L	ONE SAMPLE PER MONTH REQUIRED					GREASE & OIL mg/L
	RAIN IN	INF FLOW MGD	FLOW MGD	pH	TOTAL CL ₂ mg/L	SETTLE SOLIDS EFF	SUSPENDED SOLIDS			BOD 5			FECAL MPN	TURB NTU					TOTAL AMMONIA mg/L	TOTAL COPPER mg/L	TOTAL COPPER ug/L	TOTAL NICKEL mg/L	TOTAL NICKEL ug/L	
							INF mg/L	EFF mg/L	LBS/DAY	INF mg/L	EFF mg/L	LBS/DAY												
1	0.00	2.072	1.745	7.3	<0.05	<0.1	160	6.6	96	104	11.0	160	4.3	1	0.00	1.745	15.0	10						
2	0.00	1.935	1.716	7.4	<0.05	<0.1							4.4	2	0.00	1.716								
3	0.01	1.884	1.581	7.4	<0.05	<0.1							4.5	3	0.01	1.581								
4	0.00	1.846	1.535	7.4	<0.05	<0.1	143	8.6	110	152	13.2	169	4.8	4	0.00	1.535	17.0	7.6						
5	0.00	1.741	1.496	7.3	<0.05	<0.1							5.8	5	0.00	1.496								
6	0.00	1.731	1.460	7.3	<0.05	0.1	171	6.5	79	171	13.5	164	5.8	6	0.00	1.460								
7	0.00	1.697	1.437	7.5	<0.05	0.1							5.8	7	0.00	1.437								
8	0.00	1.676	1.421	7.4	<0.05	0.1	176	8.8	104	187	12.8	152	9.3	8	0.00	1.421	21.9	9.0						
9	0.00	1.614	1.474	7.3	<0.05	<0.1							5.6	9	0.00	1.474								
10	0.00	1.590	1.348	7.3	<0.05	<0.1		8.0	97.8		13.2	161.7	2	5.9	10	0.00	1.348							
11	0.12	1.717	1.361	7.3	<0.05	<0.1	153	5.4	61	212	12.8	145	3.9	11	0.12	1.361	23.5	9.5						
12	0.01	1.504	1.320	7.4	<0.05	<0.1							6.5	12	0.01	1.320								
13	0.00	1.480	1.250	7.3	<0.05	0.1	163	7.2	75	196	13.3	139	4.9	13	0.00	1.250			0.017	17	0.015	15	<5.0	
14	0.07	1.469	1.306	7.3	<0.05	0.1							6.6	14	0.07	1.306								
15	0.01	1.405	1.202	7.3	<0.05	0.1	165	7.7	77	207	14.7	147	6.3	15	0.01	1.202	24.5	11.3						
16	0.00	1.404	1.237	7.3	<0.05	0.1							6.1	16	0.00	1.237								
17	0.27	1.400	1.266	7.2	<0.05	<0.1		6.8	71.2		13.6	143.8	13.0	5.6	17	0.27	1.266							
18	0.42	1.522	1.324	7.2	<0.05	<0.1	173	7.7	85	216	12.8	141	4.3	18	0.42	1.324	22.3	11.2						
19	0.00	1.514	1.324	7.2	<0.05	<0.1							4.7	19	0.00	1.324								
20	0.08	1.465	1.273	7.2	<0.05	<0.1	196	8.4	89	213	13.8	147	5.0	20	0.08	1.273								
21	0.25	1.440	1.286	7.3	<0.05	0.1							12.8	21	0.25	1.286								
22	0.05	1.485	1.286	7.3	<0.05	<0.1	228	10.0	107	217	18.1	194	6.4	22	0.05	1.286	23.8	13						
23	0.11	1.398	1.196	7.4	<0.05	<0.1							6.4	23	0.11	1.196								
24	0.21	1.494	1.318	7.3	<0.05	<0.1		8.7	93.8		14.9	160.7	3.9	6.2	24	0.21	1.318							
25	0.88	1.569	1.356	7.2	<0.05	<0.1	181	8.9	101	176	14.2	161	3.8	25	0.88	1.356	22.2	12.6						
26	0.01	1.729	1.482	7.4	<0.05	<0.1							6.6	26	0.01	1.482								
27	0.00	1.602	1.378	7.3	<0.05	0.1	143	9.3	107	159	13.1	151	5.6	27	0.00	1.378								
28	1.65	1.792	1.415	7.3	<0.05	<0.1							6.6	28	1.65	1.415								
TOTAL	4.15	45.18	38.79											TOTAL	4.15	38.79								

	AVG	MIN	MAX	DISCHARGE LIMITS:	INSTANT MAX.	DAILY MAX.	7 DAY AVG.	30 DAY AVG.	DAILY MAX. OF 10%	pH	SIX MONTH MEDIAN
RAIN	0.15	0.00	1.65	1.6	2.072	1.745	1.745	1.745	2.072	7.3	6.09.0
INF FLOW	1.613	1.398	1.745	3	2.072	1.745	1.745	1.745	2.072		
FLOW	1.385	1.196	1.415	0.24	1.745	1.415	1.415	1.415	1.745		
pH	7.3	7.2	7.5	0.1	7.4	7.3	7.3	7.3	7.3		
TOTAL CL ₂	<0.05	<0.05	<0.05	0.1	<0.1	<0.1	<0.1	<0.1	<0.1		
SETTLE SOLIDS	<0.1	<0.1	<0.1	0.1	<0.1	<0.1	<0.1	<0.1	<0.1		
INF	171	143	228	45	228	228	228	228	228		
EFF	6.5	6.6	10.0	700	10.0	10.0	10.0	10.0	10.0		
LBS/DAY	79	110	110	465	110	110	110	110	110		
BOD 5	12.8	11.0	18.1	45	18.1	18.1	18.1	18.1	18.1		
INF	104	104	194	100	194	194	194	194	194		
EFF	11.0	11.0	12.8	100	12.8	12.8	12.8	12.8	12.8		
LBS/DAY	160	160	194	43	194	194	194	194	194		
FECAL	4.3	4.4	4.5	225	4.5	4.5	4.5	4.5	4.5		
TURB	4.3	4.4	4.7	225	4.7	4.7	4.7	4.7	4.7		
INF	15.0	15.0	24.5	NA	24.5	24.5	24.5	24.5	24.5		
TOTAL AMMONIA	10	9.0	13.0	NA	13.0	13.0	13.0	13.0	13.0		
TOTAL COPPER	7.6	9.0	11.3	NA	11.3	11.3	11.3	11.3	11.3		
TOTAL COPPER ug/L				NA							
TOTAL NICKEL			0.015	NA	0.015	0.015	0.015	0.015	0.015		
TOTAL NICKEL ug/L			15	NA	15	15	15	15	15		
GREASE & OIL			<5.0	NA	<5.0	<5.0	<5.0	<5.0	<5.0		

	AVG	MIN	MAX	DISCHARGE LIMITS:	INSTANT MAX.	DAILY MAX.	7 DAY AVG.	30 DAY AVG.	DAILY MAX. OF 10%	pH	SIX MONTH MEDIAN
RAIN	0.15	0.00	1.65	1.6	2.072	1.745	1.745	1.745	2.072	7.3	6.09.0
INF FLOW	1.613	1.398	1.745	3	2.072	1.745	1.745	1.745	2.072		
FLOW	1.385	1.196	1.415	0.24	1.745	1.415	1.415	1.415	1.745		
pH	7.3	7.2	7.5	0.1	7.4	7.3	7.3	7.3	7.3		
TOTAL CL ₂	<0.05	<0.05	<0.05	0.1	<0.1	<0.1	<0.1	<0.1	<0.1		
SETTLE SOLIDS	<0.1	<0.1	<0.1	0.1	<0.1	<0.1	<0.1	<0.1	<0.1		
INF	171	143	228	45	228	228	228	228	228		
EFF	6.5	6.6	10.0	700	10.0	10.0	10.0	10.0	10.0		
LBS/DAY	79	110	110	465	110	110	110	110	110		
BOD 5	12.8	11.0	18.1	45	18.1	18.1	18.1	18.1	18.1		
INF	104	104	194	100	194	194	194	194	194		
EFF	11.0	11.0	12.8	100	12.8	12.8	12.8	12.8	12.8		
LBS/DAY	160	160	194	43	194	194	194	194	194		
FECAL	4.3	4.4	4.5	225	4.5	4.5	4.5	4.5	4.5		
TURB	4.3	4.4	4.7	225	4.7	4.7	4.7	4.7	4.7		
INF	15.0	15.0	24.5	NA	24.5	24.5	24.5	24.5	24.5		
TOTAL AMMONIA	10	9.0	13.0	NA	13.0	13.0	13.0	13.0	13.0		
TOTAL COPPER	7.6	9.0	11.3	NA	11.3	11.3	11.3	11.3	11.3		
TOTAL COPPER ug/L				NA							
TOTAL NICKEL			0.015	NA	0.015	0.015	0.015	0.015	0.015		
TOTAL NICKEL ug/L			15	NA	15	15	15	15	15		
GREASE & OIL			<5.0	NA	<5.0	<5.0	<5.0	<5.0	<5.0		

ANALYTE	METHOD USED	METHOD USED	PQL
TOTAL COPPER	EPA 200.7	EPA 200.7	0.020
TOTAL ZINC	EPA 200.7	EPA 200.7	0.050
GREASE & OIL	EPA 1664	EPA 1664	5.0
CHLOROFORM	EPA 624	EPA 624	0.50

42.31 TOTAL RAINFALL (year-to-date)

TSS 95.37 CALCULATED % REMOVALS BOD 92.61

CITY OF CRESCENT CITY WPCF - SUMMARY OF TREATMENT REPORT
 DISCHARGE MONITORING - PERMIT No. CA0022756
 ORDER # R1-2011-0019 ID # 1A84006ODN

CITY OF CRESCENT CITY WPCF - SUMMARY OF TREATMENT REPORT
 DISCHARGE MONITORING - PERMIT No. CA0022756
 ORDER # R1-2011-0019 ID # 1A84006ODN

MAR 2018

ALL SAMPLES ARE FROM MONITORING LOCATION EFF-001 WITH EXCEPTION OF THE THREE IN BOLD MARKED INF

Page 1

MAR 2018

ALL SAMPLES ARE FROM MONITORING LOCATION EFF-001 WITH EXCEPTION OF THE THREE IN BOLD MARKED INF

Page 2

DAY	DAILY REQUIREMENTS										WEEKLY REQUIREMENTS						DAY	RAIN IN	FLOW MGD	INF TOTAL AMMONIA mg/L	ONE SAMPLE PER MONTH REQUIRED				
	RAIN IN	INF FLOW MGD	FLOW MGD	pH	TOTAL CL ₂ mg/L	SETTLE SOLIDS EFF	INF mg/L	EFF mg/L	LBS/DAY	BOD 5 INF mg/L	BOD 5 EFF mg/L	LBS/DAY	FECAL MPN	TURB NTU	TOTAL AMMONIA mg/L	TOTAL COPPER mg/L					TOTAL COPPER ug/L	TOTAL NICKEL mg/L	TOTAL NICKEL ug/L	GREASE & OIL mg/L	
1	0.95	2.613	2.193	7.2	<0.05	<0.1	164	8.7		159		155	14.4		263		7.4								
2	0.68	2.687	2.251	7.3	<0.05	<0.1											5.5								
3	0.53	2.662	2.248	7.3	<0.05	0.1								4.5	4.9										
4	0.15	2.473	2.157	7.3	<0.05	2.0	128	10.2		183		143	16.1		290		5.4		12.8	7.6					
5	0.01	2.102	1.895	7.4	<0.05	<0.1								2	6.0										
6	0.00	1.988	1.793	7.2	<0.05	<0.1	163	7.2		108		126	12.1		181		4.6								
7	0.57	1.954	1.803	7.2	<0.05	<0.1								2	5.7										
8	0.92	1.106	1.881	7.3	<0.05	<0.1	164	7.2	8.2	113	134.7	145	11.7	13.3	184	218.0	6.1								
9	0.02	2.380	2.169	7.2	<0.05	<0.1											6.4								
10	0.05	2.133	1.921	7.2	<0.05	<0.1								2	4.3	5.5									
11	0.00	1.993	1.800	7.2	<0.05	<0.1	107	8.2		123		128	12.8		192		4.8		13.9	4.7					
12	1.41	1.885	1.711	7.2	<0.05	0.1								4.5	5.8										
13	0.59	2.744	2.454	7.2	<0.05	<0.1	157	8.1		166		137	13.3		272		7.7								
14	0.47	2.532	2.378	7.2	<0.05	<0.1											6.3								
15	1.91	3.093	2.839	7.3	<0.05	0.1	96	9.0	8.4	213	167.3	99.6	14.6	13.6	346	270.0	4.5	4.7	9.8	6.0					
16	0.58	3.739	3.279	7.3	<0.05	0.1											9.0								
17	0.01	3.169	2.626	7.2	<0.05	<0.1								2	3.8	6.0									
18	0.01	2.749	2.264	7.3	<0.05	<0.1	88	8.6		162		146	58.6		1106		4.1								
19	0.00	2.500	2.051	7.3	<0.05	0.1								<1.8	4.7										
20	0.18	1.995	2.358	7.2	<0.05	<0.1	99.6	7.4		146		117	14.9		293		4.9		0.010	9.8	0.015	15.0	<5.0		
21	2.35	2.335	1.946	7.1	<0.05	<0.1								<1.8	5.5										
22	1.08	3.790	3.396	7.0	<0.05	<0.1	159	7.6	7.9	215	174.4	122	15.6	29.7	442	613.8	12.2		11.7	4.8					
23	1.03	4.223	3.729	7.1	<0.05	<0.1											5.0								
24	0.92	4.060	3.667	7.2	<0.05	<0.1								4.5	4.1	5.8									
25	0.02	3.776	3.204	7.3	<0.05	<0.1	77.9	10.4		278		69.8	16.9		6.6		3.9								
26	0.00	3.097	2.702	7.2	<0.05	<0.1								2	6.4										
27	0.00	2.773	2.507	7.3	<0.05	<0.1	81.0	10.9		228		90.2	20.0		418		4.8								
28	0.00	2.575	2.279	7.3	<0.05	<0.1											4.3								
29	0.00	2.412	2.111	7.0	<0.05	<0.1	96.6	6.6	9.3	116	207.3	111	13.8	16.9	243	222.6	4.5		13.9	8					
30	0.00	2.235	2.022	7.2	<0.05	<0.1											4.4								
31	0.00	2.153	1.881	7.2	<0.05	<0.1											4.5	4.7							
TOTAL	14.44	81.93	73.52																						

	AVG	MIN	MAX	RAIN IN	INF FLOW MGD	FLOW MGD	pH	TOTAL CL ₂ mg/L	SETTLE SOLIDS EFF	INF mg/L	EFF mg/L	LBS/DAY	BOD 5 INF mg/L	BOD 5 EFF mg/L	LBS/DAY	FECAL MPN	TURB NTU	DAY	RAIN IN	FLOW MGD	INF TOTAL AMMONIA mg/L	TOTAL AMMONIA mg/L	TOTAL COPPER mg/L	TOTAL COPPER ug/L	TOTAL NICKEL mg/L	TOTAL NICKEL ug/L	GREASE & OIL mg/L
(MEDIAN)	0.47	0.00	2.35	0.47	2.643	2.371	7.2	<0.05	0.4	122	8.5	170	122	18.1	326	2	5.5	6.0	0.47	2.371	12.3	6.2	0.010	9.8	0.015	15.0	<5.0
AVG	0.47	0.00	2.35	0.47	2.643	2.371	7.2	<0.05	0.4	122	8.5	170	122	18.1	326	2	5.5	6.0	0.47	2.371	12.3	6.2	0.010	9.8	0.015	15.0	<5.0
MIN	0.00	0.00	2.35	0.00	1.106	1.711	7.0	<0.05	<0.1	78	6.6	108	70	11.7	7	<1.8	3.8		0.00	1.711	6.6	3.9	0.010	9.8	0.015	15.0	<5.0
MAX	2.35	4.223	3.729	7.4	<0.05	2.0	164	10.9		164	10.9	278	155	58.6	1106	5	12.2		2.35	3.729	16.1	8.7	0.010	9.8	0.015	15.0	<5.0

DISCHARGE LIMITS:

INSTANT MAX. 1.8 3 225

DAILY MAX. 0.24 0.2

7 DAY AVG. 45 700 45 100

30 DAY AVG. 0.1 30 465 30 75

DAILY MAX. OF 10% pH 6.09.0

SIX MONTH MEDIAN 0.06

TSS 85% REMOVAL CALCULATED % REMOVALS BOD 75% REMOVAL

ND = NON DETECTED

NA = NOT ANALYZED

ANALYTE	METHOD USED	METHOD USED	PQL
TOTAL COPPER	EPA 200.7	EPA 200.7	0.020
TOTAL ZINC	EPA 200.7	EPA 200.7	0.050
GREASE & OIL	EPA 1664	EPA 1664	5.0
CHLOROFORM	EPA 624	EPA 624	0.50

42.31 TOTAL RAINFALL (year-to-date) TSS 93.04 BOD 85.23

CITY OF CRESCENT CITY WPCF - SUMMARY OF TREATMENT REPORT

DISCHARGE MONITORING - PERMIT No. CA0022756
 ORDER # R1-2011-0019 ID # 1A84006ODN

CITY OF CRESCENT CITY WPCF - SUMMARY OF TREATMENT REPORT

DISCHARGE MONITORING - PERMIT No. CA0022756
 ORDER # R1-2011-0019 ID # 1A84006ODN

APR 2018

ALL SAMPLES ARE FROM MONITORING LOCATION EFF-001 WITH EXCEPTION OF THE THREE IN BOLD MARKED INF

Page 1

APR 2018

ALL SAMPLES ARE FROM MONITORING LOCATION EFF-001 WITH EXCEPTION OF THE THREE IN BOLD MARKED INF

Page 2

DAY	DAILY REQUIREMENTS						WEEKLY REQUIREMENTS										DAY	FLOW MGD	ONE SAMPLE PER MONTH REQUIRED					
	RAIN IN	INF FLOW MGD	FLOW MGD	pH	TOTAL CL ₂ mg/L	SETTLE SOLIDS EFF	SUSPENDED SOLIDS			BOD 5			FECAL MPN	TURB NTU	INF TOTAL AMMONIA mg/L	TOTAL AMMONIA mg/L			TOTAL COPPER mg/L	TOTAL COPPER ug/L	TOTAL NICKEL mg/L	TOTAL NICKEL ug/L	GREASE & OIL mg/L	
						INF mg/L	EFF mg/L	LBS/DAY		INF mg/L	EFF mg/L	LBS/DAY												
1	0.12	2.015	1.736	7.3	<0.05	<0.1	113	6.5	94	132	16.3	236			2	6.1	1	1.736	15.2	5.9				
2	0.00	1.973	1.748	7.3	<0.05	<0.1									2	5.8	2	1.748						
3	0.00	1.906	1.633	7.3	<0.05	<0.1				131	16.6	226			2	5.9	3	1.633		0.012	12.0	0.016	16	<5.0
4	0.00	1.848	1.632	7.2	<0.05	<0.1									2	6.7	4	1.632						
5	1.48	1.934	1.727	7.3	<0.05	<0.1	147	8.0	115	132	16.2	233				5.4	5	1.727	16.3	9				
6	0.50	2.363	2.123	7.2	<0.05	<0.1										5.5	6	2.123						
7	0.12	2.310	2.042	7.2	<0.05	<0.1		7.3	104.7			16.4		231.8	2	5.0	7	2.042						
8	0.03	2.113	1.864	7.4	<0.05	<0.1	88	7.7	120	121	16.2	252				5.5	8	1.864	13.8	5.5				
9	0.50	1.993	1.792	7.3	<0.05	<0.1								6.8	5.5		9	1.792						
10	0.02	2.121	1.879	7.4	<0.05	<0.1				130	16.8	263				5.5	10	1.879						
11	0.78	2.198	1.948	7.4	<0.05	<0.1										5.3	11	1.948						
12	0.10	2.280	2.006	7.4	<0.05	<0.1	107	10.0	167	93.3	17.8	298		<1.8	4.2		12	2.006	12.5	6.3				
13	0.05	2.090	1.877	7.4	<0.05	<0.1										5.0	13	1.877						
14	0.07	1.988	1.736	7.2	<0.05	<0.1		8.9	143.5			16.9	271.0	<1.8	5.4	5.2	14	1.736						
15	1.14	2.371	2.106	7.3	<0.05	0.1	115	7.0	123	135	16.5	290				5.1	15	2.106	13.8	5.6				
16	0.02	2.342	2.054	7.3	<0.05	<0.1									2	5.4	16	2.054						
17	0.01	2.150	1.914	7.3	<0.05	<0.1	107	7.1	113	121	15.5	247				4.6	17	1.914						
18	0.00	2.044	1.794	7.3	<0.05	<0.1								2	6.0		18	1.794						
19	0.00	1.928	1.680	7.3	<0.05	<0.1	104	6.7	94	126	15.4	216				4.5	19	1.680	13.6	6.7				
20	0.00	1.821	1.712	7.3	<0.05	0.1										6.9	20	1.712						
21	0.00	1.778	1.564	7.1	<0.05	<0.1		6.9	110.1			15.8	251.0	4.5	4.4	5.3	21	1.564						
22	0.00	1.760	1.549	7.2	<0.05	<0.1	137	9.4	121	155	17.1	221				4.2	22	1.549	15.9	6.0				
23	0.00	1.672	1.495	7.4	<0.05	0.1								13	6.4		23	1.495						
24	0.00	1.644	1.495	7.2	<0.05	<0.1	144	7.8	97	156	16.7	208				5.3	24	1.495						
25	0.01	1.602	1.417	7.5	<0.05	0.1								<1.8	5.9		25	1.417						
26	0.01	1.554	1.414	7.3	<0.05	<0.1	158	6.8	80	96.6	16.0	189				5.7	26	1.414	18.0	6.9				
27	0.35	1.536	1.396	7.3	<0.05	<0.1										6.8	27	1.396						
28	0.25	1.580	1.447	7.3	<0.05	<0.1		8.0	99.6			16.6	205.9			6.2	28	1.447						
29	0.05	1.562	1.390	7.2	<0.05	<0.1	153	9.0	104	186	18.2	211				6.1	29	1.390	17.5	8.9				
30	0.01	1.488	1.376	7.3	<0.05	<0.1								4.5	8.7		30	1.376						
TOTAL	5.62	57.96	51.55														TOTAL	51.55						

(MEDIAN)

AVG	0.19	1.932	1.718	7.3	<0.05	<0.1	125	7.8	112	132	16.6	238		2	5.6	5.8	AVG	1.718	15.2	6.8	0.012	12.0	0.016	16.0	<5.0
MIN	0.00	1.488	1.376	7.1	<0.05	0.1	88	6.5	80	93	15.4	189		<1.8	4.2		MIN	1.376	12.5	5.5	0.012	12.0	0.016	16.0	<5.0
MAX	1.48	2.371	2.123	7.5	<0.05	<0.1	158	10.0	167	186	18.2	298		13	8.7		MAX	2.123	18.0	9.0	0.012	12.0	0.016	16.0	<5.0

DISCHARGE LIMITS:

INSTANT MAX.	1.8	3													225	
DAILY MAX.	0.24	0.2														
7 DAY AVG.							45	700			45				100	
30 DAY AVG.						0.1	30	465			30				75	
DAILY MAX. OF 10% pH	6.0/9.0													43		
SIX MONTH MEDIAN				0.06												

ND = NON DETECTED

NA = NOT ANALYZED

ANALYTE	METHOD USED	METHOD USED	PQL
TOTAL COPPER	EPA 200.7	EPA 200.7	0.020
TOTAL ZINC	EPA 200.7	EPA 200.7	0.050
GREASE & OIL	EPA 1664	EPA 1664	5.0
CHLOROFORM	EPA 624	EPA 624	0.50

42.31 TOTAL RAINFALL (year-to-date)

TSS 93.74 BOD 87.45

CITY OF CRESCENT CITY WPCF - SUMMARY OF TREATMENT REPORT

DISCHARGE MONITORING - PERMIT No. CA0022756
ORDER # R1-2011-0019 ID # 1A84006ODN

CITY OF CRESCENT CITY WPCF - SUMMARY OF TREATMENT REPORT

DISCHARGE MONITORING - PERMIT No. CA0022756
ORDER # R1-2011-0019 ID # 1A84006ODN

MAY 2018

ALL SAMPLES ARE FROM MONITORING LOCATION EFF-001 WITH EXCEPTION OF THE THREE IN BOLD MARKED INF

Page 1

MAY 2018

ALL SAMPLES ARE FROM MONITORING LOCATION EFF-001 WITH EXCEPTION OF THE THREE IN BOLD MARKED INF

Page 2

DAY	DAILY REQUIREMENTS						WEEKLY REQUIREMENTS										DAY	RAIN IN	FLOW MGD	ONE SAMPLE PER MONTH REQUIRED					GREASE & OIL mg/L				
	RAIN IN	INF FLOW MGD	FLOW MGD	pH	TOTAL CL ₂ mg/L	SETTLE SOLIDS EFF	SUSPENDED SOLIDS			BOD 5			FECAL MPN	TURB NTU	INF TOTAL AMMONIA mg/L	TOTAL AMMONIA mg/L				TOTAL COPPER mg/L	TOTAL COPPER ug/L	TOTAL NICKEL mg/L	TOTAL NICKEL ug/L						
							INF mg/L	EFF mg/L	LBS/DAY	INF mg/L	EFF mg/L	LBS/DAY																	
1	0.00	1.467	1.311	7.3	<0.05	<0.1	163	8.3	91	169	17.5	191	169	17.5	191	8	7.1	6.2	1	0.00	1.311								
2	0.00	1.439	1.290	7.3	<0.05	<0.1										2	0.00	1.290											
3	0.00	1.405	1.270	7.4	<0.05	<0.1	157	8.1	86	107	17.0	180	107	17.0	180	3	0.00	1.270	19.5	10.9									
4	0.00	1.379	1.256	7.4	<0.05	<0.1			8.2			88.3			17.3	185.7	6.7	4	0.00	1.256									
5	0.00	1.373	1.224	7.2	<0.05	<0.1										4.5	5.7	6.5	5	0.00	1.224								
6	0.00	1.378	1.217	7.2	<0.05	<0.1	191	7.8	79	230	18.8	191	230	18.8	191	7	4.3	4.3	6	0.00	1.217	22.9	8.7						
7	0.00	1.309	1.188	7.3	<0.05	<0.1										7	8.0	8.0	7	0.00	1.188								
8	0.29	1.338	1.224	7.3	<0.05	<0.1	137	7.4	76	182	16.0	163	182	16.0	163	4	7.4	7.4	8	0.29	1.224								
9	0.29	1.335	1.210	7.3	<0.05	<0.1										4.5	7.8	7.8	9	0.29	1.210								
10	0.00	1.326	1.175	7.4	<0.05	<0.1	132	10.6	104	111	20.0	196	111	20.0	196	4	7.9	7.9	10	0.00	1.175	24.5	13.1						
11	0.00	1.296	1.181	7.4	<0.05	<0.1			8.6			86.2			18.3	183.4	7.6	11	0.00	1.181									
12	0.00	1.274	1.139	7.3	<0.05	<0.1										4.5	5.9	7.0	12	0.00	1.139								
13	0.00	1.265	1.157	7.2	<0.05	<0.1	156	8.8	85	182	18.1	175	182	18.1	175	4	5.5	5.5	13	0.00	1.157	24.1	9.2						
14	0.00	1.255	1.150	7.3	<0.05	<0.1										350	7.0	7.0	14	0.00	1.150								
15	0.02	1.244	1.119	7.2	<0.05	<0.1	184	6.4	60	225	13.2	123	225	13.2	123	4	3.5	3.5	15	0.02	1.119			0.010	9.8	0.013	13.0	<5.0	
16	0.02	1.243	1.124	7.3	<0.05	0.1											12.5	12.5	16	0.02	1.124								
17	0.01	1.233	1.107	7.3	<0.05	<0.1	227	7.0	65	225	13.5	125	225	13.5	125	4	6.5	6.5	17	0.01	1.107	26.1	9.9						
18	0.00	1.207	1.065	7.3	<0.05	<0.1			7.4			69.8			14.9	140.8	6.5	18	0.00	1.065									
19	0.00	1.215	1.115	7.1	<0.05	<0.1										4	2.1	6.2	19	0.00	1.115								
20	0.00	1.248	1.100	7.0	<0.05	<0.1	169	8.7	80	192	14.5	133	192	14.5	133	4	2.7	2.7	20	0.00	1.100	24.3	10.8						
21	0.00	1.201	1.095	7.2	<0.05	<0.1										4.0	6.4	6.4	21	0.00	1.095								
22	0.00	1.209	1.073	7.1	<0.05	<0.1											4.1	4.1	22	0.00	1.073								
23	0.01	1.203	1.113	7.3	<0.05	<0.1	190	6.0	56	209	8.8	82	209	8.8	82	4	6.0	6.0	23	0.01	1.113								
24	0.00	1.160	1.034	7.3	<0.05	<0.1	194	7.2	62	220	11.9	103	220	11.9	103	4	5.5	5.5	24	0.00	1.034	26.6	11.4						
25	0.04	1.189	1.141	7.4	<0.05	<0.1			7.3			65.9			11.7	105.8	6.6	25	0.04	1.141									
26	0.39	1.184	1.058	7.2	<0.05	<0.1										22	4.2	5.1	26	0.39	1.058								
27	0.00	1.144	1.030	7.1	<0.05	<0.1	148	7.1	61	203	13.2	113	203	13.2	113	4	2.7	2.7	27	0.00	1.030	25.3	9.3						
28	0.00	1.194	1.106	7.2	<0.05	<0.1										2	4.2	4.2	28	0.00	1.106								
29	0.00	1.154	1.044	7.2	<0.05	<0.1	283	7.7	67	402	14.9	130	402	14.9	130	4	3.7	3.7	29	0.00	1.044								
30	0.00	1.137	1.050	7.2	<0.05	<0.1											3.7	3.7	30	0.00	1.050								
31	0.00	1.128	0.997	7.3	<0.05	<0.1	147		7.4			64.0	194	8.9	12.3	74	105.7	3.9	4.1	31	0.00	0.997	26.4						
TOTAL	1.07	39.13	35.36																TOTAL	1.07	35.36								

(MEDIAN)

AVG	0.03	1.262	1.141	7.3	<0.05	<0.1	177	7.8	75		204	14.7		141	4.5	5.8	7.0	AVG	0.03	1.141	24.4	10.4	0.010	9.8	0.013	13.0	<5.0
MIN	0.00	1.128	0.997	7.0	<0.05	0.1	132	6.0	56		107	8.8		74	2	2.1		MIN	0.00	0.997	19.5	8.7	0.010	9.8	0.013	13.0	<5.0
MAX	0.39	1.467	1.311	7.4	<0.05	<0.1	283	10.6	104		402	20.0		196	350	12.5		MAX	0.39	1.311	26.6	13.1	0.010	9.8	0.013	13.0	<5.0

DISCHARGE LIMITS:

INSTANT MAX.	1.8	3														225	
DAILY MAX.	0.24	0.2															
7 DAY AVG.							45	700				45				100	
30 DAY AVG.							0.1	30	465			30				75	
DAILY MAX. OF 10% pH	6.09.0															43	
SIX MONTH MEDIAN		0.06															
TSS 85% REMOVAL																	
BOD 75% REMOVAL																	

CALCULATED % REMOVALS

TSS **95.61** BOD **92.76**

ND = NON DETECTED **NA = NOT ANALYZED**

ANALYTE	METHOD USED	METHOD USED	PQL
TOTAL COPPER	EPA 200.7	EPA 200.7	0.020
TOTAL ZINC	EPA 200.7	EPA 200.7	0.050
GREASE & OIL	EPA 1664	EPA 1664	5.0
CHLOROFORM	EPA 624	EPA 624	0.50

42.31 TOTAL RAINFALL (year-to-date)

CITY OF CRESCENT CITY WPCF - SUMMARY OF TREATMENT REPORT
 DISCHARGE MONITORING - PERMIT No. CA0022756
 ORDER # R1-2011-0019 ID # 1A84006ODN

CITY OF CRESCENT CITY WPCF - SUMMARY OF TREATMENT REPORT
 DISCHARGE MONITORING - PERMIT No. CA0022756
 ORDER # R1-2011-0019 ID # 1A84006ODN

JUN 2018

ALL SAMPLES ARE FROM MONITORING LOCATION EFF-001 WITH EXCEPTION OF THE THREE IN BOLD MARKED INF

Page 1

JUN 2018

ALL SAMPLES ARE FROM MONITORING LOCATION EFF-001 WITH EXCEPTION OF THE THREE IN BOLD MARKED INF

Page 2

DAY	DAILY REQUIREMENTS							WEEKLY REQUIREMENTS										DAY	RAIN IN	FLOW MGD	ONE SAMPLE PER MONTH REQUIRED													
	RAIN IN	INF FLOW MGD	FLOW MGD	pH	TOTAL CL ₂ mg/L	SETTLE SOLIDS EFF	INF mg/L	EFF mg/L	LBS/DAY	BOD 5			FECAL MPN	TURB NTU	TOTAL AMMONIA mg/L	TOTAL AMMONIA mg/L	TOTAL COPPER mg/L				TOTAL COPPER ug/L	TOTAL NICKEL mg/L	TOTAL NICKEL ug/L	GREASE & OIL mg/L										
1	0.00	1.094	1.004	7.4	<0.05	<0.1										5.2		1	0.00	1.004	29.0	8.5												
2	0.00	1.091	0.962	7.1	<0.05	0.1										2.6		2	0.00	0.962														
3	0.00	1.116	1.009	7.1	<0.05	<0.1										2.4		3	0.00	1.009														
4	0.00	1.082	0.981	7.3	<0.05	<0.1	256	6.1	50		272	11.6	95		7.8	5.1	4	0.00	0.981	29.4	8.1													
5	0.00	1.092	0.952	7.1	<0.05	0.1	232	5.7	45		249	12.0	95		3.1		5	0.00	0.952															
6	0.00	1.103	1.016	7.4	<0.05	0.1									7.8	5.4	6	0.00	1.016															
7	0.00	1.090	0.960	7.1	<0.05	<0.1	153	8.6	69		213	13.2	106		4.4		7	0.00	0.960	31.4	16.6													
8	0.56	1.094	0.989	7.3	<0.05	<0.1			6.8		54.7			12.3		98.6		8	0.56	0.989														
9	0.21	1.165	1.032	7.3	<0.05	<0.1									11	4.0	4.3	9	0.21	1.032														
10	0.01	1.147	1.001	7.2	<0.05	<0.1	208	7.3	61		239	13.5	113		3.6		10	0.01	1.001	30.2	8.7													
11	0.01	1.131	0.993	7.3	<0.05	<0.1									7.8	3.9	11	0.01	0.993															
12	0.00	1.136	1.059	7.3	<0.05	0.1	193	7.2	64		232	13.4	118		4.4		12	0.00	1.059			0.015	15	0.010	10.0	<5.0								
13	0.00	1.134	1.046	7.3	<0.05	<0.1									13	3.6	13	0.00	1.046															
14	0.00	1.113	1.026	7.2	<0.05	<0.1	283	7.1	61		302	11.4	98		4.6		14	0.00	1.026	30.8	14.9													
15	0.00	1.119	1.023	7.2	<0.05	<0.1		7.2		61.8			12.8		109.5		15	0.00	1.023															
16	0.00	1.097	0.969	7.2	<0.05	0.1									33	2.1	3.7	16	0.00	0.969														
17	0.00	1.093	0.975	7.1	<0.05	0.1	249	7.6	62		285	10.7	87		1.7		17	0.00	0.975	32.1	8.7													
18	0.00	1.090	1.004	7.2	<0.05	<0.1									11	3.8	18	0.00	1.004															
19	0.00	1.090	0.978	7.3	<0.05	0.1	195	9.0	73		271	11.8	96		4.2		19	0.00	0.978															
20	0.00	1.087	1.018	7.1	<0.05	<0.1									6.8	2.5	20	0.00	1.018															
21	0.00	1.072	0.960	7.3	<0.05	<0.1	280	8.0	64		267	11.4	91		3.7		21	0.00	0.960	27.8	12.5													
22	0.00	1.067	0.944	7.3	<0.05	<0.1			8.2		66.4			11.3		91.5		22	0.00	0.944														
23	0.00	1.045	0.976	7.2	<0.05	<0.1									4.5	2.1	3.1	23	0.00	0.976														
24	0.00	1.046	0.913	7.1	<0.05	<0.1	271	8.4	64		292	11.5	88		1.9		24	0.00	0.913	30.8	10.0													
25	0.00	1.065	0.964	7.2	<0.05	<0.1									4.5	3.2	25	0.00	0.964															
26	0.00	1.070	0.951	7.3	<0.05	0.1	252	7.2	57		297	11.8	94		4.4		26	0.00	0.951															
27	0.00	1.051	1.288	7.2	<0.05	0.1									3.3		27	0.00	1.288															
28	0.00	1.052	1.010	7.4	<0.05	0.1									9.9		28	0.00	1.010															
29	0.00	1.056	0.915	7.5	<0.05	0.1	225	9.1	8.2	69	63.5	260	14.2	12.5	108	96.5	29	0.00	0.915	31.4	13.3													
30	0.00	1.072	0.937	7.3	<0.05	<0.1									3.8	5.1	30	0.00	0.937															
TOTAL	0.79	32.76	29.86														TOTAL	0.79	29.86															

(MEDIAN)																														
AVG	0.03	1.092	0.995	7.2	<0.05	<0.1	233	7.6		62			265	12.2		99		8	4.0	4.3	AVG	0.03	0.995	30.3	11.3	0.015	15.0	0.010	10.0	<5.0
MIN	0.00	1.045	0.913	7.1	<0.05	<0.1	153	5.7		45			213	10.7		87		4.5	1.7		MIN	0.00	0.913	27.8	8.1	0.015	15.0	0.010	10.0	<5.0
MAX	0.56	1.165	1.288	7.5	<0.05	0.1	283	9.1		73			302	14.2		118		33	9.9		MAX	0.56	1.288	32.1	16.6	0.015	15.0	0.010	10.0	<5.0

DISCHARGE LIMITS:																		ND = NON DETECTED						NA = NOT ANALYZED											
INSTANT MAX.				1.8		3													400	225															
DAILY MAX.				0.24		0.2																													
7 DAY AVG.									45		700		45						100																
30 DAY AVG.											465		30						75																
DAILY MAX. OF 10% pH				6.09.0																43															
SIX MONTH MEDIAN				0.06																															
																		ANALYTE																	
																		TOTAL COPPER						METHOD USED											
																		TOTAL ZINC						EPA 200.7											
																		GREASE & OIL						EPA 200.7											
																		CHLOROFORM						EPA 1664											
																								EPA 624											
																								PQL											
																								0.020											
																								0.050											
																								5.0											
																								0.50											

42.31 TOTAL RAINFALL (year-to-date) TSS **96.74** BOD **95.39**

CITY OF CRESCENT CITY WPCF - SUMMARY OF TREATMENT REPORT

C

DISCHARGE MONITORING - PERMIT No. CA0022756

ORDER # R1-2017-0002 ID # 1A84006ODN

JUL 2018

ALL SAMPLES ARE FROM MONITORING LOCATION EFF-001 WITH EXCEPTION OF THE THREE IN BOLD MARKED INF

Page 1

JUL 2018

DAY	DAILY REQUIREMENTS							WEEKLY REQUIREMENTS											DAY			
	RAIN IN	INF FLOW MGD	FLOW MGD	pH	TOTAL CL ₂ mg/L	Settleable Solids		SUSPENDED SOLIDS					BOD 5					FECAL MPN		TURB NTU	TURB Wkly Avg	
						EFF	Wkly Avg(mg/L)	INF mg/L	EFF mg/L	Wkly Avg (mg/L)	LBS/DAY	Wkly Avg(lb/day)	INF mg/L	EFF mg/L	Wkly Avg(mg/L)	LBS/DAY	Wkly Avg(lb/day)					
1	0.00	1.072	0.928	7.2	<0.05	<0.1	<0.1	265	9.4	8.0	73	63	322	14.4	13.6	111	106		4.7	4.7	1	
2	0.00	1.087	0.933	7.2	<0.05	<0.1												7.8	5.5		2	
3	0.00	1.089	0.933	7.3	<0.05	<0.1		283	8.0		62		301	14.6		114		4.0	3.9		3	
4	0.00	1.027	0.850	7.3	<0.05	<0.1												4.0	3.9		4	
5	0.00	1.095	0.959	7.3	<0.05	<0.1		152	6.7		54		217	11.8		94			5		5	
6	0.00	1.081	0.910	7.4	<0.05	<0.1													5.4			6
7	0.00	1.061	0.933	7.4	<0.05	<0.1												<1.8	3.6		7	
8	0.00	1.046	0.892	7.3	<0.05	<0.1	0.079	322	7.4	7.2	55	53.9	309	14.6	14.3	109	107		3.4	4.9	8	
9	0.00	1.060	0.929	7.4	<0.05	<0.1												<1.8	5.1		9	
10	0.00	1.057	0.901	7.3	<0.05	<0.1		210	7.1		53		281	13.9		104			3.6		10	
11	0.00	1.040	0.886	7.4	<0.05	<0.1												7.8	5.1		11	
12	0.00	1.023	0.914	7.5	<0.05	<0.1		247	7.0		53								6.5		12	
13	0.00	1.025	0.932	7.5	<0.05	0.1													7.2		13	
14	0.00	0.998	0.864	7.3	<0.05	0.2												2.0	3.6		14	
15	0.00	1.006	0.877	7.3	<0.05	0.1	0.064	300	7.0	7.1	51	52.5	287	10.6	11.7	78	87		3.2	4.3	15	
16	0.00	1.016	0.910	7.4	<0.05	<0.1												2.0	4.7		16	
17	0.00	1.027	0.908	7.3	<0.05	<0.1		193	7.0		53		238	12.5		95			4.4		17	
18	0.00	1.023	0.843	7.4	<0.05	<0.1												13.0	3.9		18	
19	0.00	1.017	0.875	7.3	<0.05	<0.1		186	7.3		53		225	12.1		88			4.5		19	
20	0.00	1.012	1.001	7.4	<0.05	0.1													5.4		20	
21	0.00	1.048	0.847	7.3	<0.05	<0.1												6.8	3.8		21	
22	0.00	0.988	0.860	7.3	<0.05	<0.1	<0.1	268	6.8	7.4	49	54.6	314	12.8	18.2	92	135		3.2	3.9	22	
23	0.00	1.011	0.901	7.4	<0.05	<0.1												7.8	4.7		23	
24	0.00	1.008	0.873	7.3	<0.05	<0.1		211	7.1		52								3.3		24	
25	0.01	1.024	0.929	7.5	<0.05	<0.1													5.9		25	
26	0.00	1.018	0.903	7.4	<0.05	<0.1		283	8.4		63		333	23.6		178			4.1		26	
27	0.00	1.033	0.932	7.4	<0.05	<0.1													3		27	
28	0.02	1.022	0.898	7.3	<0.05	<0.1													3.4		28	
29	0.02	1.014	0.875	7.3	<0.05	<0.1		238	8.1		59		299	12.1		88			2.5		29	
30	0.01	0.993	0.916	7.3	<0.05	<0.1												7.8	3.1		30	
31	0.01	1.011	0.921	7.4	<0.05	<0.1		177	7.3		56		257	15.3		118			4.8		31	
TOTAL	0.07	32.03	28.03																		TOTAL	

(MEDIAN)

AVG	0.00	1.03	0.904	7.35	<0.05	<0.1		238	7.5		56		282	14.0		106		7.8	4.4		AVG
MIN	0.00	0.99	0.843	7.22	<0.05	0.10		152	6.7		49		217	10.6		77.5		2	2.5		MIN
MAX	0.02	1.10	1.00	7.49	<0.05	0.20	0.079	322	9.4	8.0	73	63	333	23.6	18.2	178	135	13	7.2	4.9	MAX

DISCHARGE LIMITS:

INSTANT MAX.				1.8		3													225	ND = NON DET.
DAILY MAX.				0.24																
7 DAY AVG.						1.5		45		700		45						100		
30 DAY AVG.						1		30		465		30						14	75	
DAILY MAX. OF 10% pH				6.0/9.0														43		
SIX MONTH MEDIAN						0.06														

TSS 85% REMOVAL

BOD 75% REMOVAL

TOTAL RAINFALL (year-to-date):	38.5	CALCULATED % REMOVALS	
		TSS 96.86	BOD 95.03

ITY OF CRESCENT CITY WPCF - SUMMARY OF TREATMENT REPORT

DISCHARGE MONITORING - PERMIT No. CA0022756

ORDER # R1-2017-0002 ID # 1A84006ODN

ALL SAMPLES ARE FROM MONITORING LOCATION EFF-001 WITH EXCEPTION OF THE
THREE IN BOLD MARKED INF

RAIN IN	FLOW MGD	INF TOTAL AMMONIA mg/L	ONE SAMPLE PER MONTH REQUIRED					GREASE & OIL mg/L
			TOTAL AMMONIA mg/L	TOTAL COPPER mg/L	TOTAL COPPER ug/L	TOTAL NICKEL mg/L	TOTAL NICKEL ug/L	
0.00	0.928	32.4	13.2					
0.00	0.933							
0.00	0.933							
0.00	0.850							
0.00	0.959	36.0	11.9					
0.00	0.910							
0.00	0.933							
0.00	0.892	32.3	15.2					
0.00	0.929							
0.00	0.901							
0.00	0.886							
0.00	0.914	31.2	12					
0.00	0.932							
0.00	0.864							
0.00	0.877	32.2	12.5					
0.00	0.910							
0.00	0.908			0.013	13	0.007	6.700	<4.8
0.00	0.843							
0.00	0.875	32.20	15.9					
0.00	1.001							
0.00	0.847							
0.00	0.860	34.3	12.6					
0.00	0.901							
0.00	0.873							
0.01	0.929							
0.00	0.903	36.7	16.1					
0.00	0.932							
0.02	0.898							
0.02	0.875	36.9	13.6					
0.01	0.916							
0.01	0.921							
0.07	28.03							

0.00	0.904	33.8	13.7	0.013	13.0	0.007	6.7	<4.8
0.00	0.843	31.2	11.9	0.013	13.0	0.007	6.7	<4.8
0.02	1.00	36.9	16.1	0.013	13.0	0.007	6.7	<4.8

ECTED

NA = NOT ANALYZED

R	<p>METHOD USED EPA 200.7 EPA 200.7 EPA 1664</p>
---	--

CITY OF CRESCENT CITY WPCF - SUMMARY OF TREATMENT REPORT

CITY OF C

DISCHARGE MONITORING - PERMIT No. CA0022756

ORDER # R1-2017-0002 ID # 1A84006ODN

Aug-18

Aug-18

ALL SAMPLES ARE FROM MONITORING LOCATION EFF-001 WITH EXCEPTION OF THE THREE IN BOLD MARKED INF

DAY	DAILY REQUIREMENTS						WEEKLY REQUIREMENTS													DAY	RAIN IN	
	RAIN IN	INF FLOW MGD	FLOW MGD	pH	TOTAL CL ₂ mg/L	Settleable Solids		SUSPENDED SOLIDS					BOD 5					FECAL MPN	TURB NTU			TURB Wkly Avg
						EFF	Wkly Avg(mg/L)	INF mg/L	EFF mg/L	Wkly Avg (mg/L)	LBS/DAY	Wkly Avg(lb/day)	INF mg/L	EFF mg/L	Wkly Avg(mg/L)	LBS/DAY	Wkly Avg(lb/day)					
1	0.01	1.025	0.942	7.3	<0.05	<0.1	<0.1			8.4		63			14.7	111	<1.8	4.6	4.8	1	0.01	
2	0.00	1.024	0.907	7.4	<0.05	<0.1		252	9.9		75			279	16.6			5		2	0.00	
3	0.00	1.025	0.932	7.5	<0.05	<0.1												5.3		3	0.00	
4	0.00	1.004	0.929	7.5	<0.05	<0.1											2.0	4.5		4	0.00	
5	0.00	1.009	0.890	7.4	<0.05	0.1		186	9.3	10.0	69	74	284	15.9	19.6	118	145		4.7		5	0.00
6	0.02	0.984	0.892	7.4	<0.05	<0.1											33.0	5.3		6	0.02	
7	0.01	0.996	0.883	7.3	<0.05	0.1		249	8.6		63		302	16.3		120		4.5		7	0.01	
8	0.01	1.120	0.898	7.5	<0.05	0.2	0.079										6.1	8.1	6.5	8	0.01	
9	0.01	0.984	0.891	7.5	<0.05	<0.1		234	12.2		91		301	26.5		197		6.3		9	0.01	
10	0.02	0.983	0.903	7.5	<0.05	0.1												6.8		10	0.02	
11	0.01	0.970	0.865	7.5	<0.05	<0.1											2.0	6.5		11	0.01	
12	0.00	0.953	0.881	7.4	<0.05	<0.1		265	10.6	9.5	78	70	317	16.9	14.6	124	109		4.8		12	0.00
13	0.01	0.939	0.864	7.4	<0.05	<0.1											4.5	6.4		13	0.01	
14	0.00	0.967	0.893	7.5	<0.05	<0.1		252	9.7		72		330	15.9		118		6.6		14	0.00	
15	0.01	0.966	0.779	7.4	<0.05	<0.1	0.057										<1.8	4.5	4.9	15	0.01	
16	0.01	0.960	0.906	7.4	<0.05	<0.1		209	8.1		61		256	11.0		83		3.6		16	0.01	
17	0.00	0.973	0.972	7.5	<0.05	0.1												9.7		17	0.00	
18	0.00	0.950	0.877	7.3	<0.05	<0.1											7.8	3.6		18	0.00	
19	0.00	0.958	0.867	7.3	<0.05	<0.1		234	11.6	9.9	84	73	272	14.2	15.1	103	112		3.1		19	0.00
20	0.00	0.960	0.911	7.4	<0.05	<0.1											2.0	4.8		20	0.00	
21	0.00	0.948	0.892	7.4	<0.05	<0.1		251	9.2		68		291	17.0		126		4.9		21	0.00	
22	0.01	0.961	0.900	7.5	<0.05	<0.1	<0.1											5.7	6.0	22	0.01	
23	0.00	0.941	0.899	7.5	<0.05	<0.1		195	9.0		67		262	14.1		106		5.8		23	0.00	
24	0.00	0.926	0.890	7.5	<0.05	<0.1												7.7		24	0.00	
25	0.00	0.931	0.859	7.4	<0.05	<0.1												4.9		25	0.00	
26	0.00	0.997	0.887	7.4	<0.05	<0.1	0.057	242	11.6	10.5	86	78	302	15.9	13.0	118		4.8	6.2	26	0.00	
27	0.00	1.118	1.009	7.5	<0.05	0.1											4.5	8.8		27	0.00	
28	0.01	0.966	0.914	7.4	<0.05	<0.1		197	10.9		83		242	12.4		95		4.5		28	0.01	
29	0.01	0.939	0.883	7.5	<0.05	<0.1												6.7		29	0.01	
30	0.01	0.927	0.866	7.4	<0.05	<0.1		208	8.9		64		237	11		78		5.6		30	0.01	
31	0.01	0.918	0.878	7.4	<0.05	<0.1												5.8		31	0.01	
TOTAL	0.17	30.32	27.76																	TOTAL	0.17	

(MEDIAN)

AVG	0.01	0.978	0.895	7.42	<0.05	<0.1		229	10.0		74		283	15.7		116		4.5	5.6		AVG	0.01
MIN	0.00	0.918	0.779	7.26	<0.05	<0.1		186	8.1		61		237	10.8		78.0		2	3.1		MIN	0.00
MAX	0.02	1.12	1.01	7.53	<0.05	0.20	0.079	265	12.2	10.5	91	78	330	26.5	19.6	197	145	33	9.7	6.5	MAX	0.02

DISCHARGE LIMITS:																						
INSTANT MAX.				1.8	3													225			ND = NON DETECTED	
DAILY MAX.				0.24																		
7 DAY AVG.					1.5				45		700			45						100		
30 DAY AVG.					1				30		465			30						75		
DAILY MAX. OF 10%						1																
pH				6.0/9.0																		
SIX MONTH MEDIAN				0.06																		

TSS 85% REMOVAL BOD 75% REMOVAL

TOTAL RAINFALL (year-to-date):	38.67	CALCULATED % REMOVALS	
		TSS 95.64	BOD 94.46

RESCENT CITY WPCF - SUMMARY OF TREATMENT REPORT

DISCHARGE MONITORING - PERMIT No. CA0022756

ORDER # R1-2017-0002 ID # 1A84006ODN

ALL SAMPLES ARE FROM MONITORING LOCATION EFF-001 WITH EXCEPTION OF THE THREE IN BOLD MARKED INF

FLOW MGD	INF TOTAL AMMONIA mg/L	ONE SAMPLE PER MONTH REQUIRED					
		TOTAL AMMONIA mg/L	TOTAL COPPER mg/L	TOTAL COPPER ug/L	TOTAL NICKEL mg/L	TOTAL NICKEL ug/L	GREASE & OIL mg/L
0.942							
0.907	32.4	19.1					
0.932							
0.929							
0.890	33.8	17.6					
0.892							
0.883							
0.898							
0.891	29.3	16.5					
0.903							
0.865							
0.881	32.6	12.5					
0.864							
0.893			0.012	12.000	0.010	9.700	ND<5.9
0.779							
0.906	33.2	10.1					
0.972							
0.877							
0.867	35.70	15.8					
0.911							
0.892							
0.900							
0.899	29.5	11.9					
0.890							
0.859							
0.887	34.2	15.5					
1.009							
0.914							
0.883							
0.866	34.6	17.2					
0.878							
27.76							

0.895	32.8	15.1	0.012	12.0	0.010	9.7	0.00
0.779	29.3	10.1	0.012	12.0	0.010	9.7	0.00
1.009	35.7	19.1	0.012	12.0	0.010	9.7	0.00

NA = NOT ANALYZED

Units	METHOD USED	Daily Max	Avg. Monthly	Avg. Wkly	Inst. Max
ug/L	EPA 200.7	300			1500.000
ug/L	EPA 200.7	600			
mg/L	EPA 1664		25	40	75.0

CITY OF CRESCENT CITY WPCF - SUMMARY OF TREATMENT REPORT

C

DISCHARGE MONITORING - PERMIT No. CA0022756

ORDER # R1-2017-0002 ID # 1A84006ODN

Sep-18

Sep-18

ALL SAMPLES ARE FROM MONITORING LOCATION EFF-001 WITH EXCEPTION OF THE THREE IN BOLD MARKED INF

DAY	DAILY REQUIREMENTS						WEEKLY REQUIREMENTS											DAY			
	RAIN IN	INF FLOW MGD	FLOW MGD	pH	TOTAL CL ₂ mg/L	Settleable Solids		SUSPENDED SOLIDS				BOD 5					FECAL MPN		TURB NTU	TURB Wkly Avg	
						EFF	Wkly Avg(mg/L)	INF mg/L	EFF mg/L	Wkly Avg (mg/L)	LBS/DAY	Wkly Avg(lb/day)	INF mg/L	EFF mg/L	Wkly Avg(mg/L)	LBS/DAY					Wkly Avg(lb/day)
1	0.00	0.941	0.895	7.51	<0.05	<0.1												6.1	7.1		1
2	0.00	0.948	0.858	7.33	<0.05	0.1	0.057	222	10.9	10.8	78	78	291	14.6	14.7	104	105		6.1	6.8	2
3	0.00	0.949	0.899	7.36	<0.05	<0.1												<1.8	5.4		3
4	0.00	0.917	0.844	7.44	<0.05	<0.1		311	11.1		78		338	15.9		112			7.9		4
5	0.00	0.936	0.922	7.61	<0.05	<0.1												4.5	6.7		5
6	0.00	0.960	0.878	7.52	<0.05	<0.1		203	10.5		77		265	13.5		99			8.1		6
7	0.00	0.932	0.890	7.55	<0.05	<0.1													7.6		7
8	0.00	0.926	0.865	7.51	<0.05	<0.1												4.0	6		8
9	0.00	0.948	0.847	7.45	<0.05	<0.1	0.057			9.5		67			11.4		81		5.4	5.1	9
10	0.00	0.917	0.848	7.44	<0.05	<0.1		315	12.8		91		321	13.5		95		7.8	6.2		10
11	0.01	0.944	0.878	7.52	<0.05	<0.1													6.3		11
12	0.01	0.954	0.856	7.53	<0.05	0.1		240	8.5		61		308	12.2		87		4.5	5.3		12
13	0.00	0.920	0.821	7.47	<0.05	<0.1													5		13
14	0.00	0.936	0.850	7.40	<0.05	<0.1		265	7.1		50		294	8.5		60			5		14
15	0.00	0.944	0.840	7.27	<0.05	<0.1												6.8	2.8		15
16	0.00	0.965	0.896	7.26	<0.05	<0.1	0.071			6.7		48			8.3		59		2.8	5.0	16
17	0.00	0.950	0.835	7.39	<0.05	<0.1		227	7.4		52		261	9.5		66		6.8	4.9		17
18	0.00	0.961	0.866	7.17	<0.05	<0.1													3		18
19	0.00	0.963	0.793	7.33	<0.05	0.1		215	6.2		41		278	7.6		50		2.0	4.7		19
20	0.00	0.970	0.945	7.33	<0.05	0.1		232	6.4		50		279	7.7		61			10		20
21	0.00	0.961	0.877	7.43	<0.05	0.1													6.5		21
22	0.00	0.952	0.888	7.15	<0.05	<0.1												11.0	2.8		22
23	0.00	0.971	0.866	7.05	<0.05	<0.1	0.086			8.7		64			11.5		85		2.5	4.3	23
24	0.00	0.941	0.871	7.14	<0.05	<0.1		229	8.1		59		285	11.7		85		14.0	4.1		24
25	0.01	0.951	0.875	7.27	<0.05	<0.1													5.3		25
26	0.01	0.977	0.868	7.07	<0.05	0.1		237	9.3		67							11.0	3.9		26
27	0.00	0.977	0.901	7.35	<0.05	0.1		213	8.8		66		287	11.3		85			7.1		27
28	0.00	0.949	0.912	7.30	<0.05	<0.1													4.8		28
29	0.17	0.960	0.866	7.02	<0.05	0.2												11.0	2.7		29
30	0.02	0.970	0.886	7.05	<0.05	<0.1													2.9		30
TOTAL	0.23	28.49	26.14																		TOTAL

*9/29/18 INF FLOW= NR, averaged day before and after to obtain "total" Inf Flow data

(MEDIAN)

AVG	0.01	0.950	0.871	7.34	<0.05	<0.1		242	8.9		64		292	11.5		82		6.8	5.3		AVG
MIN	0.00	0.917	0.793	7.02	<0.05	<0.1		203	6.2		41		261	7.6		50.3		<1.8	2.5		MIN
MAX	0.17	0.98	0.95	7.61	<0.05	0.20	0.086	315	12.8	10.8	91	78	338	15.9	14.7	112	105	14	10.0	6.8	MAX

DISCHARGE LIMITS:																					
INSTANT MAX.					1.8	3													225		ND = NON DET.
DAILY MAX.					0.24																
7 DAY AVG.						1.5			45		700		45						100		
30 DAY AVG.						1			30		465		30					14	75		ANALYTE
DAILY MAX. OF 10%								1										43			TOTAL COPPER
pH				6.09.0																	TOTAL NICKEL
SIX MONTH MEDIAN					0.06																GREASE & OIL

TOTAL RAINFALL (year-to-date): 38.9

TSS 85% REMOVAL BOD 75% REMOVAL

TSS 96.32 CALCULATED % REMOVALS BOD 96.07

ITY OF CRESCENT CITY WPCF - SUMMARY OF TREATMENT REPORT

DISCHARGE MONITORING - PERMIT No. CA0022756

ORDER # R1-2017-0002 ID # 1A84006ODN

ALL SAMPLES ARE FROM MONITORING LOCATION EFF-001 WITH EXCEPTION OF THE THREE IN BOLD MARKED INF

RAIN IN	FLOW MGD	INF TOTAL AMMONIA mg/L	ONE SAMPLE PER MONTH REQUIRED					GREASE & OIL mg/L
			TOTAL AMMONIA mg/L	TOTAL COPPER mg/L	TOTAL COPPER ug/L	TOTAL NICKEL mg/L	TOTAL NICKEL ug/L	
0.00	0.895							
0.00	0.858	38.2	18.4					
0.00	0.899							
0.00	0.844							
0.00	0.922							
0.00	0.878	34.2	19.1					
0.00	0.890							
0.00	0.865							
0.00	0.847							
0.00	0.848	36.9	13.8					
0.01	0.878							
0.01	0.856							
0.00	0.821							
0.00	0.850	34.7	11.8					
0.00	0.840							
0.00	0.896							
0.00	0.835	36.5	12					
0.00	0.866							
0.00	0.793							
0.00	0.945	33.8	12					
0.00	0.877							
0.00	0.888							
0.00	0.866							
0.00	0.871	35.2	6.7					
0.01	0.875			0.012	12	0.0055	5.500	ND<5.6
0.01	0.868							
0.00	0.901	30.3	6.7					
0.00	0.912							
0.17	0.866							
0.02	0.886							
0.23	26.14							

0.01	0.871	35.0	12.6	0.012	12.0	0.0055	5.5	ND<5.6
0.00	0.793	30.3	6.7	0.012	12.0	0.0055	5.5	ND<5.6
0.17	0.945	38.2	19.1	0.012	12.0	0.0055	5.5	ND<5.6

ECTED

NA = NOT ANALYZED

Units	METHOD USED	Daily Max	Avg. Monthly	Avg. Wkly	Inst. Max
ug/L	EPA 200.7	300			1500.000
ug/L	EPA 200.7	600			
mg/L	EPA 1664		25	40	75.0

CITY OF CRESCENT CITY WPCF - SUMMARY OF TREATMENT REPORT

CITY OF C

DISCHARGE MONITORING - PERMIT No. CA0022756

ORDER # R1-2017-0002 ID # 1A84006ODN

Oct. 2018

Oct. 2018

ALL SAMPLES ARE FROM MONITORING LOCATION EFF-001 WITH EXCEPTION OF THE THREE IN BOLD MARKED INF

DAY	DAILY REQUIREMENTS					WEEKLY REQUIREMENTS													DAY	RAIN IN				
	RAIN IN	INF FLOW MGD	FLOW MGD	pH	TOTAL CL ₂ mg/L	Settleable Solids		SUSPENDED SOLIDS					BOD 5					FECAL MPN			TURB NTU	TURB Wkly Avg		
						EFF	Wkly Avg(mg/L)	INF mg/L	EFF mg/L	Wkly Avg (mg/L)	LBS/DAY	Wkly Avg(lb/day)	INF mg/L	EFF mg/L	Wkly Avg(mg/L)	LBS/DAY	Wkly Avg(lb/day)							
1	0.10	0.944	0.883	7.21	<0.05	<0.1	<0.1	222	9.1	8.4	67	60	265	11.7	11.3	86	80						1	0.10
2	0.00	0.937	0.916	7.17	<0.05	<0.1													<1.8	3.9	4.1		2	0.00
3	0.00	0.951	0.885	7.28	<0.05	<0.1		219	7.9		58		266	10.1		75		4.5	2.8				3	0.00
4	0.00	0.957	0.795	7.41	<0.05	<0.1		255	8.3		55		356	12.0		80			3.8				4	0.00
5	0.57	0.991	1.014	7.28	<0.05	<0.1													4.8				5	0.57
6	0.01	0.956	0.896	7.46	<0.05	<0.1												6.1	4.5				6	0.01
7	0.00	0.949	0.855	7.28	<0.05	<0.1	<0.1			7.5		55			10.6		77		2.2	3.8			7	0.00
8	0.00	0.979	0.927	7.38	<0.05	<0.1		242	7.6		59		282	11.1		86		13.0	3.7				8	0.00
9	0.00	0.957	0.912	7.41	<0.05	<0.1													4.8				9	0.00
10	0.01	0.935	0.847	7.30	<0.05	<0.1		231	7.0		49		302	10.5		74		4.5	3.3				10	0.01
11	0.00	0.953	0.850	7.36	<0.05	<0.1		239	7.9		56		300	10.2		72			3.9				11	0.00
12	0.00	0.931	0.866	7.31	<0.05	<0.1													5.1				12	0.00
13	0.00	0.946	0.859	7.39	<0.05	<0.1												4.5	3.5				13	0.00
14	0.01	0.950	0.834	7.34	<0.05	<0.1	<0.1			8.1		59			12.8		94		3	4.2			14	0.01
15	0.00	0.912	0.848	7.40	<0.05	<0.1		237					289					<1.8	5.1				15	0.00
16	0.00	0.947	0.846	7.36	<0.05	<0.1													3.4				16	0.00
17	0.00	0.928	0.894	7.30	<0.05	0.1		197	7.3		54		251	12.0		89			2.9				17	0.00
18	0.00	0.964	0.872	7.39	<0.05	<0.1		259	8.6		63		282	13.6		99			6.1				18	0.00
19	0.00	0.904	0.863	7.35	<0.05	<0.1		249	8.4		60								5.3				19	0.00
20	0.00	0.941	0.842	7.26	<0.05	<0.1												2.0	3.6				20	0.00
21	0.00	0.946	0.862	7.27	<0.05	<0.1	<0.1			8.5		64			16.4		125		3.8	4.7			21	0.00
22	0.00	0.956	0.904	7.34	<0.05	<0.1		180	8.1		61		274	16.1		121		4.5	3.9				22	0.00
23	0.15	0.986	0.939	7.44	<0.05	<0.1													4.2				23	0.15
24	0.00	0.984	0.905	7.40	<0.05	<0.1		252	9.4		71		314	17.4		131			5.3				24	0.00
25	0.01	0.990	0.920	7.55	<0.05	<0.1		216	8.0		61		279	15.8		121			6.8				25	0.01
26	0.12	0.947	0.897	7.47	<0.05	<0.1													5.8				26	0.12
27	1.12	0.911	0.955	7.45	<0.05	<0.1													3.4				27	1.12
28	0.01	1.049	1.003	7.40	<0.05	<0.1	<0.1			8.4		11			15.5		117		6.4	5.4			28	0.01
29	0.11	0.972	0.927	7.47	<0.05	<0.1		244	10.3		80		363	16.7		129		<1.8	5.6				29	0.11
30	0.02	0.999	0.911	7.56	<0.05	<0.1													7.4				30	0.02
31	0.00	0.950	0.903	7.44	<0.05	<0.1		262	7.6		57		407	15.1		114			4				31	0.00
1	0.00	0.979	0.887			<0.1		193	7.2		53		252	14.7		109			5.4					0.00
2	0.00	0.966	0.923			<0.1													4.5					0.00
3	0.01	0.982	0.893			<0.1													4.2					0.01
TOTAL	2.24	29.62	27.63																				TOTAL	2.24
Monthly																							(MEDIAN)	
AVG	0.07	0.96	0.89	7.37	<0.05	<0.1	<0.1	234	8.3		61		302	13.3		98		4.5	4.5			AVG	0.07	
MIN	0.00	0.90	0.80	7.17	<0.05	<0.1	<0.1	180	7.0		49		251	10.1		72.3		2	2.2			MIN	0.00	
MAX	1.12	1.05	1.01	7.56	<0.05	0.10	<0.1	262	10.3	8.5	80	64	407	17.4	16.4	131	125	13	7.4	5.4		MAX	1.12	
DISCHARGE LIMITS:																								
INSTANT MAX.					1.8	3													225			ND = NON DETECTED		
DAILY MAX.					0.24																			
7 DAY AVG.						1.5			45		700		45						100					
30 DAY AVG.						1			30		465		30					14	75			ANALYTE		
DAILY MAX. OF 10%							1											43				TOTAL COPPER		
pH				6.09.0																		TOTAL NICKEL		
SIX MONTH MEDIAN					0.06																	GREASE & OIL		
TSS 85% REMOVAL																							BOD 75% REMOVAL	
TOTAL RAINFALL (year-to-date): 41.14																							CALCULATED % REMOVALS	
TSS 96.47																							BOD 95.61	

RESCENT CITY WPCF - SUMMARY OF TREATMENT REPORT

DISCHARGE MONITORING - PERMIT No. CA0022756

ORDER # R1-2017-0002 ID # 1A84006ODN

ALL SAMPLES ARE FROM MONITORING LOCATION EFF-001 WITH EXCEPTION OF THE
THREE IN BOLD MARKED INF

FLOW MGD	INF TOTAL AMMONIA mg/L	ONE SAMPLE PER MONTH REQUIRED					GREASE & OIL mg/L
		TOTAL AMMONIA mg/L	TOTAL COPPER mg/L	TOTAL COPPER ug/L	TOTAL NICKEL mg/L	TOTAL NICKEL ug/L	
0.883							
0.916							
0.885	32.3	10.4					
0.795	34.9	12.4					
1.014							
0.896							
0.855							
0.927	30.9	5.8					
0.912							
0.847							
0.850	31.2	5.4					
0.866							
0.859							
0.834							
0.848	32.4						
0.846			0.0012	12	0.0083	8.3	ND<5.8
0.894							
0.872	38.8	13.9					
0.863	36.0	10.1					
0.842							
0.862							
0.904	33.1	9.7					
0.939							
0.905							
0.920	34.7	11.2					
0.897							
0.955							
1.003							
0.927	28.3	9.1					
0.911							
0.903							
0.887							
0.923							
0.893							
27.63							

0.891	33.3	9.8	0.0012	12.0	0.0083	8.3	ND<5.8
0.795	28.3	5.4	0.0012	12.0	0.0083	8.3	ND<5.8
1.014	38.8	13.9	0.0012	12.0	0.0083	8.3	ND<5.8

NA = NOT ANALYZED

Units	METHOD USED	Daily Max	Avg. Monthly	Avg. Wkly	Inst. Max
ug/L	EPA 200.7	300			1500.000
ug/L	EPA 200.7	600			
mg/L	EPA 1664		25	40	75.0

CITY OF CRESCENT CITY WPCF - SUMMARY OF TREATMENT REPORT

CITY OF C

DISCHARGE MONITORING - PERMIT No. CA0022756

ORDER # R1-2017-0002 ID # 1A84006ODN

Nov. 2018

Nov. 2018

ALL SAMPLES ARE FROM MONITORING LOCATION EFF-001 WITH EXCEPTION OF THE THREE IN BOLD MARKED INF

DAY	DAILY REQUIREMENTS						WEEKLY REQUIREMENTS															DAY	RAIN IN
	RAIN IN	INF FLOW MGD	FLOW MGD	pH	TOTAL CL ₂ mg/L	Settleable Solids		SUSPENDED SOLIDS					BOD 5					FECAL MPN	TURB NTU	TURB Wkly Avg			
						EFF	Wkly Avg(mg/L)	INF mg/L	EFF mg/L	Wkly Avg (mg/L)	LBS/DAY	Wkly Avg(lb/day)	INF mg/L	EFF mg/L	Wkly Avg(mg/L)	LBS/DAY	Wkly Avg(lb/day)						
1	0.00	0.979	0.887	7.52	<0.05	<0.1	x	193	7.2	x	53	x	252	14.7	x	109	x		5.4	x	1	0.00	
2	0.00	0.966	0.923	7.39	<0.05	<0.1													4.5		2	0.00	
3	0.01	0.982	0.893	7.36	<0.05	<0.1												<1.8	4.2		3	0.01	
4	0.020	0.950	0.796	7.38	<0.05	<0.1	<0.1			10.7		82			21.7		167		3.4	8.7	4	0.02	
5	0.000	0.916	0.891	7.39	<0.05	<0.1		255	10.3		77		289	19.8		147		4.5	8.2		5	0.00	
6	0.000	0.929	0.907	7.55	<0.05	<0.1													9.6		6	0.00	
7	0.000	0.940	0.967	7.49	<0.05	<0.1		208	9.0		73		297	19.9		160		4.5	8.6		7	0.00	
8	0.000	0.917	0.912	7.58	<0.05	<0.1		275	12.7		97		270	25.5		194			9.8		8	0.00	
9	0.000	0.877	0.808	7.58	<0.05	<0.1													14		9	0.00	
10	0.000	0.828	0.904	7.49	<0.05	<0.1												2.0	7.4		10	0.00	
11	0.00	0.891	0.835	7.42	<0.05	<0.1	<0.1			10.2		69			20.0		136		8.1	8.2	11	0.00	
12	0.00	0.904	0.809	7.42	<0.05	<0.1		207	11.7		79		295	25.1		169		<1.8	7.3		12	0.00	
13	0.00	0.886	0.860	7.43	<0.05	<0.1													7.6		13	0.00	
14	0.00	0.906	0.828	7.45	<0.05	<0.1		194	9.2		64		296	17.8		123		11.0	7.3		14	0.00	
15	0.00	0.893	0.818	7.66	<0.05	<0.1		209	9.6		65		262	17.0		116			9.2		15	0.00	
16	0.00	0.894	0.894	7.48	<0.05	0.1													9.5		16	0.00	
17	0.00	0.914	0.889	7.45	<0.05	<0.1												2.0	8.5		17	0.00	
18	0.00	0.920	0.806	7.42	<0.05	0.1	<0.1			10.9		85			22.0		172		8.4	8.8	18	0.00	
19	0.01	0.968	0.852	7.57	<0.05	<0.1		145	10.9		77		311	21.5		153		<1.8	9.1		19	0.01	
20	0.80	0.951	0.840	7.44	<0.05	<0.1													7.5		20	0.80	
21	0.34	1.036	0.988	7.52	<0.05	<0.1		206	9.2		76		283	20.3		167		2.0	8.7		21	0.34	
22	2.35	1.041	0.974	7.44	<0.05	<0.1		224	12.6		102		282	24.2		197			8.3		22	2.35	
23	0.11	1.249	1.176	7.56	<0.05	<0.1													11		23	0.11	
24	0.01	1.085	0.942	7.37	<0.05	<0.1													8.7		24	0.01	
25	0.00	1.062	0.954	7.40	<0.05	<0.1	<0.1			9.6		86			17.4		155		6.7	8.1	25	0.00	
26	1.10	1.039	0.920	7.47	<0.05	<0.1		229	10.4		80		328	20.0		153		<1.8	9.3		26	1.10	
27	0.71	1.255	1.151	7.57	<0.05	0.1													9.6		27	0.71	
28	0.46	1.288	1.163	7.41	<0.05	0.1		172	10.2		99		235	16.6		161			9.7		28	0.46	
29	0.26	1.279	1.159	7.55	<0.05	0.1		143	8.3		80		197	15.7		152			7.2		29	0.26	
30	0.45	1.190	1.094	7.49	<0.05	<0.1													7.8		30	0.45	
1					<0.05	<0.1													6.3		1		
TOTAL	6.63	29.94	27.84																		TOTAL	6.63	

(MEDIAN)

AVG	0.22	1.00	0.93	7.48	<0.05	0.10		205	10.1		79		277	19.9		154		3.3	8.2		AVG	0.22
MIN	0.00	0.83	0.80	7.36	<0.05	<0.1		143	7.2		53		197	14.7		108.7		2.0	3.4		MIN	0.00
MAX	2.35	1.29	1.18	7.66	<0.05	0.10	<0.1	275	12.7	10.9	102	86	328	25.5	22.0	197	172	11	14.0	8.8	MAX	2.35

DISCHARGE LIMITS:																						
INSTANT MAX.				1.8	3														225	ND = NON DETECTED		
DAILY MAX.				0.24																		
7 DAY AVG.					1.5				45		700			45					100			
30 DAY AVG.					1				30		465			30				14	75			
DAILY MAX. OF 10%						1												43				
pH				6.0/9.0																		
SIX MONTH MEDIAN				0.06																		
											TSS 85% REMOVAL					BOD 75% REMOVAL						

TOTAL RAINFALL (year-to-date): 47.77

CALCULATED % REMOVALS

TSS 95.06

BOD 92.82

RESCENT CITY WPCF - SUMMARY OF TREATMENT REPORT

DISCHARGE MONITORING - PERMIT No. CA0022756

ORDER # R1-2017-0002 ID # 1A84006ODN

ALL SAMPLES ARE FROM MONITORING LOCATION EFF-001 WITH EXCEPTION OF THE THREE IN BOLD MARKED INF

FLOW MGD	INF TOTAL AMMONIA mg/L	ONE SAMPLE PER MONTH REQUIRED					
		TOTAL AMMONIA mg/L	TOTAL COPPER mg/L	TOTAL COPPER ug/L	TOTAL NICKEL mg/L	TOTAL NICKEL ug/L	GREASE & OIL mg/L
0.887	29.4	14.7					
0.923							
0.893							
0.796							
0.891	31.5	11.6					
0.907		16.3	0.012	12	0.0063	6.3	9.5
0.967							
0.912	30.8	20.7					
0.808							
0.904							
0.835							
0.809	34.4	20.8					
0.860							
0.828							
0.818	34.0	16.1					
0.894							
0.889							
0.806							
0.852	34.90	19.0					
0.840							
0.988							
0.974	30.6	24.2					
1.176							
0.942							
0.954							
0.920	29.7	18.8					
1.151							
1.163							
1.159	26.5	13.6					
1.094							
27.84							

0.928	31.3	17.6	0.012	12.0	0.006	6.3	9.50
0.796	26.5	11.6	0.012	12.0	0.006	6.3	9.50
1.176	34.9	24.2	0.012	12.0	0.006	6.3	9.50

NA = NOT ANALYZED

Units	METHOD USED	Daily Max	Avg. Monthly	Avg. Wkly	Inst. Max
ug/L	EPA 200.7	300			1500.000
ug/L	EPA 200.7	600			
mg/L	EPA 1664		25	40	75.0

CITY OF CRESCENT CITY WPCF - SUMMARY OF TREATMENT REPORT

CITY OF C

DISCHARGE MONITORING - PERMIT No. CA0022756

ORDER # R1-2017-0002 ID # 1A84006ODN

Dec. 2018

Dec. 2018

ALL SAMPLES ARE FROM MONITORING LOCATION EFF-001 WITH EXCEPTION OF THE THREE IN BOLD MARKED INF

DAY	DAILY REQUIREMENTS						WEEKLY REQUIREMENTS												DAY	RAIN IN			
	RAIN IN	INF FLOW MGD	FLOW MGD	pH	TOTAL CL ₂ mg/L	Settleable Solids		SUSPENDED SOLIDS					BOD 5					FECAL MPN			TURB NTU	TURB Wkly Avg	
						EFF	Wkly Avg(mg/L)	INF mg/L	EFF mg/L	Wkly Avg (mg/L)	LBS/DAY	Wkly Avg(lb/day)	INF mg/L	EFF mg/L	Wkly Avg(mg/L)	LBS/DAY	Wkly Avg(lb/day)						
1	0.20	1.255	1.128	7.52	<0.05	<0.1				x		x			x		x	4.5	6.3	x	1	0.20	
2	0.00	1.190	1.043	7.46	<0.05	<0.1	<0.1			8.7		70			16.3		129		7.7	7.2	2	0.00	
3	0.01	1.116	0.965	7.60	<0.05	<0.1		264	9.9			80			337	17.0		137		<1.8	8.6	3	0.01
4	0.00	1.103	1.020	7.49	<0.05	0.1													7.1		4	0.00	
5	0.00	1.090	0.978	7.49	<0.05	<0.1		175	7.9			64			216	14.6		119		7.4		5	0.00
6	0.00	1.067	0.923	7.40	<0.05	<0.1		189	8.4			65			241	17.2		132		7		6	0.00
7	0.17	1.044	0.930	7.44	<0.05	<0.1													6.5		7	0.17	
8	0.01	1.070	1.002	7.40	<0.05	<0.1												17.0	6.1		8	0.01	
9	0.90	1.171	1.053	7.33	<0.05	<0.1	<0.1			10.4		91			17.2		154		6.2	6.7	9	0.90	
10	0.01	1.054	1.172	7.39	<0.05	<0.1												2.0	7.1		10	0.01	
11	0.56	1.150	1.093	7.48	<0.05	<0.1													7.4		11	0.56	
12	0.01	1.193	1.065	7.40	<0.05	<0.1		207	9.1			81			254	16.4		146		4.0	7	12	0.01
13	0.00	1.138	1.048	7.50	<0.05	<0.1		202	11.6			101			274	19.7		172			7.6	13	0.00
14	0.53	1.199	1.089	7.37	<0.05	<0.1														7.3		14	0.53
15	0.15	1.163	1.108	7.22	<0.05	<0.1									205	15.5		143		2.0	4	15	0.15
16	1.07	1.372	1.276	7.33	<0.05	<0.1	<0.1			13.7		147			20.1		214		4.3	5.1	16	1.07	
17	0.19	1.327	1.199	7.32	<0.05	<0.1		195	11.2			112			195	18.8		188		6.8	3.2	17	0.19
18	0.66	1.437	1.373	7.56	<0.05	<0.1													6.7		18	0.66	
19	0.09	1.340	1.258	7.34	<0.05	<0.1		173	13.8			145			173	20.1		211		<1.8	5.6	19	0.09
20	2.15	2.020	1.760	7.57	<0.05	<0.1														7.2		20	2.15
21	0.02	1.651	1.366	7.34	<0.05	<0.1		134	16.2			185			169	21.3		243			4.7	21	0.02
22	0.12	1.395	1.223	7.46	<0.05	<0.1													4		22	0.12	
23	0.40	1.317	1.061	7.30	<0.05	<0.1	<0.1			6.2		66			10.7				4.2	4.5	23	0.40	
24	0.81	1.371	1.647	7.43	<0.05	<0.1		168	7.2			99			198	11.4		157			4.8	24	0.81
25	0.03	1.428	1.154	7.33	<0.05	<0.1													3.9		25	0.03	
26	0.05	1.565	1.075	7.38	<0.05	<0.1		339	4.9			44			383	10.0		90		2.0	4	26	0.05
27	0.01	1.446	1.059	7.29	<0.05	<0.1		192	6.4			57			252	10.7		95			4.6	27	0.01
28	0.00	1.204	1.021	7.35	<0.05	<0.1													5.3		28	0.00	
29	0.15	1.197	0.957	7.29	<0.05	<0.1													5		29	0.15	
30	0.20	1.225	1.005	7.35	<0.05	<0.1	x			x		x			x		x		5.7	x	30	0.20	
31	0.00	1.171	0.934	7.31	<0.05	<0.1		180	8.1			63			224	13.5		105		<1.8	4.9	31	0.00
TOTAL	8.50	39.47	34.99																			TOTAL	8.50

(MEDIAN)

AVG	0.27	1.273	1.129	7.40	<0.05	<0.1		202	9.6			91			240	15.9		149		2	5.9		AVG	0.27
MIN	0.00	1.044	0.923	7.22	<0.05	<0.1		134	4.9			44			169	10.0		89.7		<1.8	3.2		MIN	0.00
MAX	2.15	2.02	1.76	7.60	<0.05	0.10	<0.1	339	16.2	13.7		185		147	383	21.3	20.1	243	214	17	8.6	7.2	MAX	2.15

DISCHARGE LIMITS:																								
INSTANT MAX.				1.8	3															225			ND = NON DETECTED	
DAILY MAX.				0.24																				
7 DAY AVG.					1.5				45			700			45					100				
30 DAY AVG.					1				30			465			30					14	75			ANALYTE
DAILY MAX. OF 10%							1													43				TOTAL COPPER
pH				6.0/9.0																				TOTAL NICKEL
SIX MONTH MEDIAN				0.06																				GREASE & OIL

TOTAL RAINFALL (year-to-date): 56.27

TSS 85% REMOVAL		BOD 75% REMOVAL	
TSS 95.26	BOD 93.39	CALCULATED % REMOVALS	

RESCENT CITY WPCF - SUMMARY OF TREATMENT REPORT

DISCHARGE MONITORING - PERMIT No. CA0022756

ORDER # R1-2017-0002 ID # 1A84006ODN

ALL SAMPLES ARE FROM MONITORING LOCATION EFF-001 WITH EXCEPTION OF THE THREE IN BOLD MARKED INF

FLOW MGD	INF TOTAL AMMONIA mg/L	ONE SAMPLE PER MONTH REQUIRED					GREASE & OIL mg/L
		TOTAL AMMONIA mg/L	TOTAL COPPER mg/L	TOTAL COPPER ug/L	TOTAL NICKEL mg/L	TOTAL NICKEL ug/L	
1.128							
1.043							
0.965	25.9	15.4					
1.020							
0.978							
0.923	27.9	16.6					
0.930							
1.002							
1.053							
1.172							
1.093			0.011	11	0.0089	8.900	ND<5.3
1.065	29.2	19.4					
1.048	28.8	13.4					
1.089							
1.108							
1.276							
1.199	22.7	11.5					
1.373							
1.258							
1.760							
1.366	13.5	6.6					
1.223							
1.061							
1.647	21.3	7.2					
1.154							
1.075							
1.059	22.7	6					
1.021							
0.957							
1.005							
0.934	24.7	11.3					
34.99							

1.129	24.1	11.9	0.011	11.0	0.0089	8.9	ND
0.923	13.5	6.0	0.011	11.0	0.0089	8.9	ND
1.760	29.2	19.4	0.011	11.0	0.0089	8.9	ND

NA = NOT ANALYZED

Units	METHOD USED	Daily Max	Avg. Monthly	Avg. Wkly	Inst. Max
ug/L	EPA 200.7	300			1500.000
ug/L	EPA 200.7	600			
mg/L	EPA 1664		25	40	75.0

CITY OF CRESCENT CITY WPCF - SUMMARY OF TREATMENT REPORT
 DISCHARGE MONITORING - PERMIT No. CA0022756
 ORDER # R1-2017-0002 ID # 1A84006ODN

Jan. 2019

ALL SAMPLES ARE FROM MONITORING LOCATION EFF-001 WITH EXCEPTION OF THE THREE IN BOLD MARKED INF

CITY OF CRESCENT CITY WPCF - SUMMARY OF TREATMENT REPORT
 DISCHARGE MONITORING - PERMIT No. CA0022756
 ORDER # R1-2017-0002 ID # 1A84006ODN

Jan. 2019

ALL SAMPLES ARE FROM MONITORING LOCATION EFF-001 WITH EXCEPTION OF THE THREE IN BOLD MARKED INF

DAY	DAILY REQUIREMENTS														WEEKLY REQUIREMENTS										ONE SAMPLE PER MONTH REQUIRED						
	RAIN IN	INF FLOW MGD	FLOW MGD	pH	TOTAL CL ₂ mg/L	Settleable Solids		SUSPENDED SOLIDS					BOD 5					FECAL MPN	TURB NTU	TURB Wkly Avg	DAY	RAIN IN	FLOW MGD	INF TOTAL AMMONIA mg/L	TOTAL AMMONIA mg/L	TOTAL COPPER mg/L	TOTAL COPPER ug/L	TOTAL NICKEL mg/L	TOTAL NICKEL ug/L	GREASE & OIL mg/L	
						EFF	Wkly Avg(mg/L)	INF mg/L	EFF mg/L	Wkly Avg (mg/L)	LBS/DAY	Wkly Avg(lb/day)	INF mg/L	EFF mg/L	Wkly Avg(mg/L)	LBS/DAY	Wkly Avg(lb/day)														INF mg/L
30		1.225	1.005	7.35		<0.1	<0.1												30	0.00	1.005										
31		1.171	0.934	7.31		<0.1													31	0.00	0.934										
1	0.00	1.193	0.928	7.42	<0.05	<0.1													1	0.00	0.928										
2	0.00	1.141	0.926	7.23	<0.05	<0.1													2	0.00	0.926										
3	0.00	1.120	0.922	7.41	3.45	<0.1													3	0.00	0.922	25.7	12.3								
4	0.10	1.117	0.909	7.33	<0.05	<0.1													4	0.10	0.909										
5	0.70	1.134	0.902	7.39	<0.05	<0.1													5	0.70	0.902										
6	0.59	1.392	1.140	7.41	<0.05	<0.1	<0.1												6	0.59	1.140										
7	0.23	1.341	1.121	7.45	<0.05	<0.1													7	0.23	1.121	20.8	8.9								
8	0.58	1.435	1.198	7.36	<0.05	<0.1													8	0.58	1.198										
9	0.37	1.585	1.323	7.29	<0.05	<0.1													9	0.37	1.323										
10	0.70	1.496	1.213	7.35	<0.05	<0.1													10	0.70	1.213	18.8	10.2								
11	0.10	1.369	1.141	7.39	<0.05	<0.1													11	0.10	1.141										
12	0.01	1.294	1.110	7.36	<0.05	<0.1													12	0.01	1.110										
13	0.00	1.281	1.056	7.30	<0.05	<0.1	<0.1												13	0.00	1.056										
14	0.12	1.245	1.025	7.32	<0.05	<0.1													14	0.12	1.025	24.0	10.1								
15	0.14	1.241	1.059	7.35	<0.05	<0.1													15	0.14	1.059			0.012	12.0	0.012	12.0		ND<6.2		
16	0.64	1.306	1.126	7.45	<0.05	<0.1													16	0.64	1.126										
17	0.85	1.564	1.291	7.40	<0.05	<0.1													17	0.85	1.291	21.8	13.8								
18	1.55	1.761	1.404	7.36	<0.05	<0.1													18	1.55	1.404										
19	4.70	3.582	2.954	7.27	<0.05	0.1													19	4.70	2.954										
20	0.53	4.299	3.753	7.07	<0.05	<0.1	<0.1												20	0.53	3.753										
21	0.02	2.936	2.448	7.21	<0.05	<0.1													21	0.02	2.448										
22	0.02	2.331	1.956	7.20	<0.05	<0.1													22	0.02	1.956										
23	0.03	2.081	1.762	7.27	<0.05	<0.1													23	0.03	1.762	10.8	6.3								
24	0.01	1.950	1.605	7.26	<0.05	<0.1													24	0.01	1.605	12.0	8.3								
25	0.00	1.828	1.606	7.26	<0.05	<0.1													25	0.00	1.606										
26	0.00	1.759	1.444	7.34	<0.05	<0.1													26	0.00	1.444										
27	0.00	1.674	1.388	7.24	<0.05	<0.1	<0.1												27	0.00	1.388										
28	0.00	1.593	1.355	7.24	<0.05	<0.1													28	0.00	1.355										
29	0.00	1.566	1.287	7.32	<0.05	<0.1													29	0.00	1.287										
30	0.00	1.508	1.272	7.27	<0.05	<0.1													30	0.00	1.272	17.7	7								
31	0.11	1.485	1.209	7.26	<0.05	<0.1													31	0.11	1.209	18.9	12.4								
1						0.1													1												
2						<0.1													2												
TOTAL	12.10	52.61	43.83																TOTAL	12.10	43.83										
Monthly														(MEDIAN)																	
AVG	0.39	1.70	1.41	7.32	0.16	<0.1	<0.1	179	7.3	7.18	75	74	229	14.6	14.1	146.5	143	4.5	5.5	AVG	0.39	1.414	18.9	9.9	0.0120	12.0	0.0120	12	ND<5.8		
MIN	0.00	1.12	0.90	7.07	<0.05	<0.1	<0.1	120	4.7	5.1	50	52	154	10.3	10.8	109	109	2	3.8	MIN	0.00	0.902	10.8	6.3	0.0120	12.0	0.0120	12	ND<5.8		
MAX	4.70	4.30	3.75	7.45	3.45	0.10	<0.1	278	9.5	8.5	98	95	339	17.7	16.9	179	168	49	7.8	MAX	4.70	3.753	25.7	13.8	0.0120	12.0	0.0120	12	ND<5.8		
DISCHARGE LIMITS:														ND = NON DETECTED NA = NOT ANALYZED																	
INSTANT MAX.														225																	
DAILY MAX.														0.24																	
7 DAY AVG.														1.5																	
30 DAY AVG.														30																	
DAILY MAX. OF 10%														1																	
pH														6.09.0																	
SIX MONTH MEDIAN														0.06																	
TSS 85% REMOVAL														BOD 75% REMOVAL																	
TOTAL RAINFALL (year-to-date): 12.10														CALCULATED % REMOVALS																	
														TSS 95.9 BOD 93.6																	

CITY OF CRESCENT CITY WPCF - SUMMARY OF TREATMENT REPORT

C

DISCHARGE MONITORING - PERMIT No. CA0022756

ORDER # R1-2017-0002 ID # 1A84006ODN

Feb. 2019

Feb. 2019

ALL SAMPLES ARE FROM MONITORING LOCATION EFF-001 WITH EXCEPTION OF THE THREE IN BOLD MARKED INF

DAY	DAILY REQUIREMENTS						WEEKLY REQUIREMENTS													DAY			
	RAIN IN	INF FLOW MGD	FLOW MGD	pH	TOTAL CL ₂ mg/L	Settleable Solids		SUSPENDED SOLIDS					BOD 5					FECAL MPN	TURB NTU		TURB Wkly Avg		
						EFF	Wkly Avg(mg/L)	INF mg/L	EFF mg/L	Wkly Avg (mg/L)	LBS/DAY	Wkly Avg(lb/day)	INF mg/L	EFF mg/L	Wkly Avg(mg/L)	LBS/DAY	Wkly Avg(lb/day)						
1	0.73	1.577	1.316	7.41	<0.05	0.1	x			x		x			x		x			4.5	4.5	x	1
2	0.18	1.731	1.462	7.32	<0.05	<0.1														4.5	4.8		2
3	0.71	1.718	1.408	7.23	<0.05	<0.1	<0.1			6.2		76			10.9		135			4.3	4.5		3
4	0.540	2.010	1.644	7.22	<0.05	<0.1		115	6.4		88			124	11.4		156			4.5	4.2		4
5	0.190	1.870	1.540	7.33	<0.05	<0.1														4.7			5
6	0.020	1.761	1.435	7.22	<0.05	<0.1		163	6.4		77			175	10.7		128			2.0	4.6		6
7	0.010	1.685	1.366	7.22	<0.05	<0.1		182	5.7		65			166	10.7		122				4.3		7
8	0.450	1.588	1.315	7.30	<0.05	<0.1															4.8		8
9	0.540	1.730	1.452	7.24	<0.05	0.1													<1.8		4.7		9
10	0.230	1.852	1.491	7.26	<0.05	<0.1	<0.1			7.6		135			14.0		249			4.0	5.2	5.2	10
11	0.16	1.773	1.479	7.25	<0.05	<0.1		237	6.6		81			196	12.8		158			4.0	5.1		11
12	1.30	7.804	1.477	7.16	<0.05	<0.1															5		12
13	1.44	2.550	2.145	7.17	<0.05	<0.1		144	8.0		143			138	13.0		233			6.8	6.8		13
14	0.97	3.227	2.641	7.20	<0.05	<0.1		112	8.2		181			112	16.2		357				5.9		14
15	1.20	3.266	2.797	7.13	<0.05	<0.1															4.2		15
16	0.41	3.151	2.647	7.29	<0.05	<0.1													<1.8		4.4		16
17	0.00	2.822	2.327	7.21	<0.05	0.1	<0.1			6.6		102			11.8		183				4.4	4.4	17
18	0.10	2.446	2.018	7.27	<0.05	<0.1		91.8	6.7		113			89.8	11.2		188			2.0	4		18
19	0.42	2.240	1.827	7.53	<0.05	<0.1															5.3		19
20	0.22	2.545	2.121	7.22	<0.05	<0.1		131	6.2		110			131	11.8		209			2.0	5		20
21	0.01	2.246	1.472	7.29	<0.05	<0.1		114	6.8		83			131	12.4		152				3.8		21
22	0.01	2.040	1.668	7.20	<0.05	<0.1															4.5		22
23	1.80	2.125	1.744	7.30	<0.05	<0.1															3.7		23
24	4.35	3.796	4.791	7.22	<0.05	<0.1	<0.1			12.6		437			17.2		583				5.7	5.5	24
25	2.44	7.917	5.164	7.02	<0.05	0.1		142	15.1		650			87.1	19.2		827				8.9		25
26	1.30	5.507	3.601	7.07	<0.05	<0.1															4.2		26
27	0.20	5.509	3.621	7.08	<0.05	<0.1													13.0		4.6		27
28	0.20	4.264	2.679	7.15	<0.05	<0.1		135	10.0		223			142	15.2		340				6.5		28
1						<0.1															4.9		1
2						<0.1															3.9		2
TOTAL	20.13	82.75	60.65																				TOTAL

(MEDIAN)

AVG	0.72	2.955	2.166	7.23	<0.05	<0.1	<0.1	142	7.8	8.2	165	188	136	13.1	13.5	261	287.73	3.0	4.9	4.9	AVG
MIN	0.00	1.577	1.315	7.02	<0.05	<0.1	<0.1	91.8	5.7	6.2	64.9	76.4	87.1	10.7	10.9	122	135.42	<1.8	3.7	4.4	MIN
MAX	4.35	7.917	5.164	7.53	<0.05	0.1	0.1	237	15.1	12.6	650	437	196	19.2	17.2	827	583.26	13	8.9	5.5	MAX

DISCHARGE LIMITS:																					
INSTANT MAX.					1.8	3														225	ND = NON DET
DAILY MAX.					0.24																
7 DAY AVG.						1.5			45		700			45						100	
30 DAY AVG.						1			30		465			30					14	75	ANALYTE
DAILY MAX. OF 10%								1											43		TOTAL COPPER
pH				6.0/9.0																	TOTAL NICKEL
SIX MONTH MEDIAN					0.06																GREASE & OIL
											TSS 85% REMOVAL					BOD 75% REMOVAL					

TOTAL RAINFALL (year-to-date):	32.23	CALCULATED % REMOVALS	
		TSS 94.50	BOD 90.31

ITY OF CRESCENT CITY WPCF - SUMMARY OF TREATMENT REPORT

DISCHARGE MONITORING - PERMIT No. CA0022756

ORDER # R1-2017-0002 ID # 1A84006ODN

ALL SAMPLES ARE FROM MONITORING LOCATION EFF-001 WITH EXCEPTION OF THE
THREE IN BOLD MARKED INF

RAIN IN	FLOW MGD	INF TOTAL AMMONIA mg/L	ONE SAMPLE PER MONTH REQUIRED					GREASE & OIL mg/L
			TOTAL AMMONIA mg/L	TOTAL COPPER mg/L	TOTAL COPPER ug/L	TOTAL NICKEL mg/L	TOTAL NICKEL ug/L	
0.73	1.316							
0.18	1.462							
0.71	1.408							
0.54	1.644	12.5	6.4					
0.19	1.540		4.8	0.011	11.000	0.011	11	ND<5.8
0.02	1.435							
0.01	1.366	15.0	6.7					
0.45	1.315							
0.54	1.452							
0.23	1.491							
0.16	1.479	15.0	5.6					
1.30	1.477							
1.44	2.145							
0.97	2.641	9.6	7.3					
1.20	2.797							
0.41	2.647							
0.00	2.327							
0.10	2.018	9.7	3.5					
0.42	1.827							
0.22	2.121							
0.01	1.472	9.1	5.8					
0.01	1.668							
1.80	1.744							
4.35	4.791							
2.44	5.164	4.4	2.7					
1.30	3.601							
0.20	3.621							
0.20	2.679	4.4	2.5					
20.13	60.65							

0.72	2.17	10.0	5.0	0.011	11.0	0.011	11.0	ND<5.8
0.00	1.32	4.4	2.5	0.011	11.0	0.011	11.0	ND<5.8
4.35	5.16	15.0	7.3	0.011	11.0	0.011	11.0	ND<5.8

ECTED

NA = NOT ANALYZED

Units	METHOD USED	Daily Max	Avg. Monthly	Avg. Wkly	Inst. Max
ug/L	EPA 200.7	300			1500.000
ug/L	EPA 200.7	600			
mg/L	EPA 1664		25	40	75.0

CITY OF CRESCENT CITY WPCF - SUMMARY OF TREATMENT REPORT

CITY OF C

DISCHARGE MONITORING - PERMIT No. CA0022756

ORDER # R1-2017-0002 ID # 1A84006ODN

Mar-19

Mar-19

ALL SAMPLES ARE FROM MONITORING LOCATION EFF-001 WITH EXCEPTION OF THE THREE IN BOLD MARKED INF

DAY	DAILY REQUIREMENTS						WEEKLY REQUIREMENTS													DAY	RAIN IN	
	RAIN IN	INF FLOW MGD	FLOW MGD	pH	TOTAL CL ₂ mg/L	Settleable Solids		SUSPENDED SOLIDS					BOD 5					FECAL MPN	TURB NTU			TURB Wkly Avg
						EFF	Wkly Avg(mg/L)	INF mg/L	EFF mg/L	Wkly Avg (mg/L)	LBS/DAY	Wkly Avg(lb/day)	INF mg/L	EFF mg/L	Wkly Avg(mg/L)	LBS/DAY	Wkly Avg(lb/day)					
1	0.13	3.842	2.359	7.07	<0.05	<0.1	x	61.8	7.9	x	155	x	63	13.0	x	256	x	2.0	4.9		1	0.13
2	0.01	3.503	2.085	7.28	<0.05	<0.1												2.0	3.9		2	0.01
3	0.00	2.879	1.769	7.11	<0.05	<0.1	<0.1			7.1					13.5		178		4.2	4.7	3	0.00
4	0.00	2.515	1.501	7.08	<0.05	<0.1		153	6.9		86		137	14.4		180			4.9		4	0.00
5	0.63	2.485	1.526	7.27	<0.05	<0.1												<1.8	5.4		5	0.63
6	0.70	2.695	1.788	7.05	<0.05	0.1		105	7.0		104		114	15.0		224		<1.8	5.6		6	0.70
7	0.02	2.437	1.422	7.10	<0.05	<0.1													4.4		7	0.02
8	0.00	2.256	1.405	7.25	<0.05	<0.1		87.6	7.4		87		109	11.2		131			4		8	0.00
9	0.00	2.164	1.282	7.33	<0.05	<0.1												<1.8	4.6		9	0.00
10	0.00	2.041	1.124	7.29	<0.05	<0.1	<0.1			7.8		68			16.5		143		4.5	5.7	10	0.00
11	0.32	1.951	1.043	7.07	<0.05	<0.1		137	7.7		67		195	17.0		148			6.8		11	0.32
12	0.06	2.021	1.208	7.16	<0.05	0.1												4.5	7.2		12	0.06
13	0.00	1.923	1.016	7.21	<0.05	<0.1												2.0	6.2		13	0.00
14	0.00	1.828	1.042	7.16	<0.05	<0.1		132	7.9		69		149	15.9		138			6.1		14	0.00
15	0.00	1.769	0.965	7.30	<0.05	0.1													4.6		15	0.00
16	0.00	1.719	0.880	7.24	<0.05	<0.1												<1.8	4.7		16	0.00
17	0.00	1.638	0.889	7.13	<0.05	<0.1	<0.1			8.3		57			15.9		110		4.1	4.8	17	0.00
18	0.00	1.660	0.857	7.20	<0.05	<0.1		146	9.4		67		160	17.1		122			4.6		18	0.00
19	0.01	1.664	0.884	7.15	<0.05	<0.1												<1.8	5		19	0.01
20	0.05	1.604	0.829	7.23	<0.05	<0.1		160	8.0		55		184	15.3		106		2.0	5.1		20	0.05
21	0.04	1.565	0.788	7.23	<0.05	<0.1		149	7.4		49		168	15.3		101			4.8		21	0.04
22	0.86	1.724	0.940	7.29	<0.05	<0.1													5.9		22	0.86
23	0.01	1.668	0.862	7.28	<0.05	<0.1													4.1		23	0.01
24	0.23	1.609	0.729	7.22	<0.05	<0.1	<0.1			7.4		65			16.1		141		5.1	5.3	24	0.23
25	0.61	1.861	0.992	7.31	<0.05	<0.1		152	7.9		65		164	17.7		146			4.8		25	0.61
26	0.60	1.775	0.890	7.20	<0.05	<0.1												<1.8	5.6		26	0.60
27	0.96	1.868	0.970	7.23	<0.05	<0.1		134	7.3		59		180	15.0		121			4.6		27	0.96
28	0.87	2.149	1.193	7.31	<0.05	<0.1		174	7.1		71		158	15.6		155			5.9		28	0.87
29	0.12	2.228	1.272	7.33	<0.05	<0.1													6.5		29	0.12
30	0.01	2.035	1.091	7.35	<0.05	<0.1													4.7		30	0.01
31	0.12	1.935	1.001	7.27	<0.05	<0.1				x		x			x		x		4		31	0.12
TOTAL	6.36	65.01	36.6																		TOTAL	6.36

Effluent Flow meter needed calibration from 3/3/19-3/9/19-Estimated flow

3/26/19 Rainfall taken from Ranney data, WWTP left blank

(MEDIAN)

AVG	0.21	2.097	1.181	7.22	<0.05	<0.1	<0.1	133	7.7	7.7	78	71	148	15.2	15.5	152	143	<1.8	5.1	5.1	AVG	0.21
MIN	0.00	1.565	0.729	7.05	<0.05	<0.1	<0.1	62	6.9	7.1	49	57	63	11.2	13.5	101	110	<1.8	3.9	4.7	MIN	0.00
MAX	0.96	3.84	2.36	7.35	<0.05	0.1	<0.1	174	9.4	8.3	155	92	195	17.7	16.5	256	178	4.5	7.2	5.7	MAX	0.96

DISCHARGE LIMITS:																					
INSTANT MAX.				1.8		3													225	ND = NON DETECTED	
DAILY MAX.				0.24																	
7 DAY AVG.						1.5			45		700			45					100		
30 DAY AVG.						1			30		465			30				14	75		
DAILY MAX. OF 10%							1											43		ANALYTE	
pH				6.0/9.0																	TOTAL COPPER
SIX MONTH MEDIAN				0.06																	TOTAL NICKEL
																					GREASE & OIL

TOTAL RAINFALL (year-to-date): 38.59

TSS 85% REMOVAL		BOD 75% REMOVAL	
TSS	94.23	BOD	89.75

CALCULATED % REMOVALS

RESCENT CITY WPCF - SUMMARY OF TREATMENT REPORT

DISCHARGE MONITORING - PERMIT No. CA0022756

ORDER # R1-2017-0002 ID # 1A84006ODN

ALL SAMPLES ARE FROM MONITORING LOCATION EFF-001 WITH EXCEPTION OF THE
THREE IN BOLD MARKED INF

FLOW MGD	INF TOTAL AMMONIA mg/L	ONE SAMPLE PER MONTH REQUIRED					
		TOTAL AMMONIA mg/L	TOTAL COPPER mg/L	TOTAL COPPER ug/L	TOTAL NICKEL mg/L	TOTAL NICKEL ug/L	GREASE & OIL mg/L
2.359	6.0	4.3					
2.085							
1.769							
1.501	7.4	6.6					
1.526							
1.788							
1.422	9.5						
1.405	12.0	8.5					
1.282							
1.124							
1.043	13.0	6.1					
1.208			0.011	11	0.016	16.0	ND<5.7
1.016							
1.042	13.0	6.4					
0.965							
0.880							
0.889							
0.857	12.0	7.2					
0.884							
0.829							
0.788	16.0	6.3					
0.940							
0.862							
0.729							
0.992	14	5.8					
0.890							
0.970							
1.193	11.0	5.3					
1.272							
1.091							
1.001							
36.6							

1.181	11.4	6.3	0.011	11.0	0.016	16.0	ND<5.7
0.729	6.0	4.3	0.011	11.0	0.016	16.0	ND<5.7
2.359	16.0	8.5	0.011	11.0	0.016	16.0	ND<5.7

NA = NOT ANALYZED

Units	METHOD USED	Daily Max	Avg. Monthly	Avg. Wkly	Inst. Max
ug/L	EPA 200.7	300			1500.000
ug/L	EPA 200.7	600			
mg/L	EPA 1664		25	40	75.0

CITY OF CRESCENT CITY WPCF - SUMMARY OF TREATMENT REPORT

CITY OF C

DISCHARGE MONITORING - PERMIT No. CA0022756

ORDER # R1-2017-0002 ID # 1A84006ODN

Apr-19

Apr-19

ALL SAMPLES ARE FROM MONITORING LOCATION EFF-001 WITH EXCEPTION OF THE THREE IN BOLD MARKED INF

DAY	DAILY REQUIREMENTS					WEEKLY REQUIREMENTS															DAY	RAIN IN		
	RAIN IN	INF FLOW MGD	FLOW MGD	pH	TOTAL CL ₂ mg/L	Settleable Solids		SUSPENDED SOLIDS					BOD 5					FECAL MPN	TURB NTU	TURB Wkly Avg				
						EFF	Wkly Avg(mg/L)	INF mg/L	EFF mg/L	Wkly Avg (mg/L)	LBS/DAY	Wkly Avg(lb/day)	INF mg/L	EFF mg/L	Wkly Avg(mg/L)	LBS/DAY	Wkly Avg(lb/day)							
31						<0.1	<0.1			10.1		131			18.4		229		4		31	0.00		
1	0.31	1.921	1.029	7.26	<0.05	<0.1												4.6	5.3	1	0.31			
2	0.50	1.929	1.041	7.33	<0.05	<0.1											2.0	5.6	2	0.50				
3	0.34	0.972	1.902	7.37	<0.05	<0.1		146	11.8		187			151	18.3		290	6.8	4.9	3	0.34			
4	0.51	1.857	1.956	7.38	<0.05	<0.1		124										6		4	0.51			
5	0.59	2.165	1.085	7.39	<0.05	0.1		135	8.3		75			135	18.5		167		5.8	5	0.59			
6	1.15	2.203	1.251	7.37	<0.05	<0.1											2.0	6.3	6	1.15				
7	3.50	4.344	2.935	7.30	<0.05	<0.1	<0.1			9.5		317			14.1		450		6.9	4.9	7	3.50		
8	1.95	6.821	5.192	7.16	<0.05	<0.1		188	14.8		641			166	19.2		831	7.8	7.3	8	1.95			
9	0.03	4.837	3.706	7.27	<0.05	<0.1												4.4		9	0.03			
10	0.00	3.786	2.904	7.25	<0.05	<0.1		35.6	7.2		174			62.7	11.9		288	7.8	3.8	10	0.00			
11	0.38	3.536	2.699	7.27	<0.05	<0.1												4		11	0.38			
12	0.01	3.226	2.463	7.29	<0.05	<0.1		90.9	6.6		136			84.6	11.2		230		3.6	12	0.01			
13	0.08	2.921	2.179	7.25	<0.05	<0.1												<1.8	4.3	13	0.08			
14	0.01	2.570	2.060	7.26	<0.05	<0.1	<0.1			6.7		96			15.1		218		4.9	5.9	14	0.01		
15	0.30	2.424	1.984	7.27	<0.05	<0.1		53.7	5.9		98			63.3	12.2		202	<1.8	5.1	15	0.30			
16	0.00	2.323	1.880	7.30	<0.05	<0.1													4.8		16	0.00		
17	0.00	2.184	1.759	7.32	<0.05	<0.1		219	6.7		98			189	15.4		226	1.8	6.5	17	0.00			
18	0.00	2.104	1.667	7.34	<0.05	<0.1		197	6.5		90			148	14.9		207		6.7	18	0.00			
19	0.02	2.020	1.733	7.52	<0.05	<0.1													6.7	19	0.02			
20	0.00	1.938	1.587	7.37	<0.05	<0.1		164	7.5		99			145	17.8		236		6.3	20	0.00			
21	0.00	1.814	1.431	7.30	<0.05	<0.1	<0.1			5.6		63			16.7		187		7	7.5	21	0.00		
22	0.00	1.766	1.388	7.28	<0.05	<0.1		145	5.6		65			135	16.5		191	2.0	6.8	22	0.00			
23	0.00	1.744	1.406	7.29	<0.05	<0.1													6.9	23	0.00			
24	0.00	1.700	1.355	7.30	<0.05	<0.1		140	5.6		63			143	16.5		186		7.4	24	0.00			
25	0.00	1.637	1.293	7.29	<0.05	<0.1		170	5.7		61			174	17.0		183		8.5	25	0.00			
26	0.00	1.568	1.282	7.36	<0.05	<0.1													8	26	0.00			
27	0.00	1.524	1.240	7.30	<0.05	<0.1													7.8	27	0.00			
28	0.00	1.517	1.216	7.29	<0.05	<0.1	x			x		x			x		x		7.4	x	28	0.00		
29	0.00	1.511	1.222	7.24	<0.05	<0.1		241	5.1		52			210	17.4		177	<1.8	8	29	0.00			
30	0.00	1.451	1.198	7.31	<0.05	<0.1													7.9	30	0.00			
TOTAL	9.68	72.31	56.04																		TOTAL	9.68		
Rainfall taken from Ranney, WW log= blank								Grab	all INF-C samples arrived >6°C					Grab										
Monthly	Needs Calibration							low volume														(MEDIAN)		
AVG	0.32	2.41	1.87	7.31	<0.05	<0.1	<0.1	146	7.5	7.3	142	159	139	15.9	15.3	263	285	2	6.1	5.9	AVG	0.32		
MIN	0.00	0.97	1.03	7.16	<0.05	<0.1	<0.1	35.6	5.1	5.6	52.0	63.2	62.7	11.2	14.1	167	187	<1.8	3.6	4.9	MIN	0.00		
MAX	3.50	6.82	5.19	7.52	<0.05	0.10	<0.1	241	14.8	9.5	641	317	210	19.2	16.7	831	450	7.8	8.5	7.5	MAX	3.50		
DISCHARGE LIMITS:																								
INSTANT MAX.					1.8	3													225	ND = NON DETECTED				
DAILY MAX.					0.24																			
7 DAY AVG.						1.5			45		700			45					100					
30 DAY AVG.						1			30		465			30				14	75					
DAILY MAX. OF 10%							1											43						
pH					6.0/9.0																			
SIX MONTH MEDIAN					0.06																			
										TSS 85% REMOVAL					BOD 75% REMOVAL									
TOTAL RAINFALL (year-to-date):										48.27		CALCULATED % REMOVALS												
										TSS 94.89		BOD 88.55												

RESCENT CITY WPCF - SUMMARY OF TREATMENT REPORT

DISCHARGE MONITORING - PERMIT No. CA0022756

ORDER # R1-2017-0002 ID # 1A84006ODN

ALL SAMPLES ARE FROM MONITORING LOCATION EFF-001 WITH EXCEPTION OF THE THREE IN BOLD MARKED INF

FLOW MGD	INF TOTAL AMMONIA mg/L	ONE SAMPLE PER MONTH REQUIRED					GREASE & OIL mg/L
		TOTAL AMMONIA mg/L	TOTAL COPPER mg/L	TOTAL COPPER ug/L	TOTAL NICKEL mg/L	TOTAL NICKEL ug/L	
0.000							
1.029							
1.041							
1.902	13.0	9.4					
1.956							
1.085	15.0	7.5					
1.251							
2.935							
5.192	5.3	4					
3.706							
2.904							
2.699							
2.463	8.3	3.6					
2.179							
2.060							
1.984							
1.880			0.0068	6.8	0.016	16.0	ND<5.1
1.759							
1.667	10.0	8.4					
1.733							
1.587	12.0	8.4					
1.431							
1.388	10.0	5.6					
1.406							
1.355							
1.293	15	5.9					
1.282							
1.240							
1.216							
1.222	15.0	7					
1.198							
56.04							

1.87	11.51	6.64	0.01	6.80	0.02	16.00	#DIV/0!
1.03	5.30	3.60	0.01	6.80	0.02	16.00	0.00
5.19	15.00	9.40	0.01	6.80	0.02	16.00	0.00

NA = NOT ANALYZED

Units	METHOD USED	Daily Max	Avg. Monthly	Avg. Wkly	Inst. Max
ug/L	EPA 200.7	300			1500.000
ug/L	EPA 200.7	600			
mg/L	EPA 1664		25	40	75.0

CITY OF CRESCENT CITY WPCF - SUMMARY OF TREATMENT REPORT

CITY OF C

DISCHARGE MONITORING - PERMIT No. CA0022756

ORDER # R1-2017-0002 ID # 1A84006ODN

May-19

May-19

ALL SAMPLES ARE FROM MONITORING LOCATION EFF-001 WITH EXCEPTION OF THE THREE IN BOLD MARKED INF

DAY	DAILY REQUIREMENTS						WEEKLY REQUIREMENTS											DAY	RAIN IN					
	RAIN IN	INF FLOW MGD	FLOW MGD	pH	Temp.	TOTAL CL ₂ mg/L	Settleable Solids		SUSPENDED SOLIDS					BOD 5						FECAL MPN	TURB NTU	TURB Wkly Avg		
							EFF	Wkly Avg(mg/L)	INF mg/L	EFF mg/L	Wkly Avg (mg/L)	LBS/DAY	Wkly Avg(lb/day)	INF mg/L	EFF mg/L	Wkly Avg(mg/L)	LBS/DAY						Wkly Avg(lb/day)	
28		1.517	1.216				<0.1	<0.1			5.6												28	
29		1.511	1.222				<0.1		241	5.1		52	53.2	210	17.4		177						29	
30		1.451	1.198				<0.1																30	
1	0.00	1.429	1.135	7.29	16.9	<0.05	<0.1		164	5.4		51		181	16.5		156		13.0	7.2			1	0.00
2	0.00	1.402	1.138	7.30	16.6	<0.05	<0.1														7.6		2	0.00
3	0.00	1.373	1.078	7.39	16.8	<0.05	<0.1		204	6.3		57		225	18.8		169			8.4			3	0.00
4	0.000	1.360	1.120	7.36	17.6	<0.05	<0.1											6.8	6.8				4	0.00
5	0.010	1.352	1.082	7.22	17.2	<0.05	<0.1	<0.1			5.2		48			18.9				6.6	6.9		5	0.01
6	0.000	1.355	1.085	7.21	17.2	<0.05	<0.1		202	6.0		54		207	19.9		180		4.0	7.5			6	0.00
7	0.000	1.364	1.120	7.33	17.1	<0.05	<0.1													7			7	0.00
8	0.000	1.352	1.101	7.28	17.5	<0.05	<0.1		231	4.8		44		256	18.7		172		2.0	7.7			8	0.00
9	0.000	1.337	1.103	7.30	17.7	<0.05	<0.1		194	4.8		44		228	18.0		166			7.8			9	0.00
10	0.000	1.277	1.065	7.31	17.5	<0.05	<0.1													6.5			10	0.00
11	0.00	1.234	0.995	7.14	17.8	<0.05	<0.1													5.3			11	0.00
12	0.00	1.214	0.976	7.22	18.0	<0.05	<0.1	<0.1			6.6		62			16.1		144		5.6	6.7		12	0.00
13	0.00	1.286	1.044	7.18	17.8	<0.05	<0.1		244	6.1		53		254	15.0		131			5.7			13	0.00
14	0.27	1.269	1.061	7.20	17.9	<0.05	0.1											2.0		6.5			14	0.27
15	0.56	1.338	1.140	7.36	18.2	<0.05	<0.1		313					349				<1.8		8.6			15	0.56
16	0.86	1.404	1.235	7.30	18.0	<0.05	<0.1		222	7.3		75								7			16	0.86
17	0.14	1.350	1.103	7.28	17.9	<0.05	<0.1													7.7			17	0.14
18	0.25	1.359	1.101	7.19	17.9	<0.05	<0.1		178	6.4		59		202	17.2		158		2.0	5.6			18	0.25
19	0.00	1.345	1.053	7.23	17.7	<0.05	<0.1	<0.1			7.5		74			18.7		175		5.8	6.9		19	0.00
20	1.00	1.336	1.081	7.28	17.9	<0.05	<0.1		202	6.2		56		238	17.6		159		2.0	6.3			20	1.00
21	0.01	1.651	1.363	7.43	17.2	<0.05	<0.1													8.3			21	0.01
22	0.00	1.539	1.284	7.32	17.5	<0.05	<0.1			9.3		100						2.0		7.4			22	0.00
23	0.00	1.437	1.164	7.41	17.9	<0.05	0.1		96.7	7.0		68		102	19.7		191			7.4			23	0.00
24	0.00	1.369	1.083	7.40	18.0	<0.05	<0.1													6.7			24	0.00
25	0.00	1.356	1.122	7.33	17.7	<0.05	0.1													6.1			25	0.00
26	0.14	1.350	1.084	7.40	17.5	<0.05	0.1	0.1			7.0		62			17.2		152		7.5	7.9		26	0.14
27	0.00	1.343	1.098	7.30	17.1	<0.05	<0.1		188.0	7.6		70		191	19.1		175		4.5	6.4			27	0.00
28	0.01	1.275	1.031	7.40	18.4	<0.05	0.1													9.2			28	0.01
29	0.02	1.280	1.033	7.25	18.4	<0.05	0.1			6.9		59			16.2		140			6.7			29	0.02
30	0.00	1.269	1.045	7.45	18.2	<0.05	0.1		178.0	6.5		57		185	16.3		142			7.9			30	0.00
31	0.00	1.229	1.056	7.47	18.4	<0.05	0.1													11			31	0.00
1							<0.1												7.8	6.5			1	
TOTAL	3.27	41.83	34.18																				TOTAL	3.27
Temp. Limit Exceeded																								
(MEDIAN)																								
AVG	0.11	1.35	1.103	7.31	17.7	<0.05	<0.1	<0.1	201	6	7	60	62	218	18	18	161	161	2.0	7.2	7.1	AVG	0.11	
MIN	0.00	1.21	0.976	7.14	16.6	<0.05	<0.1	<0.1	96.7	4.8	5.2	44.1	47.5	102.0	15.0	16.1	130.6	144.3	<1.8	5.3	6.7	MIN	0.00	
MAX	1.00	1.65	1.363	7.47	18.4	<0.05	0.1	0.1	313	9	8	100	74	349	20	19	191	175	13	11.0	7.9	MAX	1.00	
DISCHARGE LIMITS:																								
INSTANT MAX.					1.8		3														225	ND = NON DETECTED		
DAILY MAX.					0.24																			
7 DAY AVG.							1.5			45		700			45						100			
30 DAY AVG.							1			30		465			30						75			
DAILY MAX. OF 10%								1												43		ANALYTE		
pH				6.0@9.0																		TOTAL COPPER		
SIX MONTH MEDIAN					0.06																	TOTAL NICKEL		
																						GREASE & OIL		
TOTAL RAINFALL (year-to-date):						51.54	TSS 85% REMOVAL						BOD 75% REMOVAL											
							TSS 96.78						BOD 91.86											

RESCENT CITY WPCF - SUMMARY OF TREATMENT REPORT

DISCHARGE MONITORING - PERMIT No. CA0022756

ORDER # R1-2017-0002 ID # 1A84006ODN

ALL SAMPLES ARE FROM MONITORING LOCATION EFF-001 WITH EXCEPTION OF THE
THREE IN BOLD MARKED INF

FLOW MGD	INF TOTAL AMMONIA mg/L	ONE SAMPLE PER MONTH REQUIRED					GREASE & OIL mg/L
		TOTAL AMMONIA mg/L	TOTAL COPPER mg/L	TOTAL COPPER ug/L	TOTAL NICKEL mg/L	TOTAL NICKEL ug/L	
1.135	17.0	13					
1.138							
1.078							
1.120							
1.082							
1.085	20.0	9.8					
1.120			0.017	17	0.015	15	ND<5.5
1.101							
1.103	20.0	11.9					
1.065							
0.995							
0.976							
1.044	23.3	10.3					
1.061							
1.140							
1.235		15.4					
1.103							
1.101	20.0	14.2					
1.053							
1.081	20.6	9.8					
1.363							
1.284							
1.164	14.3	15.4					
1.083							
1.122							
1.084							
1.098	30.6	14.3					
1.031							
1.033							
1.045	22.2	12.7					
1.056							
34.18							

1.10	20.9	12.7	0.017	17.0	0.015	15.0	ND<5.8
0.98	14.3	9.8	0.017	17.0	0.015	15.0	ND<5.8
1.36	30.6	15.4	0.017	17.0	0.015	15.0	ND<5.8

NA = NOT ANALYZED

Units	METHOD USED	Daily Max	Avg. Monthly	Avg. Wkly	Inst. Max
ug/L	EPA 200.7	300			1500.000
ug/L	EPA 200.7	600			
mg/L	EPA 1664		25	40	75.0

CITY OF CRENSHAW CITY WPCF - SUMMARY REPORT

DISCHARGE MONITORING - PERMIT No. CA0022756

ORDER # R1-2017-0002 ID # 1A84006ODN

Jun-19

ALL SAMPLES ARE FROM MONITORING LOCATION EFF-001 WITH EXCEPTION OF THE THREE IN BOLD MARKED INF

DAY	DAILY REQUIREMENTS						WEEKLY REQUIREMENTS															
	RAIN IN	INF FLOW MGD	FLOW MGD	pH	Temp.	TOTAL CL ₂ mg/L	Settleable Solids		SUSPENDED SOLIDS					BOD 5			FECAL MPN	TURB NTU	TURB Wkly Avg			
							EFF	Wkly Avg(mg/L)	INF mg/L	EFF mg/L	Wkly Avg (mg/L)	LBS/DAY	Wkly Avg(lb/day)	INF mg/L	EFF mg/L	Wkly Avg(mg/L)				LBS/DAY	Wkly Avg(lb/day)	
1	0.00	1.142	0.849	7.42	18.5	<0.05	<0.1	x			x					x			7.8	6.5	x	
2	0.00	1.223	1.023	7.34	18.4	<0.05	0.1	0.2			12.5		102			22.5		182		4.9	7.2	
3	0.00	1.179	0.976	7.35	18.5	<0.05	0.1		355	14.2			116		303	23.7		193		2.0	7.2	
4	0.000	1.186	0.952	7.38	18.6	<0.05	0.5													6.7		
5	0.000	1.189	0.994	7.40	18.8	<0.05	0.1		198	10.3			85		241	20.7		172		2.0	7.4	
6	0.000	1.174	0.951	7.44	19.0	<0.05	0.4		262	13.1			104		279	23.0		182			9.4	
7	0.000	1.156	0.832	7.38	18.5	<0.05	0.3														7.2	
8	0.000	1.137	0.918	7.43	18.5	<0.05	0.2														7.7	
9	0.000	1.149	0.884	7.40	19.4	<0.05	0.1	0.3			9.2		73			18.9		149		7.6	7.6	
10	0.000	1.166	0.968	7.32	19.4	<0.05	0.1		222	11.1			90		262	18.9		153		2.0	8.5	
11	0.00	1.150	0.943	7.34	20.4	<0.05	0.5													8		
12	0.00	1.163	0.957	7.38	21.5	<0.05	0.2		208	8.8			70							13.0	7.5	
13	0.01	1.138	0.918	7.41	20.1	<0.05	0.2		226	7.8			60		270	18.9		145			7.1	
14	0.00	1.142	0.947	7.32	19.7	<0.05	0.3														7.7	
15	0.01	1.131	0.896	7.46	19.3	<0.05	0.4													14.0	6.9	
16	0.00	1.092	0.861	7.29	19.4	<0.05	0.2	0.2			8.6		64			15.1		122		5.4	6.8	
17	0.00	1.093	0.816	7.27	19.3	<0.05	0.1		456	8.0			54		617	15.1		103		2.0	5.6	
18	0.00	1.100	0.921	7.28	19.3	<0.05	0.4														6.9	
19	0.00	1.119	1.002	7.43	19.3	<0.05	0.1		226	8.4			70		209	14.6		122		4.5	7	
20	0.00	1.098	0.869	7.36	19.0	<0.05	<0.1		290	9.3			67		392	19.6		142			5.8	
21	0.00	1.089	0.898	7.44	19.3	<0.05	0.3														9.5	
22	0.00	1.053	0.872	7.40	19.2	<0.05	0.2														7.7	
23	0.00	1.076	0.848	7.35	19.3	<0.05	0.3	0.2			9.4		69			20.8		149		6.2	7.2	
24	0.00	1.102	0.855	7.30	19.1	<0.05	<0.1		213.0	9.7			69		261	16.5		118		13.0	5.4	
25	0.00	1.055	0.852	7.40	19.9	<0.05	0.2														8.3	
26	0.00	1.119	0.950	7.41	19.9	<0.05	0.5		164.0	7.9			63							33.0	9.3	
27	0.00	1.103	0.861	7.35	19.9	<0.05	0.1		267.0	10.6			76		302	25.1		180			6.6	
28	0.00	1.067	0.866	7.35	20.0	<0.05	<0.1														8.2	
29	0.00	1.059	0.853	7.42	20.2	<0.05	0.2														6.5	
30	0.00	1.068	0.841	7.41	20.1	<0.05	<0.1						x		x			x		x	6.9	x
TOTAL	0.02	33.72	27.17																			

Temp. Limit Exceeded **LOW VOLUME**

(MEDIAN)

AVG	0.00	1.12	0.91	7.37	19.39	<0.05	0.24	0.23	257.25	9.93	9.93	77.03	77.03	313.60	19.61	19.32	150.89	150.54	6.2	7.2	7.2
MIN	0.00	1.05	0.82	7.27	18.40	<0.05	0.10	0.20	164.00	7.80	8.57	54.44	64.01	209.00	14.60	15.10	102.76	122.27	2.0	4.9	6.8
MAX	0.01	1.22	1.02	7.46	21.50	<0.05	0.50	0.30	456.00	14.20	12.53	115.59	101.62	617.00	25.10	22.47	192.91	182.31	33.0	9.5	7.6

DISCHARGE LIMITS:																					
INSTANT MAX.						1.8	3													225	
DAILY MAX.						0.24															
7 DAY AVG.							1.5			45		700			45					100	
30 DAY AVG.							1			30		465			30					14	75
DAILY MAX. OF 10%								1												43	
pH				6.0/9.0																	
SIX MONTH MEDIAN						0.06															

TSS 85% REMOVAL

BOD 75% REMOVAL

TOTAL RAINFALL (year-to-date):

51.56

CALCULATED % REMOVALS

TSS **96.14**

BOD **93.75**

CITY OF WASHINGTON WPCF - SUMMARY OF TREATMENT REPORT

DISCHARGE MONITORING - PERMIT No. CA0022756

ORDER # R1-2017-0002 ID # 1A84006ODN

Jun-19

ALL SAMPLES ARE FROM MONITORING LOCATION EFF-001 WITH EXCEPTION OF THE
THREE IN BOLD MARKED INF

DAY	RAIN IN	FLOW MGD	INF TOTAL AMMONIA mg/L	ONE SAMPLE PER MONTH REQUIRED					GREASE & OIL mg/L
				TOTAL AMMONIA mg/L	TOTAL COPPER mg/L	TOTAL COPPER ug/L	TOTAL NICKEL mg/L	TOTAL NICKEL ug/L	
1	0.00	0.849							
2	0.00	1.023							
3	0.00	0.976	30.2	13.6					
4	0.00	0.952							
5	0.00	0.994				14.000		13	
6	0.00	0.951	28.7	17.4					ND
7	0.00	0.832							
8	0.00	0.918							
9	0.00	0.884							
10	0.00	0.968	26.6	12.6					
11	0.00	0.943							
12	0.00	0.957							
13	0.01	0.918	26.5	19.7					
14	0.00	0.947							
15	0.01	0.896							
16	0.00	0.861							
17	0.00	0.816	28.2	12.2					
18	0.00	0.921							
19	0.00	1.002	26.50	16.7					
20	0.00	0.869	27.0	15.4					
21	0.00	0.898							
22	0.00	0.872							
23	0.00	0.848							
24	0.00	0.855	29.8	14.1					
25	0.00	0.852							
26	0.00	0.950	29.7	17.1					
27	0.00	0.861							
28	0.00	0.866							
29	0.00	0.853							
30	0.00	0.841							
TOTAL	0.02	27.17							

AVG	0.00	0.91	28.1	15.4	#DIV/0!	14.0	#DIV/0!	13.0	#DIV/0!
MIN	0.00	0.82	26.5	12.2	0.0	14.0	0.0	13.0	0.0
MAX	0.01	1.02	30.2	19.7	0.0	14.0	0.0	13.0	0.0

ND = NON DETECTED

NA = NOT ANALYZED

ANALYTE	Units	METHOD USED	Daily Max	Avg. Monthly	Avg. Wkly	Inst. Max
TOTAL COPPER	ug/L	EPA 200.7	300			1500.000
TOTAL NICKEL	ug/L	EPA 200.7	600			
GREASE & OIL	mg/L	EPA 1664		25	40	75.0

CITY OF CRESCENT CITY WPCF - SUMMARY OF TREATMENT REPORT

CITY OF C

DISCHARGE MONITORING - PERMIT No. CA0022756

ORDER # R1-2017-0002 ID # 1A84006ODN

Jul-19

Jul-19

ALL SAMPLES ARE FROM MONITORING LOCATION EFF-001 WITH EXCEPTION OF THE THREE IN BOLD MARKED INF

DAY	DAILY REQUIREMENTS						WEEKLY REQUIREMENTS														DAY	RAIN IN						
	RAIN IN	INF FLOW MGD	FLOW MGD	pH	Temp	TOTAL CL ₂ mg/L	Settleable Solids		SUSPENDED SOLIDS					BOD 5					FECAL MPN	TURB NTU			TURB Wkly Avg					
							EFF	Wkly Avg(mg/L)	INF mg/L	EFF mg/L	Wkly Avg (mg/L)	LBS/DAY	Wkly Avg(lb/day)	INF mg/L	EFF mg/L	Wkly Avg(mg/L)	LBS/DAY	Wkly Avg(lb/day)										
30	0.00	1.068	0.841				<0.1																				31	0.00
1	0.00	1.084	0.905	7.41	20.7	<0.05	0.2	0.157	188	8.3	8.6	63	63	260	16.5	16.5	125	121	11.0	7.6	7.0					1	0.00	
2	0.00	1.072	1.023	7.40	20.70	<0.05	0.2														7.8					2	0.00	
3	0.00	1.082	0.884	7.22	20.10	<0.05	<0.1		196	9.6		71		273	17.4		128		11.0	6.5						3	0.00	
4	0.00	1.058	0.843	7.28	20.50	<0.05	0.1		212	8.0		56		227	15.6		110			6.3						4	0.00	
5	0.00	1.116	0.932	7.37	20.50	<0.05	0.3														7.1					5	0.00	
6	0.00	1.140	0.938	7.37	20.50	<0.05	0.1												4.5		7					6	0.00	
7	0.00	1.097	0.857	7.39	20.50	<0.05	0.1	0.143			8.4		63			19.4				6.6		7.1				7	0.00	
8	0.00	1.068	0.879	7.36	20.40	<0.05	0.2		239	9.7		71		296	19.4		142		1600.0	6.4						8	0.00	
9	0.00	1.132	0.916	7.50	21.00	<0.05	0.2													8.4						9	0.00	
10	0.00	1.133	0.910	7.42	21.20	<0.05	0.1												4.5	7.1						10	0.00	
11	0.00	1.123	0.932	7.41	21.10	<0.05	0.1		265	7.0		54		345	19.4		151			7.4						11	0.00	
12	0.00	1.100	0.878	7.44	21.40	<0.05	0.2													8.1						12	0.00	
13	0.00	1.029	0.844	7.32	21.10	<0.05	0.1												4.5	5.4						13	0.00	
14	0.00	1.045	0.818	7.29	21.40	<0.05	0.2	0.200			9.7		69			17.0		121		5.3		7.3				14	0.00	
15	0.01	1.038	0.808	7.26	21.10	<0.05	0.1		221.0	8.0		54		228.0	16.0		108		14.0	4.9						15	0.01	
16	0.00	1.049	0.926	7.29	21.70	<0.05	0.5													7.6						16	0.00	
17	0.00	1.054	0.880	7.20	21.40	<0.05	0.1		201	11.4		84		286	18.3		134		4.5	5.3						17	0.00	
18	0.00	1.041	0.872	7.34	21.90	<0.05	0.1		209	9.6		70		238	16.8		122			6.5						18	0.00	
19	0.00	1.035	0.778	7.41	21.70	<0.05	0.3													16						19	0.00	
20	0.00	1.027	0.686	7.33	21.10	<0.05	<0.1												2.0	5.2						20	0.00	
21	0.00	1.010	0.716	7.38	21.00	<0.05	<0.1	0.157			12.5		78			17.0		106		5.4		7.0				21	0.00	
22	0.00	1.036	0.751	7.40	21.20	<0.05	0.2		547	16.0		100		1090	17.2		108		12.0	10						22	0.00	
23	0.00	1.022	0.732	7.29	21.50	<0.05	0.4													5.4						23	0.00	
24	0.00	1.037	0.737	7.44	21.20	<0.05	0.1		271	11.9		73								6.8						24	0.00	
25	0.00	1.038	0.755	7.47	21.50	<0.05	0.1		232	9.7		61		286	16.7		105			8.6						25	0.00	
26	0.01	1.044	0.744	7.45	21.50	<0.05	0.1													8.3						26	0.01	
27	0.00	1.046	0.756	7.41	21.30	<0.05	<0.1													4.4						27	0.00	
28	0.00	0.999	0.698	7.33	21.30	<0.05	<0.1	0.229			8.7		51			16.3		100		4.3		6.5				28	0.00	
29	0.00	1.003	0.701	7.30	21.20	<0.05	<0.1		261	7.3		43		298	13.9		81		4.5	5						29	0.00	
30	0.00	1.030	0.750	7.51	21.50	<0.05	0.3													9.9						30	0.00	
31	0.00	1.052	0.725	7.50	21.70	<0.05	0.4		189	9.8		59		247	17.5		106			7.3						31	0.00	
1	0.00	1.047	0.772				0.1		267	9.0				317	17.4		112			7						1	0.00	
2	0.00	1.024	0.728				0.5													5.9						2	0.00	
3	0.00	1.025	0.730				<0.1													6.1						3	0.00	
TOTAL	0.02	33.89	25.57																							TOTAL	0.02	

Temp. Limit Exceeded low volume from Ranney Tower log estimated from SCADA

Monthly																					(MEDIAN)					
AVG	0.00	1.06	0.82	7.37	21.13	<0.05	0.17	0.18	248.54	9.72	9.58	66.07	64.85	339.50	17.06	17.23	118.31	118.98	4.50	7.03	7.0	AVG	0.00			
MIN	0.00	1.00	0.69	7.20	20.10	0.00	0.10	0.14	188.00	7.00	8.35	42.68	50.97	227.00	13.90	16.27	81.26	99.70	2.0	4.30	6.5	MIN	0.00			
MAX	0.01	1.14	1.02	7.51	21.90	0.00	0.50	0.23	547.00	16.00	12.53	100.21	78.15	1090.00	19.40	19.40	150.79	146.51	1600.0	16.00	7.3	MAX	0.01			
DISCHARGE LIMITS:																										
INSTANT MAX.							1.8	3															225	ND = NON DETECTED		
DAILY MAX.							0.24																			
7 DAY AVG.							1.5	45	700	45															100	
30 DAY AVG.							1	30	465	30															75	
DAILY MAX. OF 10%							1															43				
pH	6.0/9.0																									
SIX MONTH MEDIAN	0.06																									
												TSS 85% REMOVAL					BOD 75% REMOVAL									

TOTAL RAINFALL (year-to-date):	51.58	CALCULATED % REMOVALS	
		TSS 96.09	BOD 94.98

RESCENT CITY WPCF - SUMMARY OF TREATMENT REPORT

DISCHARGE MONITORING - PERMIT No. CA0022756

ORDER # R1-2017-0002 ID # 1A84006ODN

ALL SAMPLES ARE FROM MONITORING LOCATION EFF-001 WITH EXCEPTION OF THE THREE IN BOLD MARKED INF

FLOW MGD	INF TOTAL AMMONIA mg/L	ONE SAMPLE PER MONTH REQUIRED					GREASE & OIL mg/L
		TOTAL AMMONIA mg/L	TOTAL COPPER mg/L	TOTAL COPPER ug/L	TOTAL NICKEL mg/L	TOTAL NICKEL ug/L	
0.841							
0.905	26.5	13.5					
1.023							
0.884	29.3	18.3					
0.843							
0.932							
0.938							
0.857							
0.879	30.3	16					
0.916							
0.910							
0.932	28.8	15.7					
0.878							
0.844							
0.818							
0.808	31.2	15.7					
0.926							
0.880			0.014	14	0.011	11.000	ND<5.1
0.872	29.6	17.4					
0.778							
0.686							
0.716							
0.751	31.3	20.6					
0.732							
0.737							
0.755	33.3	15.9					
0.744							
0.756							
0.698							
0.701	35.5	16.3					
0.750							
0.725							
0.772							
0.728							
0.730							
25.57							

0.82	30.64	16.60	0.01	14.00	0.01	11.00	<5.1
0.69	26.50	13.50	0.01	14.00	0.01	11.00	0.00
1.02	35.50	20.60	0.01	14.00	0.01	11.00	0.00

NA = NOT ANALYZED

Units	METHOD USED	Daily Max	Avg. Monthly	Avg. Wkly	Inst. Max
ug/L	EPA 200.7	300			1500.000
ug/L	EPA 200.7	600			
mg/L	EPA 1664		25	40	75.0

CITY OF CRESCENT CITY WPCF - SUMMARY OF TREATMENT REPORT

C

DISCHARGE MONITORING - PERMIT No. CA0022756

ORDER # R1-2017-0002 ID # 1A84006ODN

Aug-19

Aug-19

ALL SAMPLES ARE FROM MONITORING LOCATION EFF-001 WITH EXCEPTION OF THE THREE IN BOLD MARKED INF

DAY	DAILY REQUIREMENTS							WEEKLY REQUIREMENTS													DAY		
	RAIN IN	INF FLOW MGD	FLOW MGD	pH	temp	TOTAL CL ₂ mg/L	Settleable Solids		SUSPENDED SOLIDS					BOD 5					FECAL MPN	TURB NTU		TURB Wkly Avg	
							EFF	Wkly Avg(mg/L)	INF mg/L	EFF mg/L	Wkly Avg (mg/L)	LBS/DAY	Wkly Avg(lb/day)	INF mg/L	EFF mg/L	Wkly Avg(mg/L)	LBS/DAY	Wkly Avg(lb/day)					
1	0	1.047	0.772	7.45	21.5	<0.05	0.1	x	267	9	x	58	x	317	17.4	x	112	x		7	x	1	
2	0	1.024	0.728	7.39	22.4	<0.05	0.5												6.8	6.1		2	
3	0	1.025	0.73	7.45	22.7	<0.05	<0.1													6.9		3	
4	0.00	1.008	0.724	7.40	22.70	<0.05	<0.1													6.9		4	
5	0.00	1.024	0.768	7.37	22.40	<0.05	0.3		273	10.6		68		312	21.5		138		7.8	9.5		5	
6	0.20	1.031	0.796	7.46	22.80	<0.05	0.2	0.240			12.1				26.0		168		8.5	8.9		6	
7	0.000	1.038	0.825	7.53	22.70	<0.05	0.2		283	12.3		85	78	296	23.6		162		11.0	8.6		7	
8	0.000	1.025	0.745	7.44	22.60	<0.05	0.5		198	13.3		83		250	32.9		204			11		8	
9	0.010	0.996	0.724	7.56	22.80	<0.05	0.2													11		9	
10	0.000	1.039	0.767	7.45	22.60	<0.05	0.2												17.0	6.6		10	
11	0.000	1.008	0.717	7.33	22.90	<0.05	0.1													6		11	
12	0.000	1.006	0.719	7.26	22.70	<0.05	0.1		203	9.0		54		212	16.0		96		13.0	4.9		12	
13	0.000	1.005	0.741	7.29	22.80	<0.05	0.1				9.5		56		16.0				6.8			13	
14	0.00	1.017	0.750	7.39	22.60	<0.05	0.1	0.130									96		17.0	7.3	6.2	14	
15	0.00	0.986	0.701	7.32	22.60	<0.05	0.1		263	9.9		58							5.3			15	
16	0.00	0.990	0.744	7.33	22.00	<0.05	0.3													7.6		16	
17	0.00	0.963	0.706	7.27	21.90	<0.05	0.1													5.3		17	
18	0.00	0.984	0.730	7.29	21.60	<0.05	0.1													5.8		18	
19	0.00	0.996	0.733	7.16	21.80	<0.05	<0.1		243	7.7		47		308	14.9		91		17.0	5		19	
20	0.00	0.990	0.698	7.20	21.60	<0.05	<0.1				8.1				13.9					3.9		20	
21	0.24	1.012	0.791	7.29	22.30	<0.05	0.1	0.110	233.0	8.6		57		282.0	12.3		81	86	<1.8	5.5	4.7	21	
22	0.00	0.956	0.708	7.23	22.50	<0.05	0.1		189	8.1		48	51	159	14.5		86			4.1		22	
23	0.00	0.987	0.736	7.36	22.00	<0.05	0.2													5		23	
24	0.00	0.970	0.678	7.34	21.70	<0.05	<0.1												4.5	3.8		24	
25	0.00	1.016	0.734	7.19	21.80	<0.05	<0.1													3.7		25	
26	0.00	1.011	0.721	7.16	21.90	<0.05	<0.1		295	9.8		59	53	317	14.6	13.6	88		2.0	5		26	
27	0.00	0.995	0.682	7.26	22.30	<0.05	<0.1	<0.1												84	4.2	4.7	27
28	0.50	1.005	0.761	7.30	22.30	<0.05	<0.1		202	7.7	8.6	49		223.0	12.4		79			5.6		28	
29	0.00	0.993	0.747	7.31	22.60	<0.05	<0.1		254	8.3		52		232	13.8		86			5.4		29	
30	0.00	0.982	0.660	7.24	22.70	<0.05	<0.1													4.3		30	
31	0.00	1.010	0.743	7.43	22.20	<0.05	<0.1													5		31	
TOTAL	0.95	31.14	22.78																			TOTAL	

compositor temperature exceeded 6 degrees celsius

(MEDIAN)

AVG	0.03	1.00	0.73	7.34		<0.05	0.16	0.15	241.92	9.53	9.56	59.67	59.51	264.36	17.63	17.38	111.16	108.57	9.4	6.1	6.1	AVG
MIN	0.00	0.96	0.66	7.16		0.00	0.10	0.11	189.00	7.70	8.13	47.07	50.54	159.00	12.30	13.60	78.70	84.16	<1.8	3.7	4.7	MIN
MAX	0.50	1.05	0.83	7.56		0.00	0.50	0.24	295.00	13.30	12.07	84.63	78.39	317.00	32.90	26.00	204.42	168.17	17	11.0	8.9	MAX

DISCHARGE LIMITS:																					
INSTANT MAX.						1.8	3													225	ND = NON DET
DAILY MAX.						0.24															
7 DAY AVG.							1.5			45		700		45						100	
30 DAY AVG.							1			30		465		30					14	75	ANALYTE
DAILY MAX. OF 10%								1											43		TOTAL COPPEP
pH				6.0/9.0																	TOTAL NICKEL
SIX MONTH MEDIAN						0.06															GREASE & OIL

TOTAL RAINFALL (year-to-date): 52.53

TSS 85% REMOVAL

BOD 75% REMOVAL

TSS 96.06

CALCULATED % REMOVALS

BOD 93.33

ITY OF CRESCENT CITY WPCF - SUMMARY OF TREATMENT REPORT

DISCHARGE MONITORING - PERMIT No. CA0022756

ORDER # R1-2017-0002 ID # 1A84006ODN

ALL SAMPLES ARE FROM MONITORING LOCATION EFF-001 WITH EXCEPTION OF THE THREE IN BOLD MARKED INF

RAIN IN	FLOW MGD	INF TOTAL AMMONIA mg/L	ONE SAMPLE PER MONTH REQUIRED					GREASE & OIL mg/L
			TOTAL AMMONIA mg/L	TOTAL COPPER mg/L	TOTAL COPPER ug/L	TOTAL NICKEL mg/L	TOTAL NICKEL ug/L	
0.00	0.772	27.8	14.7					
0.00	0.728							
0.00	0.730							
0.00	0.724							
0.00	0.768	34.9	17.0					
0.20	0.796							
0.00	0.825							
0.00	0.745	27.0	17.5					
0.01	0.724							
0.00	0.767							
0.00	0.717							
0.00	0.719	25.4	14					
0.00	0.741							
0.00	0.750			0.015	15	0.010	10.000	ND<5.3
0.00	0.701	28.6	16.2					
0.00	0.744							
0.00	0.706							
0.00	0.730							
0.00	0.733	33.4	15					
0.00	0.698							
0.24	0.791	27.2	8.06					
0.00	0.708	25.10	13.3					
0.00	0.736							
0.00	0.678							
0.00	0.734							
0.00	0.721	30.7	10.7					
0.00	0.682							
0.50	0.761	26.2	9.4					
0.00	0.747	25.6	13.9					
0.00	0.660							
0.00	0.743							
0.95	22.78							

0.03	0.73	28.35	13.61	0.02	15.00	0.01	10.00	ND<5.3
0.00	0.66	25.10	8.06	0.02	15.00	0.01	10.00	0.00
0.50	0.83	34.90	17.50	0.02	15.00	0.01	10.00	0.00

ECTED

NA = NOT ANALYZED

Units	METHOD USED	Daily Max	Avg. Monthly	Avg. Wkly	Inst. Max
ug/L	EPA 200.7	300			1500.000
ug/L	EPA 200.7	600			
mg/L	EPA 1664		25	40	75.0

CITY OF CRESCENT CITY WPCF - SUMMARY OF TREATMENT REPORT

C

DISCHARGE MONITORING - PERMIT No. CA0022756

ORDER # R1-2017-0002 ID # 1A84006ODN

Sep-19

Sep-19

ALL SAMPLES ARE FROM MONITORING LOCATION EFF-001 WITH EXCEPTION OF THE THREE IN BOLD MARKED INF

DAY	DAILY REQUIREMENTS							WEEKLY REQUIREMENTS											DAY						
	RAIN IN	INF FLOW MGD	FLOW MGD	pH	temp	TOTAL CL ₂ mg/L	Settleable Solids		SUSPENDED SOLIDS					BOD 5						FECAL MPN	TURB NTU	TURB Wkly Avg			
							EFF	Wkly Avg(mg/L)	INF mg/L	EFF mg/L	Wkly Avg (mg/L)	LBS/DAY	Wkly Avg(lb/day)	INF mg/L	EFF mg/L	Wkly Avg(mg/L)	LBS/DAY	Wkly Avg(lb/day)							
1	0.00	1.005	0.726	7.34	22.80	<0.05	<0.1				8.7		53.5			15.3		94.1			7.8	5.4	7.3	1	
2	0.00	1.009	0.779	7.38	22.30	<0.05	<0.1			270	9.4		61		259	14.6		95			7.8	6.7	7.3	2	
3	0.00	0.976	0.696	7.35	22.60	<0.05	0.1	0.130														10			3
4	0.00	0.985	0.745	7.37	22.40	<0.05	0.1			318	8.2		51		317	16.6		103		49.0	6.1				4
5	0.00	0.970	0.692	7.54	22.40	<0.05	<0.1			376	8.4		48		284	14.6		84			7.1				5
6	0.00	0.959	0.682	7.42	22.50	<0.05	0.3															10			6
7	0.04	0.967	0.726	7.43	22.50	<0.05	0.1													2.0	6.1				7
8	0.16	1.090	0.697	7.35	22.50	<0.05	<0.1				8.4		49.4			15.2		89.3			7.8	4.4			8
9	0.16	1.005	0.739	7.33	22.30	<0.05	<0.1			408	9.1		56		363	15.8		97			7.8	7.2	6.6		9
10	0.02	0.997	0.691	7.47	22.70	<0.05	0.1															8.4			10
11	0.00	1.002	0.715	7.45	22.40	<0.05	0.1	0.130		336	8.4		50		303	14.2		85		2.0	5.6				11
12	0.00	0.962	0.656	7.41	22.40	<0.05	<0.1			355	7.7		42		256	15.7		86			5.8				12
13	0.00	0.952	0.680	7.46	22.30	<0.05	0.3															12			13
14	0.00	0.965	0.720	7.42	22.20	<0.05	<0.1													11.0	2.6				14
15	0.78	0.993	0.782	7.39	21.90	<0.05	<0.1				8.2		54.3			11.2		74.6			2.0	2.5			15
16	0.15	1.021	0.778	7.29	21.80	<0.05	<0.1			351	8.1		53		311	7.8		51			2.0	6.6	5.4		16
17	1.35	1.149	0.884	7.61	20.60	<0.05	<0.1	0.130														6.8			17
18	0.70	1.088	0.810	7.38	21.10	<0.05	<0.1			295	8.3		56		289	14.6		99		<1.8	6.3				18
19	0.20	1.042	0.718	7.44	20.80	<0.05	<0.1															5.1			19
20	0.00	1.021	0.748	7.42	21.70	<0.05	<0.1															6.4			20
21	0.20	1.011	0.706	7.21	21.70	<0.05	0.3															3.9			21
22	0.50	1.018	0.739	7.27	21.40	<0.05	<0.1				6.7		41.0			10.6		65.0				4.7			22
23	0.10	1.021	0.755	7.28	21.60	<0.05	0.1	0.130		268	7.1		45		303	11.2		71		4.5	7.3	5.6			23
24	0.00	1.026	0.754	7.33	21.60	<0.05	0.3															6			24
25	0.00	1.029	0.723	7.34	21.50	<0.05	0.1			226	6.7		40		275	10.4		63			5.4				25
26	0.01	1.040	0.734	7.30	20.50	<0.05	<0.1			260	6.2		38		289	10.1		62			4.7				26
27	0.00	0.992	0.735	7.35	21.00	<0.05	0.1															7			27
28	0.03	0.972	0.650	7.26	19.90	<0.05	<0.1															4.4			28
29	0.39	1.014	0.718	7.24	19.90	<0.05	0.1					x		x		x		x				3.8		x	29
30	0.00	1.004	0.734	7.32	19.70	<0.05	<0.1			232	6.2		38		316	12.2		75		<1.8	6.3				30
TOTAL	4.79	30.29	21.91																						TOTAL
							Temp Limit Exceeded		instant max exceeded					avg monthly exceeded					(MEDIAN)						
AVG	0.16	1.01	0.73	7.37		<0.05	0.17	0.13	307.92	7.82	7.98	48.20	49.57	297.08	13.15	13.07	80.77	80.76		3	6.2	6.2		AVG	
MIN	0.00	0.95	0.65	7.21		0.00	<0.1	0.13	226.00	6.20	6.67	37.95	41.02	256.00	7.80	10.57	50.61	65.02		<1.8	2.5	5.4		MIN	
MAX	1.35	1.15	0.88	7.61		0.00	0.30	0.13	408.00	9.40	8.67	61.07	54.31	363.00	16.60	15.27	103.14	94.09		49	12.0	7.3		MAX	
DISCHARGE LIMITS:																									
INSTANT MAX.						1.8	3														225	ND = NON DET			
DAILY MAX.						0.24																			
7 DAY AVG.							1.5			45		700			45						100				
30 DAY AVG.							1			30		465			30						14	75	ANALYTE		
DAILY MAX. OF 10%								1													43	TOTAL COPPER			
pH				6.0/9.0																		TOTAL NICKEL			
SIX MONTH MEDIAN						0.06																GREASE & OIL			
						TSS 85% REMOVAL						BOD 75% REMOVAL													
TOTAL RAINFALL (year-to-date):						57.32						CALCULATED % REMOVALS													
						TSS 97.46						BOD 95.57													

ITY OF CRESCENT CITY WPCF - SUMMARY OF TREATMENT REPORT

DISCHARGE MONITORING - PERMIT No. CA0022756

ORDER # R1-2017-0002 ID # 1A84006ODN

ALL SAMPLES ARE FROM MONITORING LOCATION EFF-001 WITH EXCEPTION OF THE THREE IN BOLD MARKED INF

RAIN IN	FLOW MGD	INF TOTAL AMMONIA mg/L	ONE SAMPLE PER MONTH REQUIRED						GREASE & OIL mg/L
			TOTAL AMMONIA mg/L	TOTAL COPPER mg/L	TOTAL COPPER ug/L	TOTAL NICKEL mg/L	TOTAL NICKEL ug/L		
0.00	0.726								
0.00	0.779	30.8	15.0						
0.00	0.696								
0.00	0.745								
0.00	0.692	29.0	15.2	<0.0001	<0.1	<0.0006	<0.6	93.5	
0.00	0.682	30.6	10.7	1.08	1080	0.069	68.9	<5	39.9
0.04	0.726	27.1	11.2	0.006.02	6.02	<0.0006	<0.6	21.3	
0.16	0.697	30.9	13.5	0.088	88.4	0.078	78	26.1	
0.16	0.739	31.8	12.3	0.1	100	0.093	93.1	30	30.1
0.02	0.691	27.4	14.6	0.181	181	0.116	116	36.4	
0.00	0.715	28.1	11.5	0.00997	99.7	0.0858	85.8	27.8	
0.00	0.656	28.4	15.4						
0.00	0.680								
0.00	0.720								
0.78	0.782								
0.15	0.778	33.7	11.7						
1.35	0.884								
0.70	0.810								
0.20	0.718								
0.00	0.748								
0.20	0.706								
0.50	0.739								
0.10	0.755	33.8	11.2						
0.00	0.754								
0.00	0.723								
0.01	0.734	36.7	9.84						
0.00	0.735								
0.03	0.650								
0.39	0.718								
0.00	0.734	32.3	10.4						
4.79	21.91								

avg weekly FOG

0.16	0.73	30.82	12.50	0.29	222.00	0.09	63.30	34.30
0.00	0.65	27.10	9.84	0.01	6.02	0.07	68.90	<5
1.35	0.88	36.70	15.40	1.08	1080.00	0.12	116.00	93.50

ECTED NA = NOT ANALYZED

Units	METHOD USED	Daily Max	Avg. Monthly	Avg. Wkly	Inst. Max
ug/L	EPA 200.7	300			1500.000
ug/L	EPA 200.7	600			
mg/L	EPA 1664		25	40	75.0

CITY OF CRESCENT CITY WPCF - SUMMARY OF TREATMENT REPORT

DISCHARGE MONITORING - PERMIT No. CA0022756

ORDER # R1-2017-0002 ID # 1A84006ODN

Oct-19

ALL SAMPLES ARE FROM MONITORING LOCATION EFF-001 WITH EXCEPTION OF THE THREE IN BOLD MARKED INF

DAY	DAILY REQUIREMENTS							WEEKLY REQUIREMENTS															
	RAIN IN	INF FLOW MGD	FLOW MGD	pH	Temp	TOTAL CL ₂ mg/L	Settleable Solids		SUSPENDED SOLIDS					BOD 5					FECAL MPN	TURB NTU	TURB Wkly Avg		
							EFF	Wkly Avg(mg/L)	INF mg/L	EFF mg/L	Wkly Avg (mg/L)	LBS/DAY	Wkly Avg(lb/day)	INF mg/L	EFF mg/L	Wkly Avg(mg/L)	LBS/DAY	Wkly Avg(lb/day)					
																						EFF	Wkly Avg(mg/L)
29	0.39	1.014	0.718	7.24	19.9	<0.05	0.1															3.8	
30	0.00	1.004	0.734	7.32	19.70	<0.05	<0.1		232	6.2			38		316	12.2		75				6.3	
1	0.00	1.012	0.670	7.36	19.8	<0.05	0.1				6.9		38			12.6		72				6.6	5.7
2	0.00	0.994	0.668	7.31	19.70	<0.05	<0.1	0.114	258	6.9			38		314	11.8		66		4.5	7.0		
3	0.10	0.974	0.669	7.33	20.20	<0.05	<0.1		194	6.8			38		218	13.7		76			6.3		
4	0.00	0.980	0.674	7.39	20.50	<0.05	<0.1														6.3		
5	0.00	0.976	0.650	7.36	20.00	<0.05	0.2													<1.8	3.8		
6	0.00	0.986	0.702	7.29	20.70	<0.05	<0.1														4.4		
7	0.00	0.976	0.990	7.23	20.00	<0.05	<0.1		209	8.0	7.2	66	54	226	15.0	13.3	124	100	6.8	5.4	5.6		
8	0.00	0.946	0.906	7.31	20.30	<0.05	0.1	0.400													6.8		
9	0.00	0.961	0.866	7.36	19.20	<0.05	<0.1		273	7.1		51		249	12.4		90		<1.8	4.6			
10	0.00	0.979	0.843	7.37	19.90	<0.05	<0.1		191.0	6.5	19.90	46		245.0	12.5		88			4.4			
11	0.01	0.949	0.835	7.32	20.00	<0.05	0.2														3.8		
12	0.00	0.924	0.810	7.32	19.10	<0.05	2.1												7.8	10			
13	0.00	0.948	0.878	7.24	19.00	<0.05	0.5														9.6		
14	0.00	0.932	0.814	7.27	18.60	<0.05	0.1		213	6.6	5.9	45	47	220	29.4	24.6	200	195	7.8	8.4	7.1		
15	0.00	0.939	0.832	7.24	19.10	<0.05	1.5	0.557													6.5		
16	1.45	1.099	1.104	7.27	19.00	<0.05	<0.1		214	5.3		49		267	17.1		157		4.5	7.2			
17	0.24	1.066	0.997	7.35	18.80	<0.05	<0.1		196	5.7		47		254	27.3		227			5.6			
18	0.51	0.992	0.939	7.40	19.60	<0.05	0.2														6.7		
19	0.42	1.171	1.134	7.28	19.00	<0.05	1.4														6		
20	0.02	1.019	0.988	7.22	19.20	<0.05	0.8														4		
21	0.02	0.995	0.877	7.22	18.80	<0.05	<0.1		355	5.5	4.9	40	37	329	12.4	11.8	91	89	7.8	4	4.4		
22	0.00	1.009	0.896	7.31	19.60	<0.05	<0.1	0.200													4.5		
23	0.00	0.997	0.953	7.29	19.90	<0.05	<0.1		262	4.7		37		278	12.4		99		<1.8	4.3			
24	0.00	0.976	0.879	7.34	20.30	<0.05	<0.1		216	4.5		33		256	10.7		78			4.6			
25	0.00	0.961	0.889	7.32	20.60	<0.05	<0.1														6.7		
26	0.00	0.972	0.857	7.30	19.30	<0.05	<0.1														2.4		
27	0.00	0.960	0.895	7.25	18.40	<0.05	<0.1														3.4		
28	0.00	0.941	0.829	7.24	18.20	<0.05	<0.1	<0.1	233	6.0	5.7	41	39	247	9.0	10.6	62	71	<1.8	3.5	6.0		
29	0.00	0.923	0.868	7.29	18.40	<0.05	<0.1														5.1		
30	0.00	1.060	0.801	7.29	18.30	<0.05	<0.1		281	4.4		29		321	9.2		61			6			
31	0.00	1.012	0.802	7.34	18.60	<0.05	<0.1		131	6.8		45		89.4	13.5		90			2.5			
1				7.43	18.30	<0.05	<0.1														13		
2				7.35	18.20	<0.05	<0.1													4.5	8.8		
TOTAL	2.77	30.63	26.52																				

Temp. Limit Exceeded low volume polymer

Monthly																				(MEDIAN)		
AVG	0.09	0.99	0.86	7.30	19.42	<0.05	0.30	0.30	0.27	230.43	6.06	6.11	43.38	43.02	250.96	14.74	14.57	107.80	105.59	4.50	5.50	5.8
MIN	0.00	0.92	0.65	7.22	18.20	<0.05	<0.1	<0.1	131.00	4.40	4.90	29.39	36.86	89.40	9.00	10.57	61.46	71.33	<1.8	2.40	4.4	
MAX	1.45	1.17	1.13	7.40	20.70	<0.05	2.10	0.56	355.00	8.00	7.20	66.05	54.34	329.00	29.40	24.60	227.00	194.68	7.8	10.00	7.1	

DISCHARGE LIMITS:																					
INSTANT MAX.							1.8	3													225
DAILY MAX.							0.24														
7 DAY AVG.								1.5		45			700		45						100
30 DAY AVG.								1		30			465		30				14		75
DAILY MAX. OF 10%									1											43	
pH				6.0/9.0																	
SIX MONTH MEDIAN							0.06														

TOTAL RAINFALL (year-to-date): 60.09

TSS 85% REMOVAL	BOD 75% REMOVAL
TSS 97.37	BOD 94.13

CITY OF CRESCENT CITY WPCF - SUMMARY REPORT

DISCHARGE MONITORING - PERMIT No. CA0022756

ORDER # R1-2017-0002 ID # 1A84006ODN

Oct-19

ALL SAMPLES ARE FROM MONITORING LOCATION EFF-001 WITH EXCEPTION OF THE
THREE IN BOLD MARKED INF

DAY	RAIN IN	FLOW MGD	INF TOTAL AMMONIA mg/L	ONE SAMPLE PER MONTH REQUIRED					GREASE & OIL mg/L
				TOTAL AMMONIA mg/L	TOTAL COPPER mg/L	TOTAL COPPER ug/L	TOTAL NICKEL mg/L	TOTAL NICKEL ug/L	
30	0.39	0.718							
31	0.00	0.734	32.3	10.4					
1	0.00	0.670			0.0096	9.6	0.0089	8.9	nd<4.5
2	0.00	0.668							
3	0.10	0.669	26.4	8.43					
4	0.00	0.674							
5	0.00	0.650							
6	0.00	0.702							
7	0.00	0.990	27.2	13.9					
8	0.00	0.906							
9	0.00	0.866	28.8						
10	0.00	0.843	28.9	10					
11	0.01	0.835							
12	0.00	0.810							
13	0.00	0.878							
14	0.00	0.814	28.6	15.5					
15	0.00	0.832							
16	1.45	1.104							
17	0.24	0.997	22.7	15.2					
18	0.51	0.939							
19	0.42	1.134							
20	0.02	0.988							
21	0.02	0.877	29.9	15.4					
22	0.00	0.896							
23	0.00	0.953	26.3	12.5	0.0089	8.9	<0.005	nd<5.0	
24	0.00	0.879	27.9	9.55					
25	0.00	0.889							
26	0.00	0.857							
27	0.00	0.895							
28	0.00	0.829	31.4	10					
29	0.00	0.868							
30	0.00	0.801							
31	0.00	0.802	29.5	11.2					
1	0.00	0.000							
2	0.00	0.000							
TOTAL	2.77	26.52							

AVG	0.09	0.86	27.96	12.17	0.01	9.25	0.01	6.95	<4.5
MIN	0.00	0.65	22.70	8.43	0.01	8.90	<0.005	<5	<4.5
MAX	1.45	1.13	31.40	15.50	0.01	9.60	0.01	8.90	<4.5

ND = NON DETECTED

NA = NOT ANALYZED

ANALYTE	Units	METHOD USED	Daily Max	Avg. Monthly	Avg. Wkly	Inst. Max
TOTAL COPPER	ug/L	EPA 200.7	300			1500.000
TOTAL NICKEL	ug/L	EPA 200.7	600			
GREASE & OIL	mg/L	EPA 1664		25	40	75.0

CITY OF CRESCENT CITY WPCF - SUMMARY REPORT

DISCHARGE MONITORING - PERMIT No. CA0022756

ORDER # R1-2017-0002 ID # 1A84006ODN

Nov-19

ALL SAMPLES ARE FROM MONITORING LOCATION EFF-001 WITH EXCEPTION OF THE THREE IN BOLD MARKED INF

DAY	DAILY REQUIREMENTS						WEEKLY REQUIREMENTS															
	RAIN IN	INF FLOW MGD	FLOW MGD	pH	temp	TOTAL CL ₂ mg/L	Settleable Solids		SUSPENDED SOLIDS					BOD 5				FECAL MPN	TURB NTU	TURB Wkly Avg		
							EFF	Wkly Avg(mg/L)	INF mg/L	EFF mg/L	Wkly Avg (mg/L)	LBS/DAY	Wkly Avg(lb/day)	INF mg/L	EFF mg/L	Wkly Avg(mg/L)	LBS/DAY				Wkly Avg(lb/day)	
31	0	1.012	0.802			<0.05	<0.1	x	131	6.8	x	45	x	321	9.2	x	62	x			x	
1	0	0.91	0.862	7.43	18.3	<0.05	<0.1													13		
2	0	0.913	0.907	7.35	18.2	<0.05	<0.1												4.5	8.8		
3	0.00	0.925	0.870	7.24	18.20	<0.05	<0.1													5.2		
4	0.00	0.911	0.893	7.26	18.10	<0.05	<0.1		253	7.2		54		282	22.2		165		17.0	6.3		
5	0.00	0.918	0.866	7.27	18.50	<0.05	<0.1				5.1					15.4		114		4.3	4.7	
6	0.010	0.919	0.895	7.17	18.10	<0.05	<0.1	<0.1	264	3.7		28	38	301	11.4		85		2.0	3.8		
7	0.010	0.930	0.872	7.25	18.30	<0.05	<0.1		276	4.4		32		291	12.6		92			3.1		
8	0.000	0.905	0.931	7.33	18.60	<0.05	<0.1													7		
9	0.000	0.927	0.911	7.27	18.60	<0.05	<0.1												2.0	3.2		
10	0.000	0.905	0.895	7.25	18.40	<0.05	<0.1													3.3		
11	0.020	0.949	0.909	7.23	18.40	<0.05	<0.1		325	5.5		42		443	11.0		83		2.0	2.9		
12	0.000	0.922	0.934	7.45	18.60	<0.05	<0.1				4.8		37			12.2		95		6.2		
13	0.02	0.920	0.897	7.46	18.10	<0.05	<0.1	0.100	537	5.0				355	10.5		79		4.5	4.2	3.9	
14	0.17	0.925	0.970	7.39	18.70	<0.05	<0.1		502	3.9		32		248	15.1		122			3.2		
15	0.06	0.913	0.962	7.41	18.50	<0.05	0.1													4		
16	0.01	0.896	0.880	7.40	18.70	<0.05	<0.1													3.4		
17	0.01	0.911	0.895	7.39	18.20	<0.05	<0.1													3.6		
18	0.39	0.921	0.924	7.24	17.80	<0.05	<0.1		263	4.9		38		275	12.3		95		4.5	4.6		
19	0.01	0.956	1.007	7.34	17.90	<0.05	<0.1	0.140			4.6					12.7				6.8		
20	0.00	0.914	0.897	7.36	17.50	<0.05	<0.1		235.0	4.5		34		281.0	13.4		100		2.0	4.8	4.8	
21	0.00	0.910	0.878	7.32	17.90	<0.05	<0.1		246	4.4		32	35	285	12.3		90			4.4		
22	0.00	0.872	0.872	7.53	17.80	<0.05	0.4													6.1		
23	0.00	0.895	0.851	7.21	17.70	<0.05	<0.1												4.5	3.5		
24	0.02	0.911	0.929	7.31	17.30	<0.05	<0.1													4.4		
25	0.07	0.917	0.889	7.38	17.10	<0.05	<0.1		217	6.0		44	73	293	14.4	20.5	107		14.0	4.1		
26	1.10	0.912	0.931	7.27	16.40	<0.05	<0.1											172		5.2	4.4	
27	0.31	1.076	1.097	7.40	15.70	<0.05	<0.1	<0.1	345	13.5	8.7	124		347.0	28.9		264			7		
28	0.00	0.989	0.954	7.27	15.10	<0.05	<0.1		232	6.5		52		307	18.3		146			4.2		
29	0.22	0.936	0.936	7.25	15.60	<0.05	<0.1													2.9		
30	0.09	0.943	0.979	7.25	16.00	<0.05	<0.1													3.3		
TOTAL	2.52	27.75	27.49																			

compositor temperature exceeded 7 degrees celsius polymer

(MEDIAN)

AVG	0.08	0.93	0.92	7.32		<0.05	0.11	0.11	307.92	5.79	5.79	46.35	45.54	309.00	15.20	15.20	119.00	119.00	4.5	4.9	4.5
MIN	0.00	0.87	0.85	7.17		<0.05	<0.1	<0.1	217.00	3.70	4.60	27.62	34.55	248.00	10.50	12.20	78.55	94.70	2.0	2.9	3.9
MAX	1.10	1.08	1.10	7.53		<0.05	0.40	0.14	537.00	13.50	8.67	123.51	73.24	443.00	28.90	20.53	264.41	172.26	17	13.0	4.8

DISCHARGE LIMITS:																					
INSTANT MAX.						1.8	3													225	
DAILY MAX.						0.24															
7 DAY AVG.							1.5			45		700			45					100	
30 DAY AVG.							1			30		465			30				14	75	
DAILY MAX. OF 10%								1											43		
pH				6.0/9.0																	
SIX MONTH MEDIAN						0.06															

TSS 85% REMOVAL

BOD 85% REMOVAL

TOTAL RAINFALL (year-to-date):	62.61	CALCULATED % REMOVALS	
		TSS 98.12	BOD 95.08

CITY OF CRESCENT CITY WPCF - SUMMARY REPORT

DISCHARGE MONITORING - PERMIT No. CA0022756

ORDER # R1-2017-0002 ID # 1A84006ODN

Nov-19

ALL SAMPLES ARE FROM MONITORING LOCATION EFF-001 WITH EXCEPTION OF THE
THREE IN BOLD MARKED INF

DAY	RAIN IN	FLOW MGD	INF TOTAL AMMONIA mg/L	ONE SAMPLE PER MONTH REQUIRED					GREASE & OIL mg/L
				TOTAL AMMONIA mg/L	TOTAL COPPER mg/L	TOTAL COPPER ug/L	TOTAL NICKEL mg/L	TOTAL NICKEL ug/L	
31	0.00	0.802							
1	0.00	0.862							
2	0.00	0.907							
3	0.00	0.870							
4	0.00	0.893	30.9	12.5					
5	0.00	0.866							
6	0.01	0.895			0.010	9.7	0.008	8.3	nd<4.8
7	0.01	0.872	32.3	13.5					
8	0.00	0.931							
9	0.00	0.911							
10	0.00	0.895							
11	0.02	0.909	33.9	13.3					
12	0.00	0.934							
13	0.02	0.897							
14	0.17	0.970	36.0	9.6					
15	0.06	0.962			0.0064	6.4			nd<4.8
16	0.01	0.880							
17	0.01	0.895							
18	0.39	0.924	31.0	9.3					
19	0.01	1.007							
20	0.00	0.897							
21	0.00	0.878	32.0	9.6					
22	0.00	0.872							
23	0.00	0.851							
24	0.02	0.929							
25	0.07	0.889	30.0	16					
26	1.10	0.931							
27	0.31	1.097							
28	0.00	0.954	27	11.0					
29	0.22	0.936							
30	0.09	0.979							
TOTAL	2.52	28.30							

AVG	0.08	0.92	31.64	11.85	0.01	8.05	0.01	8.30	nd<4.8
MIN	0.00	0.85	27.00	9.30	0.01	6.40	0.01	8.30	0.00
MAX	1.10	1.10	36.00	16.00	0.01	9.70	0.01	8.30	0.00

ND = NON DETECTED

NA = NOT ANALYZED

ANALYTE	Units	METHOD USED	Daily Max	Avg. Monthly	Avg. Wkly	Inst. Max
TOTAL COPPER	ug/L	EPA 200.7	300			1500.000
TOTAL NICKEL	ug/L	EPA 200.7	600			
GREASE & OIL	mg/L	EPA 1664		25	40	75.0

CITY OF CRESCENT CITY WPCF - SUMMARY REPORT

DISCHARGE MONITORING - PERMIT No. CA0022756

ORDER # R1-2017-0002 ID # 1A84006ODN

Dec-19

ALL SAMPLES ARE FROM MONITORING LOCATION EFF-001 WITH EXCEPTION OF THE THREE IN BOLD MARKED INF

DAY	DAILY REQUIREMENTS							WEEKLY REQUIREMENTS																
	RAIN IN	INF FLOW MGD	FLOW MGD	pH	temp	TOTAL CL ₂ mg/L	Settleable Solids		SUSPENDED SOLIDS				BOD 5			FECAL MPN	TURB NTU	TURB Wkly Avg						
							EFF	Wkly Avg(mg/L)	INF mg/L	EFF mg/L	Wkly Avg (mg/L)	LBS/DAY	Wkly Avg(lb/day)	INF mg/L	EFF mg/L				Wkly Avg(mg/L)	LBS/DAY	Wkly Avg(lb/day)			
1	0.02	0.977	0.901	7.26	16.60	<0.05	0.1					5.5		37.5			13.2		89.3		3.7			
2	0.00	0.949	0.829	7.23	16.90	<0.05	<0.1			238	5.6		39			311	14.9		103		17.0	3.9	4.5	
3	0.00	0.942	0.821	7.36	17.70	<0.05	<0.1															4.6		
4	0.00	0.950	0.811	7.39	17.10	<0.05	<0.1	0.100		275	5.6		38			365	13.2		89		23.0	4.2		
5	0.00	0.931	0.796	7.30	17.70	<0.05	<0.1			241	5.4		36			319	11.4		76			4.3		
6	0.72	0.928	0.833	7.25	17.70	<0.05	<0.1															5.4		
7	2.46	1.454	1.444	7.29	17.20	<0.05	<0.1														22.0	5.1		
8	0.02	1.321	1.295	7.14	16.30	<0.05	<0.1					6.3		60.7			13.7		140.8		6.2			
9	0.00	1.111	1.008	7.31	15.80	<0.05	<0.1			154	6.3		53								33.0	4.7	6.5	
10	0.37	1.117	1.034	7.23	16.00	<0.05	<0.1															4.1		
11	0.88	1.230	1.160	7.32	16.50	<0.05	<0.1	0.100		200	6.0		58			235	13.3		129		11.0	5		
12	1.61	1.383	1.310	7.28	17.00	<0.05	<0.1			195	6.5		71			232	14.0		153			6		
13	0.41	1.900	1.856	7.31	16.70	<0.05	0.1															14		
14	0.89	1.721	1.690	7.32	15.80	<0.05	<0.1														7.8	5.3		
15	0.02	1.636	1.546	7.16	15.00	<0.05	0.1					7.5		78.9			20.9		222.6		5.7			
16	0.00	1.458	1.292	7.21	14.60	<0.05	<0.1			131	7.1		77			168	15.8		170		2.0	4.9	5.9	
17	0.00	1.401	1.253	7.26	15.60	<0.05	<0.1															6.8		
18	0.30	1.364	1.183	7.27	16.20	<0.05	<0.1	0.130		209	7.4		73			286	16.1		159		7.8	5.5		
19	0.55	1.477	1.323	7.33	16.30	<0.05	<0.1			183	7.9		87			260	33.7		339			6		
20	0.03	1.524	1.367	7.46	16.60	<0.05	0.3															6.2		
21	2.61	2.256	1.870	7.41	16.60	<0.05	0.1															6.4		
22	0.71	2.799	2.666	7.15	15.20	<0.05	0.3					6.4		89.9			13.9		194.5		6.8			
23	0.02	2.255	2.088	7.25	14.80	<0.05	<0.1			102	8.0		139			109	16.6		289		1.8	5	5.8	
24	0.04	1.894	1.744	7.38	14.40	<0.05	<0.1	0.130														5.5		
25	0.00	1.668	1.440	7.26	14.50	<0.05	<0.1			140	6.1		73			175	13.6		163			5.7		
26	0.00	1.579	1.368	7.29	15.00	<0.05	<0.1			142	5.0		57			180	11.5		131			4.9		
27	0.00	1.498	1.347	7.34	15.50	<0.05	<0.1														4.5	6.5		
28	0.05	1.440	1.243	7.43	15.60	<0.05	<0.1															6.4		
29	0.81	1.310	1.567	7.34	15.60	<0.05	0.1					x		x			x		x			6.4	x	
30	0.03	1.400	1.446	7.29	15.20	<0.05	<0.1			178	7.6		92			170	16.5		199		4.5	5.6		
31	1.00	1.498	1.300	7.27	14.80	<0.05	<0.1															5.2		
TOTAL	13.55	45.37	41.83																					
pulled from ranney water data																								
estimate rerun to get value outside of regulatory holding time																								
(MEDIAN)																								
AVG	0.44	1.46	1.35	7.29		<0.05	0.11	0.12	183.69	6.50	6.41	68.65	66.73	234.17	15.63	15.40	166.67	161.82	7.8	5.7	5.7			
MIN	0.00	0.93	0.80	7.14		<0.05	<0.1	0.10	102.00	5.00	5.53	35.85	37.48	109.00	11.40	13.17	75.68	89.33	1.8	3.7	4.5			
MAX	2.61	2.80	2.67	7.46		<0.05	0.30	0.13	275.00	8.00	7.47	139.31	89.87	365.00	30.70	20.87	338.74	222.61	33	14.0	6.5			
DISCHARGE LIMITS:																								
INSTANT MAX.						1.8	3															225		
DAILY MAX.						0.24																		
7 DAY AVG.							1.5			45		700			45							100		
30 DAY AVG.							1			30		465			30						14	75		
DAILY MAX. OF 10%								1													43			
pH				6.0/9.0																				
SIX MONTH MEDIAN						0.06																		
										TSS 85% REMOVAL					BOD 75% REMOVAL									

TOTAL RAINFALL (year-to-date):	76.16	CALCULATED % REMOVALS	
		TSS 96.46	BOD 93.32

CITY OF CRESCENT CITY WPCF - SUMMARY OF TREATMENT REPORT

DISCHARGE MONITORING - PERMIT No. CA0022756

ORDER # R1-2017-0002 ID # 1A84006ODN

Dec-19

ALL SAMPLES ARE FROM MONITORING LOCATION EFF-001 WITH EXCEPTION OF THE
THREE IN BOLD MARKED INF

DAY	RAIN IN	FLOW MGD	INF TOTAL AMMONIA mg/L	ONE SAMPLE PER MONTH REQUIRED					GREASE & OIL mg/L
				TOTAL AMMONIA mg/L	TOTAL COPPER mg/L	TOTAL COPPER ug/L	TOTAL NICKEL mg/L	TOTAL NICKEL ug/L	
1	0.02	0.901							
2	0.00	0.829	32.0	13.0					
3	0.00	0.821							
4	0.00	0.811							
5	0.00	0.796	nd<0.1	9.5					
6	0.72	0.833							
7	2.46	1.444							
8	0.02	1.295							
9	0.00	1.008	21.0	12					
10	0.37	1.034							
11	0.88	1.160			<0.010	nd<10	0.0068	6.8	nd<4.8
12	1.61	1.310	22.0	8.5					
13	0.41	1.856							
14	0.89	1.690							
15	0.02	1.546							
16	0.00	1.292	16.0	9.4					
17	0.00	1.253							
18	0.30	1.183	21.0	16					
19	0.55	1.323							
20	0.03	1.367							
21	2.61	1.870							
22	0.71	2.666							
23	0.02	2.088	12.0	9.3					
24	0.04	1.744							
25	0.00	1.440							
26	0.00	1.368	16	9.2					
27	0.00	1.347							
28	0.05	1.243							
29	0.81	1.567							
30	0.03	1.446	15.0	13					
31	1.00	1.300							
TOTAL	13.55	41.83							

ccwql got 29.7, but not currently certified

AVG	0.44	1.35	19.38	11.10	<0.01	<10	0.01	6.80	<4.8
MIN	0.00	0.80	12.00	8.50	<0.01	<10	0.01	6.80	<4.8
MAX	2.61	2.67	32.00	16.00	<0.01	<10	0.01	6.80	<4.8

ND = NON DETECTED

NA = NOT ANALYZED

ANALYTE	Units	METHOD USED	Daily Max	Avg. Monthly	Avg. Wkly	Inst. Max
TOTAL COPPER	ug/L	EPA 200.7	300			1500.000
TOTAL NICKEL	ug/L	EPA 200.7	600			
GREASE & OIL	mg/L	EPA 1664		25	40	75.0

CITY OF CRESCENT CITY WPCF - SUMMARY OF TREATMENT REPORT
DISCHARGE MONITORING - PERMIT No. CA0022756
ORDER # R1-2017-0002 ID # 1A84006ODN

Jan-20 ALL SAMPLES ARE FROM MONITORING LOCATION EFF-001 WITH
EXCEPTION OF THE THREE IN BOLD MARKED INF

DAY	RAIN IN	FLOW MGD	INF TOTAL AMMONIA mg/L	ONE SAMPLE PER MONTH REQUIRED					
				TOTAL AMMONIA mg/L	TOTAL COPPER mg/L	TOTAL COPPER ug/L	TOTAL NICKEL mg/L	TOTAL NICKEL ug/L	GREASE & OIL mg/L
29	0.81	1.567							
30	0.03	1.446	15.00	13.00					
31	0.73	1.3							
1	0.02	1.518							
2	0.00	1.528	16.00	8.80					
3	0.54	1.429							
4	0.27	1.500							
5	0.05	1.489							
6	0.00	1.395	16.00	8.50					
7	0.67	1.545							
8	1.05	1.645	17.00	14.00	0.008	7.5	0.008	7.7	nd<5.5
9	0.02	2.002							
10	1.20	1.948							
11	0.32	2.156							
12	0.50	2.250							
13	2.00	2.727							
14	0.17	2.891							
15	2.02	2.780	9.99	7.84					
16	0.35	3.695	9.79	7.26					
17	0.05	2.854							
18	0.06	2.540							
19	0.00	2.263							
20	0.58	2.036	13.10	9.59					
21	0.15	2.243							
22	0.02	1.942							
23	0.66	1.906	13.60	10.40					
24	0.78	2.108							
25	1.68	2.872							
26	0.28	3.384							
27	0.87	2.900	8.78	8.50					
28	0.08	3.246							
29	0.54	2.798							
30	0.02	2.751	9.81	6.96					
31	0.07	2.326							
1	0.30	2.313							
TOTAL	15.02	70.67							

AVG	0.48	2.28	12.67	9.09	0.008	7.5	0.008	7.7	<5.5
MIN	0.00	1.40	8.78	6.96	0.008	7.5	0.008	7.7	<5.5
MAX	2.02	3.70	17.00	14.00	0.008	7.5	0.008	7.7	<5.5

ND = NON DETECTED

NA = NOT ANALYZED

ANALYTE	Units	METHOD USED	Daily Max	Avg. Monthly	Avg. Wkly	Inst. Max
TOTAL COPPER	ug/L	EPA 200.7	300			1500.000
TOTAL NICKEL	ug/L	EPA 200.7	600			
GREASE & OIL	mg/L	EPA 1664		25	40	75.0

CITY OF CRESCENT CITY WPCF - SUMMARY OF TREATMENT REPORT

DISCHARGE MONITORING - PERMIT No. CA0022756

ORDER # R1-2017-0002 ID # 1A84006ODN

Feb-20

ALL SAMPLES ARE FROM MONITORING LOCATION EFF-001 WITH EXCEPTION OF THE THREE IN BOLD MARKED INF

DAY	DAILY REQUIREMENTS						WEEKLY REQUIREMENTS																
	RAIN IN	INF FLOW MGD	FLOW MGD	pH	Temp.	TOTAL CL ₂ mg/L	Settleable Solids		SUSPENDED SOLIDS					BOD 5				FECAL MPN	TURB NTU	TURB Wkly Avg			
							EFF	Wkly Avg(mg/L)	INF mg/L	EFF mg/L	Wkly Avg (mg/L)	LBS/DAY	Wkly Avg(lb/day)	INF mg/L	EFF mg/L	Wkly Avg(mg/L)	LBS/DAY				Wkly Avg(lb/day)		
1	0.30	2.535	2.313	7.35	15.8	<0.05	0.1	x				x				x			17.0	6.5	x		
2	0.28	2.501	2.239	7.13	14.3	<0.05	<0.1					114					286			6.8			
3	0.01	2.355	2.092	7.33	13.6	<0.05	<0.1		115	7.1		124		122	17.6		307		14.0	5.6			
4	0.000	2.188	1.985	7.15	13.9	<0.05	<0.1				7.2					18.1			7.9	7.4			
5	0.000	2.099	1.857	7.27	14.9	<0.05	<0.1	0.100										4.0	6.2				
6	0.000	2.001	1.723	7.34	15.8	<0.05	<0.1		134	7.3		105		141	18.5		266			8.1			
7	0.130	1.924	1.769	7.43	15.7	<0.05	0.1													8.8			
8	0.020	1.903	1.673	7.43	15.4	<0.05	<0.1											4.5	8.6				
9	0.000	1.814	1.620	7.44	14.3	<0.05	<0.1						100					257		9.5			
10	0.000	1.742	1.523	7.37	15.1	<0.05	<0.1		150	9.7		123		178	23.4		297		11.0	9.1			
11	0.00	1.711	1.541	7.34	15.6	<0.05	<0.1	0.114							21.1				8.2	9.0			
12	0.00	1.686	1.466	7.36	15.2	<0.05	<0.1		175	8.5	8.1	104		189	19.6		240		17.0	9.1			
13	0.01	1.616	1.396	7.40	15.8	<0.05	<0.1		168	6.2		72		190	20.2		235			8.4			
14	0.00	1.599	1.373	7.41	15.5	<0.05	<0.1													8.9			
15	0.89	1.569	1.418	7.47	15.5	<0.05	0.2											49.0	9.8				
16	0.13	1.869	1.679	7.30	15.5	<0.05	0.1						85					258		8.6			
17	0.00	1.756	1.617	7.38	15.2	<0.05	0.1		144	7.9		107		167	22.3		301		4.0	8.7			
18	0.00	1.666	1.473	7.25	15.4	<0.05	<0.1	0.170			7.0				20.8				9.6	9.3			
19	0.00	1.601	1.369	7.45	15.1	<0.05	<0.1		187	7.0		80						2.0	8.4				
20	0.00	1.561	1.347	7.44	15.6	<0.05	0.3		175	6.1		69		207	19.2		216			8.8			
21	0.00	1.513	1.249	7.39	15.5	<0.05	0.4													9			
22	0.00	1.517	1.440	7.26	15.3	<0.05	0.1													12			
23	0.02	1.476	1.290	7.29	16.0	<0.05	0.1						86					228		10			
24	0.00	1.410	1.203	7.33	15.1	<0.05	0.1		177.0	6.8		68		213	21.7		218		4.5	10	10.2		
25	0.01	1.413	1.248	7.27	15.8	<0.05	0.1	0.114			8.7				22.9				10				
26	0.01	1.385	1.164	7.37	15.7	<0.05	0.1		174.0	11.6		113		220	23.7		230			11			
27	0.02	1.387	1.215	7.39	16.2	<0.05	<0.1		192.0	7.6		77		223	23.2		235			9.6			
28	0.02	1.329	1.140	7.14	15.8	<0.05	0.2													11			
29	0.01	1.348	1.138	7.42	15.4	<0.05	<0.1													9.5			
TOTAL	1.86	50.47	44.56																				
Temp. Limit Exceeded																							
																			(MEDIAN)				
AVG	0.06	1.74	1.54	7.34	15.31	<0.05	0.12	0.12	162.82	7.80	7.75	94.63	96.28	185.00	20.94	20.68	254.43	257.41	7.8	8.9	9.0		
MIN	0.00	1.33	1.14	7.13	13.60	<0.05	<0.1	0.10	115.00	6.10	7.00	68.22	85.00	122.00	17.60	18.05	215.69	227.63	2.00	5.6	7.4		
MAX	0.89	2.54	2.31	7.47	16.20	<0.05	0.40	0.17	192.00	11.60	8.67	123.88	114.39	223.00	23.70	22.87	307.07	286.46	49.00	12.00	10.2		
DISCHARGE LIMITS:																							
INSTANT MAX.						1.8	3													225			
DAILY MAX.						0.24																	
7 DAY AVG.							1.5			45		700			45					100			
30 DAY AVG.							1			30		465			30				14	75			
DAILY MAX. OF 10%								1											43				
pH				6.0/9.0																			
SIX MONTH MEDIAN						0.06																	
												TSS 85% REMOVAL					BOD 75% REMOVAL						
TOTAL RAINFALL (year-to-date):									16.88			CALCULATED % REMOVALS											
									TSS 95.21			BOD 88.68											

CITY OF CRESCENT CITY WPCF - SUMMARY OF TREATMENT REPORT

DISCHARGE MONITORING - PERMIT No. CA0022756

ORDER # R1-2017-0002 ID # 1A84006ODN

Feb-20

ALL SAMPLES ARE FROM MONITORING LOCATION EFF-001 WITH EXCEPTION OF THE
THREE IN BOLD MARKED INF

DAY	RAIN IN	FLOW MGD	INF TOTAL AMMONIA mg/L	ONE SAMPLE PER MONTH REQUIRED					GREASE & OIL mg/L
				TOTAL AMMONIA mg/L	TOTAL COPPER mg/L	TOTAL COPPER ug/L	TOTAL NICKEL mg/L	TOTAL NICKEL ug/L	
1	0.30	2.313							
2	0.28	2.239							
3	0.01	2.092	11.3	8.12					
4	0.00	1.985							
5	0.00	1.857			0.007	6.500	0.012	12	nd<4.9
6	0.00	1.723	14.0	8.5					
7	0.13	1.769							
8	0.02	1.673							
9	0.00	1.620							
10	0.00	1.523	17.1	12.6					
11	0.00	1.541							
12	0.00	1.466							
13	0.01	1.396	18.4	10.1					
14	0.00	1.373							
15	0.89	1.418							
16	0.13	1.679							
17	0.00	1.617	16.2	10.4					
18	0.00	1.473							
19	0.00	1.369							
20	0.00	1.347	20.2	9.88					
21	0.00	1.249							
22	0.00	1.440							
23	0.02	1.290							
24	0.00	1.203	22.2	12.1					
25	0.01	1.248							
26	0.01	1.164							
27	0.02	1.215	22.1	13.4					
28	0.02	1.140							
29	0.01	1.138							
TOTAL	1.86	44.56							

AVG	0.06	1.54	17.7	10.6	0.007	6.5	0.012	12.0	<4.9
MIN	0.00	1.14	11.3	8.1	0.007	6.5	0.012	12.0	<4.9
MAX	0.89	2.31	22.2	13.4	0.007	6.5	0.012	12.0	<4.9

ND = NON DETECTED

NA = NOT ANALYZED

ANALYTE	Units	METHOD USED	Daily Max	Avg. Monthly	Avg. Wkly	Inst. Max
TOTAL COPPER	ug/L	EPA 200.7	300			1500.000
TOTAL NICKEL	ug/L	EPA 200.7	600			
GREASE & OIL	mg/L	EPA 1664		25	40	75.0

CITY OF CRESCENT CITY WPCF - SUMMARY OF TREATMENT REPORT

DISCHARGE MONITORING - PERMIT No. CA0022756

ORDER # R1-2017-0002 ID # 1A84006ODN

C

Mar-20

Mar-20

ALL SAMPLES ARE FROM MONITORING LOCATION EFF-001 WITH EXCEPTION OF THE THREE IN BOLD MARKED INF

DAY	DAILY REQUIREMENTS							WEEKLY REQUIREMENTS													DAY									
	RAIN IN	INF FLOW MGD	FLOW MGD	pH	Temp.	TOTAL CL ₂ mg/L	Settleable Solids		SUSPENDED SOLIDS					BOD 5					FECAL MPN	TURB NTU		TURB Wkly Avg								
							EFF	Wkly Avg(mg/L)	INF mg/L	EFF mg/L	Wkly Avg (mg/L)	LBS/DAY	Wkly Avg(lb/day)	INF mg/L	EFF mg/L	Wkly Avg(mg/L)	LBS/DAY	Wkly Avg(lb/day)												
1	0.00	1.361	1.212	7.34	14.90	<0.05	<0.1				7.8		69.7				20.4	184.0		11		9.3	1							
2	0.00	1.310	1.151	7.42	14.90	<0.05	0.1		202	6.8		65			236	20.8		200		14.0	9.8		2							
3	0.00	1.302	1.119	7.34	15.60	<0.05	0.1														9.2		3							
4	0.02	1.294	1.133	7.40	15.50	<0.05	0.1	0.128	219	7.0		66		218	18.5		175		170.0	8.6			4							
5	0.01	1.279	0.972	7.42	16.50	<0.05	<0.1		215	9.6		78		228	21.9		178			7.5			5							
6	0.27	1.315	1.157	7.38	16.50	<0.05	0.3														9.1		6							
7	0.10	1.371	1.131	7.22	15.50	<0.05	0.1												79.0	10			7							
8	0.00	1.307	1.228	7.40	15.50	<0.05	0.8				10.8		91.4			21.1	178.8			12			8							
9	0.00	1.233	1.007	7.27	16.00	<0.05	0.2		220	15.0		126		248	26.4		222		4.0	8.7	8.2		9							
10	0.01	1.244	1.036	7.15	15.40	<0.05	1.0												7.8	10			10							
11	0.00	1.231	0.980	7.33	15.80	<0.05	<0.1	0.357	214	10.5		86		255	20.9		171		14.0	5.7			11							
12	0.00	1.207	1.071	7.34	16.10	<0.05	0.1		221	7.0		63		262	16.1		144		13.0	5.5			12							
13	0.41	1.211	1.042	7.43	15.90	<0.05	0.2												4.5	8.8			13							
14	0.47	1.294	1.126	7.48	15.50	<0.05	<0.1												4.5	6.4			14							
15	0.04	1.318	1.114	7.44	15.40	<0.05	0.1				8.8		71.1			17.6	142.9		4.5	6.9			15							
16	0.00	1.250	1.005	7.42	14.40	<0.05	<0.1		202	8.4		70		219	17.8		149		2.0	6.4	5.9		16							
17	0.00	1.239	1.029	7.41	15.60	<0.05	0.2												4.5	5.3			17							
18	0.00	1.208	0.943	7.45	16.30	<0.05	0.1	0.128	329	11.1		87		251	19.5		153		23.0	4.8			18							
19	0.00	1.207	0.982	7.36	16.10	<0.05	0.1		227	6.8		56		296	15.4		126		2.0	5.3			19							
20	0.00	1.172	0.904	7.42	16.40	<0.05	0.1												6.8	6.9			20							
21	0.00	1.173	0.904	7.39	16.90	<0.05	0.2												23.0	5.6			21							
22	0.00	1.155	0.934	7.42	16.70	<0.05	0.1				7.8		64.0			17.1	140.6		11.0	6.9			22							
23	0.27	1.161	0.934	7.32	16.60	<0.05	<0.1		226	8.9		69		279	18.4		143		13.0	5.3	5.6		23							
24	0.55	1.268	1.120	7.24	15.90	<0.05	<0.1												14.0	6.3			24							
25	0.13	1.258	1.048	7.23	15.90	<0.05	<0.1	0.143	221	8.2		72		255	18.7		163			5.4			25							
26	0.00	1.234	0.971	7.30	15.90	<0.05	<0.1		200	6.3		51		225	14.2		115			4.3			26							
27	0.10	1.178	1.000	7.24	15.80	<0.05	0.3													5.8			27							
28	0.12	1.178	0.968	7.38	16.20	<0.05	0.2													5.4			28							
29	0.58	1.153	0.939	7.34	16.50	<0.05	0.1				x		x			x	x			5.3	x		29							
30	0.52	1.397	1.241	7.38	15.80	<0.05	<0.1												13.0	5.8			30							
31	0.12	1.389	1.158	7.30	16.00	<0.05	0.1													5.9			31							
TOTAL	3.72	38.90	32.56																				TOTAL							
Temp. Limit Exceeded							(MEDIAN)																							
AVG	0.12	1.25	1.05	7.35	15.87	<0.05	0.18	0.19	224.67	8.80	8.80	74.08	74.08	247.67	19.05	19.05	161.57	161.57	12.0	7.1	7.2	AVG								
MIN	0.00	1.15	0.90	7.15	14.40	<0.05	<0.1	0.13	200.00	6.30	7.80	51.02	64.01	218.00	14.20	17.10	114.99	140.59	2.00	4.3	5.6	MIN								
MAX	0.58	1.40	1.24	7.48	16.90	<0.05	1.00	0.36	329.00	15.00	10.83	125.98	91.44	296.00	26.40	21.13	221.72	184.00	170.00	12.00	9.3	MAX								
DISCHARGE LIMITS:																														
INSTANT MAX.						1.8	3													225			ND = NON DET.							
DAILY MAX.						0.24																								
7 DAY AVG.							1.5			45		700			45					100										
30 DAY AVG.							1			30		465			30					75			ANALYTE							
DAILY MAX. OF 10%								1												43			TOTAL COPPER							
pH				6.0/9.0																			TOTAL NICKEL							
SIX MONTH MEDIAN						0.06																	GREASE & OIL							
TOTAL RAINFALL (year-to-date):							20.60		TSS 85% REMOVAL					BOD 75% REMOVAL																
									TSS 96.08					BOD 92.31																

CITY OF CRESCENT CITY WPCF - SUMMARY OF TREATMENT REPORT

DISCHARGE MONITORING - PERMIT No. CA0022756

ORDER # R1-2017-0002 ID # 1A84006ODN

ALL SAMPLES ARE FROM MONITORING LOCATION EFF-001 WITH EXCEPTION OF THE THREE IN BOLD MARKED INF

RAIN IN	FLOW MGD	INF TOTAL AMMONIA mg/L	ONE SAMPLE PER MONTH REQUIRED					GREASE & OIL mg/L
			TOTAL AMMONIA mg/L	TOTAL COPPER mg/L	TOTAL COPPER ug/L	TOTAL NICKEL mg/L	TOTAL NICKEL ug/L	
0.00	1.212							
0.00	1.151	21.7	15.6					
0.00	1.119							
0.02	1.133			0.0084	8.400	0.0072	7.2	nd<4.9
0.01	0.972	22.4	19.2					
0.27	1.157							
0.10	1.131							
0.00	1.228							
0.00	1.007	25.6	21.9					
0.01	1.036							
0.00	0.980							
0.00	1.071	24.4	12					
0.41	1.042							
0.47	1.126							
0.04	1.114							
0.00	1.005	23.7	14.1					
0.00	1.029							
0.00	0.943							
0.00	0.982	26.40	11.3					
0.00	0.904							
0.00	0.904							
0.00	0.934							
0.27	0.934	27.7	16.5					
0.55	1.120							
0.13	1.048							
0.00	0.971	25	11.3					
0.10	1.000							
0.12	0.968							
0.58	0.939							
0.52	1.241							
0.12	1.158							
3.72	32.56							

0.12	1.05	24.6	15.2	0.008	8.4	0.007	7.2	<4.9
0.00	0.90	21.7	11.3	0.008	8.4	0.007	7.2	<4.9
0.58	1.24	27.7	21.9	0.008	8.4	0.007	7.2	<4.9

ECTED

NA = NOT ANALYZED

Units	METHOD USED	Daily Max	Avg. Monthly	Avg. Wkly	Inst. Max
ug/L	EPA 200.7	300			1500.000
ug/L	EPA 200.7	600			
mg/L	EPA 1664		25	40	75.0

CITY OF CRESCENT CITY WPCF - SUMMARY OF TREATMENT REPORT

DISCHARGE MONITORING - PERMIT No. CA0022756

ORDER # R1-2017-0002 ID # 1A84006ODN

Apr-20

ALL SAMPLES ARE FROM MONITORING LOCATION EFF-001 WITH EXCEPTION OF THE THREE IN BOLD MARKED INF

DAY	DAILY REQUIREMENTS						SUSPENDED SOLIDS						WEEKLY REQUIREMENTS													
	RAIN IN	INF FLOW MGD	FLOW MGD	pH	Temp.	TOTAL CL ₂ mg/L	Settleable Solids		INF mg/L	EFF mg/L	Wkly Avg (mg/L)	LBS/DAY	Wkly Avg(lb/day)	BOD 5												
							EFF	Wkly Avg(mg/L)						INF mg/L	EFF mg/L	Wkly Avg(mg/L)	LBS/DAY	Wkly Avg(lb/day)	FECAL MPN	TURB NTU	TURB Wkly Avg					
29	0.5	1.153	0.939	7.34	16.5	<0.05	0.1															5.3				
30	0.52	1.397	1.241	7.38	15.8	<0.05	<0.1																5.8			
31	0.12	1.389	1.158	7.3	16	<0.05	0.1																5.9			
1	0.02	1.320	1.109	7.26	16.0	<0.05	0.1	0.889	168	8.9		82		192	14.1		130		7.8	5.2	5.8					
2	0.00	1.266	1.017	7.46	16.2	<0.05	0.1		179	8.3	11.0	70	76	269	28.4	21.3	241	186					5.6			
3	0.17	1.238	1.021	7.32	15.8	<0.05	0.2																5.4			
4	1.410	1.397	1.190	7.30	16.2	<0.05	7.0												4.5	7.4						
5	0.430	1.835	1.669	7.36	15.4	<0.05	<0.1																7.8			
6	0.020	1.543	1.320	7.36	15.7	<0.05	<0.1		175	15.8		174		194	20.8		229		4.5	4.8						
7	0.010	1.462	1.290	7.41	16.2	<0.05	<0.1	0.131			12.4		128			18.0		185					5.1	5.5		
8	0.000	1.412	1.112	7.39	16.5	<0.05	<0.1		162	8.9		83		189	15.1		140		2.0	4.8						
9	0.010	1.355	1.129	7.37	17.0	<0.05	<0.1																4.7			
10	0.010	1.328	1.238	7.31	17.1	<0.05	0.2																6.3			
11	0.00	1.305	1.072	7.44	17.1	<0.05	<0.1												23.0	5.3						
12	0.00	1.260	1.019	7.28	17.0	<0.05	0.1																5.2			
13	0.00	1.259	1.025	7.32	16.7	<0.05	0.5		197	9.1		78		241	12.9		110		7.8	5.8						
14	0.00	1.251	1.048	7.21	17.2	<0.05	0.1				8.9		78			13.4		118				6.2	5.5			
15	0.00	1.325	1.116	7.33	17.3	<0.05	0.1	0.186	204	9.1		85		243	13.3		124		2.0	4.5						
16	0.00	1.292	1.031	7.39	17.3	<0.05	<0.1		211	8.4		72		221	14.0		120						4.5			
17	0.03	1.195	1.015	7.41	17.4	<0.05	0.3																7.6			
18	0.03	1.171	0.957	7.16	17.4	<0.05	0.1																4.8			
19	0.00	1.138	0.899	7.19	17.9	<0.05	<0.1																5.9			
20	0.00	1.123	0.917	7.21	17.3	<0.05	0.1		212	9.9		76		249	16.9		129		<1.8	4.4						
21	0.02	1.154	0.965	7.30	17.4	<0.05	<0.1				10.4		87			14.8		123				4.9	5.3			
22	0.70	1.235	1.053	7.27	17.4	<0.05	<0.1		229	11.6		102		242	14.1		124					3.9				
23	0.02	1.271	1.039	7.38	18.0	<0.05	0.2	0.114	181.0	9.7		84		238	13.4		116					5.8				
24	0.02	1.199	1.020	7.31	17.8	<0.05	<0.1												4.5	7.2						
25	0.01	1.204	0.997	7.33	18.0	<0.05	<0.1																5.1			
26	0.02	1.170	0.997	7.26	18.1	<0.05	<0.1																6			
27	0.01	1.146	0.957	7.19	18.2	<0.05	<0.1		218.0	10.5		84		240	14.4		115		4.5	4.8			6.3			
28	0.03	1.136	0.959	7.15	18.2	14.00	0.2	0.114			9.3		73			13.4		104				7.8				
29	0.16	1.161	0.946	7.30	18.7	<0.05	<0.1		200.0	8.9		70		243	13.5		107					4.6				
30	0.00	1.143	0.902	7.33	18.4	<0.05	<0.1		220.0	8.6		65		235	12.2		92					4.5				
1	0.04	1.115	0.997	7.29	17.9	<0.05	<0.1																4.4			
2	1.04	1.310	1.112	7.61	18.10	<0.05	<0.1																12			
TOTAL	3.13	38.29	32.03																(MEDIAN)							
AVG	0.10	1.28	1.07	7.31	17.16	0.30	0.245	0.29	196.62	9.82	10.39	86.48	88.59	230.46	15.62	16.15	136.71	143.16	4.5	5.53	5.69					
MIN	0.00	1.12	0.90	7.15	15.40	<0.05	<0.1	0.11	162.00	8.30	8.87	64.70	72.91	189.00	12.20	13.37	91.78	104.41	<1.8	3.90	5.31					
MAX	1.41	1.84	1.67	7.46	18.70	14.00	7.00	0.89	229.00	15.80	12.35	173.94	128.24	269.00	28.40	21.25	240.88	185.65	23.00	7.80	6.3					
DISCHARGE LIMITS:																										
INSTANT MAX.						1.8	3																225			
DAILY MAX.						0.24																				
7 DAY AVG.						1.5			45	700			45	100												
30 DAY AVG.						1			30	465			30	14			75									
DAILY MAX. OF 10% pH						6.0/9.0																		43		
SIX MONTH MEDIAN						0.06																				
TSS 85% REMOVAL										BOD 85% REMOVAL																
TOTAL RAINFALL (year-to-date):									23.73	CALCULATED % REMOVALS			TSS	95.00	BOD	93.22	Temperature limit exceeded									

CITY OF CRESCENT CITY WPCF - SUMMARY OF TREATMENT REPORT

DISCHARGE MONITORING - PERMIT No. CA0022756

ORDER # R1-2017-0002 ID # 1A84006ODN

Apr-20

ALL SAMPLES ARE FROM MONITORING LOCATION EFF-001 WITH EXCEPTION OF THE
THREE IN BOLD MARKED INF

DAY	RAIN IN	FLOW MGD	INF TOTAL AMMONIA mg/L	ONE SAMPLE PER MONTH REQUIRED					GREASE & OIL mg/L
				TOTAL AMMONIA mg/L	TOTAL COPPER mg/L	TOTAL COPPER ug/L	TOTAL NICKEL mg/L	TOTAL NICKEL ug/L	
29	0.5	0.939							
30	0.52	1.241							
31	0.12	1.158							
1	0.02	1.109							
2	0.00	1.017	23.2	15.0					
3	0.17	1.021	25.7	9.89					
4	1.41	1.190							
5	0.43	1.669							
6	0.02	1.320	17.1	12.5					
7	0.01	1.290							
8	0.00	1.112							
9	0.01	1.129		6.74	0.0066	6.6	0.008	8.1	nd<5.2
10	0.01	1.238	23.3	7.99					
11	0.00	1.072							
12	0.00	1.019							
13	0.00	1.025	23.2	8.95					
14	0.00	1.048							
15	0.00	1.116							
16	0.00	1.031	18.9	9.79					
17	0.03	1.015							
18	0.03	0.957							
19	0.00	0.899							
20	0.00	0.917	25.6	7.61					
21	0.02	0.965							
22	0.70	1.053							
23	0.02	1.039	25.1	7.8					
24	0.02	1.020							
25	0.01	0.997							
26	0.02	0.997							
27	0.01	0.957	25.8	11.3					
28	0.03	0.959							
29	0.16	0.946							
30	0.00	0.902	21.5	5.93					
31	0.04	0.997							
1	1.04	1.112							
	3.13	32.03							
AVG	0.10	1.07	22.94	9.41	0.007	6.60	0.008	8.10	<5.2
MIN	0.00	0.90	17.10	5.93	0.007	6.60	0.008	8.10	<5.2
MAX	1.41	1.67	25.8	15.0	0.007	6.60	0.008	8.10	<5.2

ND = NON DETECTED

NA = NOT ANALYZED

ANALYTE	Units	METHOD USED	Daily Max	Avg. Monthly	Avg. Wkly	Inst. Max
TOTAL COPPER	ug/L	EPA 200.7	300			1500,000
TOTAL NICKEL	ug/L	EPA 200.7	600			
GREASE & OIL	mg/L	EPA 1664		25	40	75.0

CITY OF CRESCENT CITY WPCF - SUMMARY OF TREATMENT REPORT

DISCHARGE MONITORING - PERMIT No. CA0022756

ORDER # R1-2017-0002 ID # 1A84006ODN

May-20

ALL SAMPLES ARE FROM MONITORING LOCATION EFF-001 WITH EXCEPTION OF THE THREE IN BOLD MARKED INF

DAY	DAILY REQUIREMENTS						WEEKLY REQUIREMENTS															
	RAIN IN	INF FLOW MGD	FLOW MGD	pH	Temp.	TOTAL CL ₂ mg/L	Settleable Solids		SUSPENDED SOLIDS					BOD 5					FECAL MPN	TURB NTU	TURB Wkly Avg	
							EFF	Wkly Avg(mg/L)	INF mg/L	EFF mg/L	Wkly Avg (mg/L)	LBS/DAY	Wkly Avg(lb/day)	INF mg/L	EFF mg/L	Wkly Avg(mg/L)	LBS/DAY	Wkly Avg(lb/day)				
30	0	1.143	0.902	7.61	18.1	<0.05	<0.1	x	220	8.6	x	65	x	235	12.2	x	92	x		4.5	x	
1	0.04	1.115	0.997	7.29	17.9	<0.05	<0.1													4.4		
2	1.04	1.31	1.112	7.61	18.1	<0.05	<0.1												130	12		
3	0.01	1.207	0.971	7.31	17.70	<0.05	<0.1													3.8		
4	0.00	1.165	0.928	7.24	17.70	<0.05	<0.1		215	9.9		77		208	12.7		98		22.0	3.9		
5	0.15	1.168	0.999	7.11	18.00	<0.05	<0.1				8.8					13.0		100		5.4	4.8	
6	0.030	1.174	0.948	7.05	17.90	<0.05	0.1	0.157					68						11.0	5.2		
7	0.020	1.158	0.916	7.25	18.20	<0.05	<0.1		212	7.7		59		232	13.3		102			4.9		
8	0.000	1.138	0.948	7.31	18.80	<0.05	0.3													5.9		
9	0.000	1.110	0.886	7.18	18.80	<0.05	0.3												49.0	4.8		
10	0.000	1.092	0.892	7.21	18.80	<0.05	<0.1													4.2		
11	0.540	1.153	0.944	7.30	18.30	<0.05	<0.1		176	5.0		39		221	15.3		120		11.0	4.5		
12	0.570	1.302	1.146	7.36	18.10	<0.05	<0.1	0.114			9.2		88			15.6		145		6.3		
13	0.45	1.270	1.116	7.22	18.10	<0.05	<0.1		204	12.2		114		215	17.4		162			5.6	5.6	
14	0.80	1.497	1.292	7.39	18.40	<0.05	<0.1		194	10.4		112		209	14.2		153		<1.8	5.8		
15	0.02	1.333	1.133	7.38	19.00	<0.05	0.1												1.8	6.8		
16	0.51	1.385	1.189	7.22	18.80	<0.05	0.2												13.0	6.1		
17	0.85	1.535	1.334	7.16	18.50	<0.05	<0.1												13.0	6.1		
18	0.01	1.568	1.377	7.28	17.70	<0.05	<0.1		152	11.5		132		155	16.8		193		2.0	6		
19	0.02	1.436	1.191	7.30	18.30	<0.05	<0.1				9.4					14.6			2.0	5.3		
20	0.02	1.385	1.170	7.31	18.60	<0.05	<0.1	<0.1	175	9.8		96		162	13.3		130	149	2.0	5.2	5.5	
21	0.00	1.332	1.088	7.34	18.60	<0.05	<0.1		162	7.0		64	97	183	13.6		123		7.8	5.1		
22	0.00	1.327	1.121	7.41	18.20	<0.05	<0.1												2.0	6.1		
23	0.00	1.278	1.026	7.38	18.40	<0.05	<0.1												23.0	4.8		
24	0.00	1.242	1.027	7.33	18.60	<0.05	<0.1												<1.8	5.9		
25	0.00	1.270	1.018	7.32	19.10	<0.05	<0.1		208	6.6		56	65	224	12.1	12.8	103		7.8	4.3		
26	0.00	1.244	1.025	7.31	19.00	<0.05	<0.1	0.100										108	2.0	5.5	5.7	
27	0.00	1.227	1.026	7.35	19.20	<0.05	<0.1		190	8.5	7.7	73		250	13.5		116		6.8	5.1		
28	0.01	1.222	0.979	7.41	19.30	<0.05	<0.1		190	8.0		65		221	12.9		105		13.0	5.2		
29	0.30	1.219	1.016	7.45	19.30	<0.05	0.1													7.8		
30	1.25	1.486	1.299	7.48	18.80	<0.05	0.2													6.1		
31	0.01	1.370	1.175	7.37	18.60	<0.05	<0.1													9.6		
TOTAL	6.65	39.72	33.29																			

(MEDIAN)																						
AVG	0.21	1.28	1.07	7.31	18.48	<0.05	0.119	0.124	188.91	8.78	8.78	80.52	79.45	207.27	14.10	14.01	127.73	125.41	7.8	5.7	5.4	
MIN	0.00	1.09	0.89	7.05	17.70	<0.05	<0.1	<0.1	152.00	5.00	7.70	39.36	64.70	155.00	12.10	12.83	98.29	99.95	<1.8	3.8	4.8	
MAX	1.25	1.57	1.38	7.61	19.30	<0.05	0.30	0.16	215.00	12.20	9.43	132.07	97.07	250.00	17.40	15.63	192.93	148.71	130.00	12.00	5.7	
DISCHARGE LIMITS:																						
INSTANT MAX.						1.8	3													225		
DAILY MAX.						0.24																
7 DAY AVG.							1.5			45		700		45						100		
30 DAY AVG.							1			30		465		30						14	75	
DAILY MAX. OF 10%								1												43		
pH				6.0/9.0																		
SIX MONTH MEDIAN						0.06																
										TSS 85% REMOVAL					BOD 85% REMOVAL							
TOTAL RAINFALL (year-to-date):								37.03		CALCULATED % REMOVALS											Temperature limit exceeded	
										TSS 95.35					BOD 93.20							

CITY OF CRESCENT CITY WPCF - SUMMARY OF TREATMENT REPORT

DISCHARGE MONITORING - PERMIT No. CA0022756

ORDER # R1-2017-0002 ID # 1A84006ODN

May-20

ALL SAMPLES ARE FROM MONITORING LOCATION EFF-001 WITH EXCEPTION OF THE
THREE IN BOLD MARKED INF

DAY	RAIN IN	FLOW MGD	INF TOTAL AMMONIA mg/L	ONE SAMPLE PER MONTH REQUIRED					GREASE & OIL mg/L
				TOTAL AMMONIA mg/L	TOTAL COPPER mg/L	TOTAL COPPER ug/L	TOTAL NICKEL mg/L	TOTAL NICKEL ug/L	
30	0	0.902	21.5	5.93					
1	0.04	0.997							
2	1.04	1.112							
3	0.01	0.971							
4	0.00	0.928	24.1	7.66					
5	0.15	0.999							
6	0.030	0.948							
7	0.020	0.916	26.6	5.8	0.0095	9.500	0.0077	7.7	<4.8
8	0.000	0.948							
9	0.000	0.886							
10	0.000	0.892							
11	0.540	0.944	30.6	6.6					
12	0.570	1.146							
13	0.45	1.116							
14	0.80	1.292	25.2	7.81					
15	0.02	1.133							
16	0.51	1.189							
17	0.85	1.334							
18	0.01	1.377	18.0	6.6					
19	0.02	1.191							
20	0.02	1.170							
21	0.00	1.088	21.9	9.48					
22	0.00	1.121							
23	0.00	1.026							
24	0.00	1.027							
25	0.00	1.018	29.5	10.5					
26	0.00	1.025							
27	0.00	1.026							
28	0.01	0.979	24.6	7.0					
29	0.30	1.016							
30	1.25	1.299							
31	0.01	1.175							
TOTAL	6.65	33.29							

AVG	0.21	1.07	25.06	7.67	0.0095	9.5	0.0077	7.7	<4.8
MIN	0.00	0.89	18.00	5.75	0.0095	9.5	0.0077	7.7	<4.8
MAX	1.25	1.38	30.60	10.50	0.0095	9.5	0.0077	7.7	<4.8

ND = NON DETECTED

NA = NOT ANALYZED

ANALYTE	Units	METHOD USED	Daily Max	Avg. Monthly	Avg. Wkly	Inst. Max
TOTAL COPPER	ug/L	EPA 200.7	300			1500.000
TOTAL NICKEL	ug/L	EPA 200.7	600			
GREASE & OIL	mg/L	EPA 1664		25	40	75.0

CITY OF CRESCENT CITY WPCF - SUMMARY OF TREATMENT REPORT

DISCHARGE MONITORING - PERMIT No. CA0022756

ORDER # R1-2017-0002 ID # 1A84006ODN

Jun-20

ALL SAMPLES ARE FROM MONITORING LOCATION EFF-001 WITH EXCEPTION OF THE THREE IN BOLD MARKED INF

DAY	DAILY REQUIREMENTS						WEEKLY REQUIREMENTS														
	RAIN IN	INF FLOW MGD	FLOW MGD	pH	Temp.	TOTAL CL ₂ mg/L	Settleable Solids		SUSPENDED SOLIDS					BOD 5					FECAL MPN	TURB NTU	TURB Wkly Avg
							EFF	Wkly Avg(mg/L)	INF mg/L	EFF mg/L	Wkly Avg (mg/L)	LBS/DAY	Wkly Avg(lb/day)	INF mg/L	EFF mg/L	Wkly Avg(mg/L)	LBS/DAY	Wkly Avg(lb/day)			
31	0.01	1.370	1.175	7.37	18.60	<0.05	<0.1													9.6	
1	0.00	1.295	1.041	7.27	18.9	<0.05	<0.1		162	11.2	10.2	97	86	192	14.3	13.3	124	112	4.5	4.8	6.1
2	0.00	1.281	1.076	7.21	18.90	<0.05	<0.1	0.100												5.6	
3	0.00	1.248	1.016	7.34	19.40	<0.05	<0.1		165	10.0		85		206	12.7		108		4.5	5	
4	0.00	1.248	0.975	7.33	19.10	<0.05	<0.1		178	9.4		76		236	12.8		104			5	
5	0.00	1.205	1.033	7.45	18.80	<0.05	0.1													7.9	
6	0.10	1.201	0.969	7.38	19.40	<0.05	0.1												2.0	4.7	
7	0.05	1.192	0.943	7.33	19.00	<0.05	<0.1	0.100			8.2		66			11.1		88		4.8	4.8
8	0.00	1.193	0.987	7.37	19.00	<0.05	<0.1		227	8.4		69		276	11.5		95		17.0	4.6	
9	0.00	1.197	0.928	7.28	19.60	<0.05	0.1													5.5	
10	0.00	1.165	0.961	7.36	20.30	<0.05	<0.1		205.0	7.8		63		212.0	10.0		80		4.5	4	
11	0.00	1.157	0.921	7.39	20.40	<0.05	<0.1		225	8.5		65		228	11.7		90			4.2	
12	0.00	1.179	1.001	7.32	20.10	<0.05	0.1													5.8	
13	0.00	1.168	0.909	7.28	19.80	<0.05	<0.1												4.5	4.5	
14	0.16	1.134	0.894	7.23	20.30	<0.05	0.1				7.5		57			11.3		86		4.2	4.6
15	0.30	1.173	0.966	7.22	20.00	<0.05	0.1	0.140	186.0	7.1		57		213.0	10.3		83		6.8	3.6	
16	0.30	1.183	0.991	7.13	19.60	<0.05	0.1													6.1	
17	0.01	1.152	0.919	7.26	20.20	<0.05	<0.1		198	7.6		58		243	12.4		95		4.5	3.8	
18	0.00	1.141	0.867	7.39	20.20	<0.05	<0.1		202	7.8		56		241	11.2		81			4	
19	0.00	1.133	0.848	7.09	20.60	<0.05	0.2													5.3	
20	0.00	1.134	0.932	7.30	20.40	<0.05	0.3													5.5	
21	0.00	1.104	0.919	7.21	20.60	<0.05	0.2				9.4		70			12.2		91		4.1	5.3
22	0.00	1.122	0.886	7.35	20.60	<0.05	<0.1		214	10.3		76		242	12.3		91		<1.8	5.9	
23	0.00	1.132	0.900	7.47	21.10	<0.05	<0.1	0.130												4.3	
24	0.00	1.130	0.939	7.29	20.70	<0.05	0.1		204	8.2		64		280	11.4		89			5.2	
25	0.00	1.117	0.854	7.38	21.00	<0.05	<0.1		215	9.7		69		274	13.0		93			4.1	
26	0.00	1.104	0.915	7.13	20.60	<0.05	0.2													8.4	
27	0.00	1.113	0.909	7.19	20.70	<0.05	0.1													5.3	
28	0.00	1.112	0.892	7.22	20.40	<0.05	0.1													5.7	
29	0.00	1.102	0.865	7.33	20.20	<0.05	0.1		218	10.8		78		262	14.6		105		17.0	3	
30	0.00	1.103	0.911	7.11	20.40	<0.05	0.1													5	
TOTAL	0.92	34.92	28.17																		

(MEDIAN)

AVG	0.03	1.16	0.94	7.29	20.01	<0.05	0.117	0.12	199.92	8.98	8.83	70.35	69.72	238.85	12.17	11.97	95.20	94.36	4.5	5.00	5.21
MIN	0.00	1.10	0.85	7.09	18.80	<0.05	<0.1	0.10	162.00	7.10	7.50	56.40	57.28	192.00	10.00	11.07	80.15	86.34	<1.8	3.00	4.64
MAX	0.30	1.30	1.08	7.47	21.10	<0.05	0.30	0.14	227.00	11.20	10.20	97.24	86.14	280.00	14.60	13.27	124.15	111.95	17.00	8.40	6.09

(MEDIAN)

DISCHARGE LIMITS:																					
INSTANT MAX.						1.8	3													225	
DAILY MAX.						0.24															
7 DAY AVG.							1.5			45		700		45						100	
30 DAY AVG.							1			30		465		30					14	75	
DAILY MAX. OF 10%											1								43		
pH				6.0/9.0																	
SIX MONTH MEDIAN						0.06															

TSS 85% REMOVAL

BOD 85% REMOVAL

TOTAL RAINFALL (year-to-date):

37.95

CALCULATED % REMOVALS

TSS 95.51

BOD 94.90

Temperature limit exceeded

CITY OF CRESCENT CITY WPCF - SUMMARY OF TREATMENT REPORT

DISCHARGE MONITORING - PERMIT No. CA0022756

ORDER # R1-2017-0002 ID # 1A84006ODN

Jun-20

ALL SAMPLES ARE FROM MONITORING LOCATION EFF-001 WITH EXCEPTION OF THE THREE IN BOLD MARKED INF

DAY	RAIN IN	FLOW MGD	INF TOTAL AMMONIA mg/L	ONE SAMPLE PER MONTH REQUIRED					
				TOTAL AMMONIA mg/L	TOTAL COPPER mg/L	TOTAL COPPER ug/L	TOTAL NICKEL mg/L	TOTAL NICKEL ug/L	GREASE & OIL mg/L
31	0.01	1.175							
1	0.00	1.041	23.1	10.3					
2	0.00	1.076							
3	0.00	1.016							
4	0.00	0.975	22.4	6.83					
5	0.00	1.033							
6	0.10	0.969							
7	0.05	0.943							
8	0.00	0.987	25.5	6.77					
9	0.00	0.928							
10	0.00	0.961			0.014	14	0.009	8.8	nd<4.6
11	0.00	0.921	27.0	7.89					
12	0.00	1.001							
13	0.00	0.909							
14	0.16	0.894							
15	0.30	0.966	27.8	6.18					
16	0.30	0.991							
17	0.01	0.919							
18	0.00	0.867	23.8	5.58					
19	0.00	0.848							
20	0.00	0.932							
21	0.00	0.919							
22	0.00	0.886	27.2	6.8					
23	0.00	0.900							
24	0.00	0.939							
25	0.00	0.854	27.1	9.6					
26	0.00	0.915							
27	0.00	0.909							
28	0.00	0.892							
29	0.00	0.865	29.3	11.5					
30	0.00	0.911							
TOTAL	0.92	28.17							

AVG	0.03	0.94	25.91	7.94	0.014	14.0	0.009	8.8	<4.6
MIN	0.00	0.85	22.40	5.58	0.014	14.0	0.009	8.8	<4.6
MAX	0.30	1.08	29.30	11.50	0.014	14.0	0.009	8.8	<4.6

ND = NON DETECTED

NA = NOT ANALYZED

ANALYTE	Units	METHOD USED	Daily Max	Avg. Monthly	Avg. Wkly	Inst. Max
TOTAL COPPER	ug/L	EPA 200.7	300			1500.000
TOTAL NICKEL	ug/L	EPA 200.7	600			
GREASE & OIL	mg/L	EPA 1664		25	40	75.0

CITY OF CRESCENT CITY WPCF - SUMMARY OF TREATMENT REPORT

DISCHARGE MONITORING - PERMIT No. CA0022756

ORDER # R1-2017-0002 ID # 1A84006ODN

Jul-20

ALL SAMPLES ARE FROM MONITORING LOCATION EFF-001 WITH EXCEPTION OF THE THREE IN BOLD MARKED INF

DAY	DAILY REQUIREMENTS							WEEKLY REQUIREMENTS													
	RAIN IN	INF FLOW MGD	FLOW MGD	pH	Temp.	TOTAL CL ₂ mg/L	Settleable Solids		SUSPENDED SOLIDS					BOD 5					FECAL MPN*	TURB NTU	TURB Wkly Avg
							EFF	Wkly Avg(mg/L)	INF mg/L	EFF mg/L	Wkly Avg (mg/L)	LBS/DAY	Wkly Avg(lb/day)	INF mg/L	EFF mg/L	Wkly Avg(mg/L)	LBS/DAY	Wkly Avg(lb/day)			
28	0.00	1.112	0.892	7.22	20.4	<0.05	0.1		218	10.8		78		262	14.6		105		5.7		
29	0.00	1.102	0.865	7.33	20.2	<0.05	0.1												3		
30	0.00	1.103	0.911	7.11	20.4	<0.05	0.1												5		
1	0.00	1.113	0.875	7.28	20.3	<0.05	<0.1		209	10.7		78		248	12.2		89	22.0	3.3		
2	0.00	1.122	0.910	7.28	20.4	<0.05	0.1	0.143	196	6.7	9.4	51	69	250	10.4	12.4	79	91	4.8	4.9	
3	0.00	1.085	0.870	7.10	20.3	<0.05	0.2												6		
4	0.00	1.025	0.826	7.22	20.7	<0.05	0.3												6.8		
5	0.00	1.090	0.875	7.15	20.5	<0.05	0.1												3.8		
6	0.00	1.106	0.866	7.24	20.6	<0.05	<0.1		237	14.1		102		280	13.7		99	110.0	4.4		
7	0.00	1.100	0.898	7.29	21.0	<0.05	<0.1	0.143											4		
8	0.00	1.093	0.872	7.24	21.0	<0.05	0.1		213	9.6		70		259	12.4		90	13.0	4.1	4.6	
9	0.00	1.111	0.917	7.41	20.8	<0.05	0.1		223	10.9	11.5	83	85	276	13.0	13.0	99	96	4.3		
10	0.00	1.122	0.899	7.04	21.1	<0.05	0.3												7.4		
11	0.00	1.092	0.877	7.41	21.1	<0.05	0.2												2.0	4.5	
12	0.00	1.073	0.881	7.31	21.1	<0.05	<0.1												3.4		
13	0.00	1.045	0.808	7.26	20.9	<0.05	<0.1	0.100	217	7.0		47		264	9.8		66	33.0	3.5		
14	0.00	1.092	0.883	7.27	20.7	<0.05	0.1												4.1	4.0	
15	0.00	1.075	0.823	7.31	20.9	<0.05	0.1		229	6.7		46		232	10.5		72	23.0	3.5		
16	0.00	1.069	0.840	7.39	21.1	<0.05	<0.1		222	8.7	7.5	61	51	258	9.8	10.0	69	69	3.6		
17	0.00	1.062	0.880	7.40	21.3	<0.05	0.1												5.5		
18	0.00	1.063	0.890	7.45	21.3	<0.05	<0.1												4.2		
19	0.00	1.065	0.759	7.32	21.5	<0.05	<0.1												4.0	3.5	
20	0.01	1.077	0.695	7.23	20.6	<0.05	<0.1		206	9.3		54		239	18.0		104	350.0	3.4		
21	0.02	1.090	0.765	7.35	20.8	<0.05	<0.1	0.243											4.1	5.3	
22	0.00	1.070	0.858	7.33	21.3	<0.05	<0.1		314	9.5		68		334	16.0		114	7.8	3.8		
23	0.00	1.053	0.769	7.28	21.2	<0.05	<0.1		296.0	12.1	10.3	78	66	339	18.0	17.3	115	111	4.0	4.2	
24	0.00	1.081	0.767	7.25	21.2	<0.05	1.1												4.5	12	
25	0.00	1.099	0.757	7.33	21.2	<0.05	<0.1												2.0	6.3	
26	0.00	1.042	0.764	7.17	21.3	<0.05	<0.1												4.0	4.4	
27	0.00	1.054	0.726	7.25	20.9	<0.05	<0.1		314.0	10.1		61		294	16.4		99	13.0	4	4.7	
28	0.00	1.060	0.780	7.37	20.8	<0.05	<0.1	0.100											4.5	5.2	
29	0.00	1.061	0.752	7.37	21.1	<0.05	<0.1		406.0	10.4		65		437	20.7		130	49.0	4.7		
30	0.00	1.083	0.835	7.35	21.5	<0.05	0.1		214.0	10.8	10.4	75	67	272	22.0	19.7	153	127	7.8	4.4	
31	0.00	1.049	0.752	7.34	21.4	<0.05	<0.1												5.2		
1	0.00	1.032	0.798	7.33	21.60	<0.05	0.1												4.7		
TOTAL	0.03	33.42	25.67																		

(median)

AVG	0.00	1.08	0.83	7.29	20.98	<0.05	0.22	0.152	249.71	9.76	9.83	67.08	67.80	284.43	14.49	14.50	98.56	99.01	7.8	4.72	4.71
MIN	0.00	1.03	0.70	7.04	20.30	<0.05	0.10	<0.1	196.00	6.70	7.47	45.99	51.37	232.00	9.80	10.03	66.04	68.92	2.00	3.30	3.97
MAX	0.02	1.12	0.92	7.45	21.60	<0.05	1.10	0.24	406.00	14.10	11.53	101.84	85.00	437.00	22.00	19.70	153.21	127.44	350.00	12.00	5.33

DISCHARGE LIMITS:																					
INSTANT MAX.						1.8	3													225	
DAILY MAX.						0.24															
7 DAY AVG.							1.5			45		700			45					100	
30 DAY AVG.							1			30		465			30				14	75	
DAILY MAX. OF 10%								1											43		
pH				6.0/9.0																	
SIX MONTH MEDIAN						0.06															

TOTAL RAINFALL (year-to-date):

37.98

TSS 85% REMOVAL

BOD 85% REMOVAL

TSS 96.09

CALCULATED % REMOVALS

BOD 94.90

icy sample low volume Temperature limit exceeded

* see attached sheet for additional fecal MPN results

CITY OF CRESCENT CITY WPCF - SUMMARY OF TREATMENT REPORT

DISCHARGE MONITORING - PERMIT No. CA0022756

ORDER # R1-2017-0002 ID # 1A84006ODN

Jul-20

ALL SAMPLES ARE FROM MONITORING LOCATION EFF-001 WITH EXCEPTION OF THE
THREE IN BOLD MARKED INF

DAY	RAIN IN	FLOW MGD	INF TOTAL AMMONIA mg/L	ONE SAMPLE PER MONTH REQUIRED					GREASE & OIL mg/L
				TOTAL AMMONIA mg/L	TOTAL COPPER mg/L	TOTAL COPPER ug/L	TOTAL NICKEL mg/L	TOTAL NICKEL ug/L	
28	0	0.892							
29	0	0.865	29.30	11.50					
30	0	0.911							
1	0.00	0.875							
2	0.00	0.910	27.30	4.12					
3	0.00	0.870							
4	0.00	0.826							
5	0.00	0.875							
6	0.00	0.866	34.20	9.99					
7	0.00	0.898							
8	0.00	0.872							
9	0.00	0.917	27.80	7.80	0.014	14	0.008	8.1	<5.0
10	0.00	0.899							
11	0.00	0.877							
12	0.00	0.881							
13	0.00	0.808	32.80	13.30					
14	0.00	0.883							
15	0.00	0.823							
16	0.00	0.840	30.20	5.98					
17	0.00	0.880							
18	0.00	0.890							
19	0.00	0.759							
20	0.01	0.695	32.00	7.49					
21	0.02	0.765							
22	0.00	0.858	30.10	6.68					
23	0.00	0.769							
24	0.00	0.767							
25	0.00	0.757							
26	0.00	0.764							
27	0.00	0.726	28.40	10.70					
28	0.00	0.780							
29	0.00	0.752							
30	0.00	0.835	34.80	5.76					
31	0.00	0.752							
1	0.00	0.798							

AVG	0.00	0.83	30.84	7.98	0.0	14.0	0.0	8.1	<5.0
MIN	0.00	0.70	27.30	4.12	0.0	14.0	0.0	8.1	<5.0
MAX	0.02	0.92	34.80	13.30	0.0	14.0	0.0	8.1	<5.0

ND = NON DETECTED

NA = NOT ANALYZED

ANALYTE	Units	METHOD USED	Daily Max	Avg. Monthly	Avg. Wkly	Inst. Max
TOTAL COPPER	ug/L	EPA 200.7	300			1500.000
TOTAL NICKEL	ug/L	EPA 200.7	600			
GREASE & OIL	mg/L	EPA 1664		25	40	75.0

CITY OF CRESCENT CITY WPCF - SUMMARY OF TREATMENT REPORT

DISCHARGE MONITORING - PERMIT No. CA0022756

ORDER # R1-2017-0002 ID # 1A84006ODN

Aug-20

ALL SAMPLES ARE FROM MONITORING LOCATION EFF-001 WITH EXCEPTION OF THE THREE IN BOLD MARKED INF

DAY	DAILY REQUIREMENTS						WEEKLY REQUIREMENTS															
	RAIN IN	INF FLOW MGD	FLOW MGD	pH	Temp.	TOTAL CL ₂ mg/L	Settleable Solids		SUSPENDED SOLIDS				BOD 5				FECAL MPN	TURB NTU	TURB Wkly Avg			
							EFF	Wkly Avg(mL/L)	INF mg/L	EFF mg/L	Wkly Avg (mg/L)	LBS/DAY	Wkly Avg(lb/day)	INF mg/L	EFF mg/L	Wkly Avg(mg/L)				LBS/DAY	Wkly Avg(lb/day)	
1	0.00	1.032	0.798	7.33	21.6	<0.05	0.1	x				x				x			4.7	x		
2	0.00	1.062	0.772	7.38	21.6	<0.05	0.1												5.5			
3	0.01	1.041	0.797	7.32	22.1	<0.05	<0.1	0.157	324	14.5		96		400	21.0		140		4.5	5.4	6.0	
4	0.000	1.047	0.794	7.38	21.9	<0.05	0.1				15.9		102			23.5		151		6.8		
5	0.000	1.051	0.769	7.41	22.1	<0.05	0.1		348	15.0		96		427	20.0		128		23.0	4.9		
6	0.000	1.074	0.751	7.38	21.9	<0.05	0.1		286	18.3		115		312	29.6		185			6.5		
7	0.000	1.041	0.842	7.28	22.0	<0.05	0.4													6.6		
8	0.000	1.051	0.815	7.37	21.9	<0.05	0.2												6.8	6.1		
9	0.000	1.009	0.738	7.35	21.9	<0.05	0.1													4.8		
10	0.000	0.994	0.746	7.24	21.6	<0.05	0.2		376	14.9		93		342	16.1		100		<1.8	3.6	5.1	
11	0.01	1.024	0.749	7.17	21.2	<0.05	0.2	0.186			15.3		97			16.6		105		6.2		
12	0.00	1.035	0.788	7.36	20.7	<0.05	0.2		320	12.8		84		402	14.1		93		<1.8	4.3		
13	0.00	1.043	0.749	7.35	21.5	<0.05	0.1		289	18.1		113		351	19.7		123			4		
14	0.00	1.027	0.773	7.32	21.8	<0.05	0.2													6.9		
15	0.00	1.042	0.761	7.30	22.5	<0.05	0.3													22.0	5.8	
16	0.00	1.030	0.806	7.23	22.3	<0.05	0.2													4.8		
17	0.00	1.024	0.747	7.33	22.2	<0.05	0.1	0.171	241	14.4		90		287	17.8		111		2.0	3.3	5.0	
18	0.02	1.030	0.819	7.21	21.6	<0.05	0.1				15.4		97			16.4		103		4.7		
19	0.00	1.035	0.766	7.44	21.8	<0.05	0.1		253	14.5		93		304	17.3		111		3.7	3.7		
20	0.00	1.031	0.748	7.42	22.1	<0.05	<0.1		418	17.2		107		335	14.1		88			3.8		
21	0.04	1.052	0.864	7.25	22.6	<0.05	0.3													7.7		
22	0.01	1.045	0.772	7.33	22.3	<0.05	0.3													7		
23	0.01	1.026	0.781	7.28	21.8	<0.05	0.1													5.2		
24	0.00	1.024	0.756	7.35	21.3	<0.05	<0.1	0.129	382.0	12.7		80		343	17.3		109		2.0	4.2	5.2	
25	0.00	1.039	0.830	7.33	21.5	<0.05	0.1				13.6		88			17.2		111		6.6		
26	0.00	1.022	0.772	7.34	21.8	<0.05	0.1		365.0	15.0		97		383	17.5		113			4.2		
27	0.00	1.034	0.790	7.45	21.5	<0.05	<0.1		360.0	13.1		86		348	16.9		111			4.4		
28	0.00	0.994	0.806	7.39	21.6	<0.05	0.3													7		
29	0.00	0.997	0.765	7.42	21.5	<0.05	0.1													4.6		
30	0.00	0.998	0.800	7.46	21.4	<0.05	0.1													3.4		
31	0.00	0.985	0.755	7.29	21.6	<0.05	0.1		435.0	9.8	x	62	x	354	12.6	x	79	x	46.0	3.6	x	
TOTAL	0.10	31.94	24.22																			
(MEDIAN)																						
AVG	0.00	1.03	0.78	7.34	21.78	<0.05	0.155	0.16	338.23	14.64	15.04	93.18	95.81	352.92	18.00	18.45	114.69	117.63	4.1	5.17	5.31	
MIN	0.00	0.99	0.74	7.17	20.70	<0.05	0.100	0.13	241.00	9.80	13.60	61.71	87.65	287.00	12.60	16.40	79.34	103.12	<1.8	3.30	5.00	
MAX	0.04	1.07	0.86	7.46	22.60	<0.05	0.400	0.19	435.00	18.30	15.93	114.62	102.40	427.00	29.60	23.53	185.39	151.08	46.00	7.70	5.97	
(MEDIAN)																						
DISCHARGE LIMITS:																						
INSTANT MAX.						1.8	3													225		
DAILY MAX.						0.24																
7 DAY AVG.							1.5			45		700		45						100		
30 DAY AVG.							1			30		465		30					14	75		
DAILY MAX. OF 10%								1											43			
pH				6.0/9.0																		
SIX MONTH MEDIAN						0.06																
TSS 85% REMOVAL										BOD 85% REMOVAL												
TOTAL RAINFALL (year-to-date):						38.08	CALCULATED % REMOVALS						Temperature limit exceeded									
							TSS 95.93						BOD 95.61									

CITY OF CRESCENT CITY WPCF - SUMMARY OF TREATMENT REPORT

DISCHARGE MONITORING - PERMIT No. CA0022756

ORDER # R1-2017-0002 ID # 1A84006ODN

Aug-20

ALL SAMPLES ARE FROM MONITORING LOCATION EFF-001 WITH EXCEPTION OF THE
THREE IN BOLD MARKED INF

DAY	RAIN IN	FLOW MGD	INF TOTAL AMMONIA mg/L	ONE SAMPLE PER MONTH REQUIRED					
				TOTAL AMMONIA mg/L	TOTAL COPPER mg/L	TOTAL COPPER ug/L	TOTAL NICKEL mg/L	TOTAL NICKEL ug/L	GREASE & OIL mg/L
1	0.00	0.798							
2	0.00	0.772							
3	0.01	0.797	33.9	6.85					
4	0.00	0.794							
5	0.00	0.769							
6	0.00	0.751	30.0	5.1	0.017	17	0.0065	6.5	<5.1
7	0.00	0.842							
8	0.00	0.815							
9	0.00	0.738							
10	0.00	0.746	30.1	5.5					
11	0.01	0.749							
12	0.00	0.788							
13	0.00	0.749	28.2	6.91					
14	0.00	0.773							
15	0.00	0.761							
16	0.00	0.806							
17	0.00	0.747	30.1	8.21					
18	0.02	0.819							
19	0.00	0.766							
20	0.00	0.748	27.6	3.36					
21	0.04	0.864							
22	0.01	0.772							
23	0.01	0.781							
24	0.00	0.756	29.7	6.23					
25	0.00	0.830							
26	0.00	0.772							
27	0.00	0.790	28.5	5.39					
28	0.00	0.806							
29	0.00	0.765							
30	0.00	0.800							
31	0.00	0.755	32.3	9.15					
TOTAL	0.10	24.22							
AVG	0.00	0.78	30.0	6.3	0.0	17.0	0.0	6.5	<5.1
MIN	0.00	0.74	27.60	3.36	0.0	17.0	0.0	6.5	<5.1
MAX	0.04	0.86	33.90	9.15	0.0	17.0	0.0	6.5	<5.1

ND = NON DETECTED

NA = NOT ANALYZED

ANALYTE	Units	METHOD USED	Daily Max	Avg. Monthly	Avg. Wkly	Inst. Max
TOTAL COPPER	ug/L	EPA 200.7	300			1500.000
TOTAL NICKEL	ug/L	EPA 200.7	600			
GREASE & OIL	mg/L	EPA 1664		25	40	75.0

CITY OF CRESCENT CITY WPCF - SUMMARY OF TREATMENT REPORT

DISCHARGE MONITORING - PERMIT No. CA0022756

ORDER # R1-2017-0002 ID # 1A84006ODN

Sep-20

ALL SAMPLES ARE FROM MONITORING LOCATION EFF-001 WITH EXCEPTION OF THE
THREE IN BOLD MARKED INF

DAY	RAIN IN	FLOW MGD	INF TOTAL AMMONIA mg/L	ONE SAMPLE PER MONTH REQUIRED					
				TOTAL AMMONIA mg/L	TOTAL COPPER mg/L	TOTAL COPPER ug/L	TOTAL NICKEL mg/L	TOTAL NICKEL ug/L	GREASE & OIL mg/L
30	0.00	0.800							
31			32.3	9.15					
1	0.01	0.793							
2	0.01	0.741							
3	0.00	0.765	32.3	4.78	0.017	17.0	0.006	6.1	<4.9
4	0.00	0.859							
5	0.00	0.768							
6	0.00	0.722							
7	0.00	0.791	37.2	6.26					
8	0.00	0.730							
9	0.00	0.797							
10	0.00	0.781	33.3	7.78					
11	0.00	0.803							
12	0.00	0.778							
13	0.00	0.804							
14	0.00	0.775	29.7	8.12					
15	0.00	0.846							
16	0.02	0.773							
17	0.01	0.753	28.9	4.41					
18	0.21	0.819							
19	0.04	0.748							
20	0.01	0.706							
21	0.00	0.731	32.1	3.56					
22	0.00	0.747							
23	0.58	0.815							
24	0.0.1	0.787	31.4	6.1					
25	0.10	0.807							
26	0.01	0.790							
27	0.00	0.756							
28	0.00	0.773	34.4	4.41					
29	0.00	0.749							
30	0.00	0.786	33.1	3.82					
1	0.00	0.733							
2	0.00	0.730							
3	0.00	0.745							
TOTAL	1.00	23.293							
Average	0.03	0.78	32.49	5.47	0.017	17.00	0.006	6.10	#DIV/0!
MIN	0.00	0.71	28.90	3.56	0.017	17.00	0.006	6.10	0.00
MAX	0.58	0.86	37.20	8.12	0.017	17.00	0.006	6.10	0.00

ND = NON DETECTED

NA = NOT ANALYZED

ANALYTE	Units	METHOD USED	Daily Max	Avg. Monthly	Avg. Wkly	Inst. Max
TOTAL COPPER	ug/L	EPA 200.7	300			1500.000
TOTAL NICKEL	ug/L	EPA 200.7	600			
GREASE & OIL	mg/L	EPA 1664		25	40	75.0

CITY OF CRESCENT CITY WPCF - SUMMARY OF TREATMENT REPORT

DISCHARGE MONITORING - PERMIT No. CA0022756
ORDER # R1-2017-0002 ID # 1A84006ODN

Oct-20

ALL SAMPLES ARE FROM MONITORING LOCATION EFF-001 WITH EXCEPTION OF THE THREE IN BOLD MARKED INF

DAY	DAILY REQUIREMENTS						WEEKLY REQUIREMENTS																
	RAIN IN	INF FLOW MGD	FLOW MGD	pH	Temp.	TOTAL CL ₂ mg/L	Settleable Solids		SUSPENDED SOLIDS					BOD 5					FECAL MPN*	TURB NTU	TURB Wkly Avg		
							EFF	Wkly Avg(ml/L)	INF mg/L	EFF mg/L	Wkly Avg (mg/L)	LBS/DAY	Wkly Avg(lb/day)	INF mg/L	EFF mg/L	Wkly Avg(mg/L)	LBS/DAY	Wkly Avg(lb/day)					
27	0.00	0.965	0.756	7.19	21.80	<0.05	0.2		222	11	10.8	71	68.7	291	14.4	13.1	93	83.4	<1.8	4.6	3.6		
28	0.00	0.952	0.773	7.33	22.50	<0.05	0.1	0.171												2.8			
29	0.00	0.969	0.749	7.06	22.30	<0.05	0.3													4			
30	0.00	0.951	0.786	7.39	22.00	<0.05	0.2		270	11.2		73		318	12.8		84			3.3			
1	0.00	0.953	0.733	7.42	21.4	<0.05	<0.1		306	10.1		62		317	12.0		73				2.7		
2	0.00	0.949	0.730	7.37	21.1	<0.05	0.1														4.5		
3	0.00	0.956	0.745	7.46	21.1	<0.05	0.2												7.8		3.6		
4	0.000	0.943	0.746	7.33	20.9	<0.05	0.1														4.5		
5	0.000	0.931	0.701	7.34	20.6	<0.05	<0.1	0.114	250	10.5	10.8	61	65	313	11.8	12.2	69	73	33.0	2.4	3.6		
6	0.000	0.955	0.748	7.23	20.3	<0.05	0.1														4.9		
7	0.000	0.945	0.713	7.30	20.6	<0.05	<0.1		243	12.1		72		297	14.1		84		7.8	2.9			
8	0.000	0.968	0.752	7.35	20.7	<0.05	<0.1		349	9.9		62		342	10.6		66			2.9			
9	0.900	0.948	0.740	7.27	20.9	<0.05	0.1														3.2		
10	0.140	1.102	0.914	7.36	20.9	<0.05	0.2												11.0		4.7		
11	0.05	1.009	0.784	7.37	20.3	<0.05	<0.1														3.2		
12	0.08	0.994	0.803	7.33	21.1	<0.05	<0.1	0.114	292	8.0	8.2	54	53	296	8.2	9.9	55	64	17.0	3.1	3.6		
13	0.08	0.987	0.806	7.33	20.9	<0.05	0.1														4.3		
14	0.00	0.972	0.737	7.35	21.2	<0.05	<0.1		282	9.0		55		310	10.0		61		4.5	3.2			
15	0.00	0.983	0.773	7.44	20.9	<0.05	<0.1		230	7.7		50		302	11.6		75			3.7			
16	0.00	0.956	0.742	7.37	21.6	<0.05	0.2														4.3		
17	0.00	0.950	0.726	7.45	20.6	<0.05	0.1												49.0		3.5		
18	0.00	0.940	0.722	7.45	20.2	<0.05	0.2														4.2		
19	0.00	0.933	0.708	7.35	20.3	<0.05	<0.1	0.114	264	12.7	9.6	75	56	273	13.6	13.8	80	79	33.0	3.4	4.1		
20	0.00	0.952	0.742	7.40	19.9	<0.05	<0.1		428	7.9		49									3.6		
21	0.00	0.955	0.727	7.38	19.6	<0.05	<0.1												33.0		5.2		
22	0.00	0.960	0.730	7.41	19.6	<0.05	<0.1		317	9.4		57		319	15.3		93			3.9			
23	0.00	0.937	0.614	7.37	19.2	<0.05	<0.1		325.0	8.5		44		319	12.5		64			3			
24	0.00	0.938	0.734	7.41	20.0	<0.05	0.1												79.0		5.1		
25	0.00	0.932	0.703	7.37	18.9	<0.05	0.2														6.5		
26	0.00	0.943	0.746	7.28	19.1	<0.05	<0.1	0.157	384.0	12.9	13.3	80	82	281	12.8	13.2	80	82	<1.8	5.4	4.3		
27	0.00	0.940	0.730	7.17	19.2	<0.05	0.1												2.0		5		
28	0.00	0.950	0.841	7.33	19.2	<0.05	<0.1		346.0	14.2		100		315	14.2		100		33.0	3.3			
29	0.00	0.961	0.637	7.35	19.0	<0.05	<0.1		263.0	12.7		67		258	12.5		66		7.8	2.4			
30	0.00	0.932	0.755	7.30	19.1	<0.05	0.3												13.0		3.7		
31	0.00	0.913	0.745	7.25	18.6	<0.05	0.2												79.0		4		
TOTAL	1.25	29.69	23.03																				
AVG	0.0	1.0	0.7	7.4	20.2	<0.05	0.126	0.134	305.6	10.4	10.5	63.4	65.1	303.2	12.2	12.4	74.4	76.2	17.0	3.9	3.9		
MIN	0	0.913	0.614	7.17	18.6	<0.05	<0.1	0.114	230	7.7	8.2	43.5	52.8	258	8.2	9.9	54.9	63.7	<1.8	2.4	3.6		
MAX	0.90	1.10	0.91	7.46	21.60	<0.05	0.30	0.171	428.00	14.20	13.3	99.6	82.4	342.00	15.30	13.8	99.6	83.4	79.00	6.50	4.3		
DISCHARGE LIMITS:																							
INSTANT MAX.						1.8	3														225		
DAILY MAX.						0.24																	
7 DAY AVG.							1.5			45		700		45							100		
30 DAY AVG.							1			30		465		30						14	75		
DAILY MAX. OF 10%								1												43			
pH				6.0/9.0																			
SIX MONTH MEDIAN						0.06																	
TSS 85% REMOVAL																				BOD 85% REMOVAL			
TOTAL RAINFALL (year-to-date):						40.33		CALCULATED % REMOVALS					* see attached sheet for additional fecals										
								TSS 96.60					BOD 95.96		LOW VOLUME		same sample from 10/14/20, run by a different method						

CITY OF CRESCENT CITY WPCF - SUMMARY OF TREATMENT REPORT

DISCHARGE MONITORING - PERMIT No. CA0022756

ORDER # R1-2017-0002 ID # 1A84006ODN

Oct-20

ALL SAMPLES ARE FROM MONITORING LOCATION EFF-001 WITH EXCEPTION OF THE
THREE IN BOLD MARKED INF

DAY	RAIN IN	FLOW MGD	INF TOTAL AMMONIA mg/L	ONE SAMPLE PER MONTH REQUIRED					
				TOTAL AMMONIA mg/L	TOTAL COPPER mg/L	TOTAL COPPER ug/L	TOTAL NICKEL mg/L	TOTAL NICKEL ug/L	GREASE & OIL mg/L
27	0.00	0.756							
28	0.00	0.773	34.4	4.41					
29	0.00	0.749							
30	0.00	0.786	33.1	3.82					
1	0.00	0.733							
2	0.00	0.730							
3	0.00	0.745							
4	0.00	0.746							
5	0.00	0.701	30.8	7.00					
6	0.00	0.748							
7	0.00	0.713							
8	0.00	0.752	33.0	4.11					
9	0.90	0.740							
10	0.14	0.914							
11	0.05	0.784							
12	0.08	0.803	29.1	6.84					
13	0.08	0.806							
14	0.00	0.737			0.009	9.000	0.0079	7.900	<5.1
15	0.00	0.773	26.2	4.07	0.0097	9.7	0.005	5.000	
16	0.00	0.742							
17	0.00	0.726							
18	0.00	0.722							
19	0.00	0.708	29.80	7.80					
20	0.00	0.742							
21	0.00	0.727							
22	0.00	0.730	26.9	5.57					
23	0.00	0.614							
24	0.00	0.734							
25	0.00	0.703							
26	0.00	0.746	29.6	5.99					
27	0.00	0.730							
28	0.00	0.841							
29	0.00	0.637	27.3	6.60					
30	0.00	0.755							
31	0.00	0.745							
TOTAL									

AVG	0.0	0.7	29.1	6.0	0.0094	9.4	0.0065	6.5	<5.1
MIN	0	0.614	26.2	4.07	0.0090	9.0	0.0050	5.0	<5.1
MAX	0.90	0.91	33.00	7.80	0.0097	9.7	0.0079	7.9	<5.1

ND = NON DETECTED

NA = NOT ANALYZED

ANALYTE	Units	METHOD USED	Daily Max	Avg. Monthly	Avg. Wkly	Inst. Max
TOTAL COPPER	ug/L	EPA 200.7	300			1500.000
TOTAL NICKEL	ug/L	EPA 200.7	600			
GREASE & OIL	mg/L	EPA 1664		25	40	75.0

CITY OF CRESCENT CITY WPCF - SUMMARY OF TREATMENT REPORT

DISCHARGE MONITORING - PERMIT No. CA0022756

ORDER # R1-2017-0002 ID # 1A84006ODN

Nov-20

ALL SAMPLES ARE FROM MONITORING LOCATION EFF-001 WITH EXCEPTION OF THE THREE IN BOLD MARKED INF

DAY	DAILY REQUIREMENTS							WEEKLY REQUIREMENTS														
	RAIN IN	INF FLOW MGD	FLOW MGD	pH	Temp.	TOTAL CL ₂ mg/L	Settleable Solids		SUSPENDED SOLIDS					BOD 5					FECAL MPN	TURB NTU	TURB Wkly Avg	
							EFF	Wkly Avg(ml/L)	INF mg/L	EFF mg/L	Wkly Avg (mg/L)	LBS/DAY	Wkly Avg(lb/day)	INF mg/L	EFF mg/L	Wkly Avg(mg/L)	LBS/DAY	Wkly Avg(lb/day)				
1	0.00	0.907	0.685	7.22	19.10	<0.05	0.4														1.6	
2	0.00	0.905	0.686	7.24	18.60	<0.05	<0.1	0.143	332	10.1	10.5	58	61	279	10.3	10.9	59	63	7.8	1.5	2.4	
3	0.03	0.910	0.699	7.23	18.60	<0.05	0.1														4.2	
4	0.00	0.941	0.735	7.22	19.70	<0.05	<0.1		249	10.6		65		261	10.0		61				1.9	
5	0.45	0.947	0.670	7.30	19.30	<0.05	<0.1		262	10.9		61		268	12.5		70				1.7	
6	0.01	0.993	0.787	7.29	18.50	<0.05	<0.1												<1.8		4.2	
7	0.01	0.961	0.739	7.31	19.00	<0.05	<0.1												<1.8		1.6	
8	0.00	0.955	0.661	7.23	18.20	<0.05	<0.1														1.7	
9	0.00	0.961	0.627	7.25	17.80	<0.05	<0.1	0.100	348	7.4	8.0	39	41	336	7.0	8.1	37	42	<1.8	2.4	2.3	
10	0.02	0.942	0.614	7.31	18.40	<0.05	<0.1														2.2	
11	0.01	0.966	0.650	7.32	18.50	<0.05	<0.1		369										17.0		1.4	
12	0.64	0.949	0.613	7.38	18.40	<0.05	<0.1		393	8.5		43		307	9.2		47				1.8	
13	0.18	1.042	0.770	7.41	17.90	<0.05	<0.1														4.6	
14	1.20	1.001	0.691	7.35	18.10	<0.05	<0.1												2.0		2	
15	1.10	1.394	1.160	7.36	17.70	<0.05	<0.1														6.2	
16	0.51	1.109	0.857	7.22	18.20	<0.05	<0.1	0.114	283	15.4	11.7	110	90			10.1		81	7.8	5.1	4.6	
17	1.05	1.254	1.012	7.35	17.50	<0.05	<0.1														4.6	
18	0.04	1.309	1.052	7.39	17.60	<0.05	<0.1		356	10.9		96		305	10.4		91		4.5		5.2	
19	0.01	1.132	0.865	7.34	17.60	<0.05	<0.1		265	8.8		63		258	9.8		71				3.7	
20	0.00	1.100	0.834	7.35	17.30	<0.05	0.2														4	
21	0.00	1.074	0.776	7.34	17.60	<0.05	<0.1														3.4	
22	0.01	1.058	0.790	7.39	17.20	<0.05	<0.1														4.2	
23	0.01	1.054	0.723	7.30	17.50	<0.05	<0.1	0.100	381	10.6	9.0	64	56	297	12.2	10.4	74	64	17.0	3.2	3.6	
24	0.43	1.064	0.804	7.40	17.10	<0.05	<0.1														6.9	
25	0.04	1.090	0.835	7.31	17.30	<0.05	<0.1		149	8.8		61		342	9.9		69				3.2	
26	0.00	1.036	0.670	7.34	17.20	<0.05	<0.1		295	7.5		42		309	9.1		51				2.9	
27	0.00	1.018	0.738	7.34	17.00	<0.05	<0.1														2.2	
28	0.00	1.027	0.763	7.28	16.50	<0.05	<0.1														2.6	
29	0.00	1.005	0.753	7.29	17.50	<0.05	<0.1														2.5	
30	0.02	1.018	0.820	7.27	17.00	<0.05	<0.1	0.100	337	7.0	7.8	48	48	307	9.4	11.3	64	70	4.5	3.1	3.3	
1	0.01	1.006	0.757	7.30	16.90	<0.05	<0.1														3.1	
2	0.00	1.002	0.718	7.37	16.50	<0.05	<0.1		366	9.2		55		378	13.8		83				3	
3	0.00	0.997	0.699	7.44	17.20	<0.05	<0.1		368	7.1		41		346	10.7		62				2.4	
4	0.00	0.981	0.722	7.35	17.40	<0.05	<0.1														2.8	
5	0.62	1.059	0.796	7.45	17.30	<0.05	0.2														6	
TOTAL	5.77	31.12	23.08																			
(MEDIAN)																						
AVG	0.19	1.04	0.77	7.32	17.81	<0.05	0.113	0.111	309.15	9.71	9.38	62.50	59.17	297.18	9.98	10.17	63.03	64.07	4.5	3.2	3.2	
MIN	0.00	0.91	0.61	7.22	16.50	<0.05	<0.1	0.100	149.00	7.00	7.77	38.70	41.08	258.00	7.00	8.10	36.60	41.82	<1.8	1.4	2.3	
MAX	1.20	1.39	1.16	7.45	19.70	<0.05	0.400	0.143	393.00	15.40	11.70	110.07	89.73	342.00	12.50	11.30	91.25	80.97	17.00	6.90	4.6	
(MEDIAN)																						
DISCHARGE LIMITS:																						
INSTANT MAX.						1.8	3														225	
DAILY MAX.						0.24																
7 DAY AVG.							1.5			45		700		45							100	
30 DAY AVG.							1			30		465		30					14		75	
DAILY MAX. OF 10%								1											43			
pH				6.0/9.0																		
SIX MONTH MEDIAN						0.06																
										TSS 85% REMOVAL					BOD 85% REMOVAL							
TOTAL RAINFALL (year-to-date):						46.10					CALCULATED % REMOVALS					Low Volume						
											TSS 96.86					BOD 96.64					From weather forecast	

CITY OF CRESCENT CITY WPCF - SUMMARY OF TREATMENT REPORT

DISCHARGE MONITORING - PERMIT No. CA0022756

ORDER # R1-2017-0002 ID # 1A84006ODN

Nov-20

ALL SAMPLES ARE FROM MONITORING LOCATION EFF-001 WITH EXCEPTION OF THE
THREE IN BOLD MARKED INF

DAY	RAIN IN	FLOW MGD	INF TOTAL AMMONIA mg/L	ONE SAMPLE PER MONTH REQUIRED					GREASE & OIL mg/L
				TOTAL AMMONIA mg/L	TOTAL COPPER mg/L	TOTAL COPPER ug/L	TOTAL NICKEL mg/L	TOTAL NICKEL ug/L	
1	0.00	0.685							
2	0.00	0.686	29.3	2.8					
3	0.03	0.699							
4	0.00	0.735							
5	0.45	0.670	28.2	3.12	0.0150	15.000	0.0052	5.2	<5.0
6	0.01	0.787							
7	0.01	0.739							
8	0.00	0.661							
9	0.00	0.627	30.9	5.89					
10	0.02	0.614							
11	0.01	0.650							
12	0.64	0.613	31.2	6.91					
13	0.18	0.770							
14	1.20	0.691							
15	1.10	1.160							
16	0.51	0.857	21.6	6.2					
17	1.05	1.012							
18	0.04	1.052	22.2	6.58					
19	0.01	0.865							
20	0.00	0.834							
21	0.00	0.776							
22	0.01	0.790							
23	0.01	0.723	28.9	9.14					
24	0.43	0.804							
25	0.04	0.835							
26	0.00	0.670	26.7	5.16					
27	0.00	0.738							
28	0.00	0.763							
29	0.00	0.753							
30	0.02	0.820	29.5	8.48					
1	0.01	0.757							
2	0.00	0.718							
3	0.00	0.699							
4	0.00	0.722							
5	0.62	0.796							
TOTAL	5.77	23.08							

AVG	0.20	0.77	27.6	6.0	0.0150	15.0	0.0052	5.2	<5
MIN	0.00	0.61	21.6	2.8	0.0150	15.0	0.0052	5.2	<5
MAX	1.20	1.16	31.2	9.1	0.0150	15.0	0.0052	5.2	<5.0

ND = NON DETECTED

NA = NOT ANALYZED

ANALYTE	Units	METHOD USED	Daily Max	Avg. Monthly	Avg. Wkly	Inst. Max
TOTAL COPPER	ug/L	EPA 200.7	300			1500.000
TOTAL NICKEL	ug/L	EPA 200.7	600			
GREASE & OIL	mg/L	EPA 1664		25	40	75.0

CITY OF CRESCENT CITY WPCF - SUMMARY OF TREATMENT REPORT

DISCHARGE MONITORING - PERMIT No. CA0022756

ORDER # R1-2017-0002 ID # 1A84006ODN

Dec-20

ALL SAMPLES ARE FROM MONITORING LOCATION EFF-001 WITH EXCEPTION OF THE THREE IN BOLD MARKED INF

DAY	DAILY REQUIREMENTS						SETTLABLE SOLIDS						SUSPENDED SOLIDS						WEEKLY REQUIREMENTS				
	RAIN IN	INF FLOW MGD	FLOW MGD	pH	Temp.	TOTAL CL ₂ mg/L	Settleable Solids		INF		EFF		Wkly		BOD 5		FECAL MPN	TURB NTU	TURB Wkly Avg				
							EFF	Wkly Avg(ml/L)	mg/L	mg/L	mg/L	mg/L	LBS/DAY	LBS/DAY	LBS/DAY	LBS/DAY							
29	0.00	1.005	0.753	7.29	17.5	<0.05	<0.1												2.5				
30	0.02	1.018	0.820	7.27	17.0	<0.05	<0.1	337	7.0			48		307	9.4		64	4.5	3.1				
1	0.01	1.006	0.757	7.30	16.9	<0.05	<0.1	0.114				7.8		11.3			70	3.1	3.3				
2	0.00	1.002	0.718	7.37	16.5	<0.05	<0.1	366	9.2			55		378	13.8		83	4.5	3.0				
3	0.00	0.997	0.699	7.44	17.2	<0.05	<0.1	368	7.1			41		346	10.7		62	2.4					
4	0.00	0.981	0.722	7.35	17.4	<0.05	<0.1											2.8					
5	0.62	1.059	0.796	7.45	17.3	<0.05	0.2											4.5	6				
6	0.01	1.070	0.788	7.36	17.0	<0.05	0.1											3.6					
7	0.01	1.027	0.751	7.22	16.9	<0.05	<0.1	0.100	337	6.9	7.6	43	48	283	9.5	10.1	60	64	33.0	2.8	4.1		
8	0.07	1.026	0.728	7.34	17.2	<0.05	<0.1											4.4					
9	0.01	1.030	0.776	7.29	16.8	<0.05	<0.1	342	7.8			50		317	10.1		65		17.0	2.8			
10	0.18	1.039	0.752	7.34	16.8	<0.05	<0.1	341	8.2			51		328	10.6		66			3.2			
11	0.05	1.052	0.806	7.51	16.6	<0.05	<0.1													9			
12	0.87	1.035	0.754	7.30	16.7	<0.05	<0.1												4.5	3			
13	1.00	1.426	1.207	7.42	16.8	<0.05	0.2													5			
14	0.14	1.323	1.087	7.26	16.3	<0.05	<0.1	0.114	303	13.2	12.9	120	136	256	16.4	17.1	149	180	9.3	5.7	5.5		
15	0.18	1.270	1.028	7.35	15.8	<0.05	<0.1													5.3			
16	1.70	1.676	1.459	7.43	16.6	<0.05	<0.1	258	8.2			100		259	11.6		141		6.8	4.4			
17	0.01	1.543	1.294	7.36	16.1	<0.05	<0.1	259	17.4			188		217	23.3		251		5.4				
18	0.25	1.336	1.078	7.46	15.8	<0.05	<0.1													6.6			
19	0.26	1.302	1.065	7.46	16.4	<0.05	<0.1												4.5	6.4			
20	0.01	1.305	1.055	7.30	17.0	<0.05	<0.1													6.1			
21	0.79	1.394	1.141	7.31	16.6	<0.05	<0.1	0.100	294	9.3	9.9	88	89	265	11.9	13.5	113	120	4.5	4	6.7		
22	0.02	1.401	1.140	7.47	15.2	<0.05	<0.1													9.6			
23	0.00	1.290	1.028	7.39	15.4	<0.05	<0.1	236	11.3			97		230	14.6		125		5.5				
24	0.11	1.220	1.054	7.56	15.8	<0.05	<0.1	271	9.2			81		271	13.9		122		7.5				
25	1.23	1.452	1.194	7.46	16.2	<0.05	<0.1													6.8			
26	0.22	1.583	1.322	7.31	16.0	<0.05	<0.1													7.3			
27	0.01	1.442	1.165	7.45	15.6	<0.05	0.1													5.2			
28	0.00	1.371	1.085	7.41	15.7	<0.05	<0.1	0.100	267	10.1	9.5	91	88	227	12.7	12.7	115	118	4.5	5.6	5.1		
29	0.00	1.283	0.990	7.44	15.3	<0.05	<0.1													4.9			
30	1.09	1.383	1.112	7.43	16.2	<0.05	<0.1	264	8.7			81		266	11.8		109		4.1				
31	0.02	1.515	1.157	7.35	16.2	<0.05	<0.1	215	9.6			93		222	13.5		130		5.4				
1	0.65	1.513	1.383	7.33	16.1	<0.05	<0.1													4.8			
2	1.10	1.651	1.403	7.31	16.2	<0.05	<0.1													5.7			
TOTAL	8.87	38.839	30.708																(median)				
AVG	0.29	1.253	0.991	7.38	16.4	<0.05	0.106	0.106	294.4	9.7	9.5	84.3	81.8	276.1	13.2	12.9	113.8	110.5	4.5	5.06	4.94		
MIN	0.00	0.981	0.699	7.22	15.2	<0.05	<0.1	0.100	215.0	6.9	7.6	41.4	48.1	217.0	9.5	10.1	59.5	63.8	4.5	2.40	3.27		
MAX	1.70	1.676	1.459	7.56	17.4	<0.05	0.200	0.114	368.0	17.4	12.9	187.8	135.7	378.0	23.3	17.1	251.5	180.4	33.0	9.60	6.69		
DISCHARGE LIMITS:																							
INSTANT MAX.						1.8	3													225			
DAILY MAX.						0.24																	
7 DAY AVG.							1.5			45		700		45						100			
30 DAY AVG.							1			30		465		30						14	75		
DAILY MAX. OF 10%								1												43			
pH				6.0/9.0																			
SIX MONTH MEDIAN						0.06																	
										TSS 85% REMOVAL				BOD 85% REMOVAL									
TOTAL RAINFALL (year-to-date):						54.97						CALCULATED % REMOVALS				Rain fall data from ranney tower Low Volume							
								TSS 96.69				BOD 95.23											

CITY OF CRESCENT CITY WPCF - SUMMARY OF TREATMENT REPORT

DISCHARGE MONITORING - PERMIT No. CA0022756

ORDER # R1-2017-0002 ID # 1A84006ODN

Dec-20

ALL SAMPLES ARE FROM MONITORING LOCATION EFF-001 WITH EXCEPTION OF THE
THREE IN BOLD MARKED INF

DAY	RAIN IN	FLOW MGD	INF TOTAL AMMONIA mg/L	ONE SAMPLE PER MONTH REQUIRED					GREASE & OIL mg/L
				TOTAL AMMONIA mg/L	TOTAL COPPER mg/L	TOTAL COPPER ug/L	TOTAL NICKEL mg/L	TOTAL NICKEL ug/L	
29	0.00	0.753							
30	0.02	0.820	29.5	8.48					
1	0.01	0.757							
2	0.00	0.718							
3	0.00	0.699	28.6	4.81	0.011	11.0	0.0073	7.3	<6.3
4	0.00	0.722							
5	0.62	0.796							
6	0.01	0.788							
7	0.01	0.751	25.8	5.31					
8	0.07	0.728							
9	0.01	0.776							
10	0.18	0.752	28.0	9.6					
11	0.05	0.806							
12	0.87	0.754							
13	1.00	1.207							
14	0.14	1.087	21.5	7.01					
15	0.18	1.028							
16	1.70	1.459	23.0	6.03					
17	0.01	1.294							
18	0.25	1.078							
19	0.26	1.065							
20	0.01	1.055							
21	0.79	1.141	22.0	6.83					
22	0.02	1.140							
23	0.00	1.028							
24	0.11	1.054	23.9	9.08					
25	1.23	1.194							
26	0.22	1.322							
27	0.01	1.165							
28	0.00	1.085	20.5	10.2					
29	0.00	0.990							
30	1.09	1.112							
31	0.02	1.157	21.0	8.63					
1	0.65	1.383							
2	1.10	1.403							
TOTAL	8.87	30.708							
AVG	0.29	0.991	23.8	7.50	0.011	11.0	0.0073	7.3	<6.3
MIN	0.00	0.699	20.5	4.81	0.011	11.0	0.0073	7.3	<6.3
MAX	1.70	1.459	28.6	10.20	0.011	11.0	0.0073	7.3	<6.3
ND = NON DETECTED			NA = NOT ANALYZED						
ANALYTE	Units	METHOD USED	Daily Max	Avg. Monthly	Avg. Wkly	Inst. Max			
TOTAL COPPER	ug/L	EPA 200.7	300			1500.000			
TOTAL NICKEL	ug/L	EPA 200.7	600						
GREASE & OIL	mg/L	EPA 1664		25	40	75.0			

CITY OF CRESCENT CITY WPCF - SUMMARY OF TREATMENT REPORT

DISCHARGE MONITORING - PERMIT No. CA0022756

ORDER # R1-2017-0002 ID # 1A84006ODN

Jan-21

ALL SAMPLES ARE FROM MONITORING LOCATION EFF-001 WITH EXCEPTION OF THE
THREE IN BOLD MARKED INF

DAY	RAIN IN	FLOW MGD	INF TOTAL AMMONIA mg/L	ONE SAMPLE PER MONTH REQUIRED					
				TOTAL AMMONIA mg/L	TOTAL COPPER mg/L	TOTAL COPPER ug/L	TOTAL NICKEL mg/L	TOTAL NICKEL ug/L	GREASE & OIL mg/L
27	0.01	1.165							
28	0	1.085	20.5	10.2					
29	0	0.99							
30	1.09	1.112							
31	0.02	1.157	21	8.63					
1	0.65	1.383							
2	1.10	1.403							
3	0.61	1.736							
4	0.800	1.732	15.2						
5	0.530	1.560							
6	0.390	1.671	16.9	11.6	0.0077	7.7	0.0054	5.4	<5.1
7	0.600	1.429	14.6	9.3					
8	0.000	1.693							
9	0.880	1.429							
10	0.010	1.788							
11	0.99	1.519							
12	1.27	3.863							
13	0.02	3.783	6.7	6.13					
14	0.00	2.562	7.8	3.91					
15	0.01	2.153							
16	0.01	1.919							
17	0.00	1.744							
18	0.00	1.639	15.3	8.74					
19	0.00	1.563							
20	0.00	1.452							
21	0.14	1.341	16.2	9.38					
22	0.05	1.338							
23	0.12	1.309							
24	0.25	1.387							
25	0.01	1.341	17.3	11.0					
26	1.00	1.395							
27	1.16	2.241							
28	0.12	2.901	est 11.8	est 6.91					
29	0.14	2.177							
30	1.25	2.102							
31	1.14	3.100							
TOTAL	13.25	58.65							

AVG	0.43	1.89	13.5	8.4	0.008	7.7	0.005	5.4	<5.1
MIN	0.00	1.31	6.7	3.9	0.008	7.7	0.005	5.4	<5.1
MAX	1.27	3.86	17.3	11.6	0.008	7.7	0.005	5.4	<5.1

ND = NON DETECTED

NA = NOT ANALYZED

ANALYTE	Units	METHOD USED	Daily Max	Avg. Monthly	Avg. Wkly	Inst. Max
TOTAL COPPER	ug/L	EPA 200.7	300			1500.000
TOTAL NICKEL	ug/L	EPA 200.7	600			
GREASE & OIL	mg/L	EPA 1664		25	40	75.0

CITY OF CRESCENT CITY WPCF - SUMMARY OF TREATMENT REPORT

DISCHARGE MONITORING - PERMIT No. CA0022756

ORDER # R1-2017-0002 ID # 1A84006ODN

Feb-21

ALL SAMPLES ARE FROM MONITORING LOCATION EFF-001 WITH EXCEPTION OF THE THREE IN BOLD MARKED INF

DAY	DAILY REQUIREMENTS						WEEKLY REQUIREMENTS																		
	RAIN IN	INF FLOW MGD	FLOW MGD	pH	Temp.	TOTAL CL ₂ mg/L	Settleable Solids		SUSPENDED SOLIDS					BOD 5				FECAL MPN	TURB NTU	TURB Wkly Avg					
							EFF	Wkly Avg(mg/L)	INF mg/L	EFF mg/L	Wkly Avg (mg/L)	LBS/DAY	Wkly Avg(lb/day)	INF mg/L	EFF mg/L	Wkly Avg(mg/L)	LBS/DAY				Wkly Avg(lb/day)				
31	1.14	4.462	3.1			<0.05	0.1													6					
1	1.05	5.193	5.270	7.17	13.9	<0.05	0.1	0.010	94	16.0	13.2	703							13.6			13.0	8.2	6.3	
2	0.54	3.513	3.737	7.22	14.1	<0.05	<0.1						426										7.7		
3	0.05	3.152	3.283	7.30	13.6	<0.05	<0.1		128	10.7		293										79.0	7.1		
4	0.020	2.695	2.603	7.32	13.9	<0.05	<0.1		92	13.0		282											4.7		
5	0.020	2.452	2.197	7.42	14.5	<0.05	<0.1																5.2		
6	0.000	2.306	2.002	7.44	14.5	<0.05	0.1															<1.8	4.9		
7	0.000	2.168	1.856	7.45	14.7	<0.05	0.5																5.5		
8	0.000	2.044	1.675	7.46	13.9	<0.05	<0.1	0.186	243	11.4	9.7	159										7.8	4.6	6.0	
9	0.000	1.939	1.608	7.35	14.6	<0.05	0.1						133										4.4		
10	0.000	1.863	1.527	7.46	14.5	<0.05	<0.1		251	9.6		122										2.0	7.4		
11	0.84	2.139	1.768	7.32	15.2	<0.05	<0.1		204	8.0		118											5.4		
12	2.35	2.877	2.092	7.40	15.1	<0.05	0.2																5.1		
13	0.50	3.067	3.149	7.18	14.3	<0.05	0.2															2.0	9.6		
14	1.06	3.334	2.791	7.36	14.3	<0.05	<0.1																5		
15	0.35	3.382	3.533	7.26	14.2	<0.05	<0.1	0.186	109	10.4	8.4	306										<1.8	4.8	4.9	
16	0.02	2.889	2.857	7.29	14.3	<0.05	<0.1						205										4.7		
17	0.10	2.269	2.373	7.34	13.8	<0.05	<0.1		89.4	7.4		146										4.5	4		
18	1.00	3.016	2.643	7.39	14.9	<0.05	<0.1		114	7.3		161											5.6		
19	0.78	3.244	2.982	7.30	14.4	<0.05	0.3																5		
20	0.02	2.812	2.771	7.33	13.8	<0.05	0.5															11.0	5.2		
21	0.00	2.554	2.375	7.28	14.7	<0.05	<0.1																5.4		
22	0.02	2.466	2.209	7.25	14.8	<0.05	<0.1	0.114	163	8.1	7.9	149										2.0	4.4	5.2	
23	0.00	2.282	2.001	7.34	14.7	<0.05	<0.1						128										5.7		
24	0.00	2.127	1.849	7.44	14.8	<0.05	<0.1		178.0	7.9		122											5.1		
25	0.04	2.029	1.746	7.38	14.7	<0.05	<0.1		161.0	7.8		114											4.8		
26	0.05	1.955	1.677	7.44	14.6	<0.05	0.2																5.9		
27	0.01	1.889	1.594	7.53	16.0	<0.05	0.1																5.1		
28	0.01	1.843	1.634	7.34	15.1	<0.05	<0.1																5.9		
TOTAL	8.83	73.50	67.80																						
								Low volume			estimated value				value from water run										
(MEDIAN)																									
AVG	0.32	2.62	2.42	7.35	14.50	<0.05	0.146	0.124	152	9.80	9.80	223	223	150	12.49	12.58	241	248	3.3	5.59	5.59				
MIN	0.00	1.84	1.53	7.17	13.60	<0.05	<0.01	0.010	89	7.30	7.93	114	128	103	10.80	11.57	157	173	<1.8	4.00	4.90				
MAX	2.35	5.19	5.27	7.53	16.00	<0.05	0.50	0.186	251	16.00	13.23	703	426	210	15.10	13.60	407	330	79.00	9.60	6.26				
DISCHARGE LIMITS:																									
INSTANT MAX.						1.8	3															225			
DAILY MAX.						0.24																			
7 DAY AVG.							1.5			45		700			45							100			
30 DAY AVG.							1			30		465			30						14	75			
DAILY MAX. OF 10%								1													43				
pH				6.0/9.0																					
SIX MONTH MEDIAN						0.06																			
												TSS 85% REMOVAL						BOD 75% REMOVAL							
TOTAL RAINFALL (year-to-date):						22.08																			
												CALCULATED % REMOVALS													
												TSS 93.56						BOD 91.65							

CITY OF CRESCENT CITY WPCF - SUMMARY OF TREATMENT REPORT

DISCHARGE MONITORING - PERMIT No. CA0022756

ORDER # R1-2017-0002 ID # 1A84006ODN

Feb-21

ALL SAMPLES ARE FROM MONITORING LOCATION EFF-001 WITH EXCEPTION OF THE
THREE IN BOLD MARKED INF

DAY	RAIN IN	FLOW MGD	INF TOTAL AMMONIA mg/L	ONE SAMPLE PER MONTH REQUIRED					
				TOTAL AMMONIA mg/L	TOTAL COPPER mg/L	TOTAL COPPER ug/L	TOTAL NICKEL mg/L	TOTAL NICKEL ug/L	GREASE & OIL mg/L
31	1.14	3.1							
1	1.05	5.270	7.3	5.52					
2	0.54	3.737							
3	0.05	3.283			0.006	5.7	0.010	10	<4.7
4	0.02	2.603	8.1	6.8					
5	0.02	2.197							
6	0.00	2.002							
7	0.00	1.856							
8	0.00	1.675	12.4	12.7					
9	0.00	1.608							
10	0.00	1.527							
11	0.84	1.768	15.4	9.05					
12	2.35	2.092							
13	0.50	3.149							
14	1.06	2.791							
15	0.35	3.533	9.7	5.8					
16	0.02	2.857							
17	0.10	2.373							
18	1.00	2.643	10.4	5.92					
19	0.78	2.982							
20	0.02	2.771							
21	0.00	2.375							
22	0.02	2.209	11.0	6.5					
23	0.00	2.001							
24	0.00	1.849							
25	0.04	1.746	13.3	9.8					
26	0.05	1.677							
27	0.01	1.594							
28	0.01	1.634							
TOTAL	8.83	67.80							

AVG	0.32	2.42	10.95	7.76	0.006	5.7	0.010	10.0	<4.7
MIN	0.00	1.53	7.28	5.52	0.006	5.7	0.010	10.0	<4.7
MAX	2.35	5.27	15.40	12.70	0.006	5.7	0.010	10.0	<4.7

ND = NON DETECTED

NA = NOT ANALYZED

ANALYTE	Units	METHOD USED	Daily Max	Avg. Monthly	Avg. Wkly	Inst. Max
TOTAL COPPER	ug/L	EPA 200.7	300			1500.000
TOTAL NICKEL	ug/L	EPA 200.7	600			
GREASE & OIL	mg/L	EPA 1664		25	40	75.0

Appendix B:

**Annual Reports
2017-2020**

Crescent City 2017 Annual Report
ORDER NO. R1-2017-0002
NPDES NO. CA0022756
WDID NO. 1A84006ODN

Item 1- Where appropriate, tabular and/or graphical summaries of the monitoring data and disposal records from the previous year. If the Permittee monitors any pollutant more frequently than required by this Order, using test procedures approved under 40 C.F.R. part 136 or as specified in this Order, the results of this monitoring shall be included in the calculation and report of the data submitted SMR.

Included as Attachment 1

Item 2. A comprehensive discussion of the Facility's compliance (or lack thereof) with all effluent limitations and other WDRs, and the corrective actions taken or planned, which may be needed to bring the discharge into full compliance with the Order.

<p>Summary of Facility Performance</p>

<p>We have one violation to report in 2017 which occurred in the month of November. We had a single Fecal Coliform value with an MPN of 920 on November 15, 2017. This result exceeded our daily maximum but we still met our monthly median requirement. The cause was determined to be from a power failure a few hours prior to taking the sample. Had we waited a little while longer for the chlorine residual to return to normal, this would not have been an issue. Because the sample was taken so soon after a power failure, it was not a representative sample as required for purposes of monitoring [40 CFR 122.41 (j)(1).</p>
--

<p>In compiling the Ocean Plan Test results, we determined that the Contract Lab provided no report for hexachlorobutadiene. We have contacted the Lab to determine if the test was performed and will submit if results are available.</p>

Overall, the plant performed quite well during the year as we met the discharge requirements of our NPDES Permit.

Item 3. The names and general responsibilities of all persons employed at the Facility;

See attached matrix and directory of WWTP Personnel-

<u>Grade</u>	Name	Title	Responsibilities
Grade V	Tom Romesberg	Utility Manager/CPO	Supervisor
Grade IV	Jesse Wood	Senior Operator	Training
Grade II	Elizabeth Martinez	Operator	Operations
Grade II	Michael Petersen	Operator	Operations
Grade I-OIT	Austin Nova	Operator	Operations
Grade I-OIT	Trevor McCaffrey	Operator	Operations

Item 4 The names and telephone numbers of persons to contact regarding the Facility for emergency and routine situations;

Tom Romesberg (707) 465-3129
Eric Wier (707) 464-9759

Item 5. A statement certifying when the flow meter(s) and other monitoring instruments and devices were last calibrated, including identification of who performed the calibration.

No calibration activity on Influent Parshall Flume in 2017. Calibration and adjustment performed on effluent meter in 2017 by City Electrical Operational Maintenance Technicians

Item 6 - Sludge Handling and Disposal Activity Reporting. The Permittee shall submit, as part of its annual report to the Regional Water Board, a description of the Permittee's solids handling, disposal and reuse activities over the previous 12 months. At a minimum, the report shall contain:

- i. Annual sludge production, in dry tons and percent solids;

191.6 dry metric tons. Monthly production included in Attachment 1 Graphs.

- ii. Sludge monitoring results;

Results are included as Attachment 2

- iii. A schematic diagram showing sludge handling facilities (e.g., digesters, thickeners, drying beds, etc.), if any and a solids flow diagram;

See Plant Diagram included as Attachment 3

- iii. Methods of final disposal of sludge:

Disposal at White City Oregon Landfill, a Munciple Landfill Under 40 CFR 258

Item g. Storm Water Reporting.

The City of Crescent City is MS4 Exempt.

Item h. Septage Monitoring and Reporting. The results of septage monitoring shall be provided as follows: i. A narrative description of all preparatory, monitoring, sampling, and analytical testing activities for the septage monitoring program. The narrative shall be sufficiently detailed to verify compliance with waste discharge requirements and this MRP.

Currently not approved for septage. A Prop 1 grant request to install a septage receiving facility has been submitted to the State Water Resources Control Board.

Item i. DMR-QA Study Report. . The Permittee shall submit, as part of its annual report to the Regional Water Board, an electronic copy of the annual DMR-QA study report submitted to the State Water Board, Quality Assurance Program Officer pursuant to section I.F of this MRP.

Included as Attachment 4

Annual Pretreatment Reporting Requirements. The Permittee shall submit annually

Included as Attachment 5

Russ Burnette

From: ciwqshelp@waterboards.ca.gov
Sent: Monday, February 26, 2018 9:22 AM
To: Tom Romesberg
Cc: CGoodwin@waterboards.ca.gov; Tom Romesberg; Jesse Wood; Russ Burnette
Subject: CIWQS Confirmation - Report(s) Submitted for Order R1-2017-0002

CAUTION: This email originated from outside of the organization. Do not click links or open attachments unless you recognize the sender and know the content is safe.

This e-mail is to confirm receipt of the following reports in accordance with the requirements of Order R1-2017-0002. These reports were submitted for Crescent City WWTP on 02/26/2018 by Thomas Jay Romesberg:

- Annual SMR (MONRPT) report for 2017 (due 03/01/2018)
- DMR - 001-S for 07/01/2017 - 12/31/2017 (due 03/01/2018)

Violation ID	Violation Date	Violation Type	Description	Corrective Action
No self-determined violations were entered for this report.				

Click the following link to access the submitted report:

<https://ciwqs.waterboards.ca.gov/ciwqs/RedirectServlet?regMeasID=404228&facID=216106&docID=1932444&module=esmrReport>

Click the following link to access the copy of record:

https://ciwqs.waterboards.ca.gov/ciwqs/RedirectServlet?regMeasID=404228&facID=216106&docID=1932444&module=reportZip&zipName=eSMR_404228_216106_20180226-092102-1932444_2017.zip

The hash value of the copy of the record is as follows:

5657c4dd879d16d8a1b2547a5abca39ff63ae96adfc741f9a1ac177db67e0

If you need to contact your local Water Board, your case manager is Cathleen A. Goodwin (707-576-2687 or CGoodwin@waterboards.ca.gov).

Email auto-generated by CIWQS on 02/26/2018



377 J STREET

CRESCENT CITY, CALIFORNIA 95531-4025

Administration / Finance (707) 464-7483
Utilities (707) 464-6517
WPCF (707) 464-5416

Public Works / Planning (707) 464-9506
Fax (707) 464-4405
Construction (707) 464-6319

February 26, 2018

Regional Water Quality Control Board
Northcoast Region
5550 Skylane Boulevard Suite A
Santa Rosa, CA 95403

Attention: Cathy Goodwin

RE: NPDES CA0022756 - WDID 1A84006ODN

Dear Ms. Goodwin

Enclosed, please find the 2017 ANNUAL REPORT for the City of Crescent City Water Pollution Control Facility, located at 210 Battery Street, WDID Number 1A84006ODN, required under NPDES Permit Number CA0022756.

We have one violation to report in 2017 which occurred in the month of November. We had a single Fecal Coliform value with an MPN of 920 on November 15, 2017. This result exceeded our daily maximum but we still met our monthly median requirement. The cause was determined to be from a power failure a few hours prior to taking the sample. Had we waited a little while longer for the chlorine residual to return to normal, this would not have been an issue. Because the sample was taken so soon after a power failure, it was not a representative sample as required for purposes of monitoring [40 CFR 122.41 (j)(1)].

In compiling the Ocean Plan Test results, we determined that the Contract Lab provided no report for hexachlorobutadiene. We have contacted the Lab to determine if the test was performed and will submit if results are available.

Overall, the plant performed quite well during the year as we met the discharge requirements of our NPDES Permit.

I certify under penalty of law that this document and all attachments were prepared under my direction or supervision in accordance with a system designed to assure that qualified personnel properly gather and evaluate the information submitted. Based on my inquiry of the person or persons who manage the system, or those persons directly responsible for gathering the information, the information submitted is, to the best of my knowledge and belief, true, accurate, and complete. I am aware that there are significant penalties for submitting false information, including the possibility of fine and imprisonment for knowing violations." [40 CFR §122.22(d)]

If you have any questions about this annual report, please contact me at (707) 465-3129.

Regards,



Tom Romesberg
Utility Manager/ CPO
City of Crescent City
Water Pollution Control Facility

Attachment: 1 - 2017 Graphical summary of results

Attachment 2 - Annual Priority Pollutants North Coast Laboratory 103017

Attachment 3 - California Laboratory Services Submittal 022318

Attachment 4 – Pretreatment Report

2017 EFFLUENT S/S & BOD

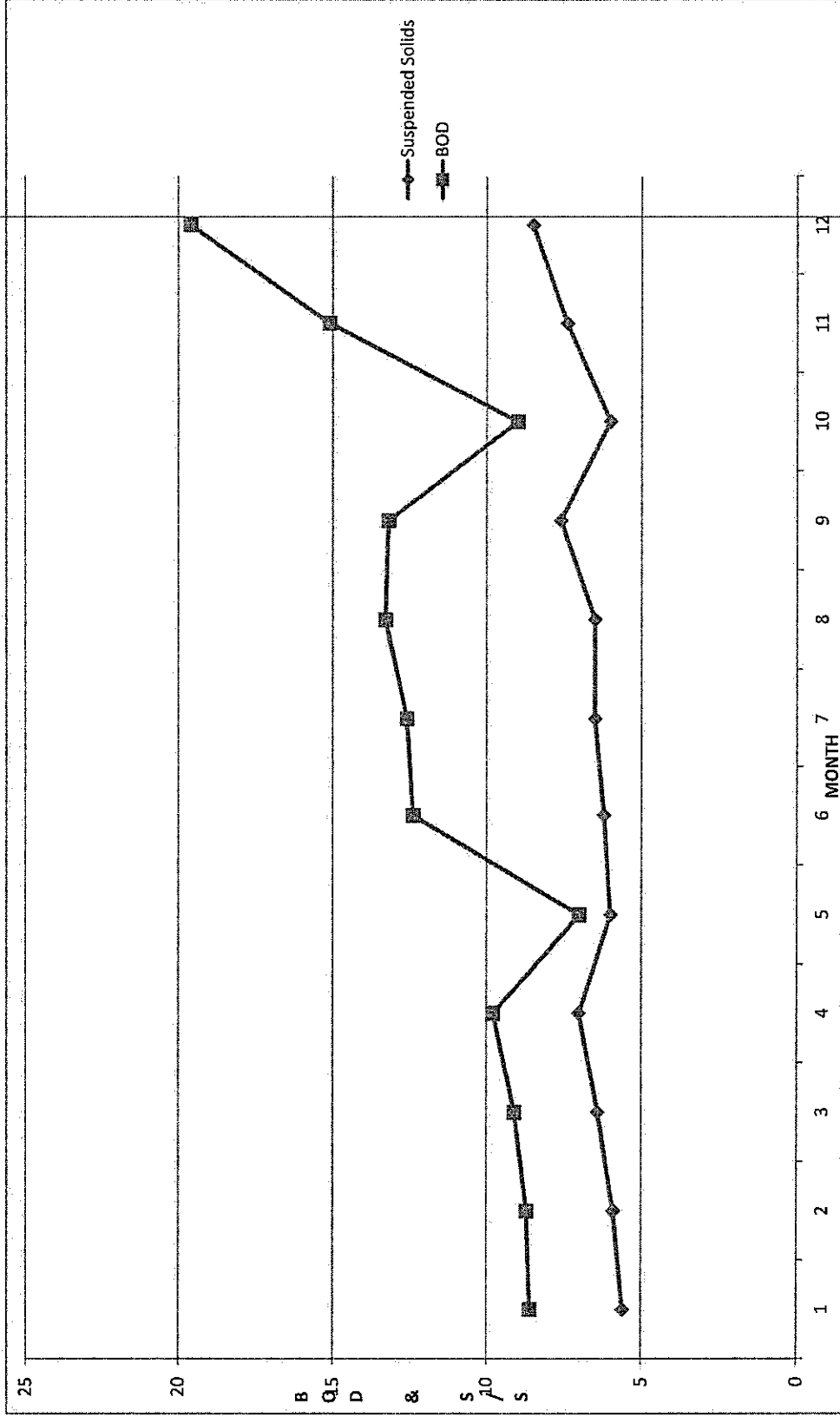

LIMIT 30 mg/L
 SUSPENDED SOLIDS YEARLY AVERAGE 6.6 mg/L
 BOD YEARLY AVERAGE 11.5 mg/L

	JAN	FEB	MAR	APR	MAY	JUN	JUL	AUG	SEP	OCT	NOV	DEC
S.S.	5.6	5.9	6.4	7.0	6.0	6.2	6.5	6.5	7.6	6.0	7.4	8.5
BOD	8.6	8.7	9.1	9.8	7	12.4	12.6	13.3	13.2	9.0	15.1	19.6
FLOW	3,070	3,418	2,971	2,754	1,813	1,417	1,041	1,029	0,880	0,868	1,222	1,348
LBS/Day	220.2	248.0	225.5	225.1	105.8	146.5	109.4	114.1	96.9	65.2	153.9	220.3

CITY OF CRESCENT CITY - SUMMARY OF TREATMENT
DISCHARGE MONITORING - NPDES PERMIT NO.CA0022756
2017 ANNUAL REPORT

MONTH	FLOW MGD TOTAL	CALCULATED		VIOLATIONS					
		TSS% REMOVAL	BOD% REMOVAL	PARAMETER	MONTH	DAILY	# OF TESTS RUN	% MONTHLY VIOL	% DAILY VIOL
JAN	95.17	94.3	91.0		0	0	365	0	0
FEB	95.71	93.3	89.7		0	0	365	0	0
MAR	92.10	93.6	90.3		0	0	365	0	0
APR	82.63	94.2	90.9		0	0	155	0	0
MAY	56.20	96.8	96.0		0	0	155	0	0
JUN	42.50	97.1	94.7		0	0	153	0	0
JUL	32.27	97.4	95.9		0	0	153	0	0
AUG	31.90	97.6	95.7		0	0	140	0	9
SEP	26.41	97.1	95.5		0	0	12	0	0
OCT	26.91	97.9	97.0		0	0	365	0	0
NOV	36.65	96.3	93.2		0	0		0	0
DEC	35.95	95.5	90.9		0	0		0	0
TOTAL	654.40				0	1			
AVG	54.53	95.9	93.4	TOTAL VIOL	0	1			
MIN	26.41	93.3	89.7						
MAX	95.71	97.9	97.0						

WWTP BOD/TSS % REDUCTION For 2017

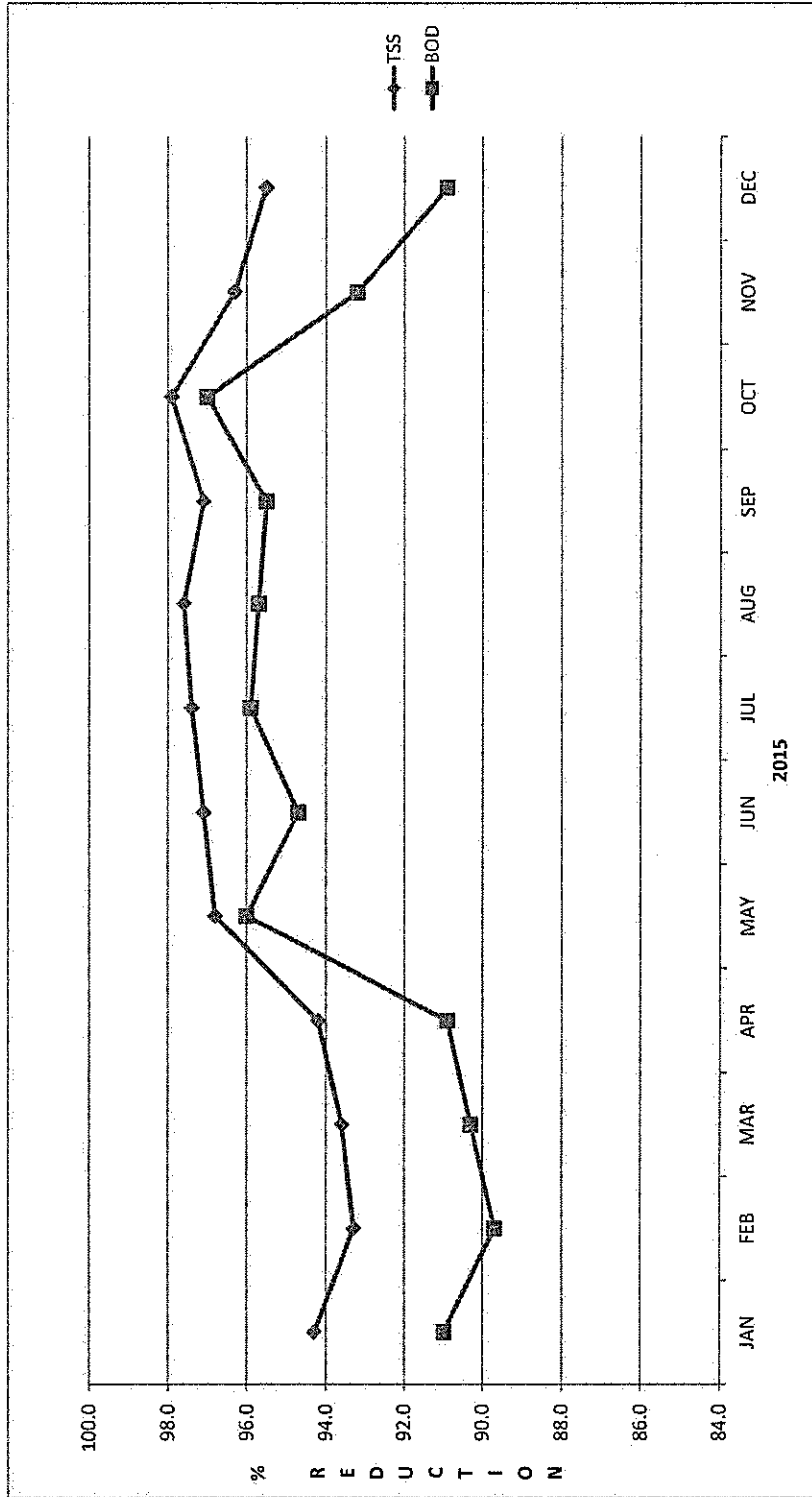

SUSPENDED SOLIDS YEARLY AVERAGE 95.9%

BOD YEARLY AVERAGE 93.4%

	JAN	FEB	MAR	APR	MAY	JUN	JUL	AUG	SEP	OCT	NOV	DEC
TSS	94.3	93.3	93.6	94.2	96.8	97.1	97.4	97.6	97.1	97.9	96.3	95.5
BOD	91.0	89.7	90.3	90.9	96.0	94.7	95.9	95.7	95.5	97.0	93.2	90.9

2017 FLOW & RAINFALL

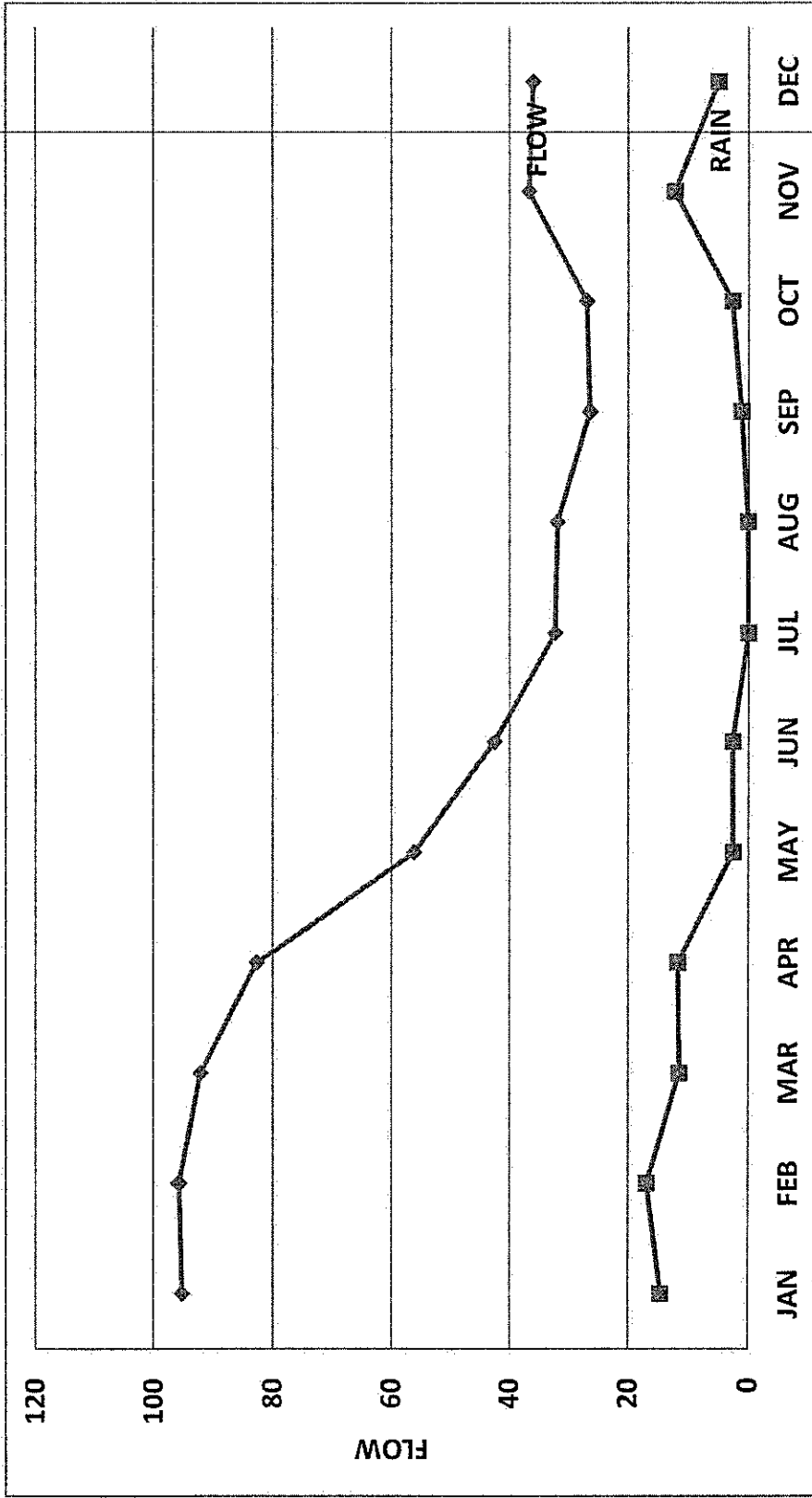

FLOW TOTAL 654.4 MILLION GALLONS
 MONTHLY AVERAGE 54.5 MILLION GALLONS

RAINFALL ANNUAL TOTAL 81.26 INCHES
 MONTHLY AVERAGE 6.77 INCHES

	JAN	FEB	MAR	APR	MAY	JUN	JUL	AUG	SEP	OCT	NOV	DEC
FLOW	95.17	95.71	92.09	82.63	56.2	42.5	32.27	31.9	26.41	26.91	36.65	36.95
RAINFALL	14.63	16.93	11.52	11.73	2.56	2.64	0.01	0.09	1.17	2.73	12.28	4.97

2017 FECAL COLIFORM

Median Fecal Coliform

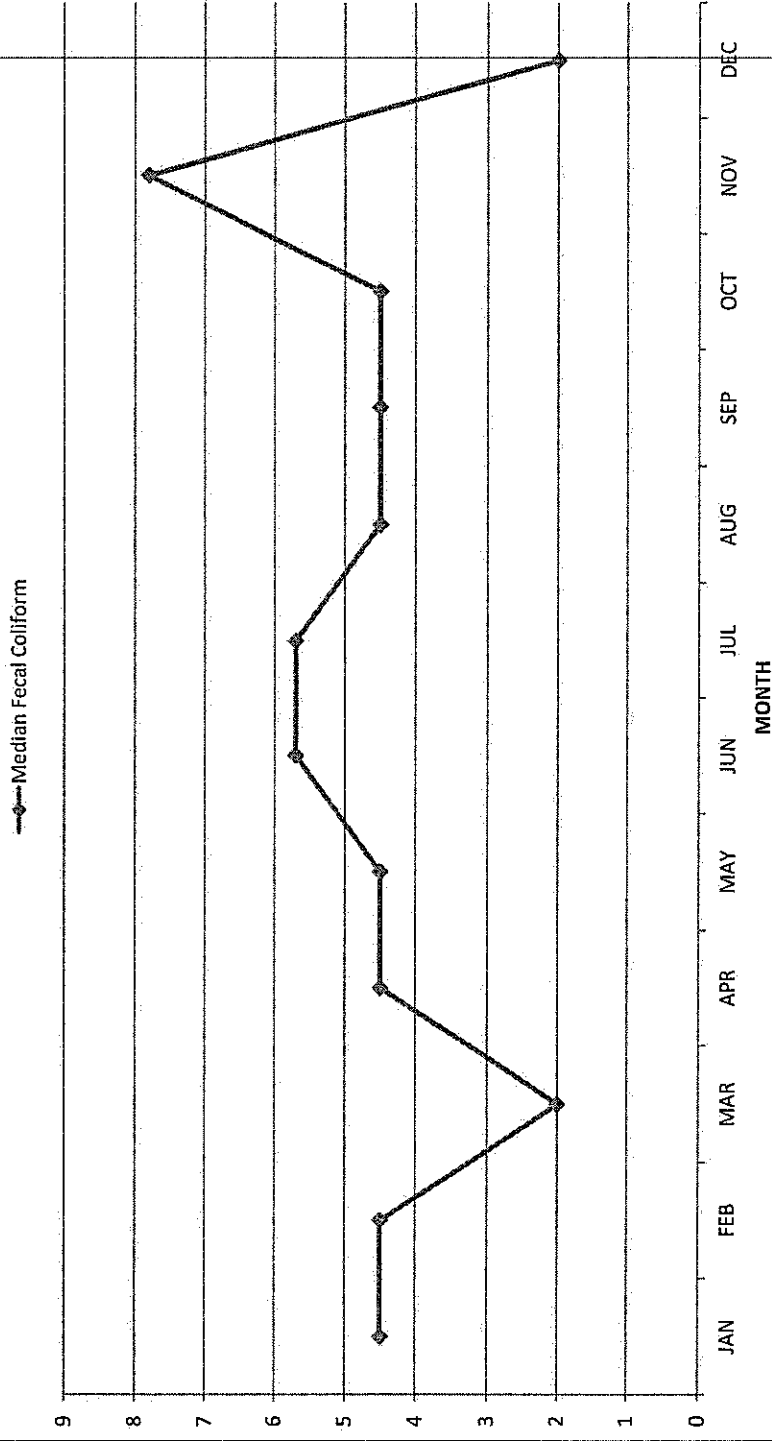

LIMIT 14 MPN MONTHLY MEDIAN

MEDIAN YEARLY AVERAGE = 4.6
 MONTHS IN VIOLATION = 0
 DAYS IN VIOLATION = 1
 MONTHS IN VIOLATION = 0%
 DAYS VIOLATION 0.7% (1 OUT OF 140 TESTS)

FECAL COLIFORM	JAN	FEB	MAR	APR	MAY	JUN	JUL	AUG	SEP	OCT	NOV	DEC
	4.5	2	2	2	2	4.5	4	2	4.5	4.5	7.8	2

2017 GREASE & OIL, TURBIDITY

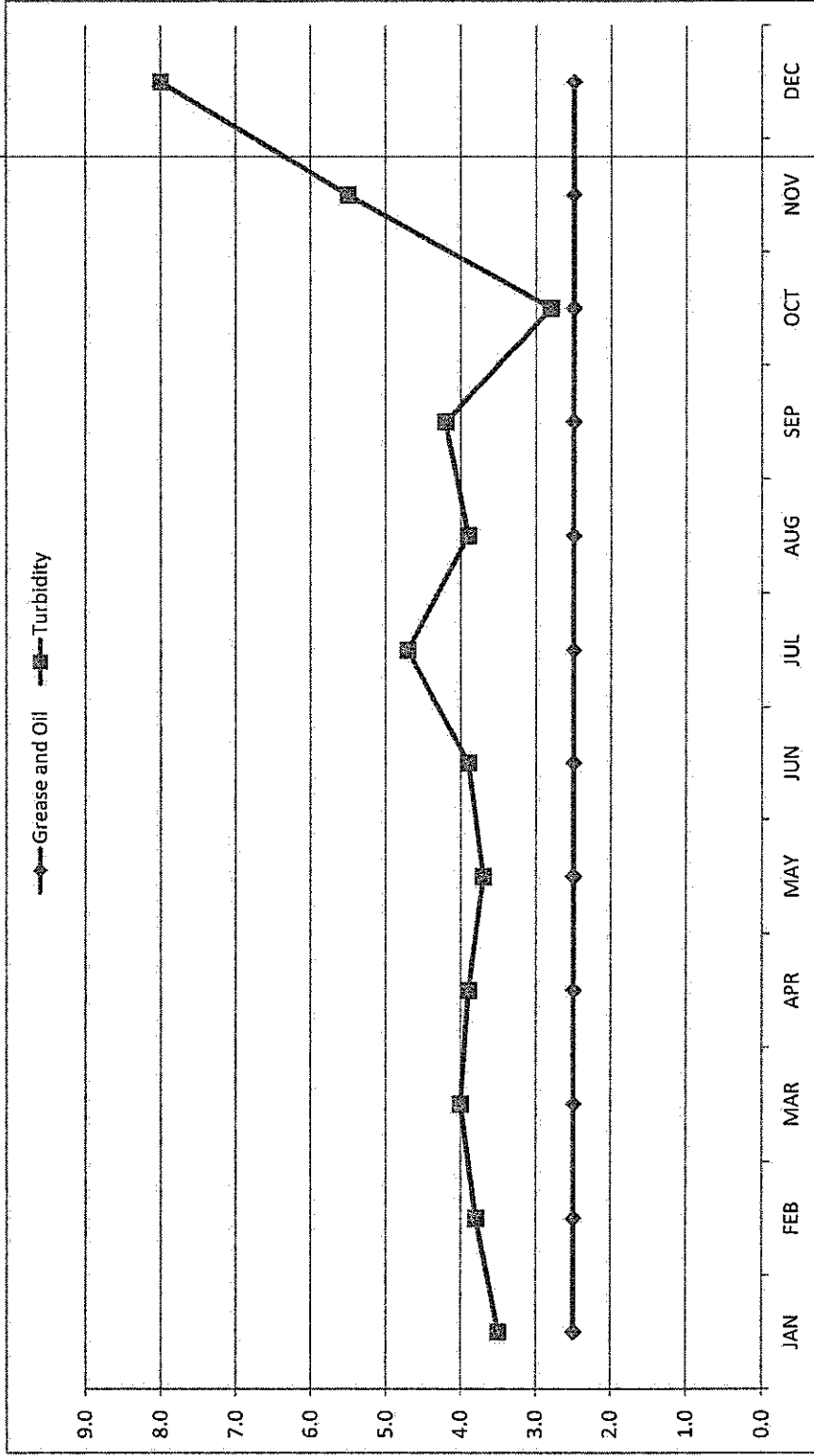

LIMITS: GREASE & OIL - 25mg/L, TURBIDITY - 75 NTU

GREASE & OIL YEARLY AVERAGE <5.0mg/L
TURBIDITY YEARLY AVERAGE ___ NTU

GREASE & OIL	JAN	FEB	MAR	APR	MAY	JUN	JUL	AUG	SEP	OCT	NOV	DEC
TURBIDITY	<5	<5	<5	<5	<5	<5	<5	<5	<5	<5	<5	<5
	3.5	3.8	4.0	3.9	3.7	3.9	4.7	3.9	4.2	2.8	5.5	8.0

2017 INFLUENT SUSPENDED SOLIDS & BOD

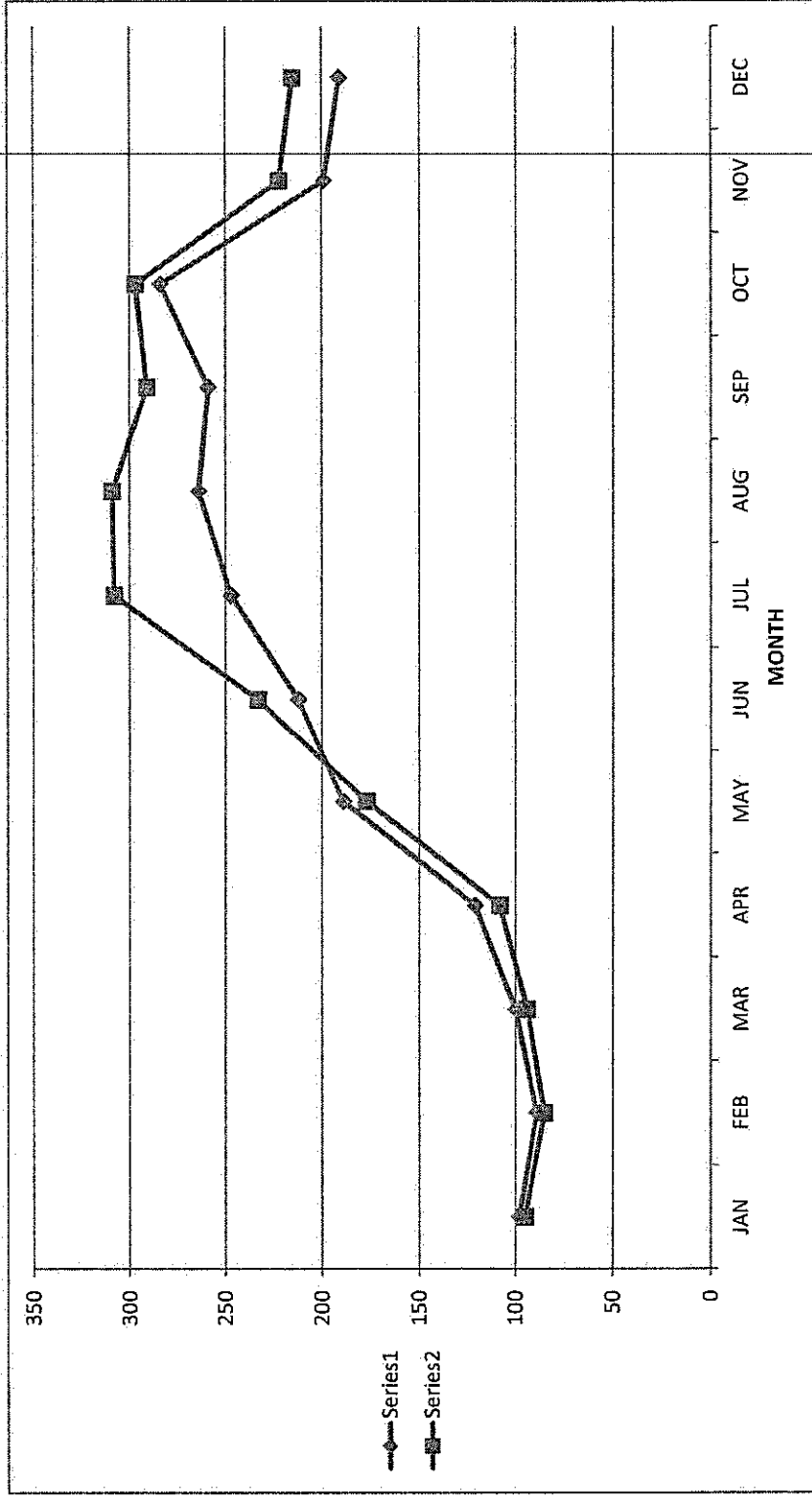

SUSPENDED SOLIDS YEARLY AVERAGE 188 mg/L

BOD YEARLY AVERAGE 203 mg/L

	JAN	FEB	MAR	APR	MAY	JUN	JUL	AUG	SEP	OCT	NOV	DEC
TSS	98	89	100	121	189	212	247	264	259	284	199	191
BOD	95	85	94	108	177	233	308	309	291	297	222	215
Flow	3.07	3.418	2.971	2.754	1.813	1.417	1.041	1.029	0.880	0.868	1.222	1.348
Lb/day	2432	2423	2329	2481	2676	2754	2674	2652	2136	2150.019	2262.509	2417.099
												2448.844

2017 EFFLUENT SUSPENDED SOLIDS & BOD, Lbs/day, Monthly Average

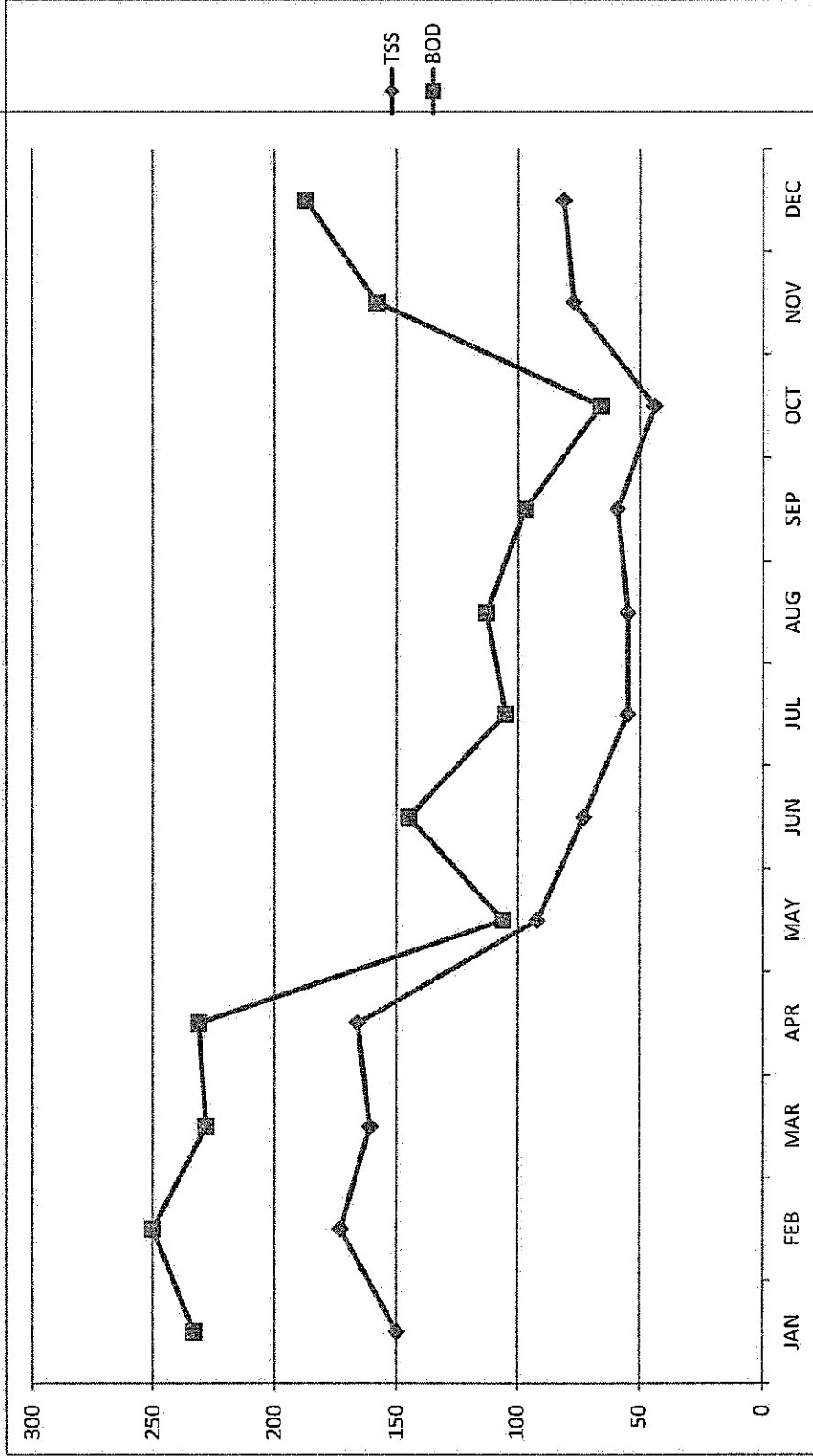

LOADING LIMITS: Weekly AVG BOD 700 lbs/Day, AVG SS 465 lbs/Day
 YEARLY AVG SUSPENDED SOLIDS = 99 lbs/day
 YEARLY AVG BOD = 160 lbs/day

	JAN	FEB	MAR	APR	MAY	JUN	JUL	AUG	SEP	OCT	NOV	DEC
TSS	150	173	161	166	92	73	55	55	59	44	77	81
BOD	233	250	228	231	106	145	105	113	97	66	158	187

CITY OF CRESCENT CITY - SUMMARY OF TREATMENT REPORT
DISCHARGE MONITORING, NPDES PERMIT NO. CA0022756
2017 Annual Report

DEWATERED SLUDGE - BELT PRESS OPERATION										DIGESTER OPERATION	
MONTH	GALLONS PRESS FEED	DRY TONS REMOVED	AVG % SOLIDS CAKE	DAYS RUN	BAGS OF POLYMER USED	AVG. % SOLIDS RAW	AVG % VOLATILE REDUCTION				
JAN	231,670	17.4	17.4	14	2	1.8	59.8				
FEB	169,861	12.0	16.7	12	3	1.7	71.3				
MAR	204,480	12.8	16.9	14	3	1.5	70.2				
APR	231,136	15.4	16.7	17	4	1.6	72.8				
MAY	283,068	21.2	15.7	18	5	1.8	75.7				
JUN	238,700	15.9	15.9	16	4	1.6	77.5				
JUL	251,200	16.8	15.0	20	5	1.6	52.6				
AUG	267,150	17.8	14.9	20	4	1.6	49.9				
SEP	249,020	15.6	14.2	17	5	1.5	54.0				
OCT	267,214	17.8	13.8	21	3	1.6	54.4				
NOV	199,270	14.1	14.3	15	4	1.7	55.1				
DEC	220,403	14.7	15.1	16	4	1.6	59.2				
TOTAL	2,813,172	191.6		200	46						
AVG	234,431	16.0	15.6	17	4	1.6	62.7				
MIN	169,861	12.0	13.8	12	2	1.5	49.9				
MAX	283,068	21.2	17.4	21	5	1.8	77.5				

Dewatered Sludge is taken to Dry Creek Landfill at White City, Oregon
* No samples were taken during the month of December



377 J STREET

CRESCENT CITY, CALIFORNIA 95531-4025

Administration / Finance (707) 464-7483
Utilities (707) 464-6517
WPCF (707) 464-5416

Public Works / Planning (707) 464-9506
Fax (707) 464-4405
Construction (707) 464-6319

February 28, 2019

Regional Water Quality Control Board
Northcoast Region
5550 Skylane Boulevard Suite A
Santa Rosa, CA 95403

Attention: Cathy Goodwin

RE: NPDES CA0022756 - WDID 1A84006ODN

Dear Ms. Goodwin

Enclosed, please find the 2018 ANNUAL REPORT for the City of Crescent City Water Pollution Control Facility, located at 210 Battery Street, WDID Number 1A84006ODN, required under NPDES Permit Number CA0022756.

In 2018 we had no violations of permit conditions. Overall operation of the facility was excellent during the period.

In regards to permit special Provision Requirements, key activities included:

- Submittal and approval of Outfall Inspection Plan – IX.A
- Identify Financing – IV.C.2.d.
- Submittal and Approval of Biological Survey Workplan – MRP section IX.B
- Submittal of 10-year financial plan – VI.C.2.d
- Completion of DMR QA-38 - MRP section I.F

In terms of facility O&M, two of our operators have passed and have obtained a Grade III license. Our current CPO has taken and passed the Grade V exam.

We have experienced several material equipment breakdowns during the year. Our teams rapid response to these emergencies helped us avoid exceedance or material impacts to the facility. The three equipment events consisted of:

- Failure of a major roller bearing on a Rotating Biological Contactor which caused the unit to go offline for several days. The repair was completed in April 2018 and returned to service with no adverse impacts to plant effluent.
- The dewatering system belt press primary drive gear failed in June causing the press to be out of service for 4 days. Replacement parts were ordered on an expedited basis. During this period, to avoid a digester overflow, several truckloads of sludge were transported by roto roter to the Brookings Roter Rooter facility for final disposal at the Heard Farms Treatment Facility Roseburg Oregon. There were no impacts to plant effluent.
- Gravity thickener bearing failed and was replaced in September. This required the unit to be out of service for sveral days. The work was performed with no impacts to plant effluent.

Also during 2018, the facility installed a new system to demonstrate that the final effluent chlorine residual is zero. The system was installed in compliance with the NPDES permit special Provision VI.C2.and also satisfies the requirement of Administrative Civil Liability ACL R1-2017-0049. We are still in the pilot project phase with this new equipment and plan to have it fully functional with one month of test data by the end of March.

Looking forward the City has initiated an RFP process to evaluate use of a third-party operator for operation of the Water Quality Laboratory and the WWTP. The goal of the RFP is to determine if the facility can be better maintained and operated using a third party. Other goals are to improve efficiencies and reduce life-cycle costs.

I certify under penalty of law that this document and all attachments were prepared under my direction or supervision in accordance with a system designed to assure that qualified personnel properly gather and evaluate the information submitted. Based on my inquiry of the person or persons who manage the system, or those persons directly responsible for gathering the information, the information submitted is, to the best of my knowledge and belief, true, accurate, and complete. I am aware that there are significant penalties for submitting false information, including the possibility of fine and imprisonment for knowing violations.” [40 CFR §122.22(d)]

If you have any questions about this annual report, please contact me at (707) 465-3129.

Regards,

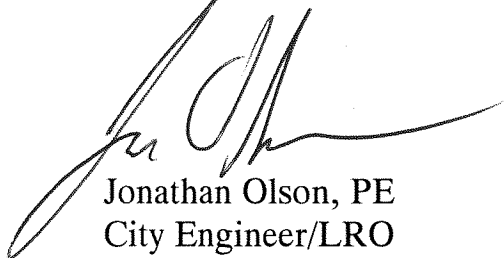
A handwritten signature in black ink, appearing to read 'Jon Olson', with a long horizontal flourish extending to the right.

Jonathan Olson, PE
City Engineer/LRO
City of Crescent City
Water Pollution Control Facility

Annual Report in Permit Format includes:

- Attachment 1 – (Section I) Graphical Summary
(Section II) Sludge Monitoring Results
- Attachment 2 – Plant Process Diagram
- Attachment 3 – DMR-QA 38 Study
- Attachment 4 – Annual Pretreatment

Crescent City 2018 Annual Report
ORDER NO. R1-2017-0002
NPDES NO. CA0022756
WDID NO. 1A84006ODN

Item 1- Where appropriate, tabular and/or graphical summaries of the monitoring data and disposal records from the previous year. If the Permittee monitors any pollutant more frequently than required by this Order, using test procedures approved under 40 C.F.R. part 136 or as specified in this Order, the results of this monitoring shall be included in the calculation and report of the data submitted SMR.

Results are included as Attachment 1: SECTION I

Item 2. A comprehensive discussion of the Facility's compliance (or lack thereof) with all effluent limitations and other WDRs, and the corrective actions taken or planned, which may be needed to bring the discharge into full compliance with the Order.

Included as Attachment 1: SECTION I

Item 3. The names and general responsibilities of all persons employed at the Facility;

See attached matrix and directory of WWTP Personnel-

<u>Grade</u>	Name	Title	Responsibilities
Grade V	Tom Romesberg	Utility Manager/CPO	Supervisor (no longer w/ City)
Grade IV (now V)	Jesse Wood	Senior Operator (Current CPO)	Operations Lead & Training Operators
Grade III	Elizabeth Martinez	Operator	Operations (no longer w/ City)
Grade III	Austin Nova	Operator	Operations
Grade 2 (now III)	Trevor McCaffrey	Operator	Operations

Item 4 The names and telephone numbers of persons to contact regarding the Facility for emergency and routine situations;

Jesse Wood (707) 465-3129	(707) 951-3225
Eric Wier (707) 464-9506	(707) 951-3016
Jon Olson (707) 464-9506	(707) 951-3275

Item 5. A statement certifying when the flow meter(s) and other monitoring instruments and devices were last calibrated, including identification of who performed the calibration.

Calibration and adjustment performed on effluent meter in November 2018 by City Electrical Operational Maintenance Technicians and third party controls specialist
--

Item 6 - Sludge Handling and Disposal Activity Reporting. The Permittee shall submit, as part of its annual report to the Regional Water Board, a description of the Permittee’s solids handling, disposal and reuse activities over the previous 12 months. At a minimum, the report shall contain:

i. Annual sludge production, in dry tons and percent solids;

120.9 dry tons sewage sludge at 14.6%solids were generated in 2018
--

ii. Sludge monitoring results;

Results are included as Attachment 1: SECTION II

iii. A schematic diagram showing sludge handling facilities (e.g., digesters, thickeners, drying beds, etc.), if any and a solids flow diagram;

See Plant Diagram included as Attachment 2

iii. Methods of final disposal of sludge:

Disposal at White City Oregon Landfill, a Municipal Landfill Under 40 CFR 258

Item g. Storm Water Reporting.

The City of Crescent City is MS4 Exempt. Industrial Stormwater permit not required as all stormwater drains to headworks.

Item h. Septage Monitoring and Reporting. The results of septage monitoring shall be provided as follows: i. A narrative description of all preparatory, monitoring, sampling, and analytical testing activities for the septage monitoring program. The narrative shall be sufficiently detailed to verify compliance with waste discharge requirements and this MRP.

Currently not approved for septage. A Prop 1 grant request to install a septage receiving facility has been submitted to the State Water Resources Control Board.

Item i. DMR-QA Study Report. The Permittee shall submit, as part of its annual report to the Regional Water Board, an electronic copy of the annual DMR-QA study report submitted to the State Water Board, Quality Assurance Program Officer pursuant to section I.F of this MRP.

Included as Attachment 3 are the result of DMRQA-38

Annual Pretreatment Reporting Requirements. The Permittee shall submit annually

Included as Attachment 4

**CRESCENT CITY
WASTEWATER TREATMENT PLANT
2018 ANNUAL REPORT**

SECTION I

WWTP SUMMARY

SECTION II

DEWATERED SLUDGE

SECTION I

SECTION I
WWTP SUMMARY REPORT

CITY OF CRESCENT CITY - SUMMARY OF TREATMENT
DISCHARGE MONITORING - NPDES PERMIT NO. CA0022756
2018 ANNUAL REPORT

Month	Flow MGD Avg	PH	TOTAL CL2 mg/L	SETTLABLE SOLIDS EFF	SUSPENDED SOLIDS			INF	BOD5 EFF	LBS/DAY	FECAL MPN MEDIAN	GREASE AND OIL	TURBIDITY	MONTH TOTAL RAINFALL IN
					INF	EFF	LBS/DAY							
Jan	1.697	7.3	<0.05	0.38	190.0	9.2	126	199.0	17.7	235	4.5	<5.0	6.5	12.36
Feb	1.385	7.3	<0.05	<0.1	171.0	7.9	91	184.0	13.6	156	2	<5.0	5.7	4.15
Mar	2.371	7.2	<0.05	<0.1	122	8.5	170	122.0	18.1	326	2	<5.0	5.5	14.44
Apr	1.718	7.3	<0.05	<0.1	125	7.8	112	132	16.6	238	2	<5.0	5.6	5.62
May	1.141	7.3	<0.05	<0.1	177	7.8	75.0	204	14.7	146	4.5	<5.0	5.8	1.07
Jun	0.995	7.2	<0.05	<0.1	233	7.6	62.0	265	12.2	99	8	<5.0	4.0	0.79
Jul	0.904	7.4	<0.05	<0.1	238	7.5	56.0	282	14	106	7.8	<5.0	4.4	0.07
Aug	0.895	7.4	<0.05	<0.1	229	10	74.0	283	15.7	116	4.5	<5.0	5.6	0.17
Sep	0.871	7.3	<0.05	<0.1	242	8.9	64.0	292	11.5	82.0	6.8	<5.0	5.3	0.23
Oct	0.890	7.4	<0.05	<0.1	234	8.3	61.0	302	13.3	98.0	4.5	<5.0	4.5	2.24
Nov	0.930	7.48	<0.05	<0.1	205	10.1	79.0	277	19.9	154	2	<5.0	8.2	6.63
Dec	1.129	7.4	<0.05	<0.1	202	9.6	91	240	15.9	149	2	<5.0	5.9	8.5
TOTAL	14.926													56.27
AVG	1.244	7.3	<0.05	<0.1	197	8.6	88	232	15.3	159	4.2	<5.0	5.6	4.69
MIN	0.871	7.2	<0.05	<0.1	122	7.5	56	122	11.5	82	2	<5.0	4	0.07
MAX	2.371	7.48	<0.05	0.38	242	10.1	170	302	19.9	326	8	7.6	8.2	14.44

DISCHARGE LIMITS: Ph limits 6.0 min to 9.0 max

30 DAY AVG				0.01			700			45	1050	14	25	75
7 DAY AVG							465			30	700		40	100
1 DAY MAX			0.24	0.2								43	75	225

CITY OF CRESCENT CITY - SUMMARY OF TREATMENT
DISCHARGE MONITORING - NPDES PERMIT NO. CA0022756
2018 ANNUAL REPORT

MONTH	FLOW MGD TOTAL	CALCULATED			VIOLATIONS					
		TSS% REMOVAL	BOD% REMOVAL		PARAMETER	MONTH	DAILY	# OF TESTS RUN	% MONTHLY VIOL	% DAILY VIOL
JAN	1.697	95.2	91.1		pH	0	0	367	0	0
FEB	1.385	95.4	92.6		CL2 RES	0	0	365	0	0
MAR	2.371	93.0	85.2		SET SOLIDS	0	0	367	0	0
APR	1.718	93.7	87.5		TSS EFF mg/L	0	0	154	0	0
MAY	1.141	95.6	92.6		TSS #/DAY	0	0	154	0	0
JUN	0.995	96.7	95.4		BOD EFF mg/L	0	0	154	0	0
JUL	0.904	96.9	95.0		BOD #/DAY	0	0	148	0	0
AUG	0.895	95.6	94.5		FECAL COLI	0	0	12	0	0
SEP	0.871	96.3	96.1		GREASE & OIL	0	0	366	0	0
OCT	0.890	96.5	95.6		TURBIDITY	0	0			
NOV	0.930	95.1	92.8							
DEC	1.129	95.26	93.4							
TOTAL	14.93				TOTAL VIOL	0	0			
AVG	1.24	95.4	92.6							
MIN	0.871	93.04	85.23							
MAX	2.371	96.86	96.1							

2018 FLOW & RAINFALL

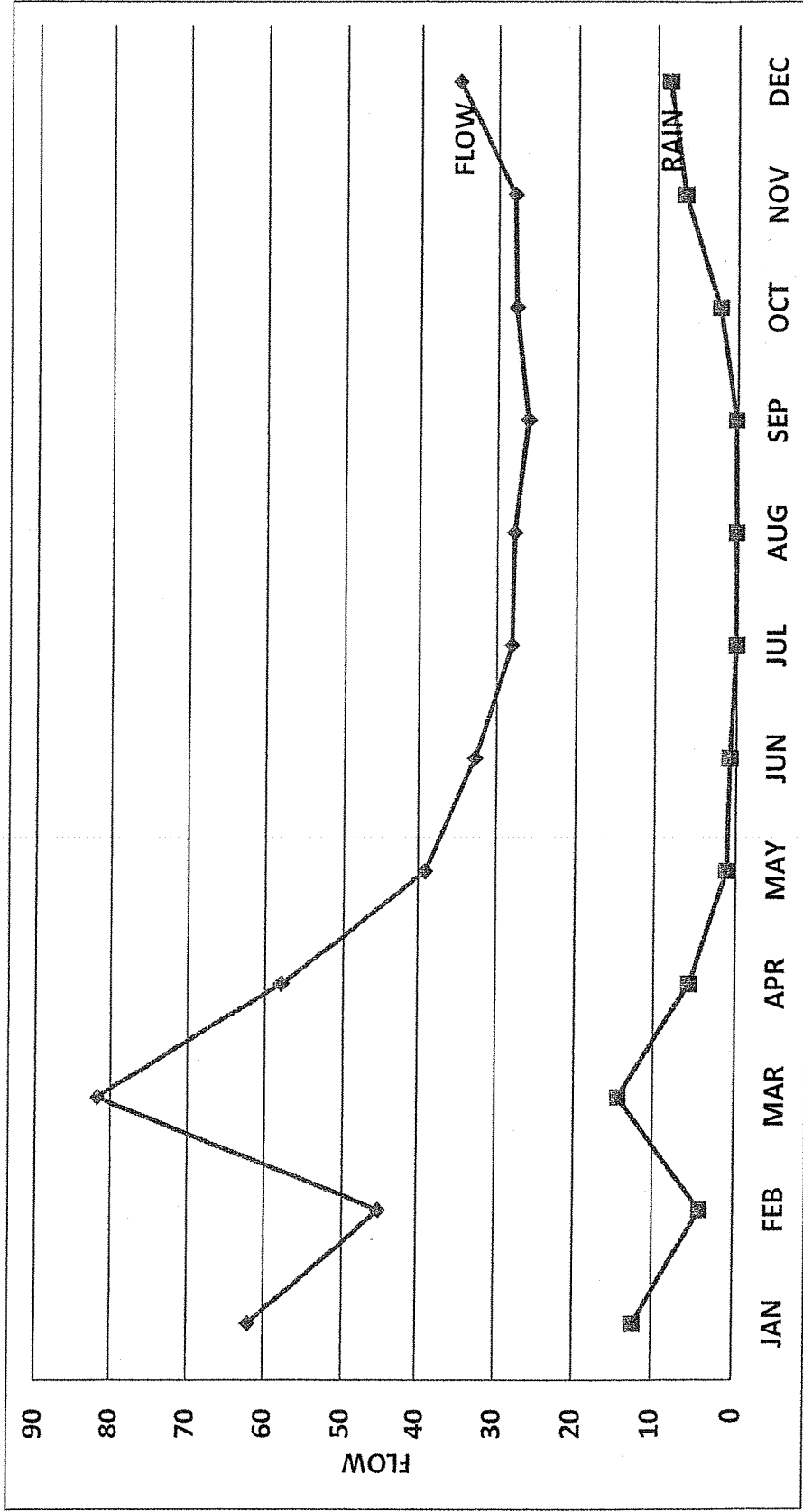

FLOW TOTAL: 491.5 MG
 MONTHLY AVERAGE: 41 MG

RAINFALL ANNUAL TOTAL: 56.27 INCHES
 MONTHLY AVERAGE: 4.69 INCHES

	JAN	FEB	MAR	APR	MAY	JUN	JUL	AUG	SEP	OCT	NOV	DEC
FLOW	62.11	45.18	81.93	57.96	39.13	32.76	28.03	27.76	26.14	27.63	27.84	34.99
RAINFALL	12.36	4.15	14.44	5.62	1.07	0.79	0.07	0.17	0.23	2.24	6.63	8.5

2018 DAILY PLANT FLOW

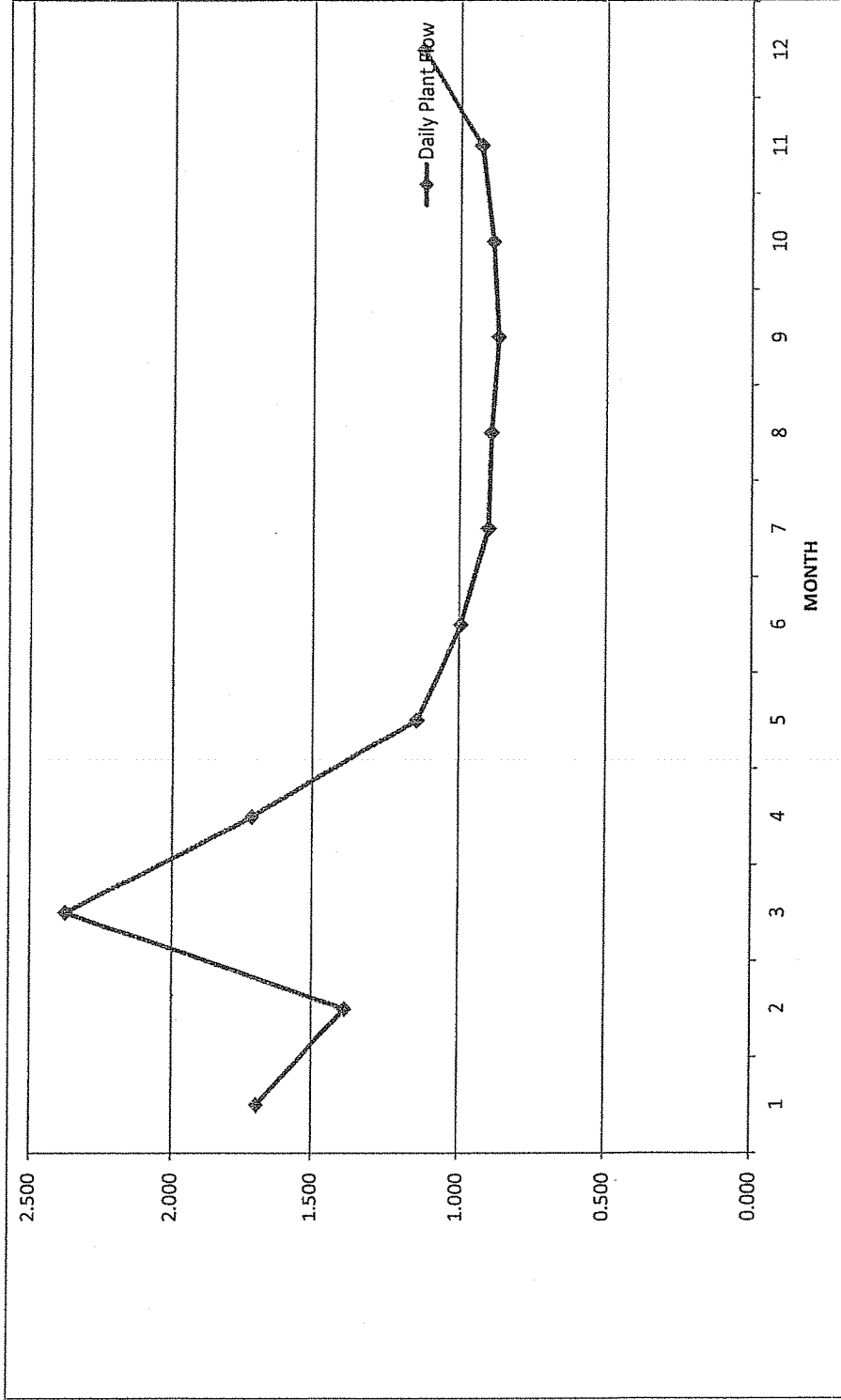

DAILY AVERAGE FLOW 1.819 MILLION GALLONS

	JAN	FEB	MAR	APR	MAY	JUN	JUL	AUG	SEP	OCT	NOV	DEC
AVG	1.697	1.385	2.371	1.718	1.141	0.995	1.041	0.895	0.871	0.890	0.930	1.129
MIN	1.065	1.196	1.711	1.376	0.997	0.913	0.662	0.779	0.793	0.800	0.8	0.923
MAX	3.068	1.745	3.729	2.123	1.311	1.288	1.385	1.009	0.950	1.010	1.18	1.76

2018 INFLUENT SUSPENDED SOLIDS & BOD

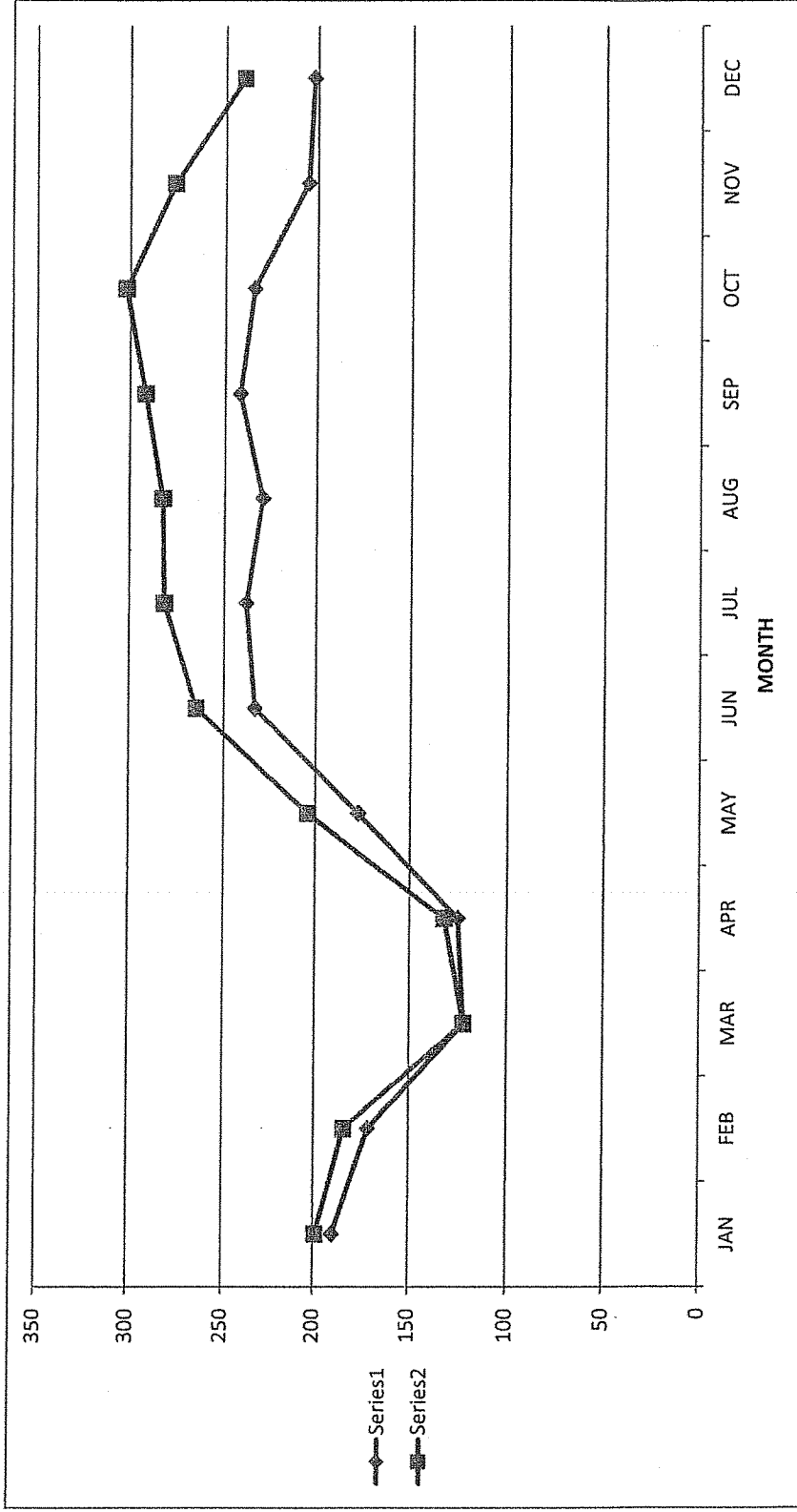

SUSPENDED SOLIDS YEARLY AVERAGE 197 mg/L

BOD YEARLY AVERAGE 232 mg/L

	JAN	FEB	MAR	APR	MAY	JUN	JUL	AUG	SEP	OCT	NOV	DEC
TSS	190	171	122	125	177	233	238	229	242	234	205	202
BOD	199	184	122	132	204	265	282	283	292	302	277	240

2018 EFFLUENT S/S & BOD

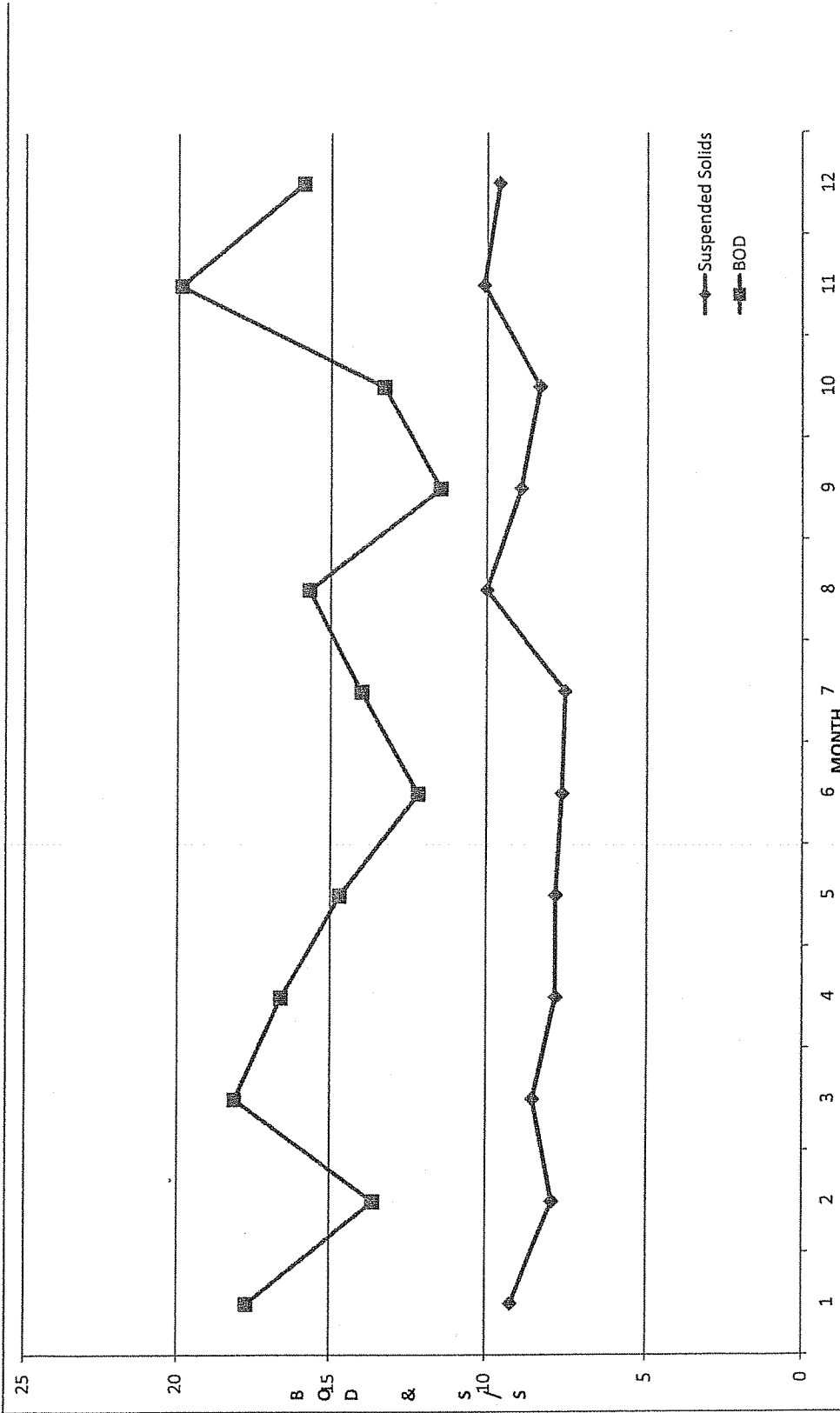

LIMIT 30 mg/L
 SUSPENDED SOLIDS YEARLY AVERAGE 8.6 mg/L
 BOD YEARLY AVERAGE 15.3 mg/L

	JAN	FEB	MAR	APR	MAY	JUN	JUL	AUG	SEP	OCT	NOV	DEC
S.S.	9.2	7.9	8.5	7.8	7.8	7.6	7.5	10.0	8.9	8.3	10.1	9.6
BOD	17.7	13.6	18.1	16.6	14.7	12.2	14	15.7	11.5	13.3	19.69	15.9

2018 EFFLUENT SUSPENDED SOLIDS & BOD, Lbs/day, Monthly Average

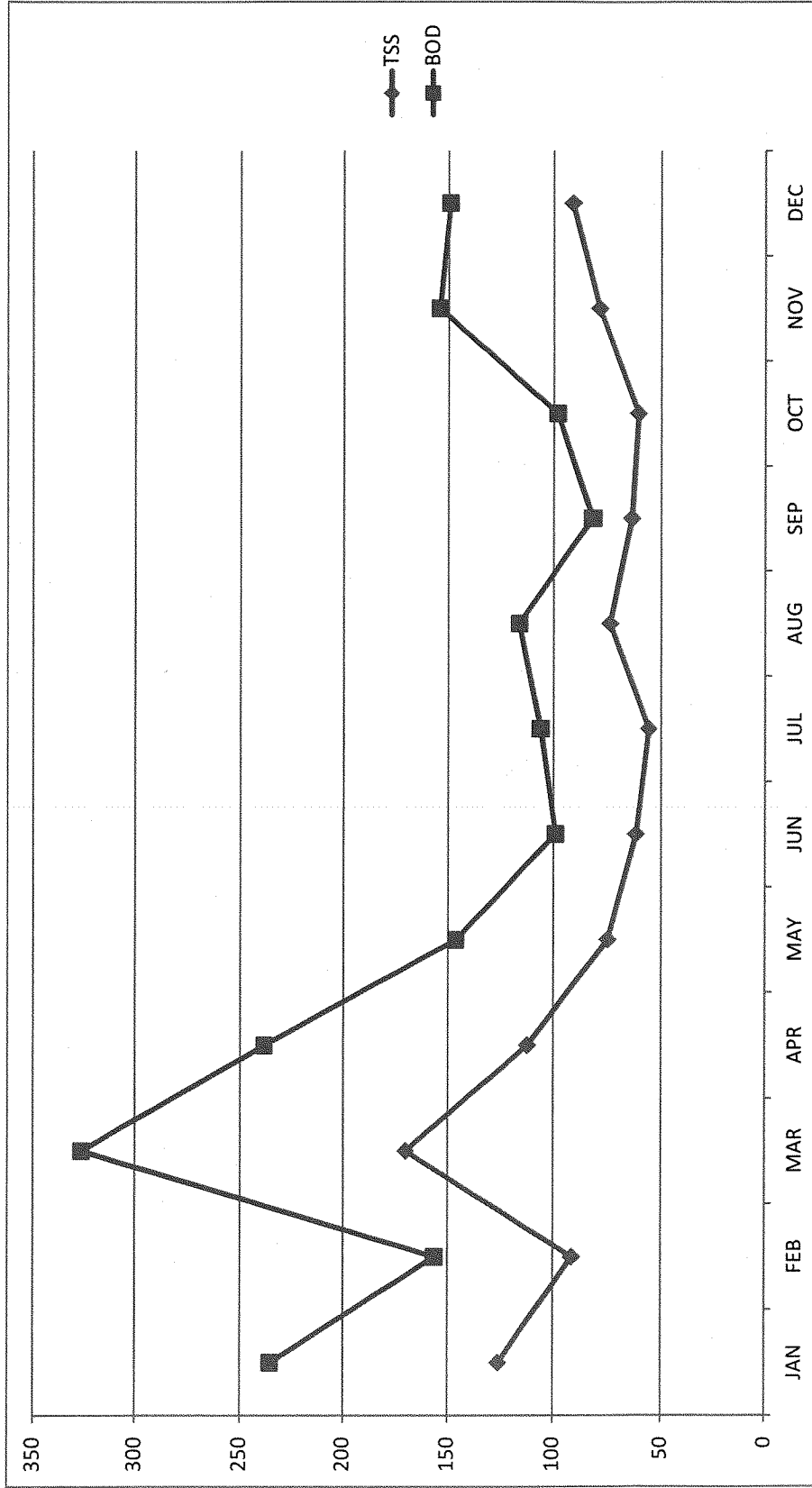

LOADING LIMITS; Weekly AVG BOD 700 lbs/Day, AVG SS 465 lbs/Day
 YEARLY AVG SUSPENDED SOLIDS = 88 lbs/day
 YEARLY AVG BOD = 159 lbs/day

	JAN	FEB	MAR	APR	MAY	JUN	JUL	AUG	SEP	OCT	NOV	DEC
TSS	126	91	170	112	75	62	56	74	64	61	79	91
BOD	235	156	326	238	146	99	106	116	82	98	154	149

2018 FECAL COLIFORM

Median Fecal Coliform

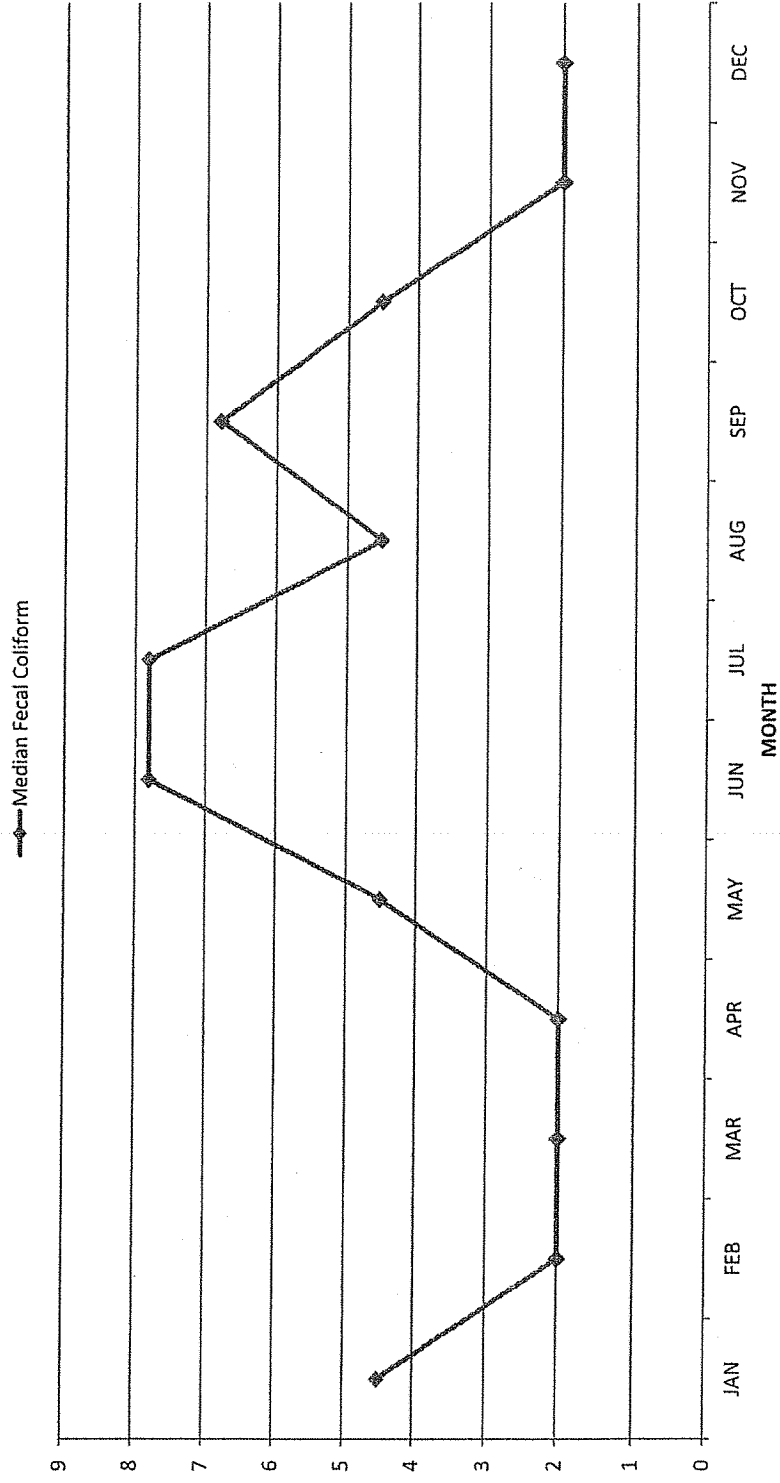

LIMIT 14 MPN MONTHLY MEDIAN

AVERAGE OF MONTHLY MEDIANS:
MONTHS IN VIOLATION

4.2
0

LIMIT NO MORE THAN 10% >43 MPN

MONTHS IN VIOLATION

0

FECAL COLIFORM	JAN	FEB	MAR	APR	MAY	JUN	JUL	AUG	SEP	OCT	NOV	DEC
	4.5	2	2	2	4.5	7.8	7.8	4.5	6.8	4.5	2	2

2018 GREASE & OIL, TURBIDITY

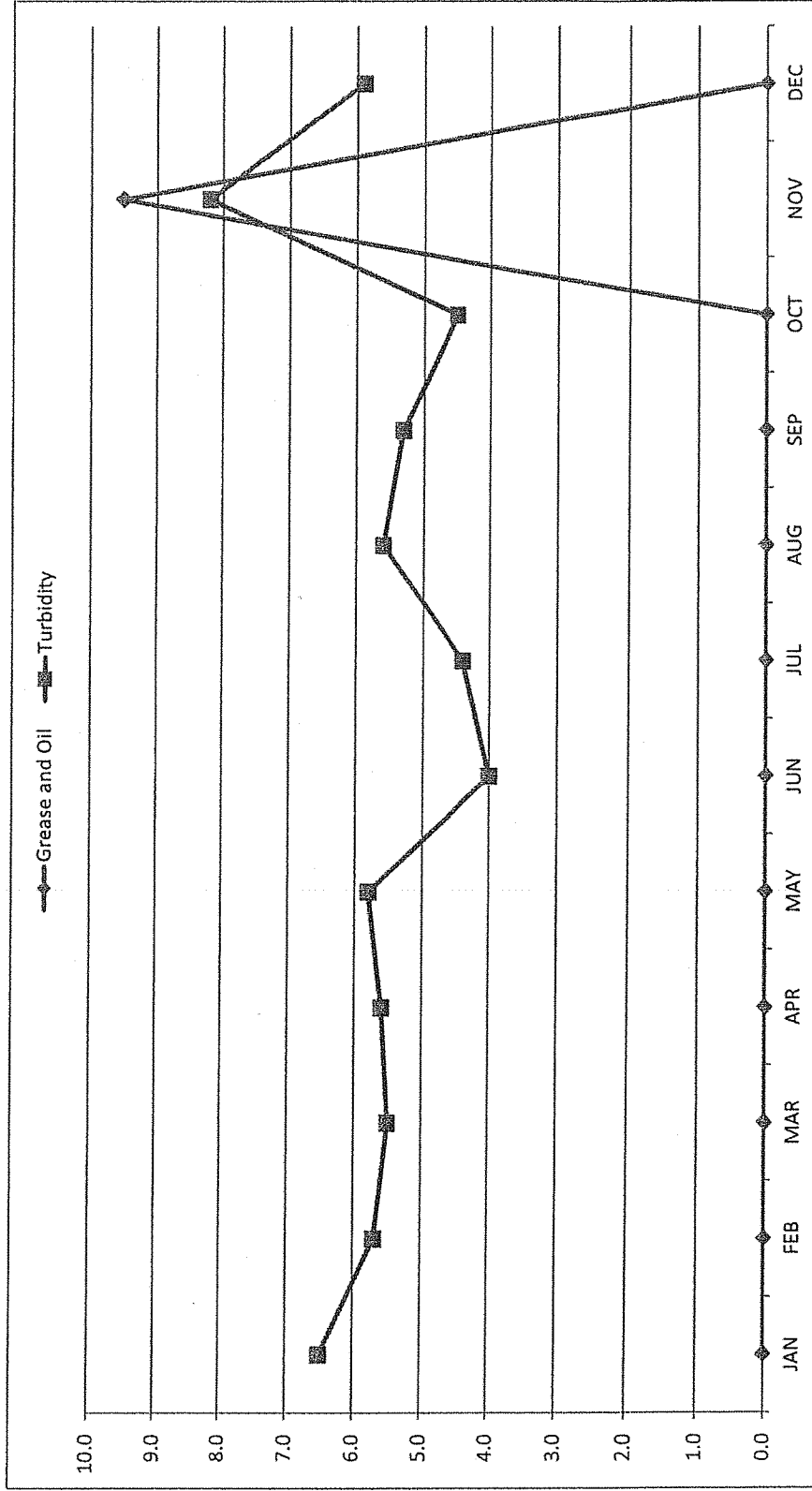

LIMITS; GREASE & OIL - 25mg/L, TURBIDITY - 75 NTU

GREASE & OIL YEARLY AVERAGE <5.0mg/L (3.4mg/l)
 TURBIDITY YEARLY AVERAGE 5.6 NTU

GREASE & OIL & TURBIDITY	JAN	FEB	MAR	APR	MAY	JUN	JUL	AUG	SEP	OCT	NOV	DEC
GREASE & OIL	<6.1	<6.2	<5.3	<6.2	<6	<5.8	<4.8	<5.9	<5.6	<5.8	9.5	<5.3
TURBIDITY	6.5	5.7	5.5	5.6	5.8	4.0	4.4	5.6	5.3	4.5	8.2	5.9

WWTP BOD/TSS % REDUCTION For 2018

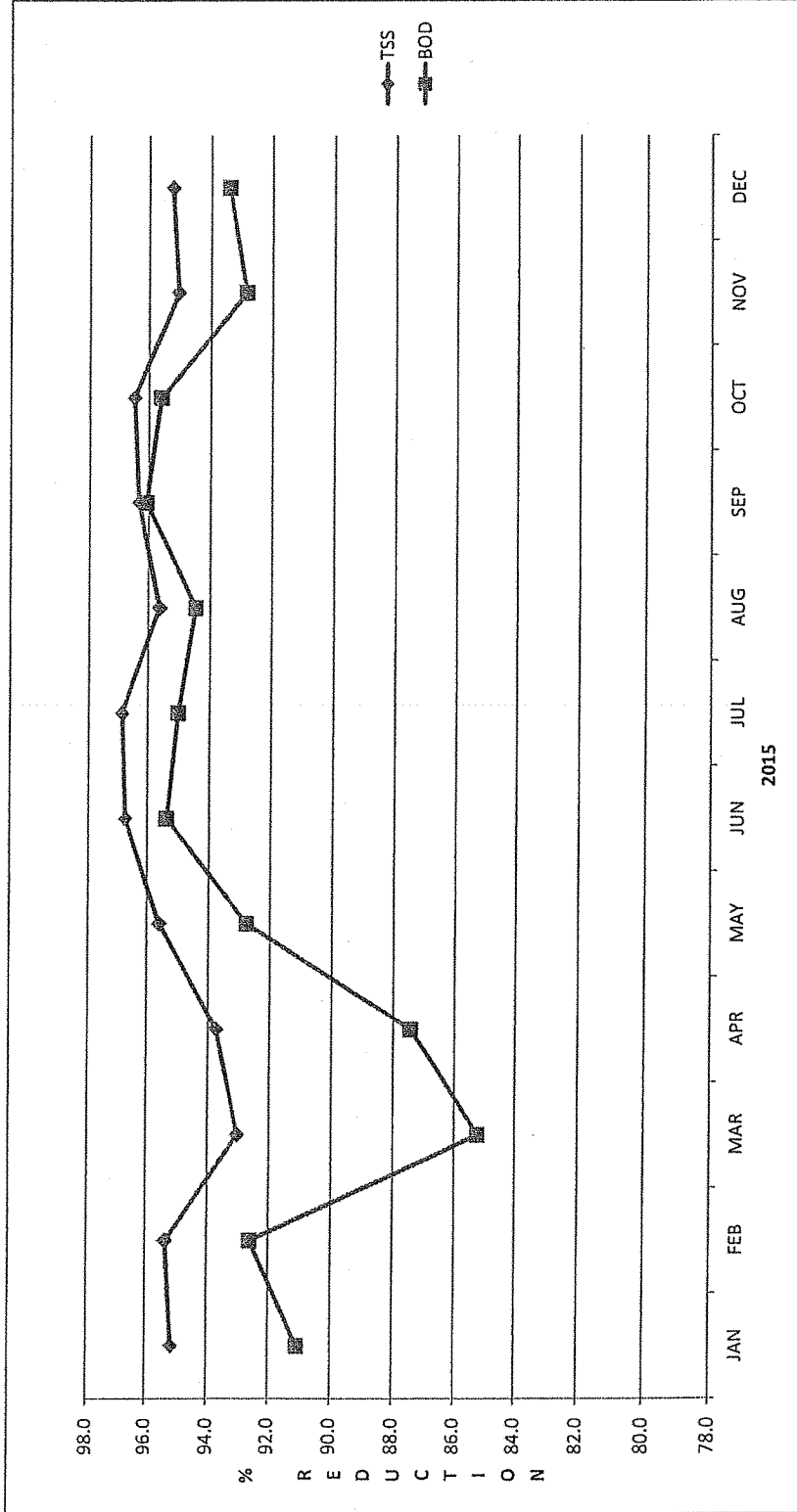

SUSPENDED SOLIDS YEARLY AVERAGE 95.4 %

BOD YEARLY AVERAGE 92.7 %

	JAN	FEB	MAR	APR	MAY	JUN	JUL	AUG	SEP	OCT	NOV	DEC
TSS	95.2	95.4	93.0	93.7	95.6	96.7	96.9	95.6	96.3	96.5	95.1	95.3
BOD	91.1	92.6	85.2	87.5	92.8	95.4	95.0	94.5	96.1	95.6	92.8	93.4

SECTION II
DEWATERED SLUDGE

CITY OF CRESCENT CITY - SUMMARY OF TREATMENT REPORT DISCHARGE MONITORING, NPDES PERMIT NO. CA0022756 2018 Annual Report									
DEWATERED SLUDGE - BELT PRESS OPERATION							DIGESTER OPERATION		
MONTH	GALLONS PRESS FEED	DRY TONS REMOVED	AVG % SOLIDS CAKE	DAYS RUN	BAGS OF POLYMER USED	AVG. % SOLIDS RAW	AVG % VOLATILE REDUCTION		
JAN	199,857	10.15	14.79	17	3	1.99	57.37		
FEB	198,272	10.06	14.70	17	4	1.74	51.71		
MAR	223,373	11.85	15.12	20	5	1.90	42.78		
APR	197,929	8.71	14.92	15	3	1.84	60.20		
MAY	218,014	11.66	14.36	17	4	1.75	63.08		
JUN	245,598	11.64	14.80	17	5	1.76	62.42		
JUL	214,376	10.90	13.61	21	5	1.74	61.34		
AUG	220,947	9.68	13.89	21	3	1.74	51.02		
SEP	233,370	9.47	14.99	17	6	1.58	60.81		
OCT	253,015	8.32	14.46	19	3	1.91	60.38		
NOV	170,241	8.22	14.33	16	5	2.06	61.26		
DEC	194,657	10.20	14.93	17	3	2.25	52.30		
TOTAL	2,569,649	120.9	14.58	214	49	1.86	57.06		
AVG	214,137	10.1	14.6	18	4	1.9	57.1		
MIN	170,241	8.2	13.6	15	3	1.6	42.8		
MAX	253,015	11.9	15.1	21	6	2.3	63.1		

Dewatered Sludge is taken to Dry Creek Landfill at White City, Oregon

February 26, 2020

Regional Water Quality Control Board
Northcoast Region
5550 Skylane Boulevard, Suite A
Santa Rosa, CA 95403

Attention: Cathy Goodwin

RE: NPDES CA0022756 – WDID 1A840060DN

Enclosed, please find the 2019 Annual Report for the City of Crescent City Water Pollution Control Facility, located at 210 Battery Street, WDID Number 1A840060DN, as required under NPDES Permit Number CA0022756.

In 2019, the following exceedances of permit conditions occurred:

A Chlorine effluent violation on 1/3/19, a fecal effluent limitation exceeded on 7/8/19, an Oil and Grease exceedance on 9/5/19, a copper effluent exceedance on 9/6/19, and Sanitary Sewer Overflows that are detailed in Attachment 3.

Also, as part of the local limits sampling and analysis the results for Lindane on Influent and Effluent were both non-detect. The PET tool does not have a section where that constituent can be added. It was however included in the local limits report and cover letter.

In regard to permit special Provision Requirements, key activities included:

- A source Control and pretreatment Study Local Limits

Based on the Regional Board Comments on the Crescent City Local Limits Work Plan (dated July 24, 2017), a new version of the Work Plan was developed dated (July 12, 2018). Sampling, as described in the Local Limits Work Plan (dated July 12, 2018,) was performed during the next dry season in September 2019. Data from the September 2019 sampling event are being evaluated to determine if modification of the existing local limits are warranted. A Local Limits Evaluation Report will be available by July 1, 2020.

- Review and/or update Sewer Use Ordinance (2021 Submittal)
- Climate change readiness plan (2021 submittal)
- Financial Plan Submitted in 2018
- Pollutant Minimization Program

City is not aware of any evidence that a toxic pollutant is present in the effluent at a concentration greater than an applicable effluent limitation.

- Outfall Evaluation / Inspection report

The city's outfall evaluation work plan was approved in 2018. The city performed CCTVing of the outfall lines in 2019 and is currently work on the remainder of the report. The report will be submitted no later than 1 April 2020.

- Biological Survey

The Bio survey is ongoing. The final report will be submitted no later than 1 April 2021.

Annual report and update:

In 2019 the City solicited proposals from contract operations firms to operate and manage the Crescent City Wastewater Treatment Facility. The City chose the team from Operations Management International, Inc (OMI) also known as Jacobs Engineering Group as the successful bidder and entered into a professional service contract. OMI took over responsibility for operations and maintenance on September 9, 2019. Prior to that time the facility continued to be run by the City. OMI's contract term is from September 9, 2019 until June 30, 2025.

Jacobs Engineering staff include certified Grade V, Grade IV and Grade III operators as well as Operators-in-Training and a plant mechanic.

Plant maintenance is recorded on a computer maintenance management system and operations activities are recorded daily in a treatment plant log book.

There were a number of major equipment repair and replacement activities that took place in 2019. It should be noted that there weren't any equipment issues that were critical in nature that would have been considered an emergency. Major maintenance items attended to in 2019;

1. Influent Screen A rebuild of brushes, wear plates and gearbox
2. Belt press improvements. Replaced doctor blades, hydraulic motor and wash water booster pump.
3. Rebuilt influent sampler
4. Rebuilt ignition and pilot system for waste gas flare
5. Replaced one plant effluent re-use pump and rebuilt one other
6. Rebuilt automatic sludge feed valves on Digester #1 & #2
7. Replaced aeration basin DO controller and probe mechanism

I certify under penalty of law that this document and all attachments were prepared under my direction and supervision in accordance with a system designed to assure that qualified personnel properly gather and evaluate the information submitted. Based on my inquiry of the person or persons who manage the system, or those persons directly responsible for gathering

the information, the information submitted is, to the best of my knowledge and belief, true, accurate, and complete. I am aware that there are significant penalties for submitting false information, including the possibility of fine and imprisonment for knowing violations. [40 CFR, section 122.22 (d)].

If you have any questions about this annual report, please contact me at (707) 465-3129.

Regards,

Jonathan Olson, PE
City Engineer/LRO
City of Crescent City
Water Pollution Control Facility

Item 1- Where appropriate, tabular, and /or graphical summaries of the monitoring data and disposal records from the previous year. If the Permittee monitors any pollutant more frequently than required by this Order, using test procedures approved under 40 CFR part 136 or as specified in this Order, the results of this monitoring shall be included in the calculation and report submitted by SMR.

Results are included as Attachment # 1: Section I

Item 2- A comprehensive discussion of the Facility's compliance (or lack thereof) with all effluent limitations and other WDRs, and the corrective actions taken or planned, which may be needed to bring discharge into full compliance with the Order.

Included as Attachment # 1: Section I

Based on the Regional Board Comments on the Crescent City Local Limits Work Plan (dated July 24, 2017), a new version of the Work Plan was developed dated (July 12, 2018). Sampling, as described in the Local Limits Work Plan (dated July 12, 2018,) was performed during the next dry season in September 2019. Data from the September 2019 sampling event are being evaluated to determine if modification of the existing local limits are warranted. A Local Limits Evaluation Report will be available by July 1, 2020.

Item 3- The names and general responsibilities of all persons employed at the facility

Directory of WWTP personnel

Name	Grade	Title	Responsibilities
Dennis Burrell	V	Regional Manager	CPO/Supervisor. CPO from July 2019 until Feb 2020
Austin Nova	III	Operator	Daily operations and training
Trevor McCaffrey	III	Operator	Left City, Operator until August 2019
Xavier Knight	OIT	Operator in Training	Operator in Training
Jesse Wood	V	Senior Operator	Left City, CPO/ Senior Operator until July 2019
Richard MacNamara	OIT	OIT	Operator in training
David Zevely	IV	Project Manager	CPO starting Feb 2020, Project manager daily operations and training
Tim Baker		Maintenance Mechanic	Plant equipment maintenance and repair

Item 4-The names and phone numbers of persons to contact regarding the Facility for emergency and routine situations.

OMI Staff		
	Business Hours	After Hours
David Zevely	707-465-3129	
Austin Nova	707-465-3129	
Dennis Burrell	707-465-3129	209-985-1071
City Staff		
Jon Olson	707-464-9506	707-951-3275
Eric Wier	707-464-9506	707-951-3016

Item 5- A statement clarifying when flow meter(s) and other monitoring instruments and devices were last calibrated, including identification of who performed the calibration.

On October 7th, 2019, Technical Systems Inc (TSI) calibrated the wastewater treatment facility effluent meter and on October 8th, the facility's influent meter was calibrated by TSI. Final effluent chlorine dose and residual analyzers are calibrated in-house on a weekly basis.

Item 6- Sludge Handling and Disposal Activity Reporting. The permittee shall submit, as part of its annual report to the Regional Water Board, a description of the Permittee’s solids handling, disposal, and reuse activities over the previous 12 months. At a minimum the report shall contain:

- i. Annual sludge production, in dry tons and percent solids

135 Dry tons of sewage sludge at 15.6 % solids were generated in 2019.

- ii. Sludge monitoring results

Results are included in Attachment #1: Section II

- iii. A schematic diagram showing sludge handling facilities (e.g., digesters, thickeners, drying beds, etc.), if any and a solids flow diagram.

See Plant Diagram included as Attachment #2

- iv. Methods of final disposal of sludge

Sludge is disposed at White City Oregon Landfill, a Municipal Landfill Under 40 CFR 258.

Item 7- Storm water Reporting

The City’s Wastewater Treatment Facility does not require a stormwater permit because onsite stormwater runoff drains to the headworks. The City is also improving onsite water management by installing trench drains and other drainage improvement around the site to further minimize risk. One reported tank overflow did cause water to leave the site. This discharge was not related to stormwater. The \$100k project was bid in December 2019. Project will be completed in 2020.

Item 8-septage Monitoring and Reporting

City of Crescent City is currently not approved for Septage Monitoring and Reporting, so there is no monitoring and reporting information. However, a Proposition 1 grant request to install a septage receiving facility has been submitted to the State Water Resources Control Board.

Item 8-DMR-QA Study Report. The Permittee shall submit, as part of its annual report to the Regional Water Quality Control Board, an electronic copy of the annual DMR-QA study report

submitted to the State Water Board, Quality Assurance Program officer pursuant to Section I.F of the MRP.

Included as Attachment # 4 are the results of the DMRQA-39.

Item 9- Annual Pretreatment Reporting Requirements. The permittee shall submit annually.

The Annual Pretreatment Report is included as Attachment # 4.

**CRESCENT CITY
WASTEWATER TREATMENT PLANT
2019 ANNUAL REPORT
ATTACHMENT #1**

SECTION I

WWTP SUMMARY

SECTION II

DEWATERED SLUDGE

SECTION I

SECTION I
WWTP SUMMARY REPORT

CITY OF CRESCENT CITY - SUMMARY OF TREATMENT
 EFF DISCHARGE MONITORING - NPDES PERMIT NO. CA0022756
 2019 ANNUAL REPORT

MONTH	FLOW			CALCULATED			EFFLUENT VIOLATIONS						
	MGD TOTAL	TSS% REMOVAL	BOD% REMOVAL	PARAMETER	MONTHLY	DAILY	# OF TESTS RUN	% MONTHLY VIOL	% DAILY VIOL				
JAN	43.830	95.9	93.6	pH	0	0	366	0	0				
FEB	60.650	94.5	90.3	CL2 RES	0	1	369	0	0.27100271				
MAR	36.600	94.2	89.8	SET SOLIDS	0	0	374	0	0				
APR	56.040	94.9	88.6	TSS EFF mg/L	0	0	150	0	0				
MAY	34.18	96.8	91.9	TSS #/DAY	0	0	150	0	0				
JUN	27.17	96.1	93.8	BOD EFF mg/L	0	0	150	0	0				
JUL	25.57	96.1	95.0	BOD #/DAY	0	0	150	0	0				
AUG	22.78	96.1	93.3	FECAL COLI	1	1	135	0.74074	0.740740741				
SEP	21.910	97.5	95.6	GREASE & OIL	1	1	19	5.263	5.263157895				
OCT	26.520	97.4	94.1	TURBIDITY	0	0	365	0	0				
NOV	27.490	98.1	95.1	COPPER	0	1	21	0	0				
DEC	41.830	96.46	93.3	NICKEL	0	0	20	0	4.761904762				
TOTAL	424.57			TOTAL VIOL	2	4			0				
AVG	35.38	96.2	92.9										
MIN	21.91	94.23	88.55										
MAX	60.65	98.12	95.6										

2019 EFFLUENT FLOW AND RAINFALL

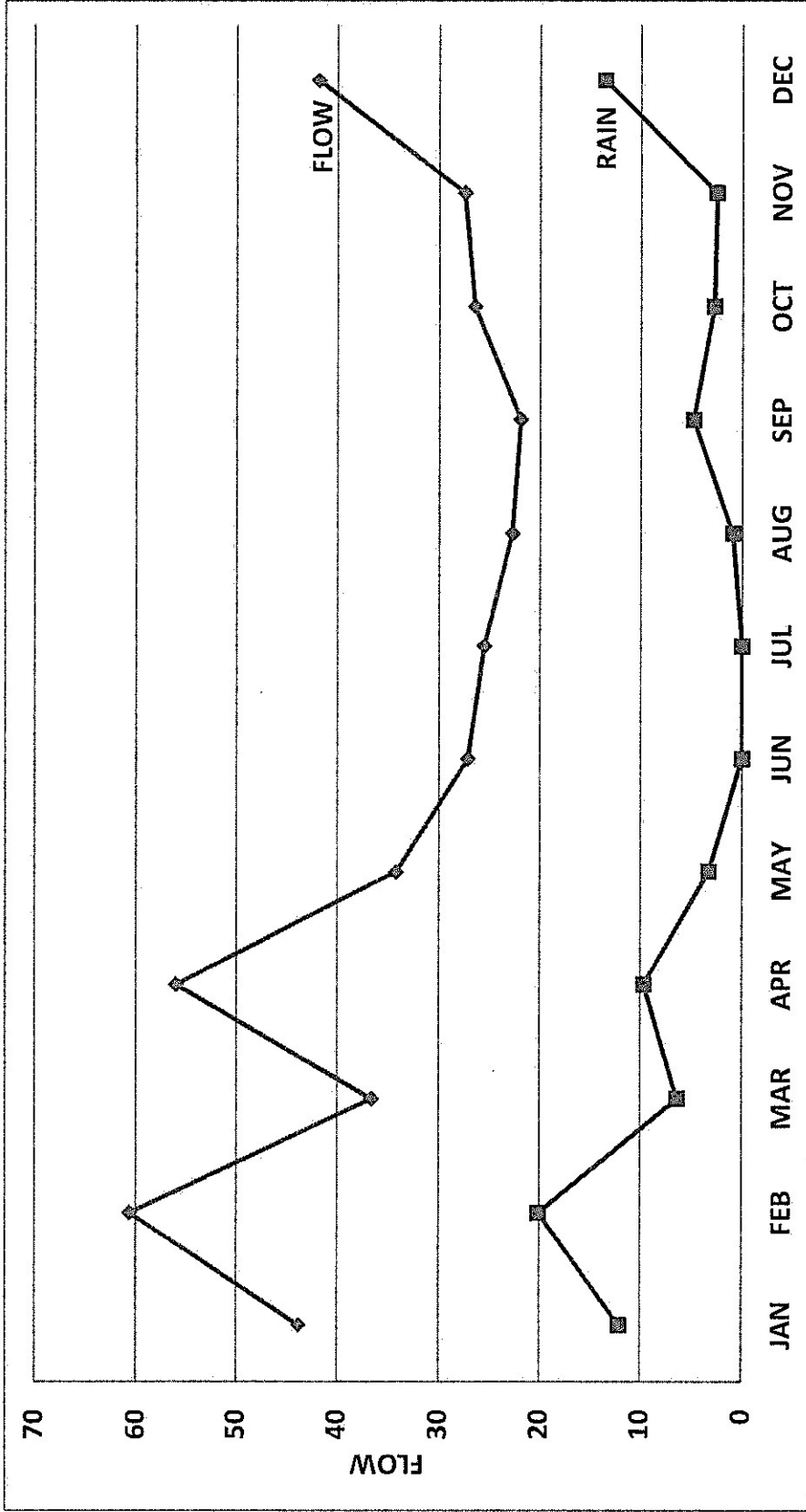

FLOW TOTAL 424.6 MILLION GALLONS
 MONTHLY AVERAGE 35.4 MILLION GALLONS

RAINFALL ANNUAL TOTAL 76.16 INCHES
 MONTHLY AVERAGE 6.35 INCHES

	JAN	FEB	MAR	APR	MAY	JUN	JUL	AUG	SEP	OCT	NOV	DEC
FLOW	43.83	60.65	36.6	56.04	34.18	27.17	25.57	22.78	21.91	26.52	27.49	41.83
RAINFALL	12.10	20.13	6.36	9.68	3.27	0.02	0.02	0.95	4.79	2.77	2.52	13.55

2019 DAILY PLANT FLOW EFF

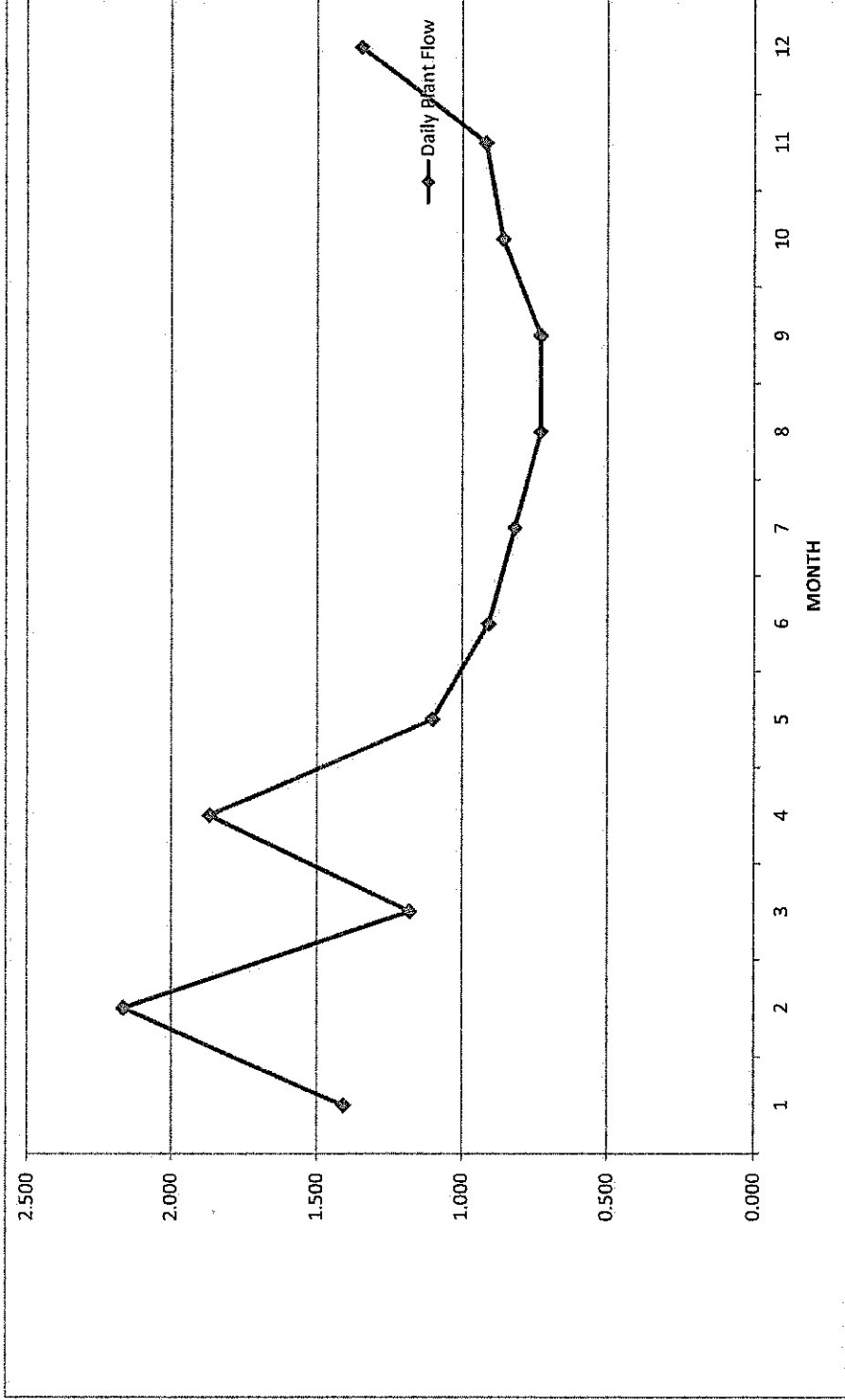

DAILY AVERAGE FLOW 1.171 MILLION GALLONS

	JAN	FEB	MAR	APR	MAY	JUN	JUL	AUG	SEP	OCT	NOV	DEC
AVG	1.410	2.166	1.181	1.870	1.103	0.91	0.82	0.73	0.730	0.860	0.920	1.35
MIN	0.900	1.315	0.729	1.030	0.976	0.82	0.69	0.660	0.65	0.650	0.85	0.8
MAX	3.75	5.164	2.36	5.19	1.363	1.02	1.02	0.83	0.880	1.130	1.1	2.67

2019 INFLUENT TSS & BOD

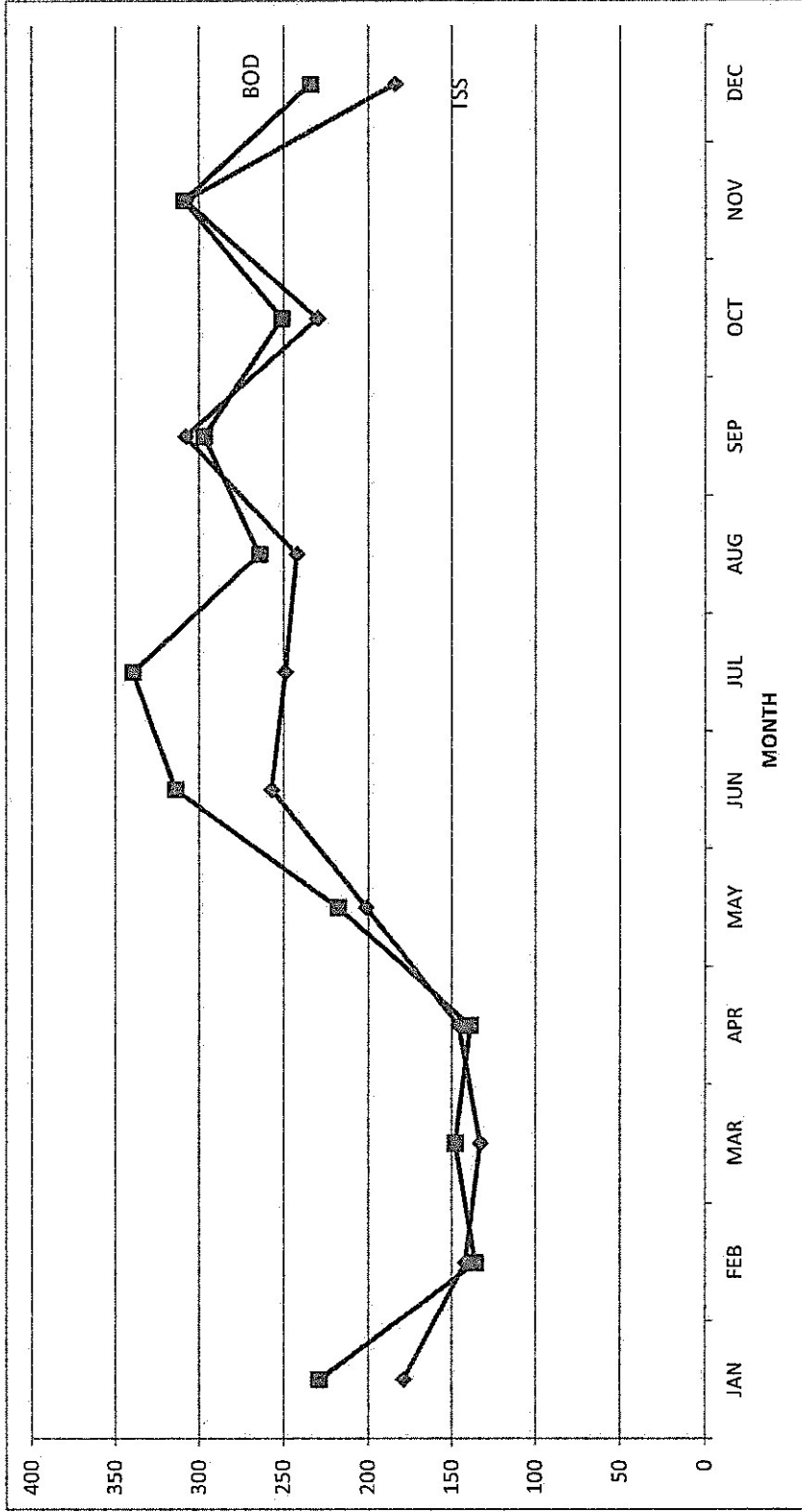

SUSPENDED SOLIDS YEARLY AVERAGE 215 mg/L

BOD YEARLY AVERAGE 240 mg/L

	JAN	FEB	MAR	APR	MAY	JUN	JUL	AUG	SEP	OCT	NOV	DEC
TSS	179	142	133	146	201	257	249	242	308	230	308	184
BOD	229	136	148	139	218	314	339.5	264	297	251	309	234
Flow	1.63	2.955	1.181	1.87	1.35	1.12	1.06	1	1.01	0.99	0.93	1.46
Lb/day	3113	3352	1458	2168	2454	2933	3001	2202	2502	2072.407	2396.666	2849.278

2019 EFFLUENT TSS & BOD

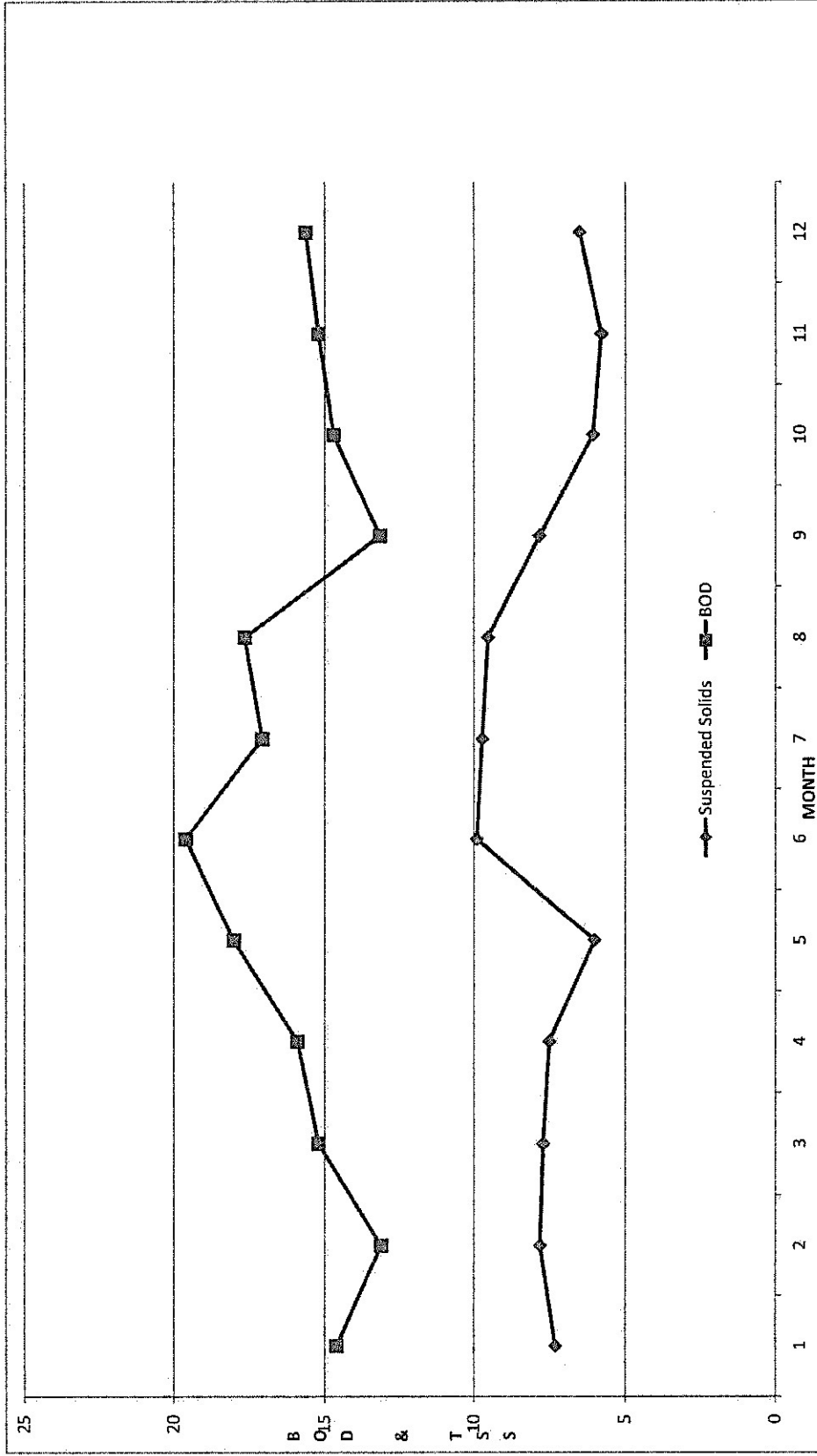

LIMIT 30 mg/L
 TSS YEARLY AVERAGE = 7.64mg/L
 BOD YEARLY AVERAGE = 15.8 mg/L

	JAN	FEB	MAR	APR	MAY	JUN	JUL	AUG	SEP	OCT	NOV	DEC
TSS	7.3	7.8	7.7	7.5	6.0	9.9	9.7	9.5	7.8	6.1	5.8	6.5
BOD	14.6	13.1	15.2	15.9	18	19.6	17.1	17.6	13.2	14.7	15.2	15.6
FLOW	1,410	2,166	1,181	1,87	1,103	0.91	0.82	0.73	0.730	0.86	0.92	1.35
BOD LBS/Day	171.7	236.6	149.7	248.0	165.6	148.8	118.0	111.0	80.7	108.0	119.0	167.0

2019 EFFLUENT SUSPENDED SOLIDS & BOD, Lbs/day, Monthly Average

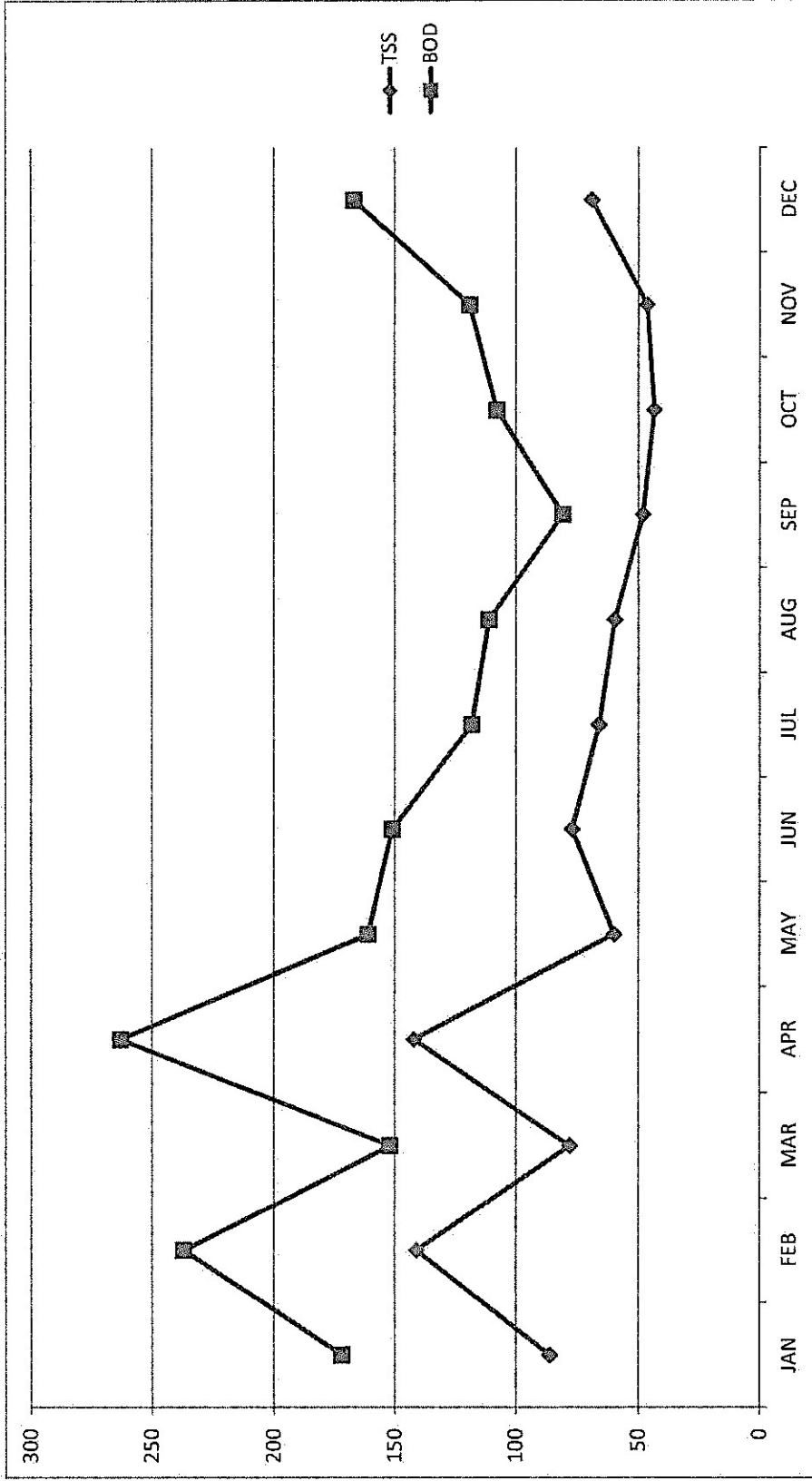

LOADING LIMITS: Weekly AVG BOD 700 lbs/Day, AVG SS 465 lbs/Day

YEARLY AVG SUSPENDED SOLIDS = 76 lbs/day

YEARLY AVG BOD = 153 lbs/day

	JAN	FEB	MAR	APR	MAY	JUN	JUL	AUG	SEP	OCT	NOV	DEC
TSS	86	141	78	142	60	77.03	66.1	59.7	48.2	43.4	46.4	69
BOD	172	237	152	263	161	151	118	111	80.8	107.8	119	167

2019 FECAL COLIFORM

Median Fecal Coliform

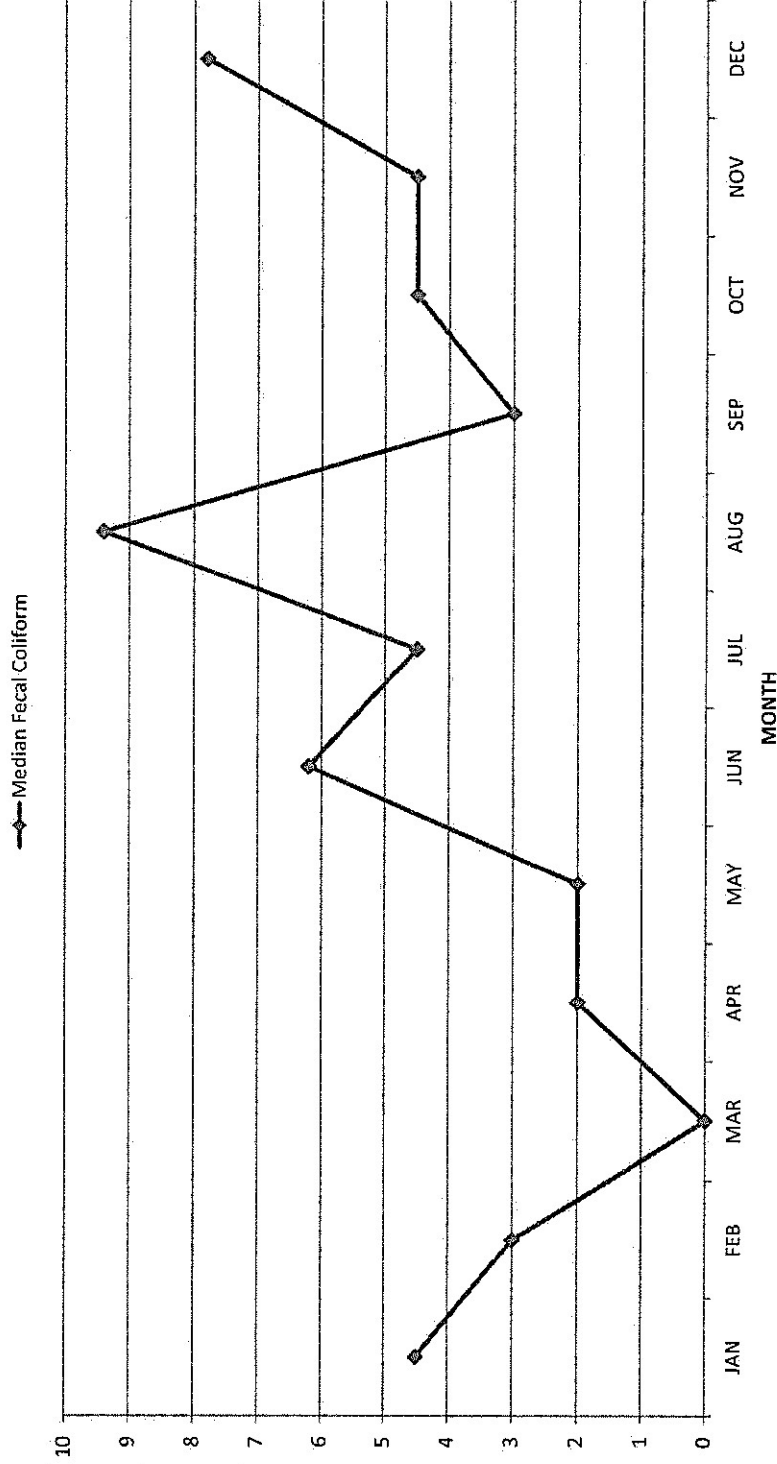

LIMIT 14 MPN MONTHLY MEDIAN

MEDIAN YEARLY AVERAGE = 4.7

MONTHS IN VIOLATION = 1

DAYS IN VIOLATION = 1

MONTHS IN VIOLATION = 8.33%

DAYS VIOLATION 0.74% (1 OUT OF 135 TESTS)

FECAL COLIFORM	JAN	FEB	MAR	APR	MAY	JUN	JUL	AUG	SEP	OCT	NOV	DEC
	4.5	3	<1.8	2	2	6.2	4.5	9.4	3	4.5	4.5	7.8

2019 GREASE & OIL, TURBIDITY

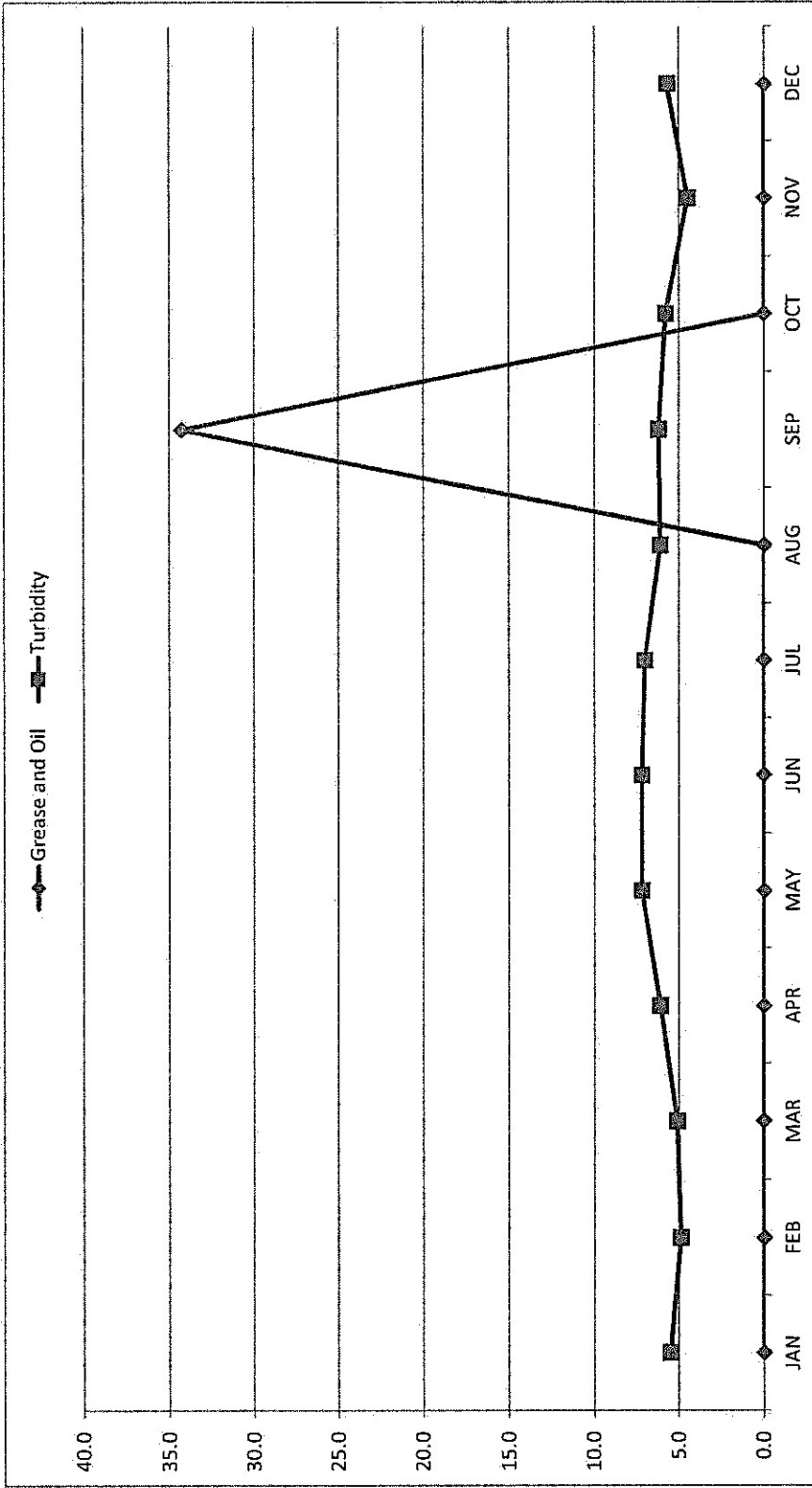

LIMITS; GREASE & OIL - 25mg/L, TURBIDITY - 75 NTU

GREASE & OIL YEARLY AVERAGE <5.0mg/L
TURBIDITY YEARLY AVERAGE 5.9 NTU

GREASE & OIL TURBIDITY	JAN	FEB	MAR	APR	MAY	JUN	JUL	AUG	SEP	OCT	NOV	DEC
GREASE & OIL	<6.2	<5.8	<5.7	<5.1	<5.5	<4.7	<5.1	<5.3	34.3	<5	<4.8	<4.8
TURBIDITY	5.5	4.9	5.1	6.1	7.2	7.2	7.03	6.1	6.2	5.8	4.5	5.7

WWTP BOD/TSS % REDUCTION for 2019

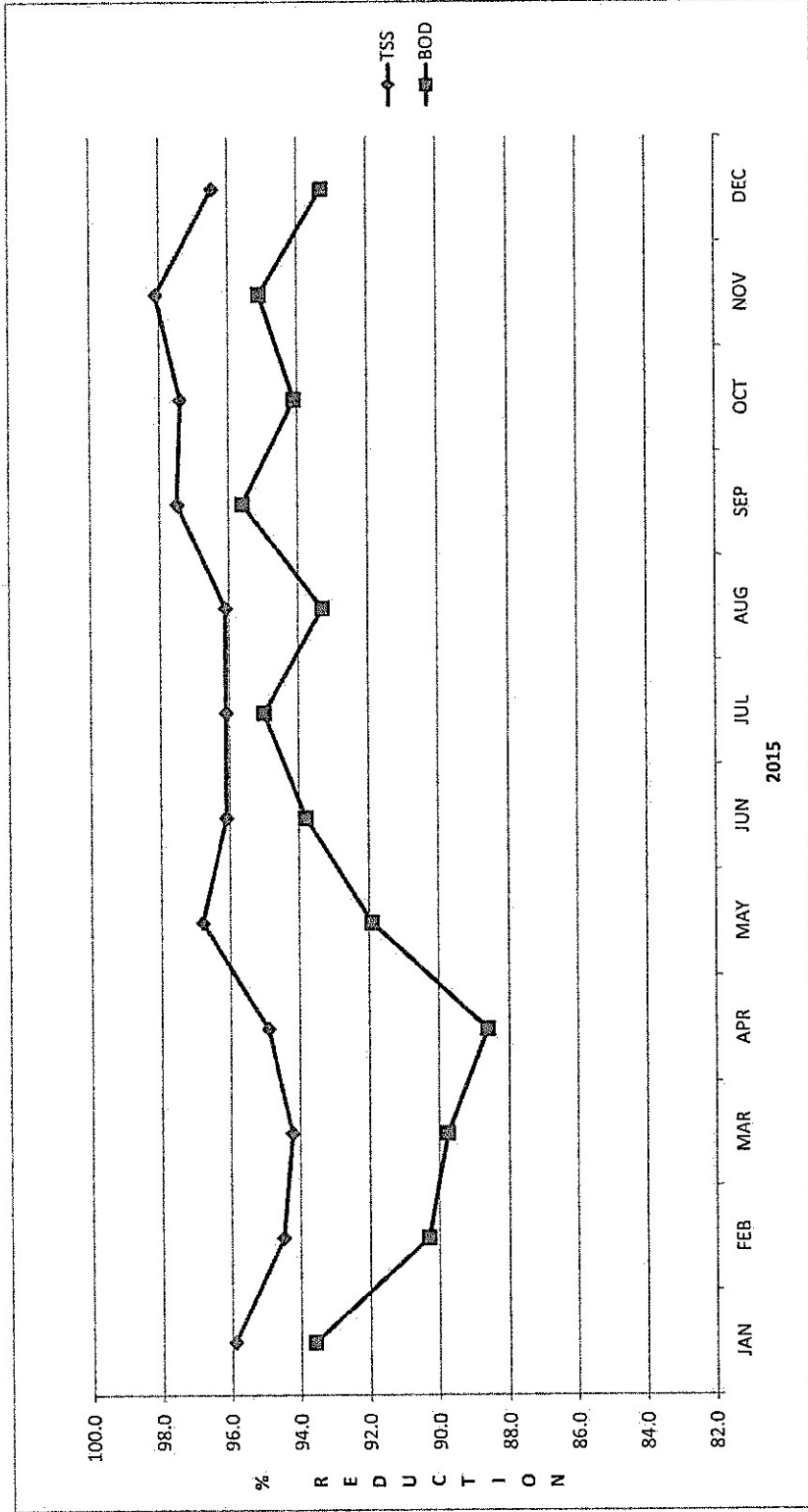

SUSPENDED SOLIDS YEARLY AVERAGE 96.2%

BOD YEARLY AVERAGE 92.9%

	JAN	FEB	MAR	APR	MAY	JUN	JUL	AUG	SEP	OCT	NOV	DEC
TSS	95.9	94.5	94.2	94.9	96.8	96.1	96.1	96.1	97.5	97.4	98.1	96.5
BOD	93.6	90.3	89.8	88.6	91.9	93.8	95.0	93.3	95.6	94.1	95.1	93.3

SECTION II

DEWATERED SLUDGE

CITY OF CRESCENT CITY - SUMMARY OF TREATMENT REPORT
DISCHARGE MONITORING, NPDES PERMIT NO. CA0022756
2019 Annual Report

DEWATERED SLUDGE - BELT PRESS OPERATION										DIGESTER OPERATION		
MONTH	GALLONS PRESS FEED	DRY TONS REMOVED	AVG % SOLIDS CAKE	DAYS RUN	BAGS OF POLYMER USED	AVG. % SOLIDS RAW	RAW-DIG#2	RAW-DIG#1	AVG % VOLATILE REDUCTION	AVG % VOLATILE REDUCTION		
JAN	215,380	10.9	15.7	18	2	4.3	58.8		49.79			
FEB	196,791	9.3	15.8	17	4	4.4	42.9		42.44			
MAR	205,780	9.5	16.0	21	6	4.7	59.1		46.68			
APR	202,326	10.7	15.1	16	6	4.5	53.4		48.09			
MAY	213,097	10.4	15.2	18	3	4.2	63.3		53.06			
JUN	211,201	11.0	14.7	18		3.7	62.8		56.3			
JUL	337,433	14.2	15.4	20	3	2.8	58.5		50.93			
AUG	364,956	14.7	17.4	17		2.5	48.8		50.52			
SEP	282,633	12.2	15.4	18	1	4.3	54.3		54.51			
OCT	196,940	10.7	15.1	15		4.9	66.2		58.38			
NOV	210,076	8.5	15.3	14	3	5.2	60.0		55.69			
DEC	193,970	12.9	15.6	14	4	6.5	49.5		39.8			
TOTAL	2,830,583	135.0		206	32							
AVG	235,882	11.3	15.6	17	4	4.3	56.5		50.5			
MIN	193,970	8.5	14.7	14	1	2.5	42.9		39.8			
MAX	364,956	14.7	17.4	21	6	6.5	66.2		58.4			

Dewatered Sludge is taken to Dry Creek Landfill at White City, Oregon

March 1, 2021

Regional Water Quality Control Board
North Coast Region
5550 Skylane Boulevard, Suite A
Santa Rosa, CA 95403

Attention: Cathy Goodwin

RE: NPDES CA0022756 – WDID 1A840060DN

Enclosed, please find the 2020 Annual Report for the City of Crescent City Water Pollution Control Facility, located at 210 Battery Street, WDID Number 1A840060DN, as required under NPDES Permit Number CA0022756.

In 2020, the following exceedances of effluent limits occurred:

- Daily total residual chlorine on 1/16/20, 1/17/20, 2/3/20, 05/15/20, 05/31/20, 07/26/20, 10/4/20, 12/14/20
- Daily settleable solids on 4/4/20
- Monthly fecal coliform for July and October

In 2020, the following exceedances for receiving water limits occurred:

- Daily enterococcus on 4/27/20, 11/16/20, 11/17/20, 12/14/20, 12/28/20

Sanitary Sewer Overflows are detailed in Attachment 6.

Regarding the permit Special Provision Requirements, key activities included:

- A Local Limits Evaluation Report was submitted prior to July 1, 2020.
- Source Control and Pretreatment Studies, Updated Sewer Use Ordinance. These will be submitted prior to July 1, 2021
- On September 21st, 2020 the City awarded Stover Engineering a contract to prepare a Climate Change Readiness Study Plan which is nearing completion and will be delivered prior to April 1st, 2021.
- Financial Plan submitted in 2018
- Completed the Outfall Inspection and Evaluation Report (April 2020 submitted on CIWQS)
- The Biological Survey of outfall Final Report is in progress and will be submitted prior to April 1st, 2021.
- Submitted the annual DMR-QA Study (submitted to SWRCB Quality Assurance Program, September 2020)

- Pollutant Minimization Program. City is not aware of any evidence that a toxic pollutant is present in the effluent at a concentration greater than an applicable effluent limitation.

In addition to the above submittals, the City completed the following tasks.

- Uploaded Q4 2020 PFAS sample results to the GeoTracker Website (December 2020 submitted)
- Submitted the PFAS Questionnaire to the GeoTracker website (January 2021 submitted)
- Submitted the 2020 Annual Biosolids Report to the USEPA Central Data Exchange website (submitted February 2021)

In 2019 the City solicited proposals from contract operations firms to operate and manage the Crescent City Wastewater Treatment Facility. Operations Management International, Inc (OMI), a member of the Jacobs Engineering Group took over responsibility for operations and maintenance on September 9, 2019. OMI's contract term is from September 9, 2019 through June 30, 2025.

Jacobs Engineering staff include certified Grade V, Grade IV, Grade III, and Grade 1 operators as well as an Operator-in-Training and a plant mechanic.

Plant maintenance is recorded on a computer maintenance management system and operations activities are recorded daily in a treatment plant logbook.

There were a number of major equipment repair and replacement activities that took place in 2020. It should be noted that there weren't any equipment issues that were critical in nature that would have been considered an emergency. The following list summarizes major maintenance items attended to in 2020:

1. Replaced influent, primary and effluent composite samplers
2. Belt press improvements. Replaced drive motor for the belt system
3. Capital improvement project completed. Containment drains were added to site entrances, including underground piping tied to the plant headworks.
4. Replaced digester 1 recirculation pump gear box and motor.
5. Rebuilt Digester 1 recirculation pump
6. Repaired an underground sludge line
7. Rebuilt the Rotary Drum Thickener sludge pump
8. Repaired a filtrate carrier water pump
9. Replaced a section of carrier water piping
10. Rebuilt one of two SBS pumps
11. Calibrated SBS and CL₂ pumps to match lead/lag pump outputs

12. Changed Motors and belts on CL₂ pumps
13. Adjusted SBS and CL₂ drive belt settings to optimize chemical rate with effluent flow
14. Rebuilt a secondary clarifier sludge pump
15. Rebuilt both primary clarifier grit pumps
16. Rebuilt the gear box on the primary skimming pump
17. Replaced the Rotary Drum Thickener enclosure seals
18. Replaced an MBR filtrate pump motor
19. Replaced an MBR air scour valve

I certify under penalty of law that this document and all attachments were prepared under my direction and supervision in accordance with a system designed to assure that qualified personnel properly gather and evaluate the information submitted. Based on my inquiry of the person or persons who manage the system, or those persons directly responsible for gathering the information, the information submitted is, to the best of my knowledge and belief, true, accurate, and complete. I am aware that there are significant penalties for submitting false information, including the possibility of fine and imprisonment for knowing violations. [40 CFR, section 122.22 (d)].

If you have any questions about this annual report, please contact me at (707) 465-3129.

Regards,



Jonathan Olson, PE
City Engineer/LRO
City of Crescent City
Water Pollution Control Facility

Item 1- Where appropriate, tabular, and /or graphical summaries of the monitoring data and disposal records from the previous year. If the Permittee monitors any pollutant more frequently than required by this Order, using test procedures approved under 40 CFR part 136 or as specified in this Order, the results of this monitoring shall be included in the calculation and report submitted by SMR.

Results are included as Attachment # 1: Section I

Item 2- A comprehensive discussion of the Facility’s compliance (or lack thereof) with all effluent limitations and other WDRs, and the corrective actions taken or planned, which may be needed to bring discharge into full compliance with the Order.

Included as Attachment # 1: Section I

Item 3- The names and general responsibilities of all persons employed at the facility

Directory of WWTP personnel

Name	Grade	Title	Responsibilities
Dennis Burrell	V	Regional Manager	CPO/Supervisor. CPO from July 2019 until Feb 2020
Austin Nova	III	Operator	Daily operations and training
Xavier Knight	I	Operator in Training	Operator in Training
Richard M ^c Namara	OIT	OIT	Operator in training
David Martinez	III	Operator	Daily operations and training
David Zevely	IV	Project Manager	CPO starting Feb 2020, Project Manager, daily operations and training
Collin Sturdevant		Maintenance Mechanic	Plant equipment maintenance and repair

Item 4-The names and phone numbers of persons to contact regarding the Facility for emergency and routine situations.

OMI Staff		
	Business Hours	After Hours
David Zevely	707-465-3129	805-771-1886
Austin Nova	707-465-3129	707-954-0713

Dennis Burrell	707-465-3129	209-985-1071
City Staff		
Jon Olson	707-464-9506	707-951-3275
Eric Wier	707-464-9506	707-951-3016

Item 5- A statement clarifying when flow meter(s) and other monitoring instruments and devices were last calibrated, including identification of who performed the calibration.

Even though there are site and travel restrictions due to Covid-19 protocols, a technician from Jacobs regional support received travel permission to calibrate and evaluate both the influent and effluent flowmeters. The influent and effluent meters were evaluated and calibrated on February 3, 2021. The flowmeters' calibration extended beyond the annual meter verification, as both meters were last calibrated in October 2019. However, both flowmeters passed the calibrations and the actual flow meter read outs were verified by using water level measurements and the equipment standardized flow data sheets. No changes were necessary and both meters remained accurate and didn't drift since the last calibration. Final effluent chlorine dose and residual analyzers are calibrated in-house, as needed and typically on a weekly basis.

Item 6- Sludge Handling and Disposal Activity Reporting. The permittee shall submit, as part of its annual report to the Regional Water Board, a description of the Permittee's solids handling, disposal, and reuse activities over the previous 12 months. At a minimum the report shall contain:

- i. Annual sludge production, in dry tons and percent solids

142 Dry tons of sewage sludge at 15.7 % solids were generated in 2020.

- ii. Sludge monitoring results

Tabular results are included in Attachment #1: Section II and solids lab results are included as attachment 3

- iii. A schematic diagram showing sludge handling facilities (e.g., digesters, thickeners, drying beds, etc.), if any and a solids flow diagram.

See Plant Diagram included as Attachment #2

- iv. Methods of final disposal of sludge

Sludge is disposed at White City Oregon Landfill, a Municipal Landfill Under 40 CFR 258.

Item 7- Storm water Reporting

The City's Wastewater Treatment Facility does not require a stormwater permit because onsite stormwater runoff drains to the headworks. The City completed an onsite water management improvement by installing trench drains and other drainage improvements around the site to further minimize risk. The drainage improvements project was completed in April 2020.

Item 8-septage Monitoring and Reporting

City of Crescent City is currently not approved for Septage Monitoring and Reporting, so there is no monitoring and reporting information.

Item 8-DMR-QA Study Report. The Permittee shall submit, as part of its annual report to the Regional Water Quality Control Board, an electronic copy of the annual DMR-QA study report submitted to the State Water Board, Quality Assurance Program officer pursuant to Section I.F of the MRP.

Included as Attachment # 4 are the DMR-QA results.

Item 9- Annual Pretreatment Reporting Requirements. The permittee shall submit annually.

The Annual Pretreatment Report is included as Attachment # 5.

Attachment #1:

**WWTP Graphical
Summary**

CRESCENT CITY
WASTEWATER TREATMENT PLANT
2020 Graphical Summary

SECTION I

WWTP SUMMARY

SECTION II

DEWATERED SLUDGE

SECTION I

SECTION I
WWTP SUMMARY REPORT

CITY OF CRESCENT CITY - SUMMARY OF TREATMENT
DISCHARGE MONITORING - NPDES PERMIT NO. CA0022756
2020 ANNUAL REPORT

Month	Flow MGD Avg	PH	TOTAL CL2 mg/L	SETTLEABLE SOLIDS EFF	SUSPENDED SOLIDS			BOD5			FECAL MPN MEDIAN	GREASE AND OIL	TURBID- ITY	MONTH TOTAL RAINFALL IN
					INF	EFF	LBS/DAY	INF	EFF	LBS/DAY				
Jan	2.280	7.30	0.16	0.09	135.0	8.54	164	152.0	18.6	344	3.25	ND<5.5	6.4	15.02
Feb	1.540	7.34	<0.05	0.12	163.0	7.8	95	185.0	20.9	254	7.8	ND<4.9	8.9	1.86
Mar	1.050	7.35	<0.05	0.18	225	8.8	74	248.0	19.0	162	12	ND<4.9	7.1	3.72
Apr	1.070	7.31	0.3	0.245	197	9.8	87	230	15.6	137	4.5	nd<5.2	5.53	3.13
May	1.07	7.31	<0.05	0.119	189	8.8	80.5	207	14.1	128	7.8	nd<4.8	5.7	6.65
Jun	0.94	7.29	<0.05	0.117	200	9.0	70.4	239	12.2	95	4.5	nd<4.6	5.0	0.92
Jul	0.83	7.29	<0.05	0.22	250	9.76	67.1	284	14.5	99	7.8	nd<5	4.72	0.03
Aug	0.78	7.34	<0.05	0.155	338	14.6	93.2	353	18	115	4.1	nd<5.1	5.2	0.10
Sep	0.780	7.37	<0.05	0.167	363	11.8	75.9	362	15.1	97.7	1.9	nd<4.9	4.19	1
Oct	0.743	7.35	<0.05	0.126	305.6	10.4	63.4	303.2	12.2	74.4	17	nd<5.1	3.9	1.25
Nov	0.769	7.32	<0.05	0.113	309.15	9.7	62.5	297.18	9.98	63	4.5	nd<5.0	3.2	5.77
Dec	0.991	7.38	<0.05	0.106	294.4	9.7	84	276.1	13.2	114	4.5	nd<6.3	5.06	8.87
TOTAL	12.843													48.32
AVG	1.070	7.33	0.08	0.147	247	9.9	85	261	15.3	140	6.6	<5.54	5.4	4.03
MIN	0.743	7.29	<0.05	0.090	135	7.8	63	152	9.98	63	2	<4.6	3.2	0.03
MAX	2.280	7.38	0.30	0.245	363	14.6	164	362	20.9	344	17	<6.3	8.9	15.02

DISCHARGE LIMITS; Ph limits 6.0 min to 9.0 max

6 MONTH MEDIAN	0.06													
30 DAY AVG		1			30	465			30	465	14	25	75	
7 DAY AVG		1.5			45	700			45	700		40	100	
INSTANTANEOUS MAX	1.8	3										75	225	
1 DAY MAX	0.24										43			

CITY OF CRESCENT CITY - SUMMARY OF TREATMENT
EFF DISCHARGE MONITORING - NPDES PERMIT NO.CA0022756
EFFLUENT 2020 ANNUAL REPORT

MONTH	FLOW	CALCULATED		VIOLATIONS						
	MGD	TSS%	BOD%							
	TOTAL	REMOVAL	REMOVAL	EFFLUENT				# OF TESTS RUN	% MONTHLY VIOL	% DAILY VIOL
				PARAMETER	MONTHLY	WEEKLY	DAILY			
JAN	70.670	93.7	87.8	pH	0	0	0	366	0	0.00
FEB	44.560	95.2	88.7	CL2 RES	0	0	4	386	0	1.04
MAR	32.560	96.1	92.3	SET SOLIDS	0	0	1	374	0	0.27
APR	32.030	95.0	93.2	TSS EFF mg/L	0	0	0	154	0	0.00
MAY	33.29	95.4	93.2	TSS #/DAY	0	0	0	154	0	0.00
JUN	28.17	95.5	94.9	BOD EFF mg/L	0	0	0	153	0	0.00
JUL	25.67	96.1	94.9	BOD #/DAY	0	0	0	153	0	0.00
AUG	24.22	95.9	95.6	FECAL COLI	3	0	0	160	25	0.00
SEP	23.290	96.8	95.8	GREASE & OIL	0	0	0	12	0	0.00
OCT	23.030	96.6	96.0	TURBIDITY	0	0	0	366	0	0.00
NOV	23.080	96.9	96.6	TOTAL VIOLATIONS	3	0	5	2278		
DEC	30.708	96.69	95.2	RSW LIGHTHOUSE						
TOTAL	391.28			RSW ENTERO	0	N/A	5	58	0	8.62
AVG	32.61	95.8	93.7	RSW TOTAL COLI	0	N/A	0	52	0	0.00
MIN	23.03	93.68	87.79	RSW FECAL COLI	0	N/A	0	52	0	0.00
MAX	70.67	96.86	96.6	TOTAL VIOLATIONS	0	N/A	5	162		

2020 DAILY PLANT FLOW EFF

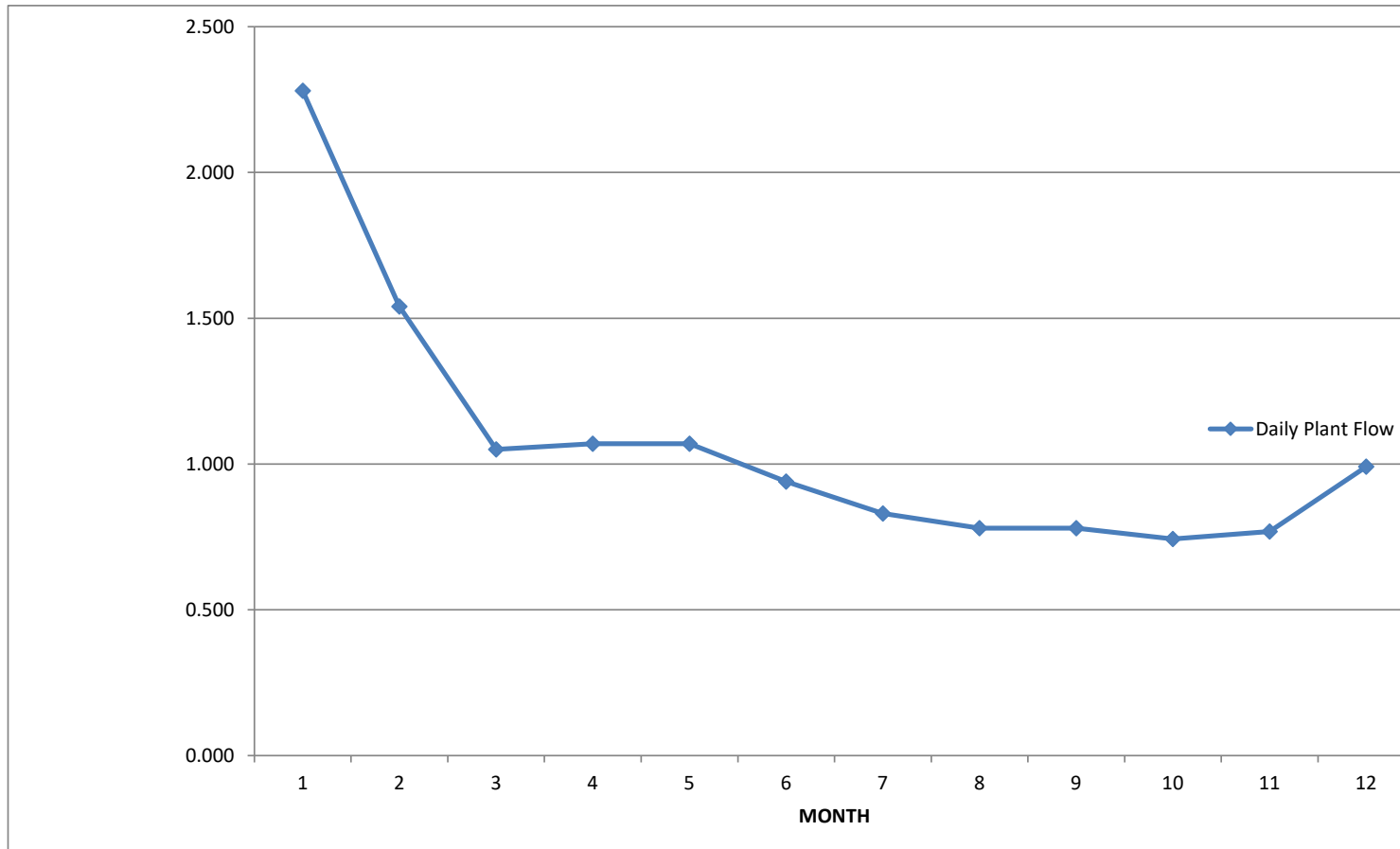

DAILY AVERAGE FLOW MILLION GALLONS

	JAN	FEB	MAR	APR	MAY	JUN	JUL	AUG	SEP	OCT	NOV	DEC
AVG	2.280	1.540	1.05	1.070	1.07	0.94	0.83	0.78	0.780	0.743	0.769	0.991
MIN	1.400	1.140	0.9	0.900	0.890	0.85	0.7	0.740	0.71	0.614	0.613	0.699
MAX	3.7	2.31	1.24	1.67	1.38	1.08	0.92	0.86	0.860	0.914	1.16	1.459

2020 EFFLUENT FLOW AND RAINFALL

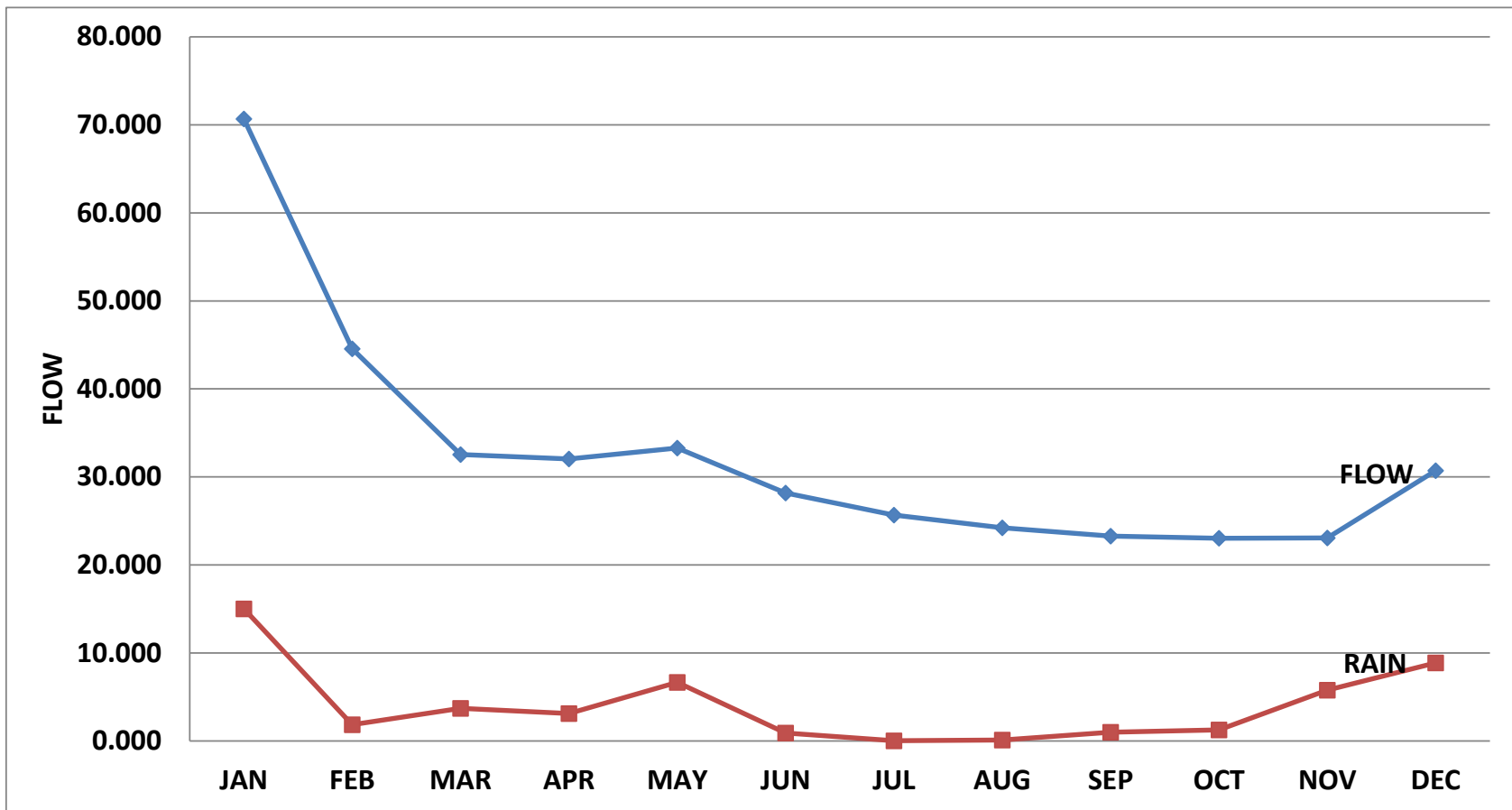

FLOW TOTAL 391.3 MILLION GALLONS
MONTHLY AVERAGE 32.6 MILLION GALLONS

RAINFALL ANNUAL TOTAL 48.32 INCHES
MONTHLY AVERAGE 4.03 INCHES

	JAN	FEB	MAR	APR	MAY	JUN	JUL	AUG	SEP	OCT	NOV	DEC
FLOW	70.67	44.56	32.56	32.03	33.29	28.17	25.67	24.22	23.29	23.03	23.08	30.71
RAINFALL	15.02	1.86	3.72	3.13	6.65	0.92	0.03	0.10	1	1.25	5.77	8.87

2020 EFFLUENT S/S & BOD

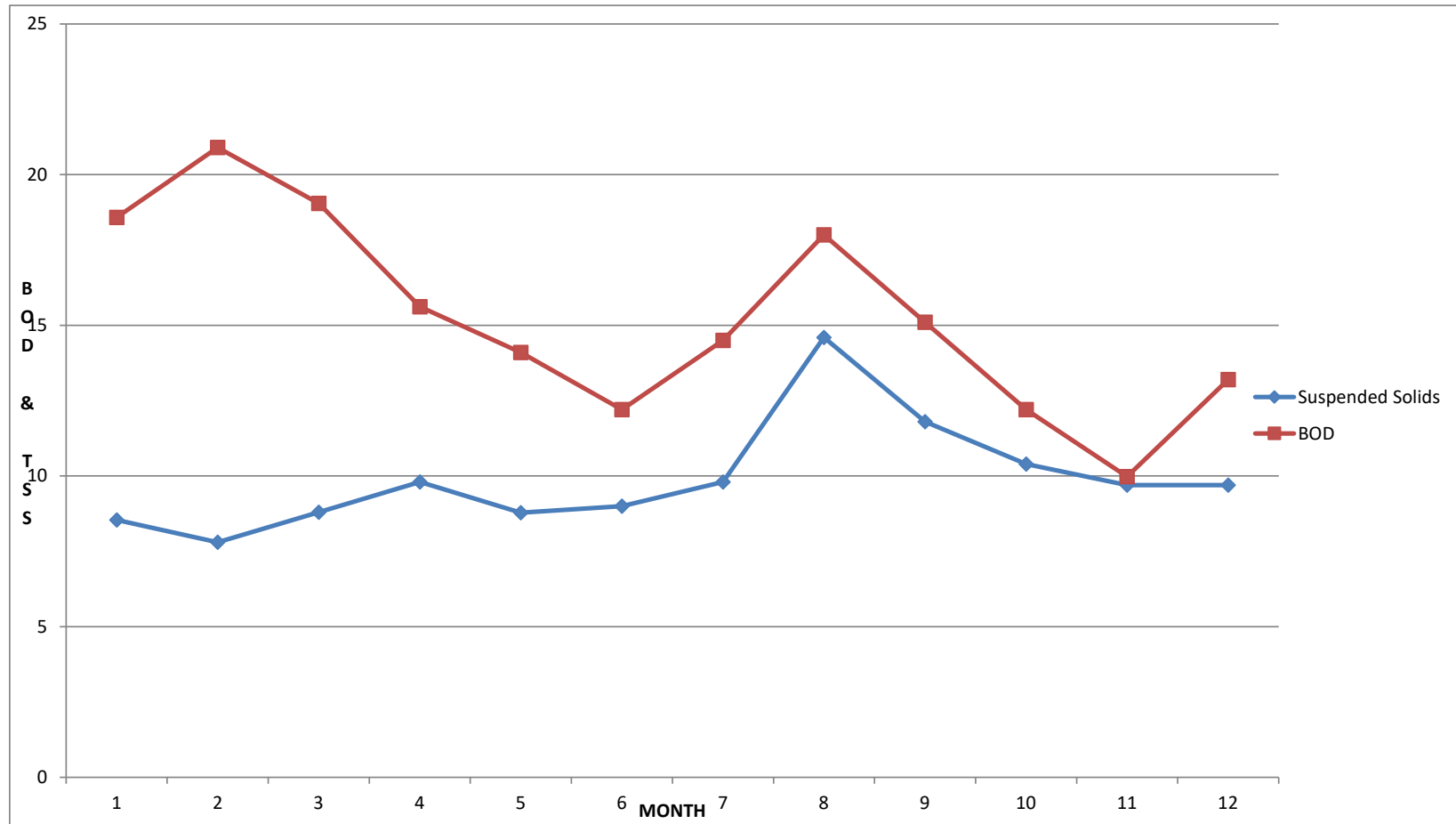

LIMIT 30 mg/L
 SUSPENDED SOLIDS YEARLY AVERAGE = 9.9 mg/L
 BOD YEARLY AVERAGE = 15.3 mg/L

	JAN	FEB	MAR	APR	MAY	JUN	JUL	AUG	SEP	OCT	NOV	DEC
S.S.	8.54	7.8	8.8	9.8	8.8	9.0	9.8	14.6	11.8	10.4	9.7	9.7
BOD	18.58	20.9	19.05	15.62	14.1	12.2	14.49	18	15.12	12.2	9.98	13.2
FLOW	2.280	1.54	1.05	1.07	1.07	0.94	0.83	0.78	0.780	0.743	0.77	0.991
BOD LBS/Day	344.0	254.0	162.0	136.7	128.0	95.2	98.6	115.0	97.7	74.4	63.0	113.8

2020 EFFLUENT SUSPENDED SOLIDS & BOD, Lbs/day, Monthly Average

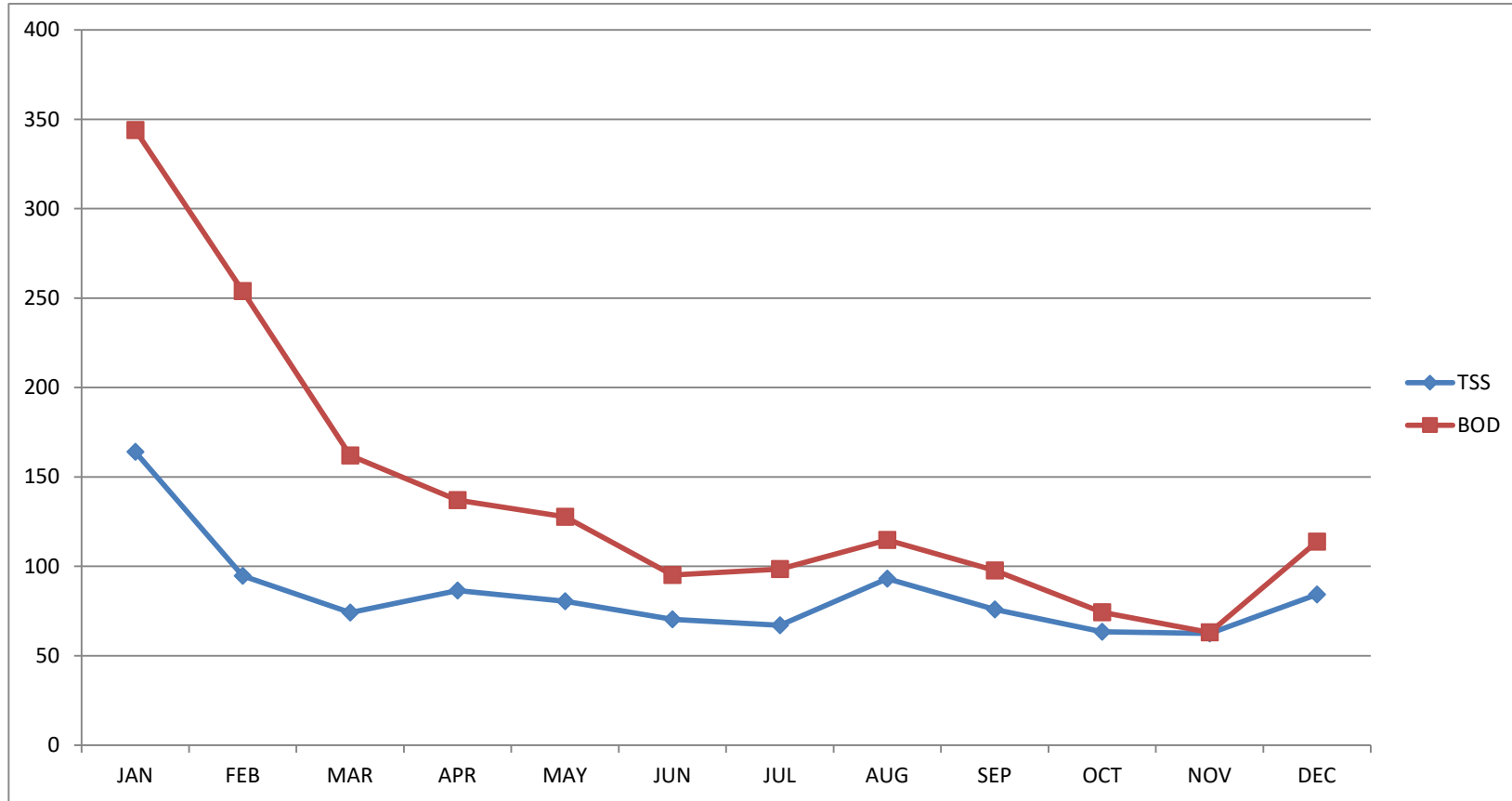

LOADING LIMITS; Weekly AVG BOD 700 lbs/Day, AVG SS 465 lbs/Day
 YEARLY AVG SUSPENDED SOLIDS = 85 lbs/day
 YEARLY AVG BOD = 140 lbs/day

	JAN	FEB	MAR	APR	MAY	JUN	JUL	AUG	SEP	OCT	NOV	DEC
TSS	164	94.63	74.1	86.48	80.52	70.35	67.08	93.18	75.85	63.4	62.5	84.3
BOD	344	254	162	137	127.7	95.2	98.56	114.69	97.72	74.4	63.03	113.8

2020 FECAL COLIFORM

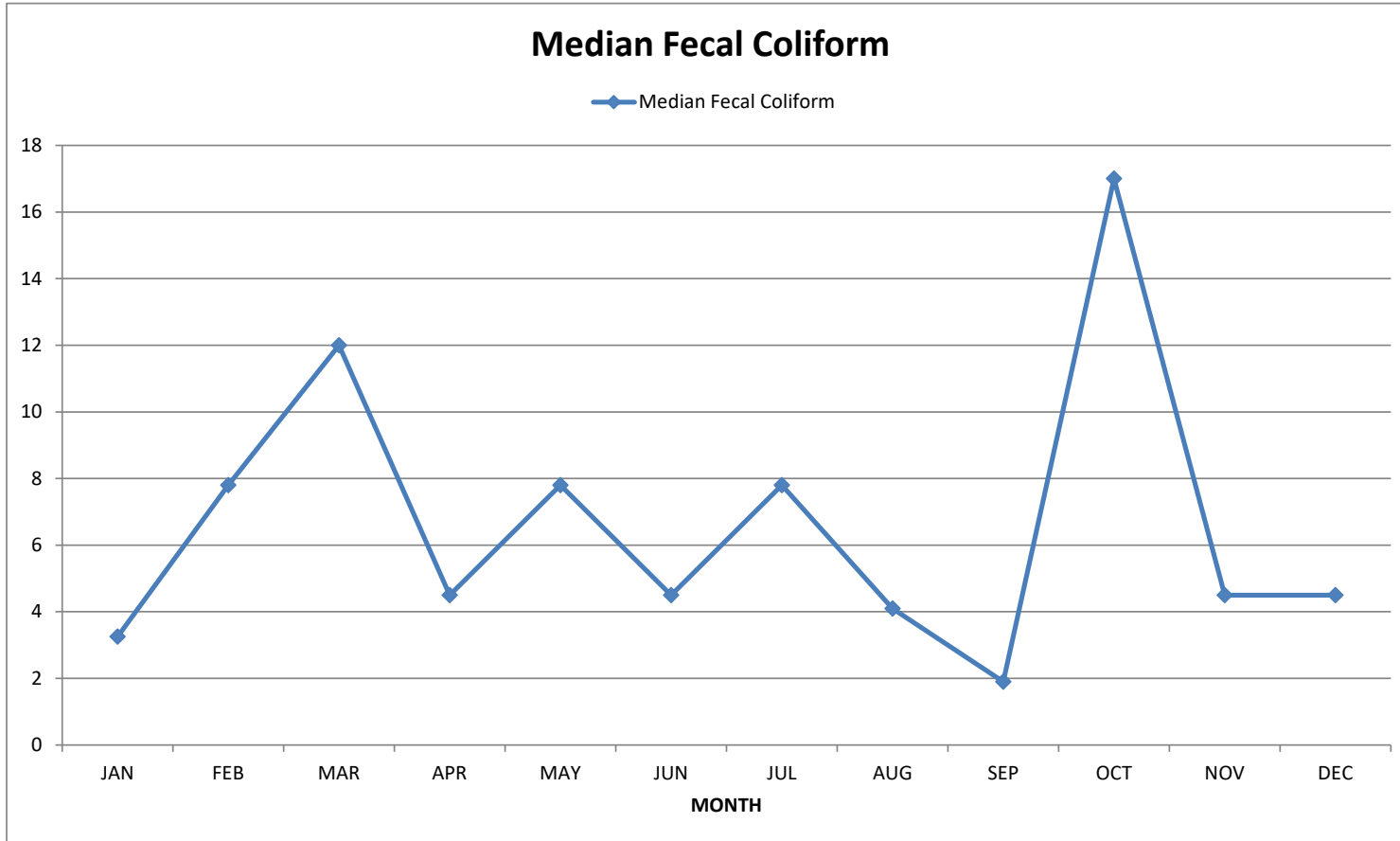

LIMIT 10% GREATER THAN 43 PER MONTH

LIMIT 14 MPN MONTHLY MEDIAN

LIMIT 400 MPN PER DAY

MEDIAN YEARLY AVERAGE = 6.6

MONTHS IN MEDIAN VIOLATION = 1

MONTHS IN MEDIAN VIOLATION = 8.33%

DAYS IN VIOLATION = 0

MONTHS IN VIOLATION GREATER THAN 10% OVER 43 = 2

MONTHS IN VIOLATION 10% OVER 43= 16.67%

FECAL COLIFORM	JAN	FEB	MAR	APR	MAY	JUN	JUL	AUG	SEP	OCT	NOV	DEC
	3.25	7.8	12	4.5	7.8	4.5	7.8	4.1	1.9	17	4.5	4.5

2020 GREASE & OIL, TURBIDITY

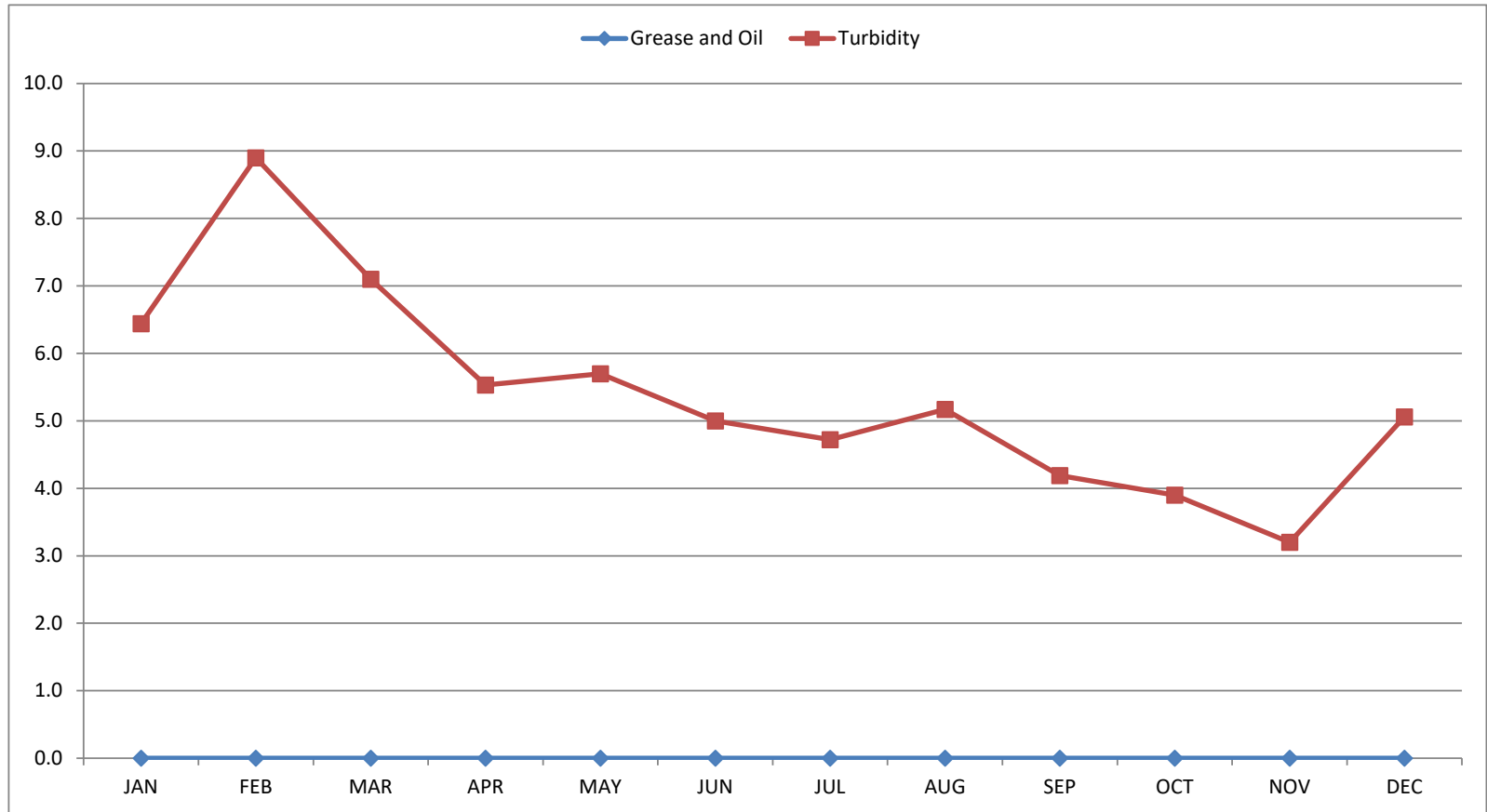

LIMITS; GREASE & OIL - 25mg/L, TURBIDITY - 75 NTU

GREASE & OIL YEARLY AVERAGE <5.54mg/L

TURBIDITY YEARLY AVERAGE 5.4 NTU

	JAN	FEB	MAR	APR	MAY	JUN	JUL	AUG	SEP	OCT	NOV	DEC
GREASE & OIL	<5.5	<4.9	<4.9	<5.2	<4.8	<4.6	<5	<5.1	<4.9	<5.1	<5.0	<6.3
TURBIDITY	6.4	8.9	7.1	5.53	5.7	5.0	4.72	5.17	4.19	3.9	3.2	5.1

WWTP BOD/TSS % REDUCTION For 2020

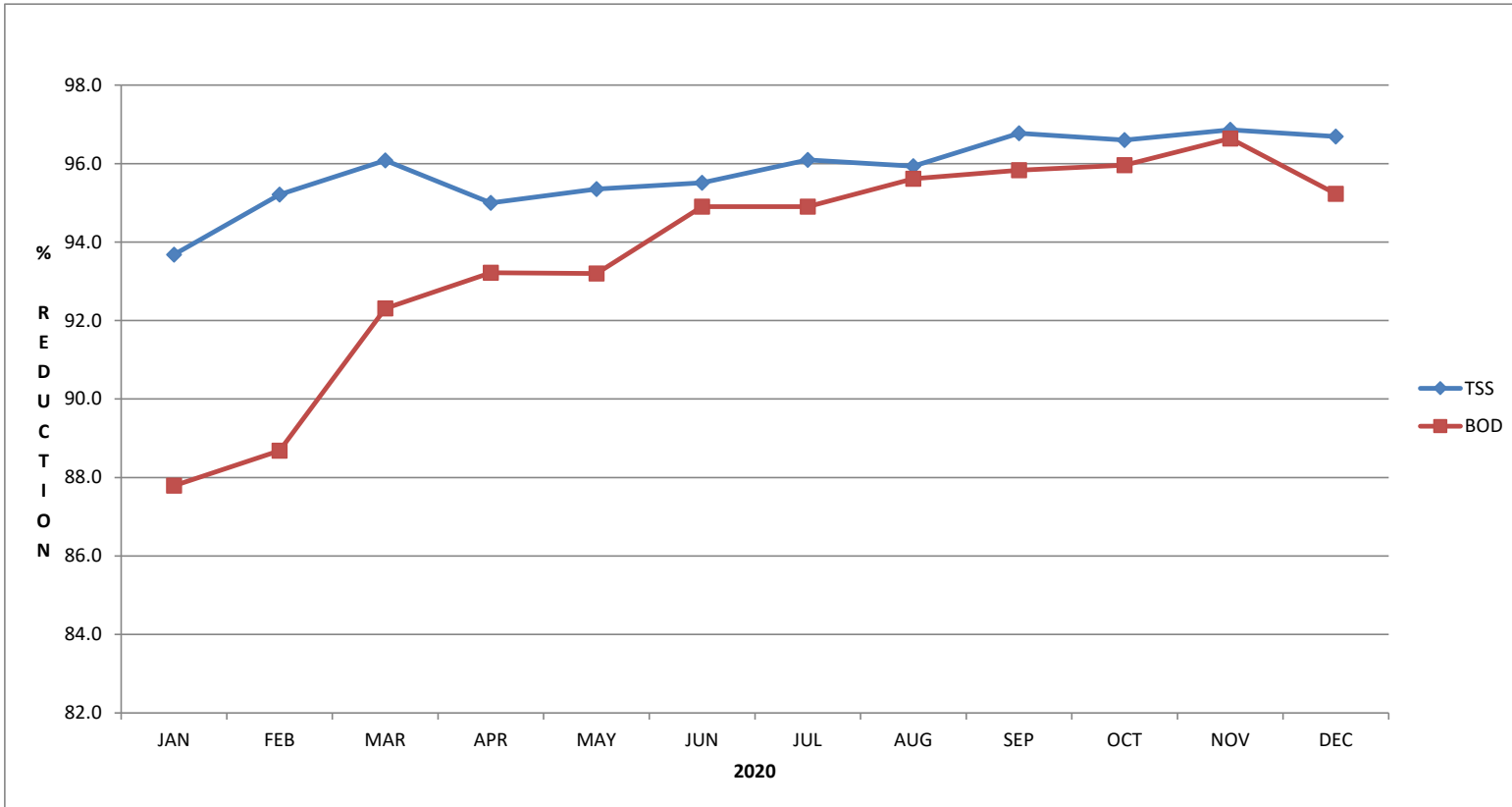

SUSPENDED SOLIDS YEARLY AVERAGE 95.8%

BOD YEARLY AVERAGE 93.7%

	JAN	FEB	MAR	APR	MAY	JUN	JUL	AUG	SEP	OCT	NOV	DEC
TSS	93.7	95.2	96.1	95.0	95.4	95.5	96.1	95.9	96.8	96.6	96.9	96.7
BOD	87.8	88.7	92.3	93.2	93.2	94.9	94.9	95.6	95.8	96.0	96.6	95.2

2020 INFLUENT SUSPENDED SOLIDS & BOD

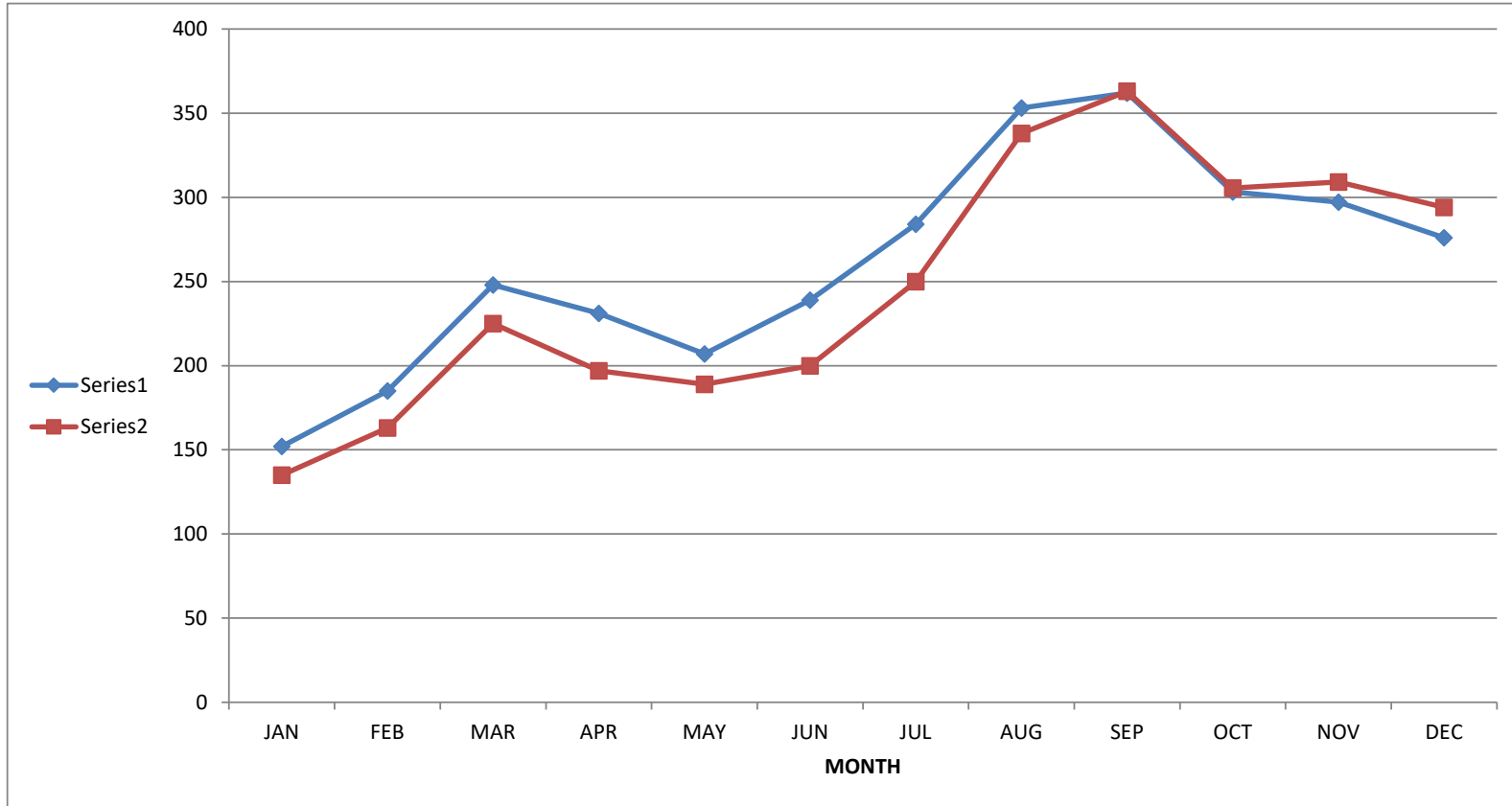

SUSPENDED SOLIDS YEARLY AVERAGE 247 mg/L
 SUSPENDED SOLIDS YEARLY AVERAGE 2492 lbs/day
 BOD YEARLY AVERAGE 261 mg/L
 BOD YEARLY AVERAGE 2655 lbs/day

	JAN	FEB	MAR	APR	MAY	JUN	JUL	AUG	SEP	OCT	NOV	DEC
TSS	135	163	225	197	189	200	250	338	363	305.6	309.15	294
BOD	152	185	248	231	207	239	284	353	362	303.2	297.18	276
Inf Flow	2.44	1.74	1.25	1.28	1.28	1.16	1.08	1.03	0.97	0.958	1.04	1.253
TSS lb/day	2747	2365	2346	2103	2018	1935	2252	2903	2937	2442	2681	3072
BOD lb/day	3093	2685	2585	2466	2210	2312	2558	3032	2929	2422	2578	2884

Appendix C:

Outfall Inspection

CITY OF CRESCENT CITY
WASTEWATER REATMENT FACILITY OUTFALL
INSPECTION / EVALUATION REPORT



Prepared by:

City of Crescent City
377 J Street
Crescent City, CA 95531

March 2019

TABLE OF CONTENTS

TABLE OF CONTENTS	i
LIST OF FIGURES	ii
LIST OF APPENDICES	iii
LIST OF VIDEO ATTACHMENTS	iv
1.0 INTRODUCTION	1
1.1 Deviations from the Workplan	1
2.0 EXTERNAL INSPECTION	3
2.1 Exposed Portions of the Outfall	3
2.2 Major Elements	5
2.3 Minor Elements	7
3.0 INTERNAL INSPECTION	8
3.1 24-Inch DIP/HDPE Outfall Line	8
3.2 18/12-Inch Outfall Line	8
3.3 20-Inch Outfall Line from Pressure Vessel	8
4.0 RECORDS REVIEW	9
4.1 Outfall Pumps (Stormwater Pumps)	9
5.0 CONCLUSIONS	10
5.1 Outfall Maintenance	10
5.2 Inspection Frequency and Focus	10
6.0 REFERENCES	11

LIST OF FIGURES

FIGURE 1 ALIGNMENT OF OUTFALL LINES AND SIGNIFICANT
FEATURES

DRAFT

LIST OF APPENDICES

APPENDIX A	24-INCH OUTFALL INSPECTION REPORT
APPENDIX B	18-INCH OUTFALL INSPECTION REPORT
APPENDIX C	STORMWATER PUMP MAINTENANCE MANAGEMENT SYSTEM

DRAFT

LIST OF VIDEO ATTACHMENTS

VIDEO 1	24-INCH OUTFALL VIDEO
VIDEO 2	18-INCH OUTFALL VIDEO

DRAFT

1.0 INTRODUCTION

The outfall inspections documented in this report were conducted to meet the requirements of the Monitoring and Reporting Program included as part of Order No. R1-2017-0002 adopted by the North Coast Regional Water Quality Control Board (Regional Water Board) on February 2, 2017 including:

“The Permittee shall conduct a comprehensive evaluation/inspection of the outfall once during the term of the permit to verify the operational status and integrity of the outfall”.

The outfall inspections documented in this report were performed in general conformance with “City of Crescent City Wastewater Treatment Facility Outfall Inspection/Evaluation Work Plan,” dated March 13, 2018. The workplan was approved by the North Coast Regional Water Quality Control Board in a letter dated August 23, 2018.

Internal inspections were performed by ABC Plumbing on July 13, 2019 utilizing a remotely operated camera.

External inspections were conducted by City of Crescent City Staff on October 22, 2019 and February 21, 2020.

1.1 Deviations from the Workplan

The pressure vessel (Feature 3 in Figure 1) was only inspected externally. ABC Plumbing was not able to drive their truck on the beach to insert the camera in the pressure vessel. The 20-inch outfall from the pressure vessel was not inspected.

DRAFT

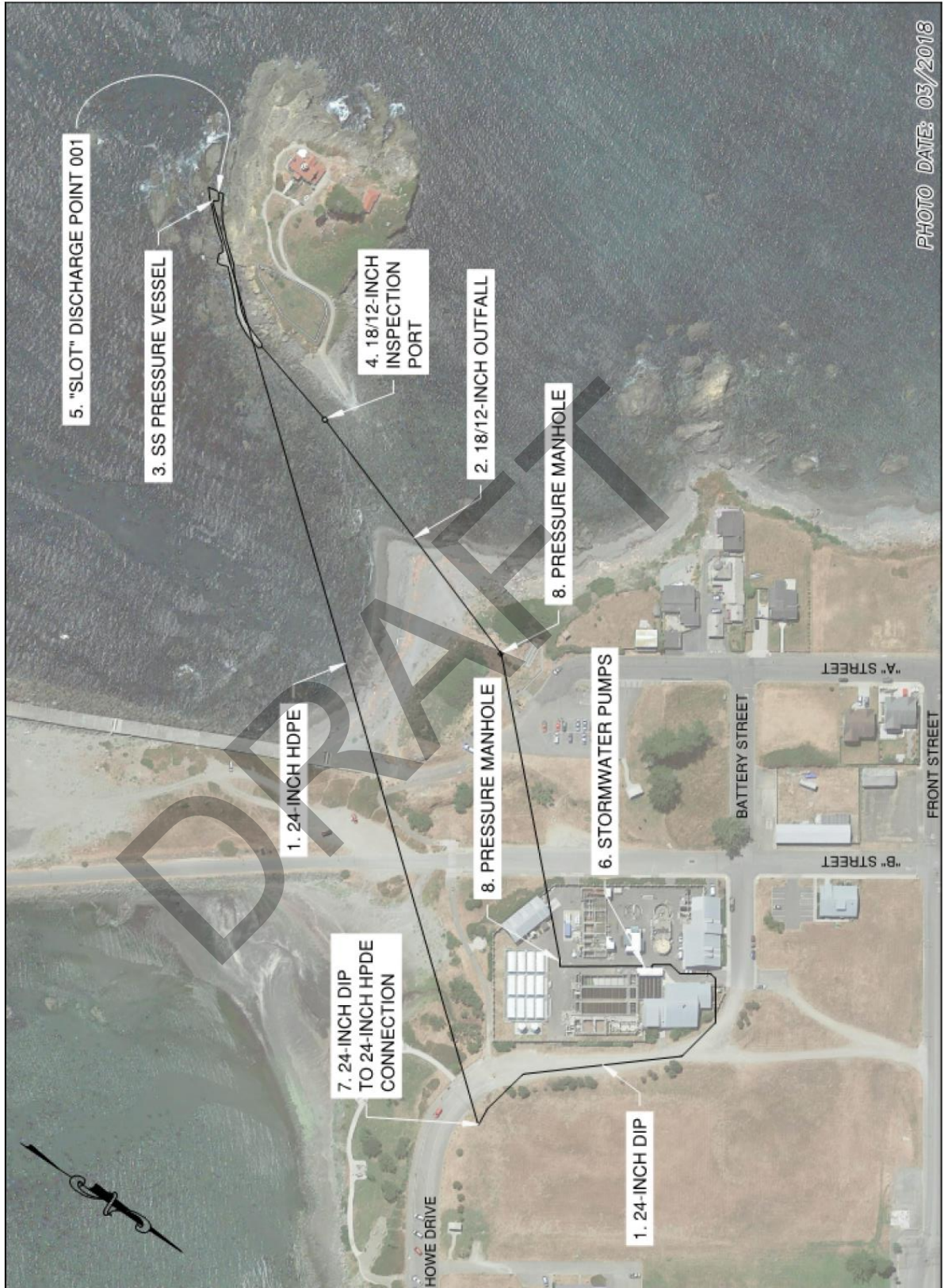

FIGURE 1. ALIGNMENT OF OUTFALL LINES AND SIGNIFICANT FEATURES

2.0 EXTERNAL INSPECTION

2.1 Exposed Portions of the Outfall

City Staff inspected and took new photos of the exposed portions of the outfall. The numbers in the photograph descriptions correlate to numbered features on the map included as Figure 1.



Feature 2, Concrete cover over 18/12-inch outfall. Concrete cover is in good condition.



Feature 2, Concrete cover over 18/12-inch outfall. Concrete cover is in good condition.



Feature 3, Stainless steel pressure vessel in good condition.



Feature 4, 18/12-inch inspection port, missing 4 bolts.



Feature 5, "Slot" discharge point 001, condition not directly observed.



Feature 8, Gravity manhole in good condition.

2.2 Major Elements

City Staff performed external inspections of the major components of the outfall as indicated in the sections below:

24-inch DIP/HDPE outfall line

Date of inspection	October 22, 2019
General Condition	Good
Damage	None visible
Corrosion	None visible

18/12-inch outfall line

Date of inspection	October 22, 2019
General Condition	Good
Damage	None visible
Corrosion	Acceptable

Stainless steel pressure vessel

Date of inspection	October 21, 2019
General Condition	Excellent
Damage	N/A
Corrosion	None

18/12-inch inspection port

Date of inspection	October 21, 2019
General Condition	Good, missing 4 bolts
Damage	None visible
Corrosion	Acceptable
Portions of the exposed pipe	Minor visible damage

Portion of 18/12-inch covered in grout and exposed in the tidelands

Date of inspection	October 21, 2019
General Condition	Good
Damage	None visible
Corrosion	Acceptable
Portions of the exposed pipe	Minor visible damage

Discharge slot and pipe (low tide inspection from above)

Date of inspection	October 21, 2019
General Condition	Good
Damage	Not visible
Corrosion	None

Storm water Pumps

Discussed in Section 4.2 of this report

24-inch HDPE to DIP connection

Date of inspection	October 22, 2019
General Condition	Excellent
Damage	N/A
Corrosion	None

18/12-inch Pressure manholes

Date of inspection	October 21, 2019
General Condition	Excellent
Damage	N/A
Corrosion	None

2.3 Minor Elements

Small vent on Battery Point

Date of inspection	October 21, 2019
General Condition	Missing but still functioning
Damage	Yes
Clear of obstructions	Yes

Small vent on Battery Point (bird screen)

Date of inspection	October 21, 2019
General Condition	Missing but still functioning
Damage	Missing
Clear of obstructions	N/A

Small vent on Battery Point below elbow (remove elbow)

Date of inspection	October 21, 2019
General Condition	Missing
Damage	Missing
Clear of obstructions	N/A

DRAFT

3.0 INTERNAL INSPECTION

3.1 24-Inch DIP/HDPE Outfall Line

The primary outfall line, constructed in 2006, consists of approximately 600-feet of 24-inch ductile iron pipe and 1,500-feet of 24-inch HDPE pipe.

Internal inspection video “24-inch Outfall Video” (Video Attachment 1) is within the 24-inch outfall line from Howe Drive (Feature 7 in Figure 1) 986 feet downstream toward the pressure vessel (Feature 3 in Figure 1). A summary of the inspection is attached as Appendix A.

The video file is contained on the attached DVD and is labeled “24-inch Outfall Video” (Video Attachment 1).

The video was taken entirely below the water level in the pipe and quality and details are poor. Upon review, there were no obvious accumulations of sediment or debris.

3.2 18/12-Inch Outfall Line

The older parallel line is composed of two parts; approximately 600-feet of 18-inch ductile iron pipe (DIP) constructed in 1977 and approximately 700-feet 12-inch cast iron pipe constructed in 1957.

Internal inspection video “18-inch Outfall Video” (Video Attachment 2) is within the 18-inch DIP from Gravity Manhole (Feature 8 in Figure 1) 498.7 feet upstream toward the WWTP. A summary of the inspection is attached as Appendix B.

The video file is contained on the attached DVD and is labeled “18-inch Outfall Video” (Video Attachment 2).

The video was taken partially below the water level in the pipe and quality and details are poor. Upon review, there were no obvious accumulations of sediment or debris.

3.3 20-Inch Outfall Line from Pressure Vessel

The two effluent lines come together adjacent to the discharge point in a stainless-steel pressure vessel. From the pressure vessel, a 20-inch ductile iron pipe is sloped downward and discharges into a rocky slot in the surf zone adjacent to Battery Point Lighthouse.

The pressure vessel (Feature 3 in Figure 1) was only inspected externally. ABC Plumbing was not able to drive their truck on the beach to insert the camera in the pressure vessel. The 20-inch outfall from the pressure vessel was not inspected.

4.0 RECORDS REVIEW

4.1 Outfall Pumps (Stormwater Pumps)

Outfall Motor/Pump Maintenance History

There were no historical operational records discovered for outfall pump exercising, maintenance, or inspections, other than the attached September 2019 to present records. Since September 2019, the pumps are inspected monthly by a plant maintenance specialist. Outfall pump work orders are auto-generated through a maintenance management system (Appendix C):

- Monthly work order tasks include checks on
- operation of seal water,
- excessive leakage from packing area,
- check motor space heaters
- Oil level and bearing grease
- and unusual noise/vibration (to date, not conducted).
- Annual inspections include
- motor oil level check,
- bearing grease quality,
- clean cooling fins,
- and check for unusual noise, heat and vibration (to date, not conducted).

To prevent moisture accumulation on windings, space heaters on motors should be energized. As recently observed, the outfall pump motor heaters are energized.

The Jacobs' Maintenance mechanic contacted the motor and pump manufacturer to obtain factory operations and maintenance manuals to confirm the above maintenance practices.

There is no information about when the storm water pumps were last used.

On March 20, 2020, outfall pumps 1 and 2 were inspected and momentarily operated:

- Outfall Pump 1, after inspection, was momentarily operated and vibrated, made scraping noises, and struggled to turn. At this time, Pump 1 is out of service until additional evaluation and the problem is corrected.
- Outfall Pump 2 operated as expected, no vibrations or unusual noises.

5.0 CONCLUSIONS

5.1 Outfall Maintenance

Based on observations on the outfall inspection the following maintenance is recommended:

- New bolts for 18/12-inch inspection port; and
- Elbow and screen for small vent on Battery Point. While the vent at Battery Point is missing, we do not recommend replacing it as it was either vandalized or damaged by wave action. Where the vent pipe exists the rock, it is still functioning as a vent. Re-installation of the vent does not make sense as it is likely to be stolen or damaged again in the future. The missing vent does not appear to be affecting performance of the outfall.

5.2 Inspection Frequency and Focus

The recommended frequency of future inspections is once per 10 years. Future inspections should follow the same procedures as this current inspection.

DRAFT

6.0 REFERENCES

Stover Engineering, February 12, 2008, *“City of Crescent City Wastewater Treatment Facility Outfall Inspection/Evaluation Work Plan”*

DRAFT

APPENDIX A

24-INCH OUTFALL INSPECTION REPORT

DRAFT

Project Information 1

Surveyor Name	steve	Certificate Number	1434
Owner	CRESCENT CITY	Customer	
Drainage Area		PO Number	
Pipe Segment Reference		Date	7/13/2019 19:06
Street	HOWE	City	CRESCENT
Comments			

Manhole

Upstream MH	MH 1	Rim to Invert (U)	
Grade to Invert (U)		Rim to Grade (U)	
Downstream MH	OUT FALL	Rim to Invert (D)	
Grade to Invert (D)		Rim to Grade (D)	
Sewer Use		Direction of Survey	Downstream

Pipe

Height (Diameter)	24	Width	
Shape	Circular	Material	Polyethylene
Lining Method		Pipe Joint Length	
Total Length		Length Surveyed	986
Year Laid		Year Renewed	

Misc

Flow Control		Media Label	DVD
Purpose		Sewer Category	
Pre-Cleaning	No Pre-Cleaning	Date Cleaned	
Weather		Location Code	
Additional Info		Location Details	

Custom

Custom1	0	Custom2	0
Custom3	0	Custom4	0
Custom5	0	Custom6	
Custom7		Custom8	
Custom9		Video Location	

Project: CRESCENT

Date: 7/13/2019 7:06:00 PM

Street: HOWE

Length Surveyed: 986

Pacp Quick Overall Rating: 0000

Height (Diameter): 24

Street: HOWE

Pipe Segment Reference:

Upstream MH: MH 1

Downstream MH: OUT FALL

Direction of Survey: Downstream

Material: Polyethylene

Distance	Fault Observation	Time	Picture
0.0	<p align="center">Manhole Severity: None Remarks: MH 1</p>	35	
0.0	<p align="center">Water Level Severity: None Percent: 25</p>	52	
15.0	<p align="center">General Observation Severity: None Remarks: CAMERA SET</p>	03:30	

Distance	Fault Observation	Time	Picture
986.0	<p align="center">Manhole Severity: None Remarks: OUT FALL</p>	41:51	

Created with the  report generator

DRAFT

Project: CRESCENT

Date: 7/13/2019 7:06:00 PM

Street: HOWE

Length Surveyed: 986

Pacp Quick Overall Rating: 0000

Height (Diameter): 24

Street: HOWE

Pipe Segment Reference:

Upstream MH: MH 1

Downstream MH: OUT FALL

Direction of Survey: Downstream

Material: Polyethylene

Severity
Light
Moderate
Average
Heavy
Severe

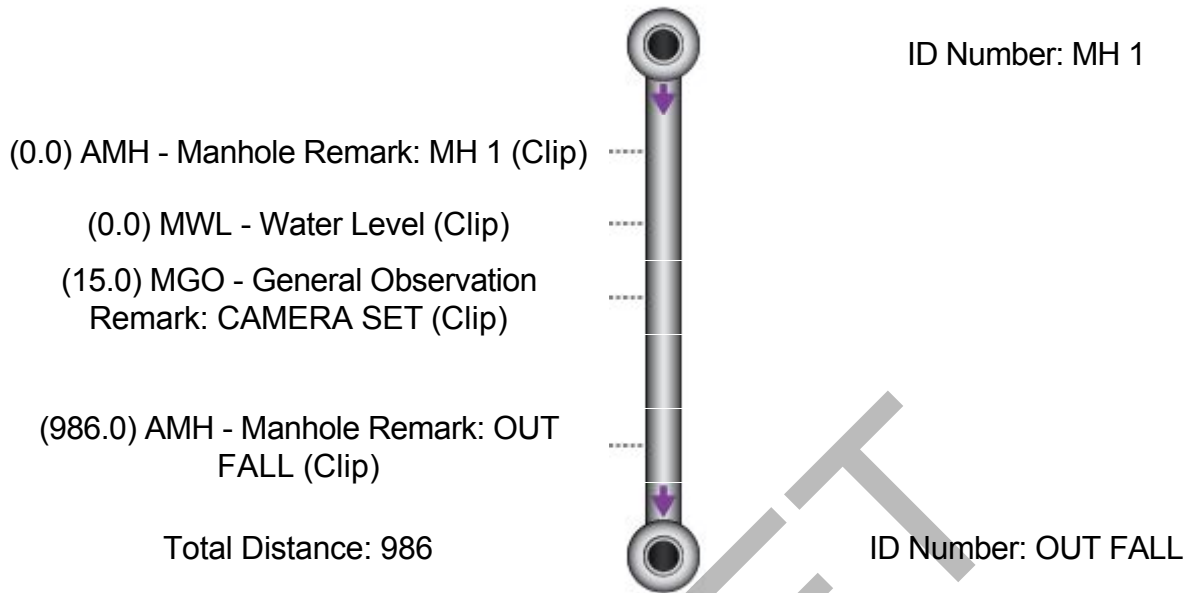

Created with the  report generator

Nassco C.C.T.V. Defect Code Information

Grade	Structural	O&M	Overall
5	0	0	0
4	0	0	0
3	0	0	0
2	0	0	0
1	0	0	0
Overall	0	0	0
Number of Defects	0	0	0
Pipe Rating	0000	0000	0000
Pipe Ratings Index	0	0	0

Nassco C.C.T.V. Defect Code Information

Distance	Video Ref	Code	Cont Defect	Value			Joint	Circumferential Location	
				Dimension		%		At / From	To
				1st	2nd				
0	35	AMH - Manhole							
		MH 1							
0	52	MWL - Water Level			25				
15	210	MGO - General Observation							
		CAMERA SET							
986	2511	AMH - Manhole							
		OUT FALL							

APPENDIX B

18-INCH OUTFALL INSPECTION REPORT

DRAFT

Project Information 1

Surveyor Name	steve	Certificate Number	1434
Owner	CRESCENT CITY	Customer	
Drainage Area		PO Number	
Pipe Segment Reference		Date	7/13/2019 21:30
Street	battery point	City	CRESCENT
Comments			

Manhole

Upstream MH	PLANT	Rim to Invert (U)	
Grade to Invert (U)		Rim to Grade (U)	
Downstream MH	MH 1	Rim to Invert (D)	
Grade to Invert (D)		Rim to Grade (D)	
Sewer Use		Direction of Survey	Upstream

Pipe

Height (Diameter)	18	Width	
Shape	Circular	Material	Ductile Iron Pipe
Lining Method		Pipe Joint Length	
Total Length		Length Surveyed	498.7
Year Laid		Year Renewed	

Misc

Flow Control		Media Label	DVD
Purpose		Sewer Category	
Pre-Cleaning	No Pre-Cleaning	Date Cleaned	
Weather		Location Code	
Additional Info		Location Details	

Custom

Custom1	1	Custom2	0
Custom3	0	Custom4	0
Custom5	0	Custom6	
Custom7		Custom8	
Custom9		Video Location	

Project: CRESCENT

Date: 7/13/2019 9:30:00 PM

Street: battery point

Length Surveyed: 498.7

Pacp Quick Overall Rating: 0000

Height (Diameter): 18

Street: battery point



Pipe Segment Reference:



Upstream MH: PLANT

Downstream MH: MH 1

Direction of Survey: Upstream

Material: Ductile Iron Pipe

Distance	Fault Observation	Time	Picture
0.0	<p>Manhole Severity: None Remarks: centerline</p>	39	 <p>MH MH 1 TO MH PLANT 7/13/2019 CRESCENT 21:32</p> <p>Manhole 0 FT centerline</p>
0.0	<p>Water Level Severity: None Percent: 5</p>	57	 <p>MH MH 1 TO MH PLANT 7/13/2019 CRESCENT 21:33</p> <p>Water Level 0 FT</p>
10.0	<p>General Observation Severity: None Remarks: CAMERA SET</p>	02:02	 <p>MH MH 1 TO MH PLANT 7/13/2019 CRESCENT 21:34</p> <p>General Observati 10 FT CAMERA SET</p>

Distance	Fault Observation	Time	Picture
246.5	Tap Factory Abandoned Position: 12 Severity: None Size: 12	12:02	
498.7	Manhole Severity: None Remarks: PLANT	24:26	

Created with the  report generator

DRAFT

Project: CRESCENT

Date: 7/13/2019 9:30:00 PM

Street: battery point

Length Surveyed: 498.7

Pacp Quick Overall Rating:
0000

Height (Diameter): 18

Street: battery point

Pipe Segment Reference:

Upstream MH: PLANT

Downstream MH: MH 1

Direction of Survey: Upstream

Material: Ductile Iron Pipe

Severity
Light
Moderate
Average
Heavy
Severe

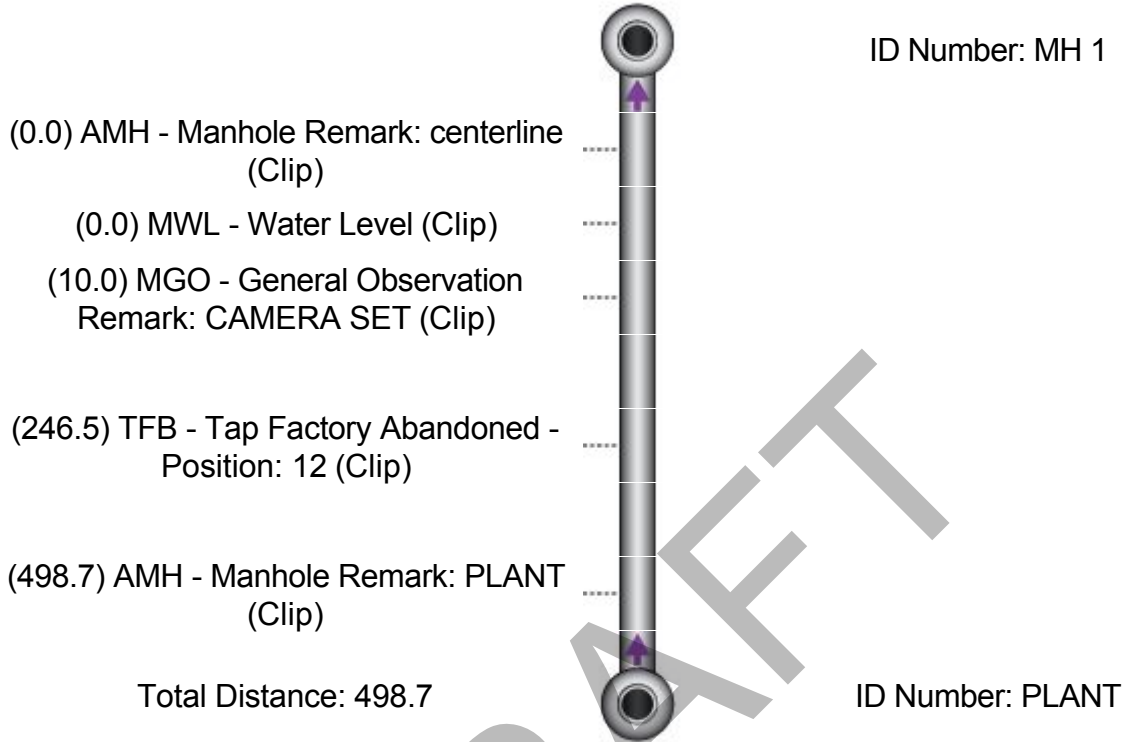

Created with the  report generator

Nassco C.C.T.V. Defect Code Information

Grade	Structural	O&M	Overall
5	0	0	0
4	0	0	0
3	0	0	0
2	0	0	0
1	0	0	0
Overall	0	0	0
Number of Defects	0	0	0
Pipe Rating	0000	0000	0000
Pipe Ratings Index	0	0	0

Nassco C.C.T.V. Defect Code Information

Distance	Video Ref	Code	Cont Defect	Value			Joint	Circumferential Location	
				Dimension		%		At / From	To
				1st	2nd				
0	39	AMH - Manhole							
		centerline							
0	57	MWL - Water Level			5				
10	122	MGO - General Observation							
		CAMERA SET							
246.5	722	TFB - Tap Factory Abandoned		12			12		
498.7	1466	AMH - Manhole							
		PLANT							

APPENDIX C

STORMWATER PUMP MAINTENANCE MANAGEMENT SYSTEM

DRAFT



Maintenance Details

Requested: 12/1/2019 2:05:30 AM
Problem: System Generated (SYSGEN-PROB)
Procedure: ANNUAL STORM WATER PUMP MOTOR INSPECTION (CEC-MOTOR10-A)
Last PM: 11/26/2019
Reason: ANNUAL STORM WATER PUMP MOTOR INSPECTION

Target: 12/25/2019 (0.5) hr
Priority/Type: Normal / Preventive Maintenance
Shop: CEC

- JACOBS - Municipal West
- Crescent City Project
- Crescent City Project Site
- Effluent Pump Building
- Storm Water Pump 1, P-6410 (CEC-PUMP-VT-253)
- Storm Water Pump 1, P-6410 Motor (CEC-MOTOR-1398)**

Contact:
Phone:

- Warranty Shutdown Lockout Attach Charge

Tasks

#	Description	Rating	Meas.	Initials	Failed	N/A	Complete
<p>Safety Reminder</p> <p>If during the course of performing your job, task or assignment, you need help or guidance, if you have concerns, that you cannot perform your work (task) in a completely safe manner or environment. You are required to eliminate the risk before beginning the task or job, seek help, information or additional resources and proceed only when it is safe to do so.</p>							
20				AN	<input type="checkbox"/>	<input type="checkbox"/>	<input checked="" type="checkbox"/>
Annual Tasks - Note: Pump can only be operated in high flow situation							
35	Check / change upper bearing oil as needed (30wt nd)			AN	<input type="checkbox"/>	<input type="checkbox"/>	<input checked="" type="checkbox"/>
40	Lube lower motor bearing (2 strokes EP-2 grease)			AN	<input type="checkbox"/>	<input type="checkbox"/>	<input checked="" type="checkbox"/>
50	Check / clean cooling fins, cooling fan inlet as needed			AN	<input type="checkbox"/>	<input type="checkbox"/>	<input checked="" type="checkbox"/>
60	Check for unusual noise / heat / vibration			AN	<input type="checkbox"/>	<input type="checkbox"/>	<input checked="" type="checkbox"/>
					<input type="checkbox"/>	<input type="checkbox"/>	<input type="checkbox"/>

Labor

Labor	Account	Work Date Start	End	Reg Hrs	OT Hrs	Other Hrs

Parts/Tools

Barcode Item	Location	Account	Est Qty	Actual Qty

Labor Report

Completed: _____ **Failure:** _____ **Meter 1:** _____ **Meter 2:** _____

Report:

We apologize, as there was a problem encountered while sending you a confirmation email. ([Error: No valid recipients and/or sender found]).

DRAFT



Maintenance Details

Requested: 12/1/2019 2:05:30 AM
Problem: System Generated (SYSGEN-PROB)
Procedure: ANNUAL STORM WATER PUMP MOTOR INSPECTION (CEC-MOTOR10-A)
Last PM: 11/26/2019
Reason: ANNUAL STORM WATER PUMP MOTOR INSPECTION

Target: 12/25/2019 (0.5) hr
Priority/Type: Normal / Preventive Maintenance
Shop: CEC

- JACOBS - Municipal West
- Crescent City Project
- Crescent City Project Site
- Effluent Pump Building
- Storm Water Pump 2, P-6420 (CEC-PUMP-VT-254)
- Storm Water Pump 2, P-6420 Motor (CEC-MOTOR-1399)**

Contact:
Phone:

- Warranty Shutdown Lockout Attach Charge

Tasks

#	Description	Rating	Meas.	Initials	Failed	N/A	Complete
Safety Reminder If during the course of performing your job, task or assignment, you need help or guidance, if you have concerns, that you cannot perform your work (task) in a completely safe manner or environment. You are required to eliminate the risk before beginning the task or job, seek help, information or additional resources and proceed only when it is safe to do so.							
20				AN	<input type="checkbox"/>	<input type="checkbox"/>	<input checked="" type="checkbox"/>
Annual Tasks - Note: Pump can only be operated in high flow situation							
35	Check / change upper bearing oil as needed (30wt nd)			AN	<input type="checkbox"/>	<input type="checkbox"/>	<input checked="" type="checkbox"/>
40	Lube lower motor bearing (2 strokes EP-2 grease)			AN	<input type="checkbox"/>	<input type="checkbox"/>	<input checked="" type="checkbox"/>
50	Check / clean cooling fins, cooling fan inlet as needed			AN	<input type="checkbox"/>	<input type="checkbox"/>	<input checked="" type="checkbox"/>
60	Check for unusual noise / heat / vibration			AN	<input type="checkbox"/>	<input type="checkbox"/>	<input checked="" type="checkbox"/>
					<input type="checkbox"/>	<input type="checkbox"/>	<input type="checkbox"/>

Labor

Labor	Account	Work Date Start	End	Reg Hrs	OT Hrs	Other Hrs

Parts/Tools

Barcode Item	Location	Account	Est Qty	Actual Qty

Labor Report

Completed: _____ **Failure:** _____ **Meter 1:** _____ **Meter 2:** _____

Report:

We apologize, as there was a problem encountered while sending you a confirmation email. ([Error: No valid recipients and/or sender found]).

DRAFT

Appendix D:

Form 2A Section 3.20- Chronic Toxicity Testing 2016-2020



Sandi Byrne
Crescent City Water Quality Control Laboratory
377 J Street
Crescent City, CA 95531

August 31, 2016

Sandi:

I have enclosed our report "NPDES Compliance Chronic Toxicity Testing of City of Crescent City Wastewater Treatment Plant Effluent" for the effluent sample collected August 16, 2016. The results of this test are summarized below.

Chronic Effects of Crescent City Effluent on Giant Kelp (Macrocystis pyrifera)

There were no significant reductions in kelp germination; the germination NOEC was 13.2% effluent, resulting in 7.6 TUc. There were significant reductions in kelp growth; the growth NOEC was 0.8% effluent, resulting in 125 TUc.

Table with 3 columns: Kelp Test Endpoint =, Germination, Growth. Rows include NOEC, TUc (100/NOEC), Germination EC25 or Growth IC25, and TUc (100/EC25 or 100/IC25).

TSD (NOEC) vs. EC25-IC25 vs. TST

The test data were also analyzed using the Test of Significant Toxicity (TST) statistical method to compare the results of the proposed method to the current approach of calculating TUc as 100/NOEC, as well as 100/EC25 and 100/IC25. As indicated below, these alternative statistical methods do not support the determination of toxicity

Table with 6 columns: TSD (NOEC) Method, EC25/IC25 Method, TST Method. Sub-columns for Germination and Growth. Results are non-toxic for all.

Note - The TST method does not use TUc to determine compliance with a numeric limit, but rather is based simply on a "non-toxic/toxic" basis. The above comparative table has been prepared accordingly, with the TUc calculated from EC25 and IC25 point estimates or the NOEC being characterized as "non-toxic/toxic".

If you have any questions regarding this testing, please feel free to call my colleague Dr. Brant Jorgenson or myself at (707) 207-7760.

Regards,

Mike McElroy



2016.08.31

16:06:45 -08'00'

Michael McElroy

Senior Aquatic Ecotoxicologist



Pacific EcoRisk is accredited in accordance with NELAP (ORELAP ID 4043). Pacific EcoRisk certifies that the test results reported herein conform to the most current NELAP requirements for parameters for which accreditation is required and available. Any exceptions to NELAP requirements are noted, where applicable, in the body of the report. This report shall not be reproduced, except in full, without the written consent of Pacific EcoRisk. This testing was performed under Lab Order 26158.

NPDES Compliance Chronic Toxicity Testing of City of Crescent City Wastewater Treatment Plant Effluent

Sample collected August 16, 2016

Performed For

Crescent City
Water Quality Control Laboratory
377 J Street
Crescent City, CA 95531

Prepared By

Pacific EcoRisk
2250 Cordelia Road
Fairfield, CA 94534

August 2016



PACIFIC ECORISK
ENVIRONMENTAL CONSULTING & TESTING

NPDES Compliance Chronic Toxicity Testing of City of Crescent City Wastewater Treatment Plant Effluent

Sample collected August 16, 2016

Table of Contents

	Page
1. INTRODUCTION	1
2. TOXICITY TEST PROCEDURES	1
2.1 Receipt and Handling of the Effluent Sample	1
2.2 Algal Germination and Growth Toxicity Testing with <i>Macrocystis pyrifera</i>	1
2.2.1 Reference Toxicant Testing of the <i>Macrocystis pyrifera</i>	2
3. TESTING RESULTS	3
3.1 Effects of Crescent City Effluent on <i>Macrocystis pyrifera</i>	3
3.2 Reference Toxicant Toxicity to <i>Macrocystis pyrifera</i>	4
4. SUMMARY AND CONCLUSIONS	5
4.1 QA/QC Summary	5

Appendices

- Appendix A Chain-of-Custody Record for the Collection and Delivery of the Crescent City Effluent Sample

- Appendix B Test Data and Summary of Statistics for the Evaluation of the Chronic Toxicity of Crescent City Effluent to the Giant Kelp *Macrocystis pyrifera*

- Appendix C Test Data and Summary of Statistics for the Reference Toxicant Evaluation of the Giant Kelp *Macrocystis pyrifera*



1. INTRODUCTION

Crescent City has contracted Pacific EcoRisk (PER) to perform an evaluation of the chronic toxicity of Crescent City Wastewater Treatment Plant (Crescent City) effluent. This toxicity evaluation consisted of performing the US EPA's short-term chronic toxicity test with giant kelp (*Macrocystis pyrifera*) utilizing an effluent sample collected August 16, 2016. In order to assess the sensitivity of the test organisms to toxic stress, a concurrent reference toxicant test was also performed. This report describes the performance and results of this testing.

2. TOXICITY TEST PROCEDURES

The methods used in this testing followed the guidelines established by the EPA manual "Short-Term Methods for Measuring the Chronic Toxicity of Effluents and Receiving Waters to West Coast Marine and Estuarine Organisms" (EPA/600/R-95/136).

2.1 Receipt and Handling of the Effluent Sample

On August 16, a sample of Crescent City effluent was collected into an appropriately cleaned sample container and shipped via overnight delivery, on ice and under chain-of-custody, to the PER laboratory in Fairfield, CA. Upon receipt at the laboratory, aliquots of the sample were collected for analysis of initial water quality characteristics (Table 1), with the remainder of the sample being stored at $\leq 6^{\circ}\text{C}$, except when being used to prepare test solutions. The chain-of-custody record for the collection and delivery of this sample is presented in Appendix A.

Table 1. Initial water quality characteristics of Crescent City effluent samples.

Sample Received	Sample ID	Temp ($^{\circ}\text{C}$)	pH	D.O (mg/L)	Salinity (ppt)	Conductivity ($\mu\text{S}/\text{cm}$)	Total Ammonia (mg/L N)
8/17/16	Effluent Grab	1.7	7.73	7.5	0.3	693	13.6

2.2 Algal Germination and Growth Toxicity Testing with *Macrocystis pyrifera*

This chronic toxicity test with *M. pyrifera* consists of exposing kelp zoospores to the effluent for approximately 48 hours, after which the effects on zoospore germination and subsequent gametophyte growth (measured as gametophyte tube length) are determined. The specific procedures used in this test are described below.

The Lab Water Control medium for this test consisted of filtered (1- μm) natural seawater (obtained from the U.C. Granite Canyon Marine Laboratory Carmel, CA). The effluent was adjusted to the test salinity of 34 ppt via addition of hypersaline brine (HSB). The Lab Water Control medium and salinity-adjusted effluent were then used to prepare test solutions at test

treatment concentrations of 0.8%, 1.6%, 3.3%, 6.6%, and 13.2% effluent. As an additional QA measure and in order to assess potential effects of the HSB addition on the effluent, a "Brine Control" was also prepared consisting of filtered seawater diluted to the salinity of the effluent sample using Type 1 lab water, and then adjusted back up to the test salinity of 34 ppt via addition of the HSB. Routine water quality characteristics (pH, D.O., and salinity) were measured for each test solution prior to use in this test.

Zoospores were obtained from kelp fronds (blades) of *M. pyrifera* collected from wild populations (K. Siewers, Santa Cruz, CA). Approximately 25 fronds were cleaned of debris and epiphytic organisms by gently rubbing the blades while rinsing with 1- μ m filtered seawater, after which the blades were further desiccated by being exposed to air for approximately one hour. The desiccated kelp fronds were then rinsed with filtered seawater and placed into a 1-L glass beaker containing 1- μ m filtered seawater at 15°C in order to induce release of zoospores. After allowing zoospore release for approximately one hour, the kelp fronds were removed from the beakers, and the remaining solution was allowed to settle for 30 minutes, after which approximately 25% of the overlying water was decanted from the top of the solution into a separate clean beaker. Zoospore density was determined using a hemacytometer.

There were five replicates at each test treatment, each replicate consisting of a 450-mL polyethylene dish containing 200 mL of test solution. A glass microscope slide was placed into each replicate to provide a zoospore settling and germination substrate, after which the test was initiated by the addition of zoospores into each replicate to a final density of approximately 7,500 spores/mL. These replicate containers were randomly positioned within a temperature-controlled room at 15°C, under cool-white fluorescent lighting on a 16L:8D photoperiod.

After 48 (\pm 2) hours exposure, the contents of each test container were fixed via addition of glutaraldehyde. Each replicate slide was subsequently examined microscopically to determine the percent successful germination of the settled zoospores and the growth of the resulting gametophytes, as measured by germ tube length. The resulting germination and germ tube length data were analyzed to determine any impairment resulting from exposure to the effluent. All statistical analyses were performed using the CETIS[®] statistical software (TidePool Scientific, McKinleyville, CA).

2.2.1 Reference Toxicant Testing of the *Macrocystis pyrifera*

In order to assess the sensitivity of the test organisms to toxic stress, a reference toxicant test was performed. This reference toxicant test was performed similarly to the effluent toxicity test, except that test solutions consisted of Lab Water Control medium (filtered seawater) spiked with KCl at concentrations of 2, 4, 8, 16, 24, and 32 g/L. The resulting test response data were analyzed to determine key dose-response point estimates. All statistical analyses were made using the CETIS software. These response endpoints were then compared to the typical response ranges established by the mean \pm 2 SD of the point estimates generated by the most recent previous reference toxicant tests performed by this lab.

3. TESTING RESULTS

3.1 Effects of Crescent City Effluent on *Macrocystis pyrifera*

The results of this test are summarized below in Table 2. There were no significant reductions in kelp germination; the germination NOEC was 13.2% effluent, resulting in 7.6 TUc. There were significant reductions in kelp growth; the growth NOEC was 0.8% effluent, resulting in 125 TUc. It should be noted, however, when evaluated on the basis of TUc determined by the EC₂₅/IC₂₅ and EPA's Test of Significant Toxicity (TST), the effluent is considered not toxic to kelp germination or growth. Test data and summary of statistical analyses are presented in Appendix B.

Effluent Treatment	Mean % Germination	Mean Germ Tube Length (μm)
Brine Control	82.8	15.7
Lab Water Control	79.8	16.2
0.8%	80.8	15.2 ^a
1.6%	80.2	14.6*
3.3%	77.0	14.2*
6.6%	76.6	13.3*
13.2%	76.4	12.5*
Summary of Key Statistics		
NOEC =	13.2% effluent	0.8% effluent
TUc (100/NOEC) =	7.6	125
Germination EC ₂₅ or Growth IC ₂₅ =	>13.2% effluent ^b	>13.2% effluent
TUc (100/EC ₂₅ or 100/IC ₂₅) =	<7.6	<7.6

* The response at this test treatment was significantly less than the Lab Water Control response at $p < 0.05$.

a - The PMSD for this test and the relative percent difference of this treatment from the control was less than the 10th percentile PMSD for *Macrocystis pyrifera* published by Denton et al. (2003)¹. Based on best professional judgment, and consistent with EPA methodology with regard to use of PMSD, effects at this treatment are considered not significant.

b - Due to the absence of any reductions in germination, the EC point estimates could not be calculated, but can be determined by inspection to be >13.2% effluent.

¹ Denton, DL, JF Fox, FA Fulk. 2003. Enhancing toxicity test performance by using a statistical criterion. *Environ Toxicol Chem.* 22:2323-2328.

3.2 Reference Toxicant Toxicity to *Macrocystis pyrifera*

The results of this test are summarized in Table 3. The germination EC₅₀ and growth IC₅₀ for this test were consistent with the typical response ranges established by reference toxicant test database for this species, indicating that the test organisms were responding to toxic stress in a typical fashion. The test data and summary of statistical analyses for this test are presented in Appendix C.

Table 3. Reference toxicity testing: effects of KCl on <i>Macrocystis pyrifera</i> .		
KCl Concentration (gm/L)	Mean % Germination	Mean Germ Tube Length (μ m)
Lab Water Control	83.0	15.5
2	84.2	15.6
4	85.8	15.5
8	20.8*	12.7*
12	10.4*	12.1*
16	0*	-
32	0*	-
Summary of Statistics		
Germination EC ₅₀ or Growth IC ₅₀ =	6.9 g/L KCl	13.4 g/L KCl

* The response at this test treatment was significantly less than the Lab Water Control response at $p < 0.05$.

4. SUMMARY AND CONCLUSIONS

An evaluation of the chronic toxicity of Crescent City effluent was performed using an effluent sample collected August 16, 2016. The results of this test are summarized below.

Chronic Effects of Crescent City Effluent on Giant Kelp (*Macrocystis pyrifera*)

There were no significant reductions in kelp germination; the germination NOEC was 13.2% effluent, resulting in 7.6 TUc. There were significant reductions in kelp growth; the growth NOEC was 0.8% effluent, resulting in 125 TUc. It should be noted, however, when evaluated on the basis of TUc determined by the EC25/IC25 and EPA's TST, the effluent is considered not toxic to kelp germination or growth.

4.1 QA/QC Summary

Test Conditions – Test conditions (pH, D.O., temperature, etc.) were within acceptable limits. All analyses were performed according to laboratory Standard Operating Procedures.

Negative Control – The biological responses at the Lab Control treatments were within acceptable limits.

Positive Control – The results of the reference toxicant test were consistent with the typical response ranges established by the reference toxicant test database for this species, indicating that these test organisms were responding to toxicant stress in a typical and consistent fashion.

Concentration Response Relationships – The concentration-response relationships for these tests were evaluated as per EPA guidelines (EPA-821-B-00-004) and were determined to be acceptable.

Appendix A

Chain-of-Custody Record for the Collection and Delivery of the Crescent City Effluent Sample

Pacific EcoRisk

2250 Cordelia Rd., Fairfield, CA 94534
(707) 207-7760 FAX (707) 207-7916

CHAIN-OF-CUSTODY RECORD

Results To: Crescent City Water Quality Control Lab				Invoice To: Same			
Address: 377 J Street				Address:			
Crescent City, CA 95531							
Phone: 707-465-5258				Phone:			
Attn: Sandi Byme				Attn:			
E-mail: sbyrne@crescentcity.org				E-mail:			
Project Name: Crescent City							
P.O.#/Ref: # 45596							
Client Sample ID	Sample Date	Sample Time	Sample Matrix*	Grab/Comp	Number	Container Type	Requested Analysis
EFFLUENT G	8/16/16	1310	EFF	grab	1	Substance	Chronic Macrocyts pyrrera, EPA 1009.0
Samples collected by: Andrew G. Beaudt							
Comments/Special Instruction:							
Perform testing in accordance with NPDES permit							
Perform concurrent chronic reference toxicant tests.							
RELINQUISHED BY:				RECEIVED BY:			
Signature: Andrew G. Beaudt				Signature: [Signature]			
Print: Andrew G. Beaudt				Print: Regina T. Hill			
Organization: CWWTP				Organization: CWWBL			
Date: 8/16/16				Date: 8/16/16			
Time: 1315				Time: 1315			
RELINQUISHED BY:				RECEIVED BY:			
Signature: [Signature]				Signature: [Signature]			
Print: Regina T. Hill				Print: Y. Khadijawa			
Organization: CWWBL				Organization: PWR			
Date: 8/16/16				Date: 8-17-16			
Time: 1325				Time: 1415			

*Example Matrix Codes: (EFF = Effluent) (FW = Freshwater); (SW = Saltwater); (WWT = Wastewater); (STRM = Stormwater); (SED = Sediment); or other

Appendix B

Test Data and Summary of Statistics for the Evaluation of the Chronic Toxicity of Crescent City Effluent to the Giant Kelp *Macrocystis pyrifera*

CETIS Summary Report

Report Date: 23 Aug-16 17:17 (p 1 of 2)
 Test Code: 69320 | 14-9419-5486

Macrocystis Germination and Growth Test Pacific EcoRisk

Batch ID: 03-4527-6343	Test Type: Growth-Germination	Analyst: Mike McElroy
Start Date: 17 Aug-16 17:05	Protocol: EPA/600/R-95/136 (1995)	Diluent: Filtered Seawater
Ending Date: 19 Aug-16 16:10	Species: Macrocystis pyrifera	Brine: Hyper-Saline Brine
Duration: 47h	Source: Dave Gutoff	Age: NA

Sample ID: 01-7499-9598	Code: NPDES	Client: Crescent City
Sample Date: 16 Aug-16 13:10	Material: Effluent	Project: 26158
Receive Date: 17 Aug-16 14:15	Source: Crescent City Harbor	
Sample Age: 28h (1.7 °C)	Station: Effluent-G	

Comparison Summary

Analysis ID	Endpoint	NOEL	LOEL	TOEL	PMSD	TU	Method
04-9466-2046	Germination Rate	0	>0		6.41%		Equal Variance t Two-Sample Test
03-3326-1267	Germination Rate	13.2	>13.2	NA	10.5%	7.576	Dunnett Multiple Comparison Test
14-6484-5550	Mean Length	<0	0		1.81%		Equal Variance t Two-Sample Test
07-7042-8868	Mean Length	<0.8	0.8	NA	4.18%	>125	Dunnett Multiple Comparison Test

Point Estimate Summary

Analysis ID	Endpoint	Level	%	95% LCL	95% UCL	TU	Method
00-9766-3102	Mean Length	IC5	0.617	0.386	1.02	162	Linear Interpolation (ICPIN)
		IC10	1.68	0.998	3.97	59.35	
		IC15	4.79	2.58	6.25	20.86	
		IC20	8.99	5.2	12.9	11.12	
		IC25	>13.2	N/A	N/A	<7.576	
		IC40	>13.2	N/A	N/A	<7.576	
		IC50	>13.2	N/A	N/A	<7.576	

Germination Rate Summary

C-%	Control Type	Count	Mean	95% LCL	95% UCL	Min	Max	Std Err	Std Dev	CV%	%Effect
0	Lab Water Contr	5	0.798	0.745	0.851	0.74	0.86	0.0191	0.0427	5.35%	0.0%
0	Brine Control	5	0.828	0.778	0.878	0.77	0.87	0.018	0.0402	4.86%	-3.76%
0.8		5	0.808	0.747	0.869	0.75	0.87	0.022	0.0492	6.09%	-1.25%
1.6		5	0.802	0.724	0.88	0.73	0.9	0.0282	0.063	7.86%	-0.5%
3.3		5	0.77	0.671	0.869	0.64	0.83	0.0356	0.0797	10.3%	3.51%
6.6		5	0.766	0.715	0.817	0.72	0.82	0.0183	0.041	5.35%	4.01%
13.2		5	0.764	0.717	0.811	0.74	0.83	0.0169	0.0378	4.95%	4.26%

Mean Length Summary

C-%	Control Type	Count	Mean	95% LCL	95% UCL	Min	Max	Std Err	Std Dev	CV%	%Effect
0	Lab Water Contr	5	16.2	15.9	16.5	16	16.5	0.0935	0.209	1.29%	0.0%
0	Brine Control	5	15.7	15.3	16	15.3	16	0.127	0.285	1.82%	3.4%
0.8		5	15.2	14.5	15.8	14.5	15.8	0.218	0.487	3.22%	<u>6.48%</u>
1.6		5	14.6	13.9	15.3	14	15.5	0.257	0.576	3.94%	9.88%
3.3		5	14.2	13.5	14.9	13.5	15	0.242	0.542	3.82%	12.3%
6.6		5	13.3	12.8	13.7	12.8	13.8	0.177	0.395	2.98%	18.2%
13.2		5	12.5	11.9	13	12	13	0.184	0.411	3.3%	23.1%

CETIS Summary Report

Report Date: 23 Aug-16 17:17 (p 2 of 2)
 Test Code: 69320 | 14-9419-5486

Macrocystis Germination and Growth Test							Pacific EcoRisk
Germination Rate Detail							
C-%	Control Type	Rep 1	Rep 2	Rep 3	Rep 4	Rep 5	
0	Lab Water Contr	0.8	0.74	0.86	0.79	0.8	
0	Brine Control	0.87	0.83	0.81	0.86	0.77	
0.8		0.84	0.75	0.77	0.87	0.81	
1.6		0.77	0.9	0.8	0.73	0.81	
3.3		0.83	0.8	0.64	0.83	0.75	
6.6		0.72	0.78	0.78	0.73	0.82	
13.2		0.74	0.75	0.83	0.74	0.76	
Mean Length Detail							
C-%	Control Type	Rep 1	Rep 2	Rep 3	Rep 4	Rep 5	
0	Lab Water Contr	16	16	16.5	16.3	16.3	
0	Brine Control	15.8	15.3	15.5	16	15.8	
0.8		15	15.5	15	14.5	15.8	
1.6		14	14.8	14.3	15.5	14.5	
3.3		15	13.5	14.3	14	14.3	
6.6		12.8	13.3	13.5	13.8	13	
13.2		12.3	13	12.8	12	12.3	
Germination Rate Binomials							
C-%	Control Type	Rep 1	Rep 2	Rep 3	Rep 4	Rep 5	
0	Lab Water Contr	80/100	74/100	86/100	79/100	80/100	
0	Brine Control	87/100	83/100	81/100	86/100	77/100	
0.8		84/100	75/100	77/100	87/100	81/100	
1.6		77/100	90/100	80/100	73/100	81/100	
3.3		83/100	80/100	64/100	83/100	75/100	
6.6		72/100	78/100	78/100	73/100	82/100	
13.2		74/100	75/100	83/100	74/100	76/100	

CETIS Analytical Report

Report Date: 23 Aug-16 17:17 (p 1 of 5)
 Test Code: 69320 | 14-9419-5486

Macrocystis Germination and Growth Test Pacific EcoRisk

Analysis ID: 03-3326-1267 Endpoint: Germination Rate CETIS Version: CETISv1.8.7
 Analyzed: 23 Aug-16 17:16 Analysis: Parametric-Control vs Treatments Official Results: Yes

Data Transform	Zeta	Alt Hyp	Trials	Seed	PMSD	NOEL	LOEL	TOEL	TU
Angular (Corrected)	NA	C > T	NA	NA	10.5%	13.2	>13.2	NA	7.576

Dunnett Multiple Comparison Test

Control	vs	C-%	Test Stat	Critical	MSD	DF	P-Value	P-Type	Decision(α:5%)
Lab Water Control		0.8	-0.315	2.36	0.1	8	0.9097	CDF	Non-Significant Effect
		1.6	-0.184	2.36	0.1	8	0.8819	CDF	Non-Significant Effect
		3.3	0.75	2.36	0.1	8	0.5340	CDF	Non-Significant Effect
		6.6	0.929	2.36	0.1	8	0.4520	CDF	Non-Significant Effect
		13.2	0.986	2.36	0.1	8	0.4262	CDF	Non-Significant Effect

ANOVA Table

Source	Sum Squares	Mean Square	DF	F Stat	P-Value	Decision(α:5%)
Between	0.01567972	0.003135943	5	0.699	0.6294	Non-Significant Effect
Error	0.1076531	0.004485544	24			
Total	0.1233328		29			

Distributional Tests

Attribute	Test	Test Stat	Critical	P-Value	Decision(α:1%)
Variances	Bartlett Equality of Variance	3.04	15.1	0.6941	Equal Variances
Distribution	Shapiro-Wilk W Normality	0.98	0.903	0.8359	Normal Distribution

Germination Rate Summary

C-%	Control Type	Count	Mean	95% LCL	95% UCL	Median	Min	Max	Std Err	CV%	%Effect
0	Lab Water Contr	5	0.798	0.745	0.851	0.8	0.74	0.86	0.0191	5.35%	0.0%
0.8		5	0.808	0.747	0.869	0.81	0.75	0.87	0.022	6.09%	-1.25%
1.6		5	0.802	0.724	0.88	0.8	0.73	0.9	0.0282	7.86%	-0.5%
3.3		5	0.77	0.671	0.869	0.8	0.64	0.83	0.0356	10.3%	3.51%
6.6		5	0.766	0.715	0.817	0.78	0.72	0.82	0.0183	5.35%	4.01%
13.2		5	0.764	0.717	0.811	0.75	0.74	0.83	0.0169	4.95%	4.26%

Angular (Corrected) Transformed Summary

C-%	Control Type	Count	Mean	95% LCL	95% UCL	Median	Min	Max	Std Err	CV%	%Effect
0	Lab Water Cont	5	1.11	1.04	1.17	1.11	1.04	1.19	0.0242	4.88%	0.0%
0.8		5	1.12	1.04	1.2	1.12	1.05	1.2	0.0283	5.65%	-1.21%
1.6		5	1.11	1.01	1.22	1.11	1.02	1.25	0.0376	7.54%	-0.7%
3.3		5	1.07	0.961	1.19	1.11	0.927	1.15	0.041	8.53%	2.87%
6.6		5	1.07	1.01	1.13	1.08	1.01	1.13	0.0218	4.57%	3.55%
13.2		5	1.06	1.01	1.12	1.05	1.04	1.15	0.0207	4.35%	3.77%

Macrocystis Germination and Growth Test

Pacific EcoRisk

Analysis ID: 03-3326-1267

Endpoint: Germination Rate

CETIS Version: CETISv1.8.7

Analyzed: 23 Aug-16 17:16

Analysis: Parametric-Control vs Treatments

Official Results: Yes

Graphics

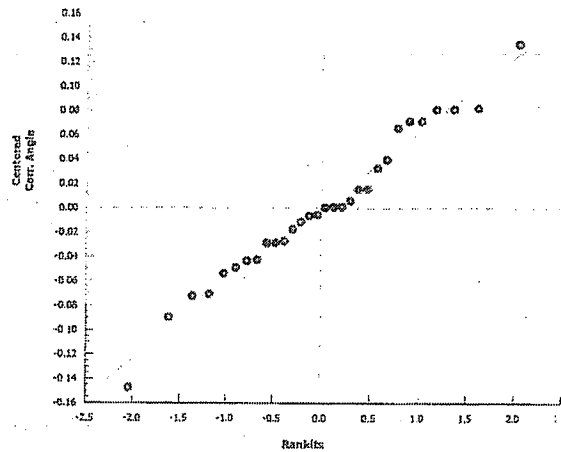
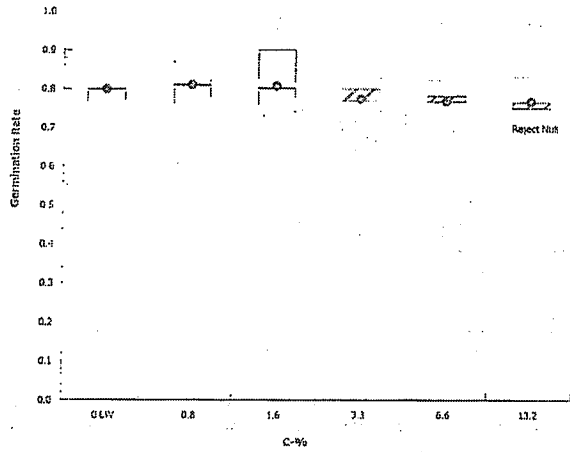

CETIS Analytical Report

Report Date: 23 Aug-16 17:17 (p 4 of 5)
 Test Code: 69320 | 14-9419-5486

Macrocystis Germination and Growth Test Pacific EcoRisk

Analysis ID: 07-7042-8868 Endpoint: Mean Length CETIS Version: CETISv1.8.7
 Analyzed: 23 Aug-16 17:16 Analysis: Parametric-Control vs Treatments Official Results: Yes

Data Transform	Zeta	Alt Hyp	Trials	Seed	PMSD	NOEL	LOEL	TOEL	TU
Untransformed	NA	C > T	NA	NA	4.18%	<0.8	0.8	NA	>125

Dunnett Multiple Comparison Test

Control	vs	C-%	Test Stat	Critical	MSD	DF	P-Value	P-Type	Decision(α:5%)
Lab Water Control		0.8*	3.66	2.36	0.677	8	0.0027	CDF	Significant Effect
		1.6*	5.58	2.36	0.677	8	<0.0001	CDF	Significant Effect
		3.3*	6.98	2.36	0.677	8	<0.0001	CDF	Significant Effect
		6.6*	10.3	2.36	0.677	8	<0.0001	CDF	Significant Effect
		13.2*	13.1	2.36	0.677	8	<0.0001	CDF	Significant Effect

ANOVA Table

Source	Sum Squares	Mean Square	DF	F Stat	P-Value	Decision(α:5%)
Between	44.78542	8.957084	5	43.6	<0.0001	Significant Effect
Error	4.925	0.2052083	24			
Total	49.71041		29			

Distributional Tests

Attribute	Test	Test Stat	Critical	P-Value	Decision(α:1%)
Variances	Bartlett Equality of Variance	3.75	15.1	0.5852	Equal Variances
Distribution	Shapiro-Wilk W Normality	0.97	0.903	0.5473	Normal Distribution

Mean Length Summary

C-%	Control Type	Count	Mean	95% LCL	95% UCL	Median	Min	Max	Std Err	CV%	%Effect
0	Lab Water Contr	5	16.2	15.9	16.5	16.3	16	16.5	0.0935	1.29%	0.0%
0.8		5	15.2	14.5	15.8	15	14.5	15.8	0.218	3.22%	6.48%
1.6		5	14.6	13.9	15.3	14.5	14	15.5	0.257	3.94%	9.88%
3.3		5	14.2	13.5	14.9	14.3	13.5	15	0.242	3.82%	12.3%
6.6		5	13.3	12.8	13.7	13.3	12.8	13.8	0.177	2.98%	18.2%
13.2		5	12.5	11.9	13	12.3	12	13	0.184	3.3%	23.1%

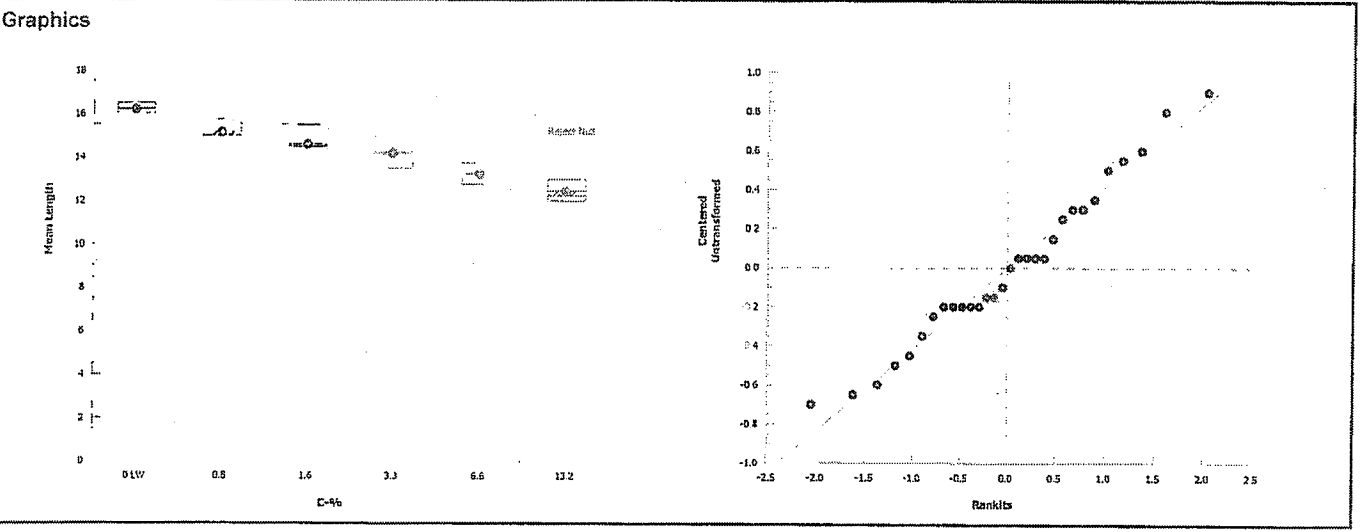

CETIS Analytical Report

Report Date: 23 Aug-16 17:17 (p 1 of 1)
 Test Code: 69320 | 14-9419-5486

Macrocystis Germination and Growth Test			Pacific EcoRisk		
Analysis ID: 00-9766-3102	Endpoint: Mean Length	CETIS Version: CETISv1.8.7			
Analyzed: 23 Aug-16 17:16	Analysis: Linear Interpolation (ICPIN)	Official Results: Yes			

Linear Interpolation Options					
X Transform	Y Transform	Seed	Resamples	Exp 95% CL	Method
Linear	Linear	1398729	200	Yes	Two-Point Interpolation

Point Estimates						
Level	%	95% LCL	95% UCL	TU	95% LCL	95% UCL
IC5	0.617	0.386	1.02	162	97.65	259.3
IC10	1.68	0.998	3.97	59.35	25.19	100.3
IC15	4.79	2.58	6.25	20.86	15.99	38.7
IC20	8.99	5.2	12.9	11.12	7.752	19.23
IC25	>13.2	N/A	N/A	<7.576	NA	NA
IC40	>13.2	N/A	N/A	<7.576	NA	NA
IC50	>13.2	N/A	N/A	<7.576	NA	NA

Mean Length Summary				Calculated Variate					
C-%	Control Type	Count	Mean	Min	Max	Std Err	Std Dev	CV%	%Effect
0	Lab Water Contr	5	16.2	16	16.5	0.0935	0.209	1.29%	0.0%
0.8		5	15.2	14.5	15.8	0.218	0.487	3.22%	6.48%
1.6		5	14.6	14	15.5	0.257	0.576	3.94%	9.88%
3.3		5	14.2	13.5	15	0.242	0.542	3.82%	12.3%
6.6		5	13.3	12.8	13.8	0.177	0.395	2.98%	18.2%
13.2		5	12.5	12	13	0.184	0.411	3.3%	23.1%

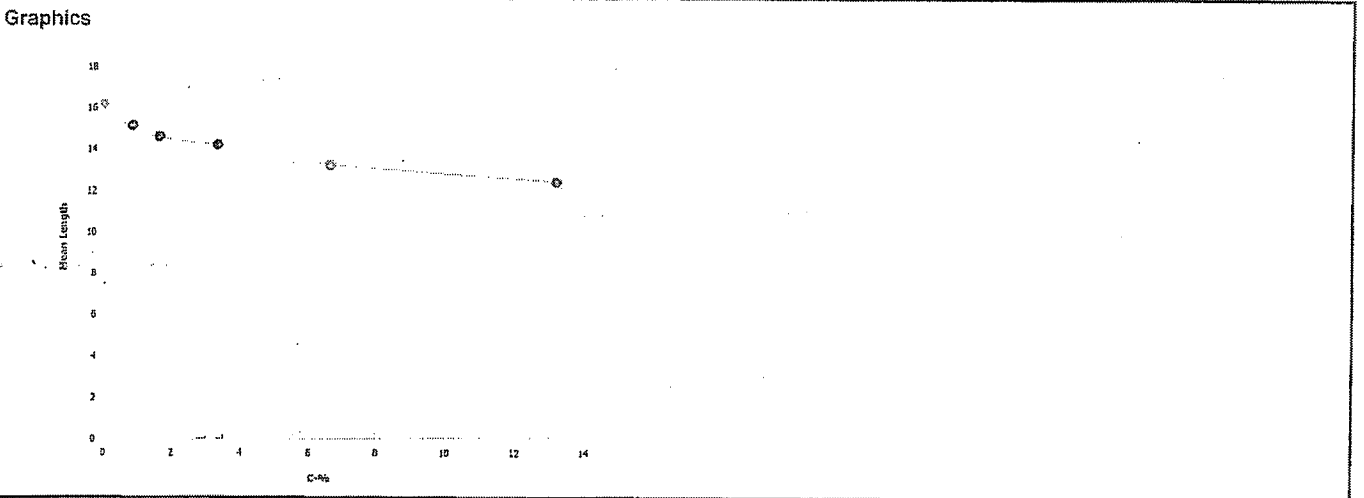

CETIS Analytical Report

Report Date: 23 Aug-16 17:17 (p 3 of 5)
 Test Code: 69320 | 14-9419-5486

Macrocystis Germination and Growth Test Pacific EcoRisk

Analysis ID: 04-9466-2046 Endpoint: Germination Rate CETIS Version: CETISv1.8.7
 Analyzed: 23 Aug-16 17:17 Analysis: Parametric-Two Sample Official Results: Yes

Data Transform	Zeta	Alt Hyp	Trials	Seed	PMSD	Test Result
Angular (Corrected)	NA	C > T	NA	NA	6.41%	Passes germination rate

Equal Variance t Two-Sample Test

Control	vs Control	Test Stat	Critical	MSD	DF	P-Value	P-Type	Decision(α:5%)
Lab Water Control	Brine Control	-1.14	1.86	0.063	8	0.8570	CDF	Non-Significant Effect

ANOVA Table

Source	Sum Squares	Mean Square	DF	F Stat	P-Value	Decision(α:5%)
Between	0.003738099	0.003738099	1	1.31	0.2860	Non-Significant Effect
Error	0.02287684	0.002859605	8			
Total	0.02661494		9			

Distributional Tests

Attribute	Test	Test Stat	Critical	P-Value	Decision(α:1%)
Variances	Variance Ratio F	1.04	23.2	0.9688	Equal Variances
Distribution	Shapiro-Wilk W Normality	0.946	0.741	0.6169	Normal Distribution

Germination Rate Summary

C-%	Control Type	Count	Mean	95% LCL	95% UCL	Median	Min	Max	Std Err	CV%	%Effect
0	Lab Water Contr	5	0.798	0.745	0.851	0.8	0.74	0.86	0.0191	5.35%	0.0%
0	Brine Control	5	0.828	0.778	0.878	0.83	0.77	0.87	0.018	4.86%	-3.76%

Angular (Corrected) Transformed Summary

C-%	Control Type	Count	Mean	95% LCL	95% UCL	Median	Min	Max	Std Err	CV%	%Effect
0	Lab Water Cont	5	1.11	1.04	1.17	1.11	1.04	1.19	0.0242	4.88%	0.0%
0	Brine Control	5	1.15	1.08	1.21	1.15	1.07	1.2	0.0237	4.62%	-3.49%

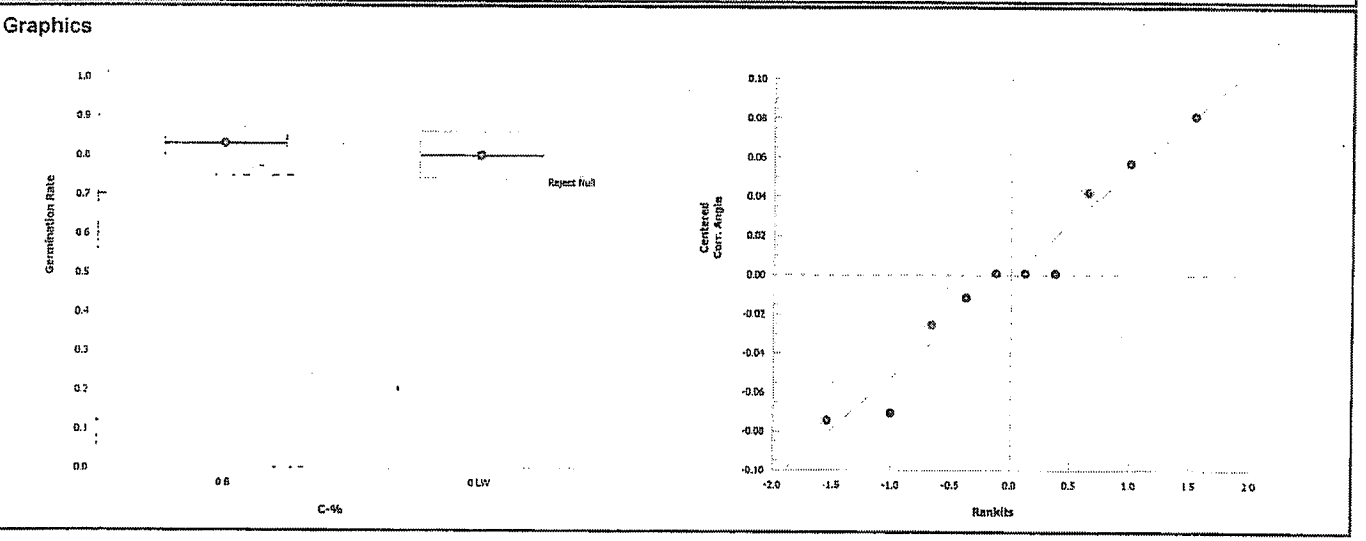

CETIS Analytical Report

Report Date: 23 Aug-16 17:17 (p 5 of 5)
 Test Code: 69320 | 14-9419-5486

Macrocystis Germination and Growth Test						Pacific EcoRisk	
Analysis ID: 14-6484-5550	Endpoint: Mean Length			CETIS Version: CETISv1.8.7			
Analyzed: 23 Aug-16 17:16	Analysis: Parametric-Two Sample			Official Results: Yes			

Data Transform	Zeta	Alt Hyp	Trials	Seed	PMSD	Test Result
Untransformed	NA	C > T	NA	NA	1.81%	Fails mean length

Equal Variance t Two-Sample Test									
Control	vs	Control	Test Stat	Critical	MSD	DF	P-Value	P-Type	Decision(α:5%)
Lab Water Control		Brine Control	3.48	1.86	0.294	8	0.0042	CDF	Significant Effect

ANOVA Table						
Source	Sum Squares	Mean Square	DF	F Stat	P-Value	Decision(α:5%)
Between	0.75625	0.75625	1	12.1	0.0083	Significant Effect
Error	0.5	0.0625	8			
Total	1.25625		9			

Distributional Tests					
Attribute	Test	Test Stat	Critical	P-Value	Decision(α:1%)
Variances	Variance Ratio F	1.86	23.2	0.5635	Equal Variances
Distribution	Shapiro-Wilk W Normality	0.952	0.741	0.6872	Normal Distribution

Mean Length Summary											
C-%	Control Type	Count	Mean	95% LCL	95% UCL	Median	Min	Max	Std Err	CV%	%Effect
0	Lab Water Contr	5	16.2	15.9	16.5	16.3	16	16.5	0.0935	1.29%	0.0%
0	Brine Control	5	15.7	15.3	16	15.8	15.3	16	0.127	1.82%	3.4%

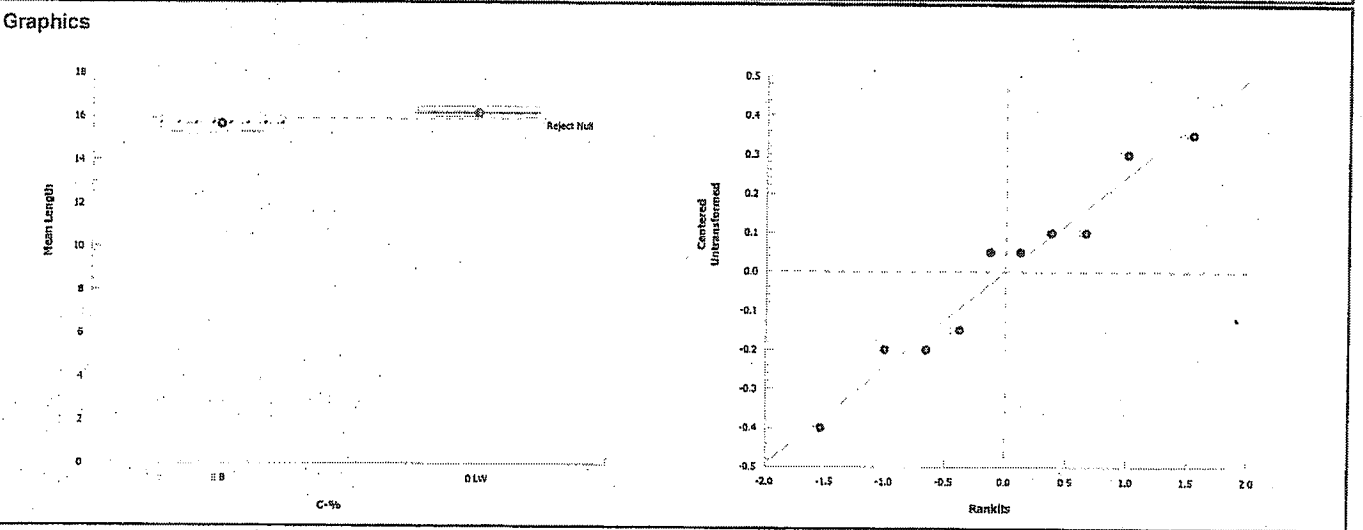

CETIS Analytical Report

Report Date: 24 Aug-16 14:04 (p 1 of 2)
 Test Code: 69320 | 14-9419-5486

Macrocystis Germination and Growth Test Pacific EcoRisk

Analysis ID: 10-7201-8125 Endpoint: Germination Rate CETIS Version: CETISv1.8.7
 Analyzed: 24 Aug-16 14:04 Analysis: Parametric Bioequivalence-Two Sample Official Results: Yes

Data Transform	Zeta	Alt Hyp	Trials	Seed	TST b	PMSD	Test Result
Angular (Corrected)	NA	C*b < T	NA	NA	0.75	9.45%	Passes germination rate

TST-Welch's t Test

Control	vs	C-%	Test Stat	Critical	MSD	DF	P-Value	P-Type	Decision(α:5%)
Lab Water Control		3.3*	5.46	2.02	0.090	5	0.0014	CDF	Non-Significant Effect

ANOVA Table

Source	Sum Squares	Mean Square	DF	F Stat	P-Value	Decision(α:5%)
Between	0.00252264	0.00252264	1	0.445	0.5234	Non-Significant Effect
Error	0.04532616	0.00566577	8			
Total	0.0478488		9			

Distributional Tests

Attribute	Test	Test Stat	Critical	P-Value	Decision(α:1%)
Variances	Variance Ratio F	2.88	23.2	0.3298	Equal Variances
Distribution	Shapiro-Wilk W Normality	0.92	0.741	0.3539	Normal Distribution

Germination Rate Summary

C-%	Control Type	Count	Mean	95% LCL	95% UCL	Median	Min	Max	Std Err	CV%	%Effect
0	Lab Water Contr	5	0.798	0.745	0.851	0.8	0.74	0.86	0.0191	5.35%	0.0%
3.3		5	0.77	0.671	0.869	0.8	0.64	0.83	0.0356	10.3%	3.51%

Angular (Corrected) Transformed Summary

C-%	Control Type	Count	Mean	95% LCL	95% UCL	Median	Min	Max	Std Err	CV%	%Effect
0	Lab Water Cont	5	1.11	1.04	1.17	1.11	1.04	1.19	0.0242	4.88%	0.0%
3.3		5	1.07	0.961	1.19	1.11	0.927	1.15	0.041	8.53%	2.87%

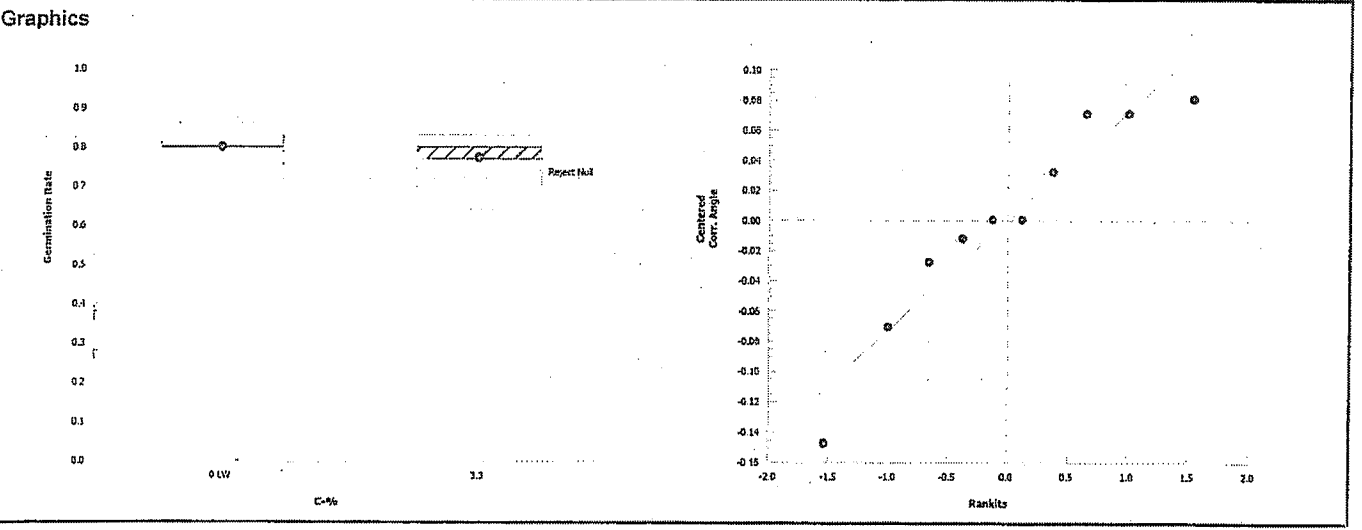

CETIS Analytical Report

Report Date: 24 Aug-16 14:05 (p 2 of 2)
 Test Code: 69320 | 14-9419-5486

Macrocyctis Germination and Growth Test Pacific EcoRisk

Analysis ID: 01-3402-4799 Endpoint: Mean Length CETIS Version: CETISv1.8.7
 Analyzed: 24 Aug-16 14:04 Analysis: Parametric Bioequivalence-Two Sample Official Results: Yes

Data Transform	Zeta	Alt Hyp	Trials	Seed	TST b	PMSD	Test Result
Untransformed	NA	C*b < T	NA	NA	0.75	3.32%	Passes mean length

TST-Welch's t Test

Control	vs	C-%	Test Stat	Critical	MSD	DF	P-Value	P-Type	Decision(α:5%)
Lab Water Control		3.3*	8.12	2.13	0.538	4	0.0006	CDF	Non-Significant Effect

ANOVA Table

Source	Sum Squares	Mean Square	DF	F Stat	P-Value	Decision(α:5%)
Between	10	10	1	59.3	<0.0001	Significant Effect
Error	1.35	0.16875	8			
Total	11.35		9			

Distributional Tests

Attribute	Test	Test Stat	Critical	P-Value	Decision(α:1%)
Variances	Variance Ratio F	6.71	23.2	0.0921	Equal Variances
Distribution	Shapiro-Wilk W Normality	0.912	0.741	0.2921	Normal Distribution

Mean Length Summary

C-%	Control Type	Count	Mean	95% LCL	95% UCL	Median	Min	Max	Std Err	CV%	%Effect
0	Lab Water Contr	5	16.2	15.9	16.5	16.3	16	16.5	0.0935	1.29%	0.0%
3.3		5	14.2	13.5	14.9	14.3	13.5	15	0.242	3.82%	12.3%

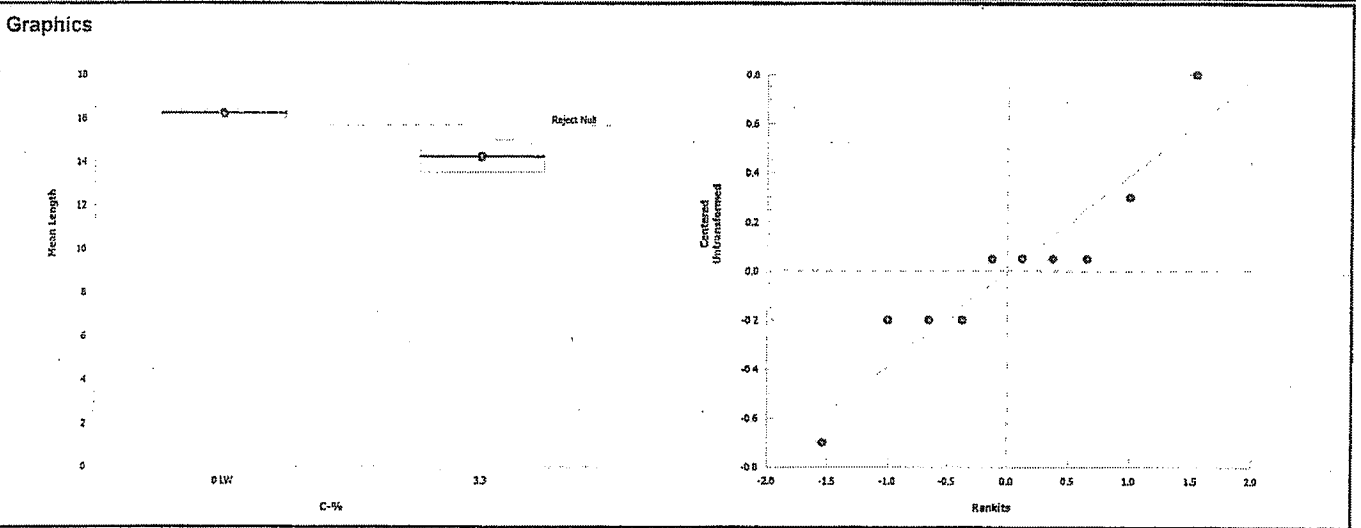

Kelp (*M. pyrifera*) Development Toxicity Test Water Chemistry Data

Client: Crescent City
 Test Material: Control Waters
 Test ID#: 69320 Project #: 26158
 Test Date: 8/17/16

Organism Log#: 9753 Age: N/A
 Organism Supplier: Gutoff
 Control/Diluent: Filtered Seawater

Sample Salinity adjusted with:

Day 0					
Treatment	Temperature (°C)	pH	D.O. (mg/L)	Salinity (ppt)	Signoff
Lab Water Control	15.9	7.31	7.8	32.4 32.4	Date & Inoculation Time: 8/17/16 / 1705
Brine Control	15.9	7.33	8.2	32.9	Solution Prep/Inoculation: JBL / JBL
Meter ID	48A	PH22	RD9	EC11	New WQ: A

Day 1					
Treatment	Temperature (°C)	pH	D.O. (mg/L)	Salinity (ppt)	Signoff
Lab Water Control	14.0				Date: 8/18/16
Brine Control	14.0				Old WQ: R
Meter ID	48A				

Day 2					
Treatment	Temperature (°C)	pH	D.O. (mg/L)	Salinity (ppt)	Signoff
Lab Water Control	14.4	7.88	7.6	32.9	Date: 8/19/16
Brine Control	14.4	7.87	7.7	35.0	Termination: DM
Meter ID	48A	PH22	RD11	EC11	Old WQ: DM

Kelp (*M. pyrifera*) Development Toxicity Test Water Chemistry Data

Client: Crescent City
 Test Material: Effluent
 Test ID#: 69320 Project #: 26158
 Test Date: 8/17/16 Randomization: _____
 Sample Salinity adjusted with : Hyper Saline Brine

Organism Log#: 9753 Age: N/A
 Organism Supplier: Gutoff
 Control/Diluent: 0.2 µm Filtered Seawater
 Light Intensity: 216.7

Day 0					
Treatment	Temperature (°C)	pH	D.O. (mg/L)	Salinity (ppt)	Signoff
Lab Control	15.9	7.31	7.8	32.4	Sample ID: 43851
0.8%	15.9	7.37	8.3	32.6	Test Solution Prep: JBL
1.6%	15.9	7.38	8.4	32.7	New WQ: UA
3.3%	15.9	7.41	8.5	32.7	Innoculation Date: 8/17/16
6.6%	15.9	7.42	8.5	32.8	Innoculation Time: 1705
13.2%	15.9	7.44	8.4	32.9	Innoculation Signoff: JBL
Meter ID	48A	pH 22	RD09	EC11	

Day 1					
Treatment	Temperature (°C)	pH	D.O. (mg/L)	Salinity (ppt)	Signoff
Lab Control	14.0				Date: 8/18/16
0.8%	14.0				Old WQ: Ze
1.6%	14.0				
3.3%	14.0				
6.6%	14.0				
13.2%	14.0				
Meter ID	48A				

Day 2					
Treatment	Temperature (°C)	pH	D.O. (mg/L)	Salinity (ppt)	Signoff
Lab Control	14.4	7.88	7.6	32.9	Termination Time: 1610
0.8%	14.4	7.82	7.6	33.3	Termination Signoff: DM
1.6%	14.4	7.84	7.6	33.9	Old WQ: DM
3.3%	14.4	7.85	7.6	34.3	
6.6%	14.4	7.87	7.7	34.3	
13.2%	14.4	7.88	7.7	34.9	
Meter ID	48A	PH22	RD11	EC11	

Kelp (*M. pyrifera*) Development Toxicity Test Data

Client: Crescent City Test Start Date: _____ Test End Date: _____ Enumeration Date: 2/22/16
 Test Material: Effluent Test ID #: 69360 Project #: 26158 Investigator: JL
 Control Medium: Filtered Seawater Sample salinity adjusted with: Hyper-Saline Brine Micrometer Conv. Factor: 2.5

		Germination		Length Measurements (in ocular micrometer units)											
Treatment	Rep	# Spores Germinated	# Spores not Germinated	L1	L2	L3	L4	L5	L6	L7	L8	L9	L10	MEAN	Corrected Mean Length (µm)
Lab Water Control	A	80	20	5	8	6	7	7	7	6	6	7	5	6.4	16
	B	74	26	7	5	8	9	6	5	5	6	6	7	6.4	16
	C	86	14	7	5	9	7	5	8	7	5	6	7	6.6	16.5
	D	79	21	6	8	7	6	8	6	5	6	7	6	6.5	16.25
	E	80	20	6	5	6	7	7	7	7	7	7	6	6.5	16.25
Brine Control	A	87	13	7	7	6	5	7	6	6	6	6	7	6.3	15.75
	B	83	17	5	7	6	7	5	6	6	6	7	6	6.1	15.25
	C	81	19	6	5	6	9	7	5	6	7	5	6	6.2	15.5
	D	86	14	5	7	6	6	9	8	7	5	5	6	6.4	16
	E	77	23	6	6	7	8	6	5	6	7	6	6	6.3	15.75

Kelp (*M. pyrifera*) Development Toxicity Test Data

Client: Crescent City Test Start Date: 8/17/16 Test End Date: _____ Enumeration Date: 8/22/16
 Test Material: Effluent Test ID #: 69320 Project #: 26158 Investigator: JL
 Control Medium: 0.2 µm filtered SW Sample salinity adjusted with: Hyper Saline Brine Micrometer Conv. Factor: 2.5

KCl (g/L)	Rep	Germination		Length Measurements (in ocular micrometer units)										MEAN	Corrected Mean Length (µm)
		# Spores Germinated	# Spores not Germinated	L1	L2	L3	L4	L5	L6	L7	L8	L9	L10		
Lab Control	A	80	20	5	8	6	7	7	7	6	6	7	5	6.4	16
	B	74	26	7	5	8	9	6	5	5	6	6	7	6.4	16
	C	86	14	7	5	9	7	5	8	7	5	6	7	6.6	16.5
	D	79	21	6	8	7	6	8	6	5	6	7	6	6.5	16.25
	E	80	20	6	5	6	7	7	7	7	7	7	6	6.5	16.25
0.8%	A	84	16	5	6	6	6	6	6	5	6	7	7	6	15
	B	75	25	6	5	7	7	6	7	5	6	6	7	6.2	15.5
	C	77	23	6	5	5	7	7	5	5	7	6	7	6	15
	D	87	13	6	6	5	6	5	5	6	6	6	7	5.8	14.5
	E	81	19	6	7	7	7	8	7	5	5	6	5	6.3	15.75
1.6%	A	77	23	5	5	6	6	5	6	7	5	5	6	5.6	14
	B	90	10	5	5	6	7	6	7	5	7	5	6	5.9	14.75
	C	80	20	5	5	6	7	6	6	6	5	6	5	5.7	14.25
	D	73	27	9	5	5	5	8	5	7	7	5	6	6.2	15.5
	E	81	19	5	5	6	5	7	5	7	6	6	6	5.8	14.5
3.3%	A	83	17	6	5	7	7	7	5	5	6	7	5	6	15
	B	80	20	5	5	5	6	4	5	5	6	6	7	5.4	13.5
	C	64	36	5	6	6	5	6	5	7	7	5	5	5.7	14.25
	D	83	17	5	5	5	6	6	6	6	7	5	5	5.6	14
	E	75	25	5	5	6	5	6	6	5	6	5	8	5.7	14.25
6.6%	A	72	28	4	6	4	5	5	5	5	5	5	7	5.1	12.75
	B	78	22	5	5	6	7	4	6	4	6	5	5	5.3	13.25
	C	78	22	5	5	6	5	4	6	5	6	6	6	5.4	13.5
	D	73	27	6	5	4	7	5	6	5	5	6	6	5.5	13.75
	E	82	18	5	5	5	6	7	6	5	5	4	4	5.2	13
13.2%	A	74	26	4	5	4	5	5	5	6	5	4	6	4.9	12.25
	B	75	25	6	5	7	6	5	6	4	5	4	4	5.2	13
	C	83	17	5	7	5	4	5	5	4	6	5	5	5.1	12.75
	D	74	26	3	6	4	6	4	4	6	4	5	6	4.8	12
	E	76	24	6	5	4	4	5	4	5	6	5	5	4.9	12.25

Appendix C

Test Data and Summary of Statistics for the Reference Toxicant Evaluation of the Giant Kelp *Macrocystis pyrifera*

CETIS Summary Report

Report Date: 24 Aug-16 13:19 (p 1 of 2)
 Test Code: 69134 | 18-5238-8317

Macrocystis Germination and Growth Test Pacific EcoRisk

Batch ID: 04-2022-0171	Test Type: Growth-Germination	Analyst: Stevi Vasquez
Start Date: 17 Aug-16 17:10	Protocol: EPA/600/R-95/136 (1995)	Diluent: Filtered Seawater
Ending Date: 19 Aug-16 16:15	Species: Macrocystis pyrifera	Brine: Not Applicable
Duration: 47h	Source: Gutoff	Age: N/A

Sample ID: 16-0759-9153	Code: KCI	Client: Reference Toxicant
Sample Date: 17 Aug-16 17:10	Material: Potassium chloride	Project: 26140
Receive Date: 17 Aug-16 17:10	Source: Reference Toxicant	
Sample Age: NA (15.9 °C)	Station: In House	

Comparison Summary

Analysis ID	Endpoint	NOEL	LOEL	TOEL	PMSD	TU	Method
02-7780-6891	Germination Rate	4	8	5.657	8.85%		Steel Many-One Rank Sum Test
18-7463-2988	Mean Length	4	8	5.657	7.69%		Dunnett Multiple Comparison Test

Point Estimate Summary

Analysis ID	Endpoint	Level	g/L	95% LCL	95% UCL	TU	Method
02-1528-3396	Germination Rate	EC5	3.82	3.06	4.45		Linear Regression (MLE)
		EC10	4.35	3.59	4.98		
		EC15	4.75	4	5.37		
		EC20	5.1	4.35	5.7		
		EC25	5.41	4.68	6.01		
		EC40	6.3	5.62	6.86		
08-8084-7524	Mean Length	IC5	5	4	5.51		Linear Interpolation (ICPIN)
		IC10	6.11	5.17	7.22		
		IC15	7.22	6.25	8.99		
		IC20	9.5	6.62	13.5		
		IC25	12.1	9.24	12.5		
		IC40	12.9	12.5	13.2		
IC50	13.4	13.1	13.7				

Germination Rate Summary

C-g/L	Control Type	Count	Mean	95% LCL	95% UCL	Min	Max	Std Err	Std Dev	CV%	%Effect
0	Lab Water Contr	5	0.83	0.801	0.859	0.81	0.87	0.0105	0.0235	2.83%	0.0%
2		5	0.842	0.801	0.883	0.8	0.89	0.0146	0.0327	3.88%	-1.45%
4		5	0.858	0.848	0.868	0.85	0.87	0.00374	0.00837	0.98%	-3.37%
8		5	0.208	0.0937	0.322	0.08	0.33	0.0412	0.092	44.2%	74.9%
12		5	0.104	0.0682	0.14	0.08	0.14	0.0129	0.0288	27.7%	87.5%
16		5	0	0	0	0	0	0	0		100.0%
32		5	0	0	0	0	0	0	0		100.0%

Mean Length Summary

C-g/L	Control Type	Count	Mean	95% LCL	95% UCL	Min	Max	Std Err	Std Dev	CV%	%Effect
0	Lab Water Contr	5	15.5	14.8	16.2	14.8	16	0.242	0.54	3.49%	0.0%
2		5	15.6	14.7	16.6	14.8	16.8	0.347	0.777	4.97%	-1.03%
4		5	15.5	14.9	16.1	14.8	16	0.208	0.466	3.01%	0.0%
8		5	12.7	11.7	13.7	11.8	14	0.368	0.823	6.49%	18.1%
12		5	12.1	10.5	13.6	10.5	13.3	0.556	1.24	10.3%	22.1%
16		5	0	0	0	0	0	0	0		100.0%
32		5	0	0	0	0	0	0	0		100.0%

CETIS Summary Report

Report Date: 24 Aug-16 13:19 (p 2 of 2)
 Test Code: 69134 | 18-5238-8317

Macrocystis Germination and Growth Test							Pacific EcoRisk
Germination Rate Detail							
C-g/L	Control Type	Rep 1	Rep 2	Rep 3	Rep 4	Rep 5	
0	Lab Water Contr	0.81	0.87	0.82	0.82	0.83	
2		0.84	0.8	0.83	0.85	0.89	
4		0.86	0.86	0.85	0.87	0.85	
8		0.33	0.25	0.18	0.2	0.08	
12		0.13	0.08	0.08	0.14	0.09	
16		0	0	0	0	0	
32		0	0	0	0	0	
Mean Length Detail							
C-g/L	Control Type	Rep 1	Rep 2	Rep 3	Rep 4	Rep 5	
0	Lab Water Contr	14.8	16	15	15.8	15.8	
2		15.3	16.8	16	15.3	14.8	
4		15.8	16	15.3	14.8	15.5	
8		14	12.8	11.8	12.5	12.3	
12		10.5	12.5	13.3	13	11	
16		0	0	0	0	0	
32		0	0	0	0	0	
Germination Rate Binomials							
C-g/L	Control Type	Rep 1	Rep 2	Rep 3	Rep 4	Rep 5	
0	Lab Water Contr	81/100	87/100	82/100	82/100	83/100	
2		84/100	80/100	83/100	85/100	89/100	
4		86/100	86/100	85/100	87/100	85/100	
8		33/100	25/100	18/100	20/100	8/100	
12		13/100	8/100	8/100	14/100	9/100	
16		0/100	0/100	0/100	0/100	0/100	
32		0/100	0/100	0/100	0/100	0/100	

Macrocystis Germination and Growth Test

Pacific EcoRisk

Test Type: Growth-Germination

Organism: Macrocystis pyrifera (Giant Kelp)

Material: Potassium chloride

Protocol: EPA/600/R-95/136 (1995)

Endpoint: Germination Rate

Source: Reference Toxicant-REF

Macrocystis Germination and Growth Test

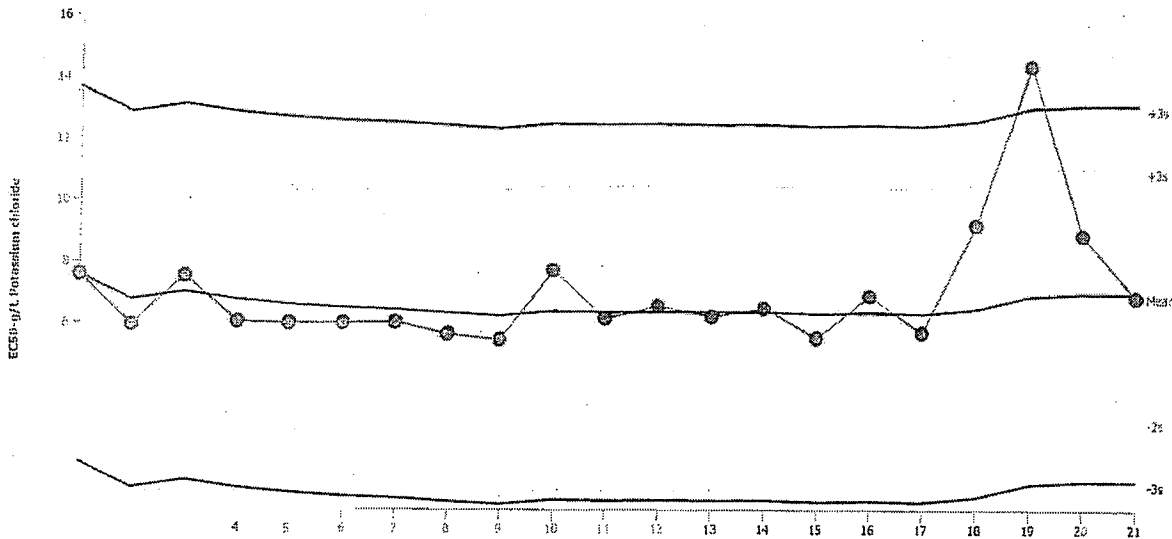

Mean: 7.032 Count: 20 -2s Warning Limit: 2.968 -3s Action Limit: 0.9361
 Sigma: 2.032 CV: 28.90% +2s Warning Limit: 11.1 +3s Action Limit: 13.13

Quality Control Data

Point	Year	Month	Day	Time	QC Data	Delta	Sigma	Warning	Action	Test ID	Analysis ID
1	2014	Sep	18	15:57	7.606	0.574	0.2825			21-1340-6125	15-7291-7988
2			26	16:16	5.97	-1.062	-0.5228			10-1363-0372	11-5475-5741
3		Nov	14	14:42	7.556	0.5241	0.2579			05-8406-7629	08-9262-7840
4		Dec	11	17:47	6.069	-0.9632	-0.474			06-3674-9917	17-6928-0916
5	2015	Feb	4	15:12	6.021	-1.011	-0.4977			01-8953-9417	04-4584-8875
6			11	17:05	6.037	-0.9951	-0.4897			00-6859-6632	11-0740-3478
7		Mar	26	15:27	6.063	-0.9694	-0.477			14-4111-2465	03-1249-4814
8		Apr	10	15:00	5.674	-1.358	-0.6682			00-4546-7083	00-3592-2978
9			21	16:05	5.495	-1.537	-0.7563			03-8790-5000	05-3114-2687
10		Aug	19	16:05	7.757	0.7248	0.3567			00-8038-7597	06-3517-6896
11		Sep	17	16:29	6.2	-0.8321	-0.4095			04-3239-9760	11-0821-6592
12			29	15:19	6.603	-0.4291	-0.2112			18-0573-6207	18-1298-6802
13		Oct	14	16:20	6.263	-0.7687	-0.3783			17-5745-2582	12-8310-9011
14	2016	Feb	11	17:57	6.538	-0.4941	-0.2432			02-2002-4116	14-7721-4486
15			24	15:16	5.567	-1.465	-0.7211			14-6182-9064	09-1770-7016
16		Mar	24	15:38	6.945	-0.0868	-0.04272			13-0997-3236	10-5433-4188
17		May	11	16:59	5.746	-1.286	-0.6327			06-3859-4233	17-4202-2030
18			17	16:15	9.231	2.199	1.082			06-9642-0474	03-5224-9353
19		Jun	8	17:25	14.4	7.368	3.626	(+)	(+)	17-1352-1021	14-8324-4382
20		Jul	20	16:10	8.902	1.87	0.9202			17-7162-8612	12-4837-0994
21		Aug	17	17:10	6.899	-0.1331	-0.0655			18-5238-8317	02-1528-3396

Macrocystis Germination and Growth Test

Pacific EcoRisk

Test Type: Growth-Germination Organism: Macrocystis pyrifera (Giant Kelp) Material: Potassium chloride
 Protocol: EPA/600/R-95/136 (1995) Endpoint: Mean Length Source: Reference Toxicant-REF

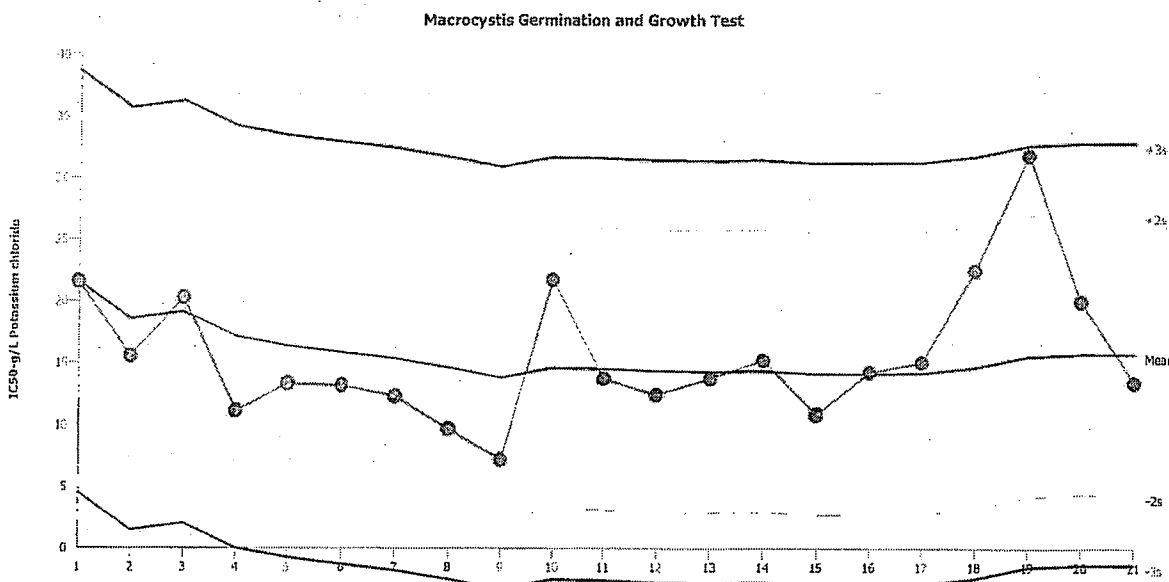

Mean: 15.79 Count: 20 -2s Warning Limit: 4.379 -3s Action Limit: -1.326
 Sigma: 5.705 CV: 36.10% +2s Warning Limit: 27.2 +3s Action Limit: 32.9

Quality Control Data

Point	Year	Month	Day	Time	QC Data	Delta	Sigma	Warning	Action	Test ID	Analysis ID
1	2014	Sep	18	15:57	21.64	5.847	1.025			21-1340-6125	14-8451-0531
2			26	16:16	15.56	-0.2293	-0.04019			10-1363-0372	09-2501-0092
3		Nov	14	14:42	20.34	4.546	0.7968			05-8406-7629	14-0145-0588
4		Dec	11	17:47	11.11	-4.68	-0.8203			06-3674-9917	03-1545-1560
5	2015	Feb	4	15:12	13.34	-2.451	-0.4296			01-8953-9417	15-3725-7494
6			11	17:05	13.18	-2.606	-0.4568			00-6859-6632	05-1990-8292
7		Mar	26	15:27	12.3	-3.491	-0.612			14-4111-2465	01-6620-2006
8		Apr	10	15:00	9.655	-6.135	-1.075			00-4546-7083	13-6601-4182
9			21	16:05	7.205	-8.585	-1.505			03-8790-5000	07-1454-1082
10		Aug	19	16:05	21.75	5.962	1.045			00-8038-7597	02-4787-3597
11		Sep	17	16:29	13.73	-2.06	-0.3611			04-3239-9760	02-3980-1049
12			29	15:19	12.4	-3.392	-0.5945			18-0573-6207	13-4305-3927
13		Oct	14	16:20	13.76	-2.034	-0.3565			17-5745-2582	04-0174-8566
14	2016	Feb	11	17:57	15.24	-0.5512	-0.09662			02-2002-4116	12-7156-0426
15			24	15:16	10.82	-4.972	-0.8715			14-6182-9064	03-9577-8450
16		Mar	24	15:38	14.28	-1.514	-0.2654			13-0997-3236	02-9744-4108
17		May	11	16:59	15.07	-0.7196	-0.1261			06-3859-4233	01-7311-8088
18			17	16:15	22.5	6.709	1.176			06-9642-0474	15-6784-5098
19		Jun	8	17:25	31.88	16.09	2.821	(+)		17-1352-1021	02-1666-9355
20		Jul	20	16:10	20.03	4.239	0.743			17-7162-8612	07-8845-1726
21		Aug	17	17:10	13.42	-2.37	-0.4155			18-5238-8317	08-8084-7524

Kelp (*M. pyrifera*) Development Reference Toxicant Test Water Chemistry Data

Client: Reference Toxicant
 Test Material: Potassium chloride
 Test ID#: 69134 Project #: 26140
 Test Date: 8/17/16 Randomization: N/A

Organism Log#: 9753 Age: N/A
 Organism Supplier: Gutloff
 Control/Diluent: Filtered Seawater
 Light Intensity: 197.25

Day 0					
Treatment (g KCl/L)	Temperature (°C)	pH	D.O. (mg/L)	Salinity (ppt)	Signoff
Lab Water Control	15.9	7.00	7.8	31.6 32.1	Test Solution Prep JBL
2	15.9	7.28	8.1	34.0	New WQ: YJ
4	15.9	7.34	8.5	35.9	Inoculation Date 8/17/16
8	15.9	7.40	8.6	39.9	Inoculation Time 17:10
12	15.9	7.48	8.6	44.4	Inoculation Signoff: JBL
16	15.9	7.51	8.4	48.8	
32	15.9	7.54	8.7	65.3	
Meter ID	48A	PH15	RD12	EC09	

Day 1					
Treatment (g KCl/L)	Temperature (°C)	pH	D.O. (mg/L)	Salinity (ppt)	Signoff
Lab Water Control	14.0				Date: 8/18/16
2	14.0				Old WQ: <u>2</u>
4	14.0				
8	14.0				
12	14.0				
16	14.0				
32	14.0				
Meter ID	48A				

Day 2					
Treatment (g KCl/L)	Temperature (°C)	pH	D.O. (mg/L)	Salinity (ppt)	Signoff
Lab Water Control	14.4	7.99	7.5	34.7	Termination Date 8/19/16
2	14.4	7.98	7.6	35.4	Termination Time 16:15
4	14.4	7.96	7.7	37.0	Termination Signoff DM
8	14.4	7.95	7.7	41.2	Old WQ: DM
12	14.4	7.93	7.7	46.6	
16	14.4	7.93	7.7	49.9	
32	14.4	7.93	7.7	65.4	
Meter ID	48A	PH22	RD11	EC11	

Kelp (*M. pyrifera*) Development Toxicity Test Data

Client: Reference Toxicant Test Start Date: 8/17/16 Test End Date: 8/19/16 Enumeration Date: 8/23/16
 Test Material: Potassium Chloride Test ID #: 69134 Project #: 26140 Investigator: JL
 Control Medium: Filtered Seawater Micrometer Conv. Factor: 2.5

KCl (g/L)	Rep	Germination		Length Measurements (in ocular micrometer units)										MEAN	Corrected Mean Length (µm)
		# Spores Germinated	# Spores not Germinated	L1	L2	L3	L4	L5	L6	L7	L8	L9	L10		
Lab Water Control	A	81	19	5	6	7	6	6	6	5	7	6	5	5.9	14.8
	B	87	13	6	6	7	6	7	5	7	6	7	7	6.4	16.0
	C	82	18	6	6	7	8	5	5	6	6	5	6	6.0	15.0
	D	82	18	8	5	6	7	7	6	6	5	6	7	6.3	15.8
	E	83	17	5	5	9	7	7	6	7	6	5	6	6.2	15.8
2	A	84	16	7	5	8	6	5	7	7	6	5	5	6.1	15.3
	B	80	20	6	7	8	7	5	8	8	7	5	6	6.7	16.8
	C	83	17	6	6	7	7	7	6	9	6	8	5	6.4	16.0
	D	85	15	6	7	7	5	5	7	7	5	6	6	6.1	15.3
	E	89	11	7	7	5	7	5	6	5	6	6	5	5.9	14.8
4	A	86	14	6	8	5	6	5	7	6	5	7	8	6.3	15.8
	B	86	14	6	6	7	6	7	7	7	6	7	5	6.4	16.0
	C	85	15	8	8	6	6	6	5	5	6	6	5	6.1	15.3
	D	87	13	6	6	7	5	6	5	7	5	5	7	5.9	14.8
	E	85	15	6	7	8	5	5	5	5	7	6	8	6.2	15.5
8	A	33	67	6	5	5	6	5	6	5	7	5	6	5.6	14.0
	B	25	75	6	6	6	5	5	5	5	4	5	4	5.1	12.8
	C	18	82	3	5	3	6	5	4	6	5	5	5	4.7	11.8
	D	20	80	3	7	7	4	5	5	3	5	4	7	5.0	12.5
	E	8	92	5	5	6	6	5	5	6	3	5	3	4.9	12.3
12	A	13	87	3	5	3	4	4	4	4	5	5	5	4.2	10.5
	B	8	92	5	5	6	5	4	5	5	5	5	5	5.0	12.5
	C	8	92	5	5	6	5	6	5	5	5	6	5	5.3	13.3
	D	14	86	7	5	6	6	5	5	3	6	4	5	5.2	13.0
	E	9	91	3	5	3	4	6	5	4	4	5	5	4.4	11.0
16	A	0	100	-	-	-	-	-	-	-	-	-	-	-	-
	B	0	100	-	-	-	-	-	-	-	-	-	-	-	-
	C	0	100	-	-	-	-	-	-	-	-	-	-	-	-
	D	0	100	-	-	-	-	-	-	-	-	-	-	-	-
	E	0	100	-	-	-	-	-	-	-	-	-	-	-	-
32	A	0	100	-	-	-	-	-	-	-	-	-	-	-	-
	B	0	100	-	-	-	-	-	-	-	-	-	-	-	-
	C	0	100	-	-	-	-	-	-	-	-	-	-	-	-
	D	0	100	-	-	-	-	-	-	-	-	-	-	-	-
	E	0	100	-	-	-	-	-	-	-	-	-	-	-	-

City of Crescent City

My Account (1934021120) **myfacilitydude** apps

- Quick Links - Logout



Work Order My Requests My Settings

■ HELP

My Requests Shortcuts

My Work Order Requests

Note: Once the request is assigned to someone for approval, you no longer can edit the request. You can click on the current assigned person name to send email and request changes on your request.
 Search for "

Request Totals
 1 New Request
 2 Work In Progress
 23 Complete

Limit list to my requests only: Yes No

Search this results for: Show All

11 - 20 of total 26 listed

◀ Previous 10 Next 10 ▶

Status	Location	Action Taken	Req. Completion
Area	Priority	Assigned To	Complete Date
Area Number	Bldg./Unit Description	Request Date	
		Type	
Complete	Facilities High Lab 2777 TEST FOR CRAFT ROUTING	No Action Note Dan Borges 8/5/2015 Electrical	8/5/2015 8/10/2015 9:31:01 AM
Complete	Lab High 2775 Water leaking through Roof Tile again-another puddle this morning.	Jon to take a look.9/15/15 DB Jon cleaned out pan, drain and now seems to be ok.9/16/15 DB Jonathan Blue 8/5/2015 Facilities Maintenance	8/7/2015 9/16/2015 3:31:58 PM
Complete	Lab Low 2609 The vacuum Air Pump needs servicing. At a minimum it is past due for a filter change out and at this time has potentially pulled water into the line.	Changed filters, needs to be ran for 10-15 min straight for a couple of days to get water out of line. DB/JB Tom Romesberg 7/21/2015 Facilities Maintenance	9/30/2015 12/11/2015 8:47:35 AM
Complete	Lab Medium 2473 Low water light keeps coming on inappropriately on the autoclave: needs maintenance and check out.	Lab to clean scale from Autoclave. Will let us know if it continues. DB 7/13 Dan Borges 7/9/2015 Utilities	7/24/2015 7/15/2015 11:25:24 AM
Complete	Lab High 2454 Ceiling Tile soaked and on floor: locate source of water and replace tile. Follow up: water on floor this afternoon... will verify status tomorrow.	Drain line for HVAC was plugged and over flowing drip pan. Replace tile in roof. Lab to lets us know if it continues. Dan Borges 7/7/2015 Utilities	7/8/2015 7/9/2015 5:20:20 PM
Complete	Lab High 2314 Drying Oven # 2 wont heat: burned out element?? High Priority Repair!!!	tested relay. needs to be replaced, part to be ordered.DB replacement part due in on 7/13. DB Part was back ordered and now due in on 7/28. DB Installed new Thermo Link and Thermo Relay on 8/19. DB Dan Borges 6/19/2015 Utilities	6/22/2015 8/20/2015 7:41:34 AM
Complete	Lab Low 1989 Verify Fuse operation for "Coliform West" EP2A 32 and EP2A 24.	Checked GFI breakers, tested for power. All are work at this time. DB 7/13 Dan Borges 5/11/2015 Utilities	5/31/2015 7/15/2015 11:23:26 AM
Complete	Lab Low 1946 I need to schedule to have the DI pump removed from dishwasher 1.	Removed pump and bucket under sink, plumbed in the dishwasher line to the hot water ready for normal use. JB 5/5/16 Tom Romesberg 5/7/2015 Utilities	6/30/2015 5/5/2016 10:55:32 AM
Complete	Lab Low 1945 Need to schedule annual inspection of autoclave: no hurry.	Checked manual and found no annual maintenance other then cleaning and observing readings.9/16/15 DB Dan Borges 5/7/2015 Utilities	9/30/2015 9/16/2015 3:26:49 PM
Complete	Lab Low 1944 Need to order and replace faucet	Fernado has parts on hand. Tom Romesberg 5/7/2015	5/31/2015 7/9/2015 5:31:10 PM

gaskets: several are beginning to leak again. Utilities

◀ Previous 10 Next 10 ▶

Work Order		My Requests	My Settings
CIP: 24.216.248.146	Conditions Of Use	Privacy Policy	Security Statement
SID: MSB01	Help	Logout	
DID: 3	Need help? Call us 1-877-655-DUDE (3833)		
CUA: MSIE	Copyright © 1999-2015 FacilityDude.com, Inc. All Rights Reserved. Legal Stuff		



Sample Tracking

All Incomplete Analyses

CCWQL
01-Sep-16

Warning	SampleID	Status	Project	Who	Collected Analysis	Expires
EXP	160801J002	Normal	WWTP Daily	DA	8/1/2016 Settleable Solids	8/8/2016
EXP	160801J002	Normal	WWTP Daily	DA	8/1/2016 Temperature	8/1/2016
EXP	160801J003	Normal	WWTP Daily	DA	8/1/2016 Settleable Solids	8/8/2016
EXP	160801J003	Normal	WWTP Daily	DA	8/1/2016 Temperature	8/1/2016
EXP	160801J004	Normal	Filtrate MOS	DA	8/1/2016 % UVT	8/2/2016
EXP	160801J004	Normal	Filtrate MOS	DA	8/1/2016 Temperature	8/1/2016
EXP	160801J005	Normal	AEROBIC BASIN	DA	8/1/2016 Temperature	8/1/2016
EXP	160801J006	Normal	Primary Effluent grab	DA	8/1/2016 Temperature	8/1/2016
DUE	160801O005	Normal	CC Drinking Water Field Data	WF	8/1/2016 FLOW	11/9/2016
EXP	160802I002	Normal	WWTP Daily	AG	8/2/2016 Settleable Solids	8/9/2016
EXP	160802I002	Normal	WWTP Daily	AG	8/2/2016 Temperature	8/2/2016
EXP	160802I003	Normal	WWTP Daily	EM	8/2/2016 Settleable Solids	8/9/2016
EXP	160802I003	Normal	WWTP Daily	EM	8/2/2016 Temperature	8/2/2016
EXP	160802I004	Normal	Filtrate MOS	AG	8/2/2016 % UVT	8/3/2016
EXP	160802I004	Normal	Filtrate MOS	AG	8/2/2016 Temperature	8/2/2016
EXP	160802I005	Normal	AEROBIC BASIN	EM	8/2/2016 Temperature	8/2/2016
EXP	160802I006	Normal	Primary Effluent grab	EM	8/2/2016 Temperature	8/2/2016
DUE	160802O005	Normal	CC Drinking Water Field Data	WF	8/2/2016 FLOW	11/10/2016
EXP	160802O009	Normal	Contact Tank	EM	8/2/2016 Total Residual Chlorine	8/2/2016
EXP	160803J002	Normal	WWTP Daily	EM	8/3/2016 Settleable Solids	8/10/2016
EXP	160803J002	Normal	WWTP Daily	EM	8/3/2016 Temperature	8/3/2016
EXP	160803J003	Normal	WWTP Daily	EM	8/3/2016 Settleable Solids	8/10/2016
EXP	160803J003	Normal	WWTP Daily	EM	8/3/2016 Temperature	8/3/2016
EXP	160803J004	Normal	Filtrate MOS	EM	8/3/2016 % UVT	8/4/2016
EXP	160803J004	Normal	Filtrate MOS	EM	8/3/2016 Temperature	8/3/2016
EXP	160803J005	Normal	AEROBIC BASIN	AG	8/3/2016 Temperature	8/3/2016
EXP	160803J006	Normal	Primary Effluent grab	EM	8/3/2016 Temperature	8/3/2016
DUE	160803L005	Normal	CC Drinking Water Field Data	TW	8/3/2016 FLOW	11/11/2016
EXP	160804N002	Normal	WWTP Daily	EM	8/4/2016 Settleable Solids	8/11/2016
EXP	160804N002	Normal	WWTP Daily	EM	8/4/2016 Temperature	8/4/2016
EXP	160804N003	Normal	WWTP Daily	EM	8/4/2016 Settleable Solids	8/11/2016
EXP	160804N003	Normal	WWTP Daily	EM	8/4/2016 Temperature	8/4/2016
EXP	160804N004	Normal	Filtrate MOS	EM	8/4/2016 % UVT	8/5/2016
EXP	160804N004	Normal	Filtrate MOS	EM	8/4/2016 Temperature	8/4/2016
EXP	160804N005	Normal	AEROBIC BASIN	AG	8/4/2016 Temperature	8/4/2016
EXP	160804N006	Normal	Primary Effluent grab	EM	8/4/2016 Temperature	8/4/2016
DUE	160804N013	Normal	CC Drinking Water Field Data	WF	8/4/2016 FLOW	11/12/2016
EXP	160805O002	Normal	WWTP Daily	EM	8/5/2016 Settleable Solids	8/12/2016
EXP	160805O002	Normal	WWTP Daily	EM	8/5/2016 Temperature	8/5/2016
EXP	160805O003	Normal	WWTP Daily	EM	8/5/2016 Settleable Solids	8/12/2016
EXP	160805O003	Normal	WWTP Daily	EM	8/5/2016 Temperature	8/5/2016
EXP	160805O004	Normal	Filtrate MOS	EM	8/5/2016 % UVT	8/6/2016
EXP	160805O004	Normal	Filtrate MOS	EM	8/5/2016 Temperature	8/5/2016
EXP	160805O005	Normal	AEROBIC BASIN	AG	8/5/2016 Temperature	8/5/2016



Sample Tracking

All Incomplete Analyses

CCWQL
01-Sep-16

Warning	SampleID	Status	Project	Who	Collected Analysis	Expires
EXP	160805O006	Normal	Primary Effluent grab	EM	8/5/2016 Temperature	8/5/2016
EXP	160805O010	Normal	Rumiano Weekly	EM	8/5/2016 Settleable Solids	8/12/2016
DUE	160805O015	Normal	CC Drinking Water Field Data	WF	8/5/2016 FLOW	11/13/2016
EXP	160806J002	Normal	WWTP Daily	EM	8/6/2016 Settleable Solids	8/13/2016
EXP	160806J002	Normal	WWTP Daily	EM	8/6/2016 Temperature	8/6/2016
EXP	160806J003	Normal	WWTP Daily	EM	8/6/2016 Settleable Solids	8/13/2016
EXP	160806J003	Normal	WWTP Daily	EM	8/6/2016 Temperature	8/6/2016
EXP	160806J004	Normal	Filtrate MOS	EM	8/6/2016 % UVT	8/7/2016
EXP	160806J004	Normal	Filtrate MOS	EM	8/6/2016 Temperature	8/6/2016
EXP	160806J005	Normal	AEROBIC BASIN	EM	8/6/2016 Temperature	8/6/2016
EXP	160806J006	Normal	Primary Effluent grab	EM	8/6/2016 Temperature	8/6/2016
DUE	160806N005	Normal	CC Drinking Water Field Data	RT	8/6/2016 FLOW	11/14/2016
EXP	160807J002	Normal	WWTP Daily	DA	8/7/2016 Settleable Solids	8/14/2016
EXP	160807J002	Normal	WWTP Daily	DA	8/7/2016 Temperature	8/7/2016
EXP	160807J003	Normal	WWTP Daily	DA	8/7/2016 Settleable Solids	8/14/2016
EXP	160807J003	Normal	WWTP Daily	DA	8/7/2016 Temperature	8/7/2016
EXP	160807J004	Normal	Filtrate MOS	DA	8/7/2016 % UVT	8/8/2016
EXP	160807J004	Normal	Filtrate MOS	DA	8/7/2016 Temperature	8/7/2016
EXP	160807J005	Normal	AEROBIC BASIN	DA	8/7/2016 Temperature	8/7/2016
EXP	160807J006	Normal	Primary Effluent grab	DA	8/7/2016 Temperature	8/7/2016
DUE	160807N005	Normal	CC Drinking Water Field Data	RT	8/7/2016 FLOW	11/15/2016
EXP	160807135A	Normal	CC Drinking Water : PA	RT	8/7/2016 Escherichia.coli: P/A	8/8/2016
EXP	160807135A	Normal	CC Drinking Water : PA	RT	8/7/2016 Total Coliform: P/A	8/8/2016
EXP	160808P002	Normal	WWTP Daily	DA	8/8/2016 Settleable Solids	8/15/2016
EXP	160808P002	Normal	WWTP Daily	DA	8/8/2016 Temperature	8/8/2016
EXP	160808P003	Normal	WWTP Daily	DA	8/8/2016 Settleable Solids	8/15/2016
EXP	160808P003	Normal	WWTP Daily	DA	8/8/2016 Temperature	8/8/2016
EXP	160808P004	Normal	Filtrate MOS	DA	8/8/2016 % UVT	8/9/2016
EXP	160808P004	Normal	Filtrate MOS	DA	8/8/2016 Temperature	8/8/2016
EXP	160808P005	Normal	AEROBIC BASIN	DA	8/8/2016 Temperature	8/8/2016
EXP	160808P006	Normal	Primary Effluent grab	DA	8/8/2016 Temperature	8/8/2016
DUE	160808P011	Normal	CC Drinking Water Field Data	WF	8/8/2016 FLOW	11/16/2016
EXP	160809P002	Normal	WWTP Daily	EM	8/9/2016 Settleable Solids	8/16/2016
EXP	160809P002	Normal	WWTP Daily	EM	8/9/2016 Temperature	8/9/2016
EXP	160809P003	Normal	WWTP Daily	EM	8/9/2016 Settleable Solids	8/16/2016
EXP	160809P003	Normal	WWTP Daily	EM	8/9/2016 Temperature	8/9/2016
EXP	160809P004	Normal	Filtrate MOS	EM	8/9/2016 % UVT	8/10/2016
EXP	160809P004	Normal	Filtrate MOS	EM	8/9/2016 Temperature	8/9/2016
EXP	160809P005	Normal	AEROBIC BASIN	EM	8/9/2016 Temperature	8/9/2016
EXP	160809P006	Normal	Primary Effluent grab	EM	8/9/2016 Temperature	8/9/2016
DUE	160809Q007	Normal	CC Drinking Water Field Data	WF	8/9/2016 FLOW	11/17/2016
EXP	160810L002	Normal	WWTP Daily	JW	8/10/2016 Settleable Solids	8/17/2016
EXP	160810L002	Normal	WWTP Daily	JW	8/10/2016 Temperature	8/10/2016
EXP	160810L003	Normal	WWTP Daily	JW	8/10/2016 Settleable Solids	8/17/2016



Sample Tracking

All Incomplete Analyses

CCWQL
01-Sep-16

Warning	SampleID	Status	Project	Who	Collected Analysis	Expires
	EXP 160810L003	Normal	WWTP Daily	JW	8/10/2016 Temperature	8/10/2016
	EXP 160810L004	Normal	Filtrate MOS	JW	8/10/2016 % UVT	8/11/2016
	EXP 160810L004	Normal	Filtrate MOS	JW	8/10/2016 Temperature	8/10/2016
	EXP 160810L005	Normal	AEROBIC BASIN	JW	8/10/2016 Temperature	8/10/2016
	EXP 160810L006	Normal	Primary Effluent grab	JW	8/10/2016 Temperature	8/10/2016
	EXP 160810L011	Normal	Rumiano Weekly	EM	8/10/2016 Settleable Solids	8/17/2016
	DUE 160810M004	Normal	CC Drinking Water Field Data	WF	8/10/2016 Chlorine Probe	11/18/2016
	DUE 160810M005	Normal	CC Drinking Water Field Data	WF	8/10/2016 Chlorine Feed	11/18/2016
	DUE 160810M005	Normal	CC Drinking Water Field Data	WF	8/10/2016 Chlorine Probe	11/18/2016
	DUE 160810M005	Normal	CC Drinking Water Field Data	WF	8/10/2016 FLOW	11/18/2016
	EXP 1608110832	Normal	RAS	JW	8/10/2016 Total Suspended Solids	8/17/2016
	EXP 1608110832	Normal	RAS	JW	8/10/2016 Volatile Suspended Solids	8/17/2016
	EXP 160811J003	Normal	Contact Tank	EM	8/9/2016 Total Residual Chlorine	8/9/2016
	EXP 160811J005	Normal	WWTP Daily	EM	8/11/2016 Settleable Solids	8/18/2016
	EXP 160811J005	Normal	WWTP Daily	EM	8/11/2016 Temperature	8/11/2016
	EXP 160811J006	Normal	WWTP Daily	EM	8/11/2016 Settleable Solids	8/18/2016
	EXP 160811J006	Normal	WWTP Daily	EM	8/11/2016 Temperature	8/11/2016
	EXP 160811J007	Normal	Filtrate MOS	AG	8/11/2016 Temperature	8/11/2016
	EXP 160811J008	Normal	AEROBIC BASIN	AG	8/11/2016 Temperature	8/11/2016
	EXP 160811J009	Normal	Primary Effluent grab	AG	8/11/2016 Temperature	8/11/2016
	DUE 160811O009	Normal	CC Drinking Water Field Data	WF	8/11/2016 FLOW	11/19/2016
	EXP 160811P002	Normal	Contact Tank	EM	8/11/2016 Total Residual Chlorine	8/11/2016
	EXP 160812N002	Normal	WWTP Daily	EM	8/12/2016 Settleable Solids	8/19/2016
	EXP 160812N002	Normal	WWTP Daily	EM	8/12/2016 Temperature	8/12/2016
	EXP 160812N003	Normal	WWTP Daily	EM	8/12/2016 Settleable Solids	8/19/2016
	EXP 160812N003	Normal	WWTP Daily	EM	8/12/2016 Temperature	8/12/2016
	EXP 160812N004	Normal	Filtrate MOS	EM	8/12/2016 % UVT	8/13/2016
Warn	160812N004	Normal	Filtrate MOS	EM	8/12/2016 Alkalinity	9/9/2016
	EXP 160812N004	Normal	Filtrate MOS	EM	8/12/2016 Temperature	8/12/2016
Warn	160812N005	Normal	AEROBIC BASIN	EM	8/12/2016 Alkalinity	9/9/2016
	EXP 160812N005	Normal	AEROBIC BASIN	EM	8/12/2016 Temperature	8/12/2016
Warn	160812N006	Normal	Primary Effluent grab	EM	8/12/2016 Alkalinity	9/9/2016
	EXP 160812N006	Normal	Primary Effluent grab	EM	8/12/2016 Temperature	8/12/2016
	EXP 1608121305	Normal	Wastewater Non-Routine	PO	8/12/2016 Settleable Solids	8/19/2016
	DUE 160812N013	Normal	CC Drinking Water Field Data	WF	8/12/2016 FLOW	11/20/2016
	EXP 160813I002	Normal	WWTP Daily	EM	8/13/2016 Settleable Solids	8/20/2016
	EXP 160813I002	Normal	WWTP Daily	EM	8/13/2016 Temperature	8/13/2016
	EXP 160813I003	Normal	WWTP Daily	EM	8/13/2016 Settleable Solids	8/20/2016
	EXP 160813I003	Normal	WWTP Daily	EM	8/13/2016 Temperature	8/13/2016
	EXP 160813I004	Normal	Filtrate MOS	EM	8/13/2016 % UVT	8/14/2016
	EXP 160813I004	Normal	Filtrate MOS	EM	8/13/2016 Temperature	8/13/2016
	EXP 160813I005	Normal	AEROBIC BASIN	AG	8/13/2016 Temperature	8/13/2016
	EXP 160813I006	Normal	Primary Effluent grab	AG	8/13/2016 Temperature	8/13/2016
	DUE 160813O005	Normal	CC Drinking Water Field Data	TW	8/13/2016 FLOW	11/21/2016



Sample Tracking

All Incomplete Analyses

CCWQL
01-Sep-16

Warning	SampleID	Status	Project	Who	Collected Analysis	Expires
EXP	160814N002	Normal	WWTP Daily	DA	8/14/2016 Settleable Solids	8/21/2016
EXP	160814N002	Normal	WWTP Daily	DA	8/14/2016 Temperature	8/14/2016
EXP	160814N003	Normal	WWTP Daily	DA	8/14/2016 Settleable Solids	8/21/2016
EXP	160814N003	Normal	WWTP Daily	DA	8/14/2016 Temperature	8/14/2016
EXP	160814N004	Normal	Filtrate MOS	DA	8/14/2016 Temperature	8/14/2016
EXP	160814N005	Normal	AEROBIC BASIN	DA	8/14/2016 Temperature	8/14/2016
EXP	160814N006	Normal	Primary Effluent grab	DA	8/14/2016 Temperature	8/14/2016
DUE	160814N011	Normal	CC Drinking Water Field Data	RT	8/14/2016 FLOW	11/22/2016
EXP	160814I308	Normal	CC Drinking Water: non-routine	RT	8/14/2016 Send Out Testing	8/14/2016
EXP	160815N002	Normal	WWTP Daily	DA	8/15/2016 Settleable Solids	8/22/2016
EXP	160815N002	Normal	WWTP Daily	DA	8/15/2016 Temperature	8/15/2016
EXP	160815N003	Normal	WWTP Daily	DA	8/15/2016 Settleable Solids	8/22/2016
EXP	160815N003	Normal	WWTP Daily	DA	8/15/2016 Temperature	8/15/2016
EXP	160815N004	Normal	Filtrate MOS	DA	8/15/2016 % UVT	8/16/2016
EXP	160815N004	Normal	Filtrate MOS	DA	8/15/2016 Temperature	8/15/2016
EXP	160815N005	Normal	AEROBIC BASIN	DA	8/15/2016 Temperature	8/15/2016
EXP	160815N006	Normal	Primary Effluent grab	DA	8/15/2016 Temperature	8/15/2016
DUE	160815N011	Normal	CC Drinking Water Field Data	PK	8/15/2016 FLOW	11/23/2016
EXP	160816K002	Normal	WWTP Daily	AG	8/16/2016 Settleable Solids	8/23/2016
EXP	160816K002	Normal	WWTP Daily	AG	8/16/2016 Temperature	8/16/2016
EXP	160816K003	Normal	WWTP Daily	AG	8/16/2016 Settleable Solids	8/23/2016
EXP	160816K003	Normal	WWTP Daily	AG	8/16/2016 Temperature	8/16/2016
EXP	160816K004	Normal	Filtrate MOS	AG	8/16/2016 % UVT	8/17/2016
EXP	160816K004	Normal	Filtrate MOS	AG	8/16/2016 Temperature	8/16/2016
EXP	160816K005	Normal	AEROBIC BASIN	AG	8/16/2016 Temperature	8/16/2016
EXP	160816K006	Normal	Primary Effluent grab	AG	8/16/2016 Temperature	8/16/2016
DUE	160816K013	Normal	CC Drinking Water Field Data	PK	8/16/2016 FLOW	11/24/2016
EXP	160816O003	Normal	Contact Tank	JW	8/16/2016 Total Residual Chlorine	8/16/2016
EXP	160816I426	Normal	Wastewater Non-Routine	AG	8/16/2016 Send Out Testing	8/16/2016
EXP	160816I429	Normal	Contact Tank	AG	8/16/2016 Total Residual Chlorine	8/16/2016
EXP	160816I42A	Normal	Contact Tank	AG	8/16/2016 Total Residual Chlorine	8/16/2016
EXP	160817K002	Normal	WWTP Daily	AG	8/17/2016 Settleable Solids	8/24/2016
EXP	160817K002	Normal	WWTP Daily	AG	8/17/2016 Temperature	8/17/2016
EXP	160817K003	Normal	WWTP Daily	AG	8/17/2016 Settleable Solids	8/24/2016
EXP	160817K003	Normal	WWTP Daily	AG	8/17/2016 Temperature	8/17/2016
EXP	160817K004	Normal	Filtrate MOS	AG	8/17/2016 % UVT	8/18/2016
EXP	160817K004	Normal	Filtrate MOS	AG	8/17/2016 Temperature	8/17/2016
EXP	160817K005	Normal	AEROBIC BASIN	AG	8/17/2016 Temperature	8/17/2016
EXP	160817K006	Normal	Primary Effluent grab	AG	8/17/2016 Temperature	8/17/2016
EXP	160817K007	Normal	WWTP Weekly : BOD,TSS	AG	8/17/2016 Send Out Testing	8/17/2016
EXP	160817K008	Normal	WWTP Weekly : BOD,TSS	AG	8/17/2016 Send Out Testing	8/17/2016
Warn	160817K009	Normal	Wastewater Monthly	AG	8/17/2016 Oil and Grease	9/14/2016
	160817K010	Normal	Wastewater Monthly	AG	8/17/2016 Copper	2/13/2017
	160817K010	Normal	Wastewater Monthly	AG	8/17/2016 Zinc	2/13/2017



Sample Tracking

All Incomplete Analyses

CCWQL
01-Sep-16

Warning	SampleID	Status	Project	Who	Collected Analysis	Expires
	EXP 160817K011	Normal	Wastewater % Solids Panel	JW	8/17/2016 Send Out Testing	8/17/2016
	DUE 160817N005	Normal	CC Drinking Water Field Data	EM	8/17/2016 FLOW	11/25/2016
	EXP 1608171307	Normal	Wastewater Non-Routine	JW	8/17/2016 Settleable Solids	8/24/2016
	EXP 1608171520	Normal	Wastewater Non-Routine	JW	8/17/2016 Settleable Solids	8/24/2016
	EXP 160818J002	Normal	WWTP Daily	AG	8/18/2016 Settleable Solids	8/25/2016
	EXP 160818J002	Normal	WWTP Daily	AG	8/18/2016 Temperature	8/18/2016
	EXP 160818J003	Normal	WWTP Daily	AG	8/18/2016 Settleable Solids	8/25/2016
	EXP 160818J003	Normal	WWTP Daily	AG	8/18/2016 Temperature	8/18/2016
	EXP 160818J004	Normal	Filtrate MOS	AG	8/18/2016 % UVT	8/19/2016
Warn	160818J004	Normal	Filtrate MOS	AG	8/18/2016 Alkalinity	9/15/2016
	EXP 160818J004	Normal	Filtrate MOS	AG	8/18/2016 Temperature	8/18/2016
Warn	160818J005	Normal	AEROBIC BASIN	AG	8/18/2016 Alkalinity	9/15/2016
	EXP 160818J005	Normal	AEROBIC BASIN	AG	8/18/2016 Temperature	8/18/2016
Warn	160818J006	Normal	Primary Effluent grab	AG	8/18/2016 Alkalinity	9/15/2016
	EXP 160818J006	Normal	Primary Effluent grab	AG	8/18/2016 Temperature	8/18/2016
	EXP 160818J010	Normal	Rumiano Weekly	AG	8/18/2016 Settleable Solids	8/25/2016
	DUE 160818M005	Normal	CC Drinking Water Field Data	EM	8/18/2016 FLOW	11/26/2016
	EXP 1608181530	Normal	WWTP Weekly : BOD,TSS	JW	8/18/2016 pH	8/18/2016
	EXP 1608181531	Normal	WWTP Weekly : BOD,TSS	JW	8/18/2016 pH	8/18/2016
	EXP 1608181531	Normal	WWTP Weekly : BOD,TSS	JW	8/18/2016 Volatile Suspended Solids	8/25/2016
	EXP 160819J002	Normal	WWTP Daily	AG	8/19/2016 Settleable Solids	8/26/2016
	EXP 160819J002	Normal	WWTP Daily	AG	8/19/2016 Temperature	8/19/2016
	EXP 160819J003	Normal	WWTP Daily	AG	8/19/2016 Settleable Solids	8/26/2016
	EXP 160819J003	Normal	WWTP Daily	AG	8/19/2016 Temperature	8/19/2016
	EXP 160819J004	Normal	Filtrate MOS	AG	8/19/2016 % UVT	8/20/2016
Warn	160819J004	Normal	Filtrate MOS	AG	8/19/2016 Alkalinity	9/16/2016
	EXP 160819J004	Normal	Filtrate MOS	AG	8/19/2016 Temperature	8/19/2016
Warn	160819J005	Normal	AEROBIC BASIN	AG	8/19/2016 Alkalinity	9/16/2016
	EXP 160819J005	Normal	AEROBIC BASIN	AG	8/19/2016 Temperature	8/19/2016
	EXP 160819J005	Normal	AEROBIC BASIN	AG	8/19/2016 Volatile Suspended Solids	8/26/2016
Warn	160819J006	Normal	Primary Effluent grab	AG	8/19/2016 Alkalinity	9/16/2016
	EXP 160819J006	Normal	Primary Effluent grab	AG	8/19/2016 Temperature	8/19/2016
	EXP 160819J006	Normal	Primary Effluent grab	AG	8/19/2016 Volatile Suspended Solids	8/26/2016
	EXP 1608190940	Normal	RAS	AG	8/19/2016 Volatile Suspended Solids	8/26/2016
	DUE 160819N005	Normal	CC Drinking Water Field Data	EM	8/19/2016 FLOW	11/27/2016
	EXP 160820K002	Normal	WWTP Daily	EM	8/20/2016 Settleable Solids	8/27/2016
	EXP 160820K002	Normal	WWTP Daily	EM	8/20/2016 Temperature	8/20/2016
	EXP 160820K003	Normal	WWTP Daily	EM	8/20/2016 Settleable Solids	8/27/2016
	EXP 160820K003	Normal	WWTP Daily	EM	8/20/2016 Temperature	8/20/2016
	EXP 160820K004	Normal	Filtrate MOS	EM	8/20/2016 % UVT	8/21/2016
	EXP 160820K004	Normal	Filtrate MOS	EM	8/20/2016 Temperature	8/20/2016
	EXP 160820K005	Normal	AEROBIC BASIN	EM	8/20/2016 Temperature	8/20/2016
	EXP 160820K006	Normal	Primary Effluent grab	EM	8/20/2016 Temperature	8/20/2016
	DUE 160820P005	Normal	CC Drinking Water Field Data	TW	8/20/2016 FLOW	11/28/2016



Sample Tracking

All Incomplete Analyses

CCWQL
01-Sep-16

Warning	SampleID	Status	Project	Who	Collected Analysis	Expires
EXP	160821O002	Normal	WWTP Daily	DA	8/21/2016 Temperature	8/21/2016
EXP	160821O003	Normal	WWTP Daily	DA	8/21/2016 Temperature	8/21/2016
EXP	160821O004	Normal	Filtrate MOS	DA	8/21/2016 % UVT	8/22/2016
EXP	160821O004	Normal	Filtrate MOS	DA	8/21/2016 Temperature	8/21/2016
EXP	160821O005	Normal	AEROBIC BASIN	DA	8/21/2016 Temperature	8/21/2016
EXP	160821O006	Normal	Primary Effluent grab	DA	8/21/2016 Temperature	8/21/2016
DUE	160821O011	Normal	CC Drinking Water Field Data	RT	8/21/2016 FLOW	11/29/2016
EXP	160822N002	Normal	WWTP Daily	JW	8/22/2016 Temperature	8/22/2016
EXP	160822N003	Normal	WWTP Daily	JW	8/22/2016 Temperature	8/22/2016
EXP	160822N004	Normal	Filtrate MOS	DA	8/22/2016 % UVT	8/23/2016
EXP	160822N004	Normal	Filtrate MOS	DA	8/22/2016 Temperature	8/22/2016
EXP	160822N005	Normal	AEROBIC BASIN	DA	8/22/2016 Temperature	8/22/2016
EXP	160822N006	Normal	Primary Effluent grab	JW	8/22/2016 Temperature	8/22/2016
DUE	160822N011	Normal	CC Drinking Water Field Data	PK	8/22/2016 FLOW	11/30/2016
EXP	160823J002	Normal	WWTP Daily	AG	8/23/2016 Temperature	8/23/2016
EXP	160823J003	Normal	WWTP Daily	AG	8/23/2016 Temperature	8/23/2016
EXP	160823J004	Normal	Filtrate MOS	AG	8/23/2016 % UVT	8/24/2016
EXP	160823J004	Normal	Filtrate MOS	AG	8/23/2016 Temperature	8/23/2016
EXP	160823J005	Normal	AEROBIC BASIN	AG	8/23/2016 Temperature	8/23/2016
EXP	160823J006	Normal	Primary Effluent grab	AG	8/23/2016 Temperature	8/23/2016
DUE	160823N005	Normal	CC Drinking Water Field Data	RT	8/23/2016 FLOW	12/1/2016
EXP	160824J002	Normal	WWTP Daily	AG	8/24/2016 Settleable Solids	8/31/2016
EXP	160824J002	Normal	WWTP Daily	AG	8/24/2016 Temperature	8/24/2016
EXP	160824J003	Normal	WWTP Daily	AG	8/24/2016 Settleable Solids	8/31/2016
EXP	160824J003	Normal	WWTP Daily	AG	8/24/2016 Temperature	8/24/2016
EXP	160824J004	Normal	Filtrate MOS	AG	8/24/2016 % UVT	8/25/2016
EXP	160824J004	Normal	Filtrate MOS	AG	8/24/2016 Temperature	8/24/2016
EXP	160824J005	Normal	AEROBIC BASIN	AG	8/24/2016 Temperature	8/24/2016
EXP	160824J006	Normal	Primary Effluent grab	AG	8/24/2016 Temperature	8/24/2016
DUE	160824M005	Normal	CC Drinking Water Field Data	EM	8/24/2016 FLOW	12/2/2016
EXP	160825J002	Normal	WWTP Daily	AG	8/25/2016 Temperature	8/25/2016
EXP	160825J003	Normal	WWTP Daily	AG	8/25/2016 Temperature	8/25/2016
EXP	160825J004	Normal	Filtrate MOS	AG	8/25/2016 % UVT	8/26/2016
EXP	160825J004	Normal	Filtrate MOS	AG	8/25/2016 Temperature	8/25/2016
EXP	160825J005	Normal	AEROBIC BASIN	AG	8/25/2016 Temperature	8/25/2016
EXP	160825J006	Normal	Primary Effluent grab	AG	8/25/2016 Temperature	8/25/2016
EXP	160825L002	Normal	Digester 2: VA / ALK	AG	8/25/2016 Volatile Reduction	8/26/2016
EXP	160825L003	Normal	Digester 1: VA /ALK	AG	8/25/2016 Volatile Reduction	8/26/2016
DUE	160825L008	Normal	CC Drinking Water Field Data	EM	8/25/2016 FLOW	12/3/2016
EXP	160826K002	Normal	WWTP Daily	AG	8/26/2016 Temperature	8/26/2016
EXP	160826K003	Normal	WWTP Daily	AG	8/26/2016 Temperature	8/26/2016
EXP	160826K004	Normal	Filtrate MOS	AG	8/26/2016 % UVT	8/27/2016
EXP	160826K004	Normal	Filtrate MOS	AG	8/26/2016 Temperature	8/26/2016
EXP	160826K005	Normal	AEROBIC BASIN	AG	8/26/2016 Temperature	8/26/2016



Sample Tracking

All Incomplete Analyses

CCWQL
01-Sep-16

Warning	SampleID	Status	Project	Who	Collected Analysis	Expires
EXP	160826K006	Normal	Primary Effluent grab	AG	8/26/2016 Temperature	8/26/2016
DUE	160826L007	Normal	CC Drinking Water Field Data	EM	8/26/2016 FLOW	12/4/2016
	160827K002	Normal	WWTP Daily	EM	8/27/2016 Settleable Solids	9/3/2016
EXP	160827K002	Normal	WWTP Daily	EM	8/27/2016 Temperature	8/27/2016
	160827K003	Normal	WWTP Daily	EM	8/27/2016 Settleable Solids	9/3/2016
EXP	160827K003	Normal	WWTP Daily	EM	8/27/2016 Temperature	8/27/2016
EXP	160827K004	Normal	Filtrate MOS	EM	8/27/2016 % UVT	8/28/2016
EXP	160827K004	Normal	Filtrate MOS	EM	8/27/2016 Temperature	8/27/2016
EXP	160827K005	Normal	AEROBIC BASIN	EM	8/27/2016 Temperature	8/27/2016
EXP	160827K006	Normal	Primary Effluent grab	EM	8/27/2016 Temperature	8/27/2016
EXP	160827K008	Normal	CC Drinking Water Daily	EM	8/27/2016 Rainfall	8/27/2016
EXP	160827K008	Normal	CC Drinking Water Daily	EM	8/27/2016 Smith River Level	8/27/2016
EXP	160827K008	Normal	CC Drinking Water Daily	EM	8/27/2016 Temperature	8/27/2016
EXP	160827K009	Normal	CC Drinking Water Daily	EM	8/27/2016 Temperature	8/27/2016
DUE	160827K010	Normal	CC Drinking Water Field Data	EM	8/27/2016 Chlorine Probe	12/5/2016
DUE	160827K011	Normal	CC Drinking Water Field Data	EM	8/27/2016 Chlorine Feed	12/5/2016
DUE	160827K011	Normal	CC Drinking Water Field Data	EM	8/27/2016 Chlorine Probe	12/5/2016
DUE	160827K011	Normal	CC Drinking Water Field Data	EM	8/27/2016 FLOW	12/5/2016
EXP	160828O002	Normal	WWTP Daily	DA	8/28/2016 Temperature	8/28/2016
EXP	160828O003	Normal	WWTP Daily	DA	8/28/2016 Temperature	8/28/2016
EXP	160828O004	Normal	Filtrate MOS	DA	8/28/2016 % UVT	8/29/2016
EXP	160828O004	Normal	Filtrate MOS	DA	8/28/2016 Temperature	8/28/2016
EXP	160828O005	Normal	AEROBIC BASIN	DA	8/28/2016 Temperature	8/28/2016
EXP	160828O006	Normal	Primary Effluent grab	DA	8/28/2016 Temperature	8/28/2016
DUE	160828O011	Normal	CC Drinking Water Field Data	RT	8/28/2016 FLOW	12/6/2016
EXP	160829J002	Normal	WWTP Daily	DA	8/29/2016 Temperature	8/29/2016
EXP	160829J003	Normal	WWTP Daily	DA	8/29/2016 Temperature	8/29/2016
EXP	160829J004	Normal	Filtrate MOS	DA	8/29/2016 % UVT	8/30/2016
EXP	160829J004	Normal	Filtrate MOS	DA	8/29/2016 Temperature	8/29/2016
EXP	160829J005	Normal	AEROBIC BASIN	DA	8/29/2016 Temperature	8/29/2016
EXP	160829J006	Normal	Primary Effluent grab	DA	8/29/2016 Temperature	8/29/2016
EXP	160829K001	Normal	Wastewater Microbiology	JW	8/29/2016 Fecal Coliform: MPN	8/30/2016
DUE	160829M005	Normal	CC Drinking Water Field Data	WF	8/29/2016 FLOW	12/7/2016
EXP	160829145A	Normal	WWTP Weekly : BOD,TSS	JW	8/29/2016 BOD	8/31/2016
EXP	160829145B	Normal	WWTP Weekly : BOD,TSS	JW	8/29/2016 BOD	8/31/2016
Warn	160829145B	Normal	WWTP Weekly : BOD,TSS	JW	8/29/2016 Volatile Suspended Solids	9/5/2016
	160830P002	Normal	WWTP Daily	EM	8/30/2016 Settleable Solids	9/6/2016
EXP	160830P002	Normal	WWTP Daily	EM	8/30/2016 Temperature	8/30/2016
	160830P003	Normal	WWTP Daily	EM	8/30/2016 Settleable Solids	9/6/2016
EXP	160830P003	Normal	WWTP Daily	EM	8/30/2016 Temperature	8/30/2016
EXP	160830P004	Normal	Filtrate MOS	EM	8/30/2016 % UVT	8/31/2016
EXP	160830P004	Normal	Filtrate MOS	EM	8/30/2016 Temperature	8/30/2016
EXP	160830P005	Normal	AEROBIC BASIN	AG	8/30/2016 Temperature	8/30/2016
DUE	160830P006	Normal	Primary Effluent grab	EM	8/30/2016 BOD	9/1/2016



Sample Tracking

All Incomplete Analyses

CCWQL
01-Sep-16

Warning	SampleID	Status	Project	Who	Collected Analysis	Expires
EXP	160830P006	Normal	Primary Effluent grab	EM	8/30/2016 Temperature	8/30/2016
DUE	160830P007	Normal	WWTP Weekly : BOD,TSS	EM	8/30/2016 BOD	9/1/2016
DUE	160830P008	Normal	WWTP Weekly : BOD,TSS	EM	8/30/2016 BOD	9/1/2016
DUE	160830P013	Normal	CC Drinking Water Field Data	WF	8/30/2016 FLOW	12/8/2016
	1608301513	Normal	Wastewater Non-Routine	JW	8/30/2016 Settleable Solids	9/6/2016
	160830151A	Normal	Wastewater Non-Routine	AG	8/30/2016 Settleable Solids	9/6/2016
EXP	160830P015	Normal	NPDES Weekly Micro	EM	8/30/2016 Enterococci	8/30/2016
EXP	160830P015	Normal	NPDES Weekly Micro	EM	8/30/2016 Fecal Coliform: MPN	8/31/2016
EXP	160830P015	Normal	NPDES Weekly Micro	EM	8/30/2016 Total Coliform: MPN	8/30/2016
EXP	160830P016	Normal	Wastewater Microbiology	EM	8/30/2016 Enterococci	8/30/2016
EXP	160830P016	Normal	Wastewater Microbiology	EM	8/30/2016 Fecal Coliform: MPN	8/31/2016
EXP	160830151B	Normal	Client Enterococcus	WO	8/30/2016 Enterococci	8/30/2016
EXP	1608301516	Normal	Client Enterococcus	WO	8/30/2016 Enterococci	8/30/2016
EXP	160830151C	Normal	Client Enterococcus	WO	8/30/2016 Enterococci	8/30/2016
EXP	1608301519	Normal	Wastewater Non-Routine	EM	8/30/2016 Send Out Testing	8/30/2016
	160831J002	Normal	WWTP Daily	EM	8/31/2016 Settleable Solids	9/7/2016
EXP	160831J002	Normal	WWTP Daily	EM	8/31/2016 Temperature	8/31/2016
	160831J003	Normal	WWTP Daily	JW	8/31/2016 Settleable Solids	9/7/2016
EXP	160831J003	Normal	WWTP Daily	JW	8/31/2016 Temperature	8/31/2016
DUE	160831J004	Normal	Filtrate MOS	EM	8/31/2016 % UVT	9/1/2016
EXP	160831J004	Normal	Filtrate MOS	EM	8/31/2016 Temperature	8/31/2016
EXP	160831J005	Normal	AEROBIC BASIN	AG	8/31/2016 Temperature	8/31/2016
	160831J005	Normal	AEROBIC BASIN	AG	8/31/2016 Volatile Suspended Solids	9/7/2016
EXP	160831J006	Normal	Primary Effluent grab	EM	8/31/2016 Temperature	8/31/2016
	160831J006	Normal	Primary Effluent grab	EM	8/31/2016 Volatile Suspended Solids	9/7/2016
Warn	160831J007	Normal	WWTP Weekly : BOD,TSS	EM	8/31/2016 BOD	9/2/2016
Warn	160831J008	Normal	WWTP Weekly : BOD,TSS	JW	8/31/2016 BOD	9/2/2016
Warn	1608311000	Normal	Wastewater Non-Routine	JW	8/31/2016 BOD	9/2/2016
Warn	160831K002	Normal	Rumiano Weekly	AG	8/31/2016 BOD	9/2/2016
	160831K002	Normal	Rumiano Weekly	AG	8/31/2016 Settleable Solids	9/7/2016
DUE	160831K007	Normal	CC Drinking Water Field Data	WF	8/31/2016 FLOW	12/9/2016
DUE	1608311059	Normal	Client 9223: P/A	WO	8/31/2016 Escherichia coli: P/A	9/1/2016
DUE	1608311059	Normal	Client 9223: P/A	WO	8/31/2016 Total Coliform: P/A	9/1/2016
DUE	1608311100	Normal	Client 9223: P/A	WO	8/31/2016 Escherichia coli: P/A	9/1/2016
DUE	1608311100	Normal	Client 9223: P/A	WO	8/31/2016 Total Coliform: P/A	9/1/2016
DUE	160831110A	Normal	Client 9223: P/A	WO	8/31/2016 Escherichia coli: P/A	9/1/2016
DUE	160831110A	Normal	Client 9223: P/A	WO	8/31/2016 Total Coliform: P/A	9/1/2016
DUE	1608311524	Normal	CC Drinking Water : PA	WF	8/31/2016 Escherichia coli: P/A	9/1/2016
EXP	1608311524	Normal	CC Drinking Water : PA	WF	8/31/2016 Free Chlorine	8/31/2016
DUE	1608311524	Normal	CC Drinking Water : PA	WF	8/31/2016 Total Coliform: P/A	9/1/2016
DUE	160831P001	Normal	Wastewater Microbiology	AG	8/31/2016 Fecal Coliform: MPN	9/1/2016
EXP	160831P002	Normal	Contact Tank	AG	8/31/2016 Total Residual Chlorine	8/31/2016

Sandi Byrne
 Crescent City Water Quality Control Laboratory
 377 J Street
 Crescent City, CA 95531

September 14, 2016

Sandi:

I have enclosed our report "NPDES Compliance Chronic Toxicity Testing of City of Crescent City Wastewater Treatment Plant Effluent" for the effluent sample collected August 30, 2016. The results of this test are summarized below.

Chronic Effects of Crescent City Effluent on Giant Kelp (*Macrocystis pyrifera*)

There were *no* significant reductions in kelp germination or growth; the germination and growth NOEC were 13.2% effluent, resulting in 7.6 TUc for both test endpoints.

Kelp Test Endpoint =	Germination	Growth
NOEC =	13.2% effluent	13.2% effluent
TUc (100/NOEC) =	7.6 TUc	7.6 TUc
Germination EC25 or Growth IC25 =	>13.2% effluent	>13.2% effluent
TUc (100/EC25 or 100/IC25) =	<7.6 TUc	<7.6 TUc

TSD (NOEC) vs. EC25-IC25 vs. TST

The test data were also analyzed using the Test of Significant Toxicity (TST) statistical method to compare the results of the proposed method to the current approach of calculating TUc as 100/NOEC, as well as 100/EC25 and 100/IC25. As indicated below, these alternative statistical methods do not support the determination of toxicity

TSD (NOEC) Method		EC25/IC25 Method		TST Method	
Germination	Growth	Germination	Growth	Germination	Growth
non-toxic	non-toxic	non-toxic	non-toxic	non-toxic	non-toxic

Note - The TST method does not use TUc to determine compliance with a numeric limit, but rather is based simply on a "non-toxic/toxic" basis. The above comparative table has been prepared accordingly, with the TUc calculated from EC25 and IC25 point estimates or the NOEC being characterized as "non-toxic/toxic".

If you have any questions regarding this testing, please feel free to call my colleague Dr. Brant Jorgenson or myself at (707) 207-7760.

Regards,

Mike McElroy

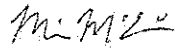

2016.09.14

10:25:54 -08'00'

Michael McElroy
Senior Aquatic Ecotoxicologist



Pacific EcoRisk is accredited in accordance with NELAP (ORELAP ID 4043). Pacific EcoRisk certifies that the test results reported herein conform to the most current NELAP requirements for parameters for which accreditation is required and available. Any exceptions to NELAP requirements are noted, where applicable, in the body of the report. This report shall not be reproduced, except in full, without the written consent of Pacific EcoRisk. This testing was performed under Lab Order 26221.

NPDES Compliance Chronic Toxicity Testing of City of Crescent City Wastewater Treatment Plant Effluent

Sample collected August 30, 2016

Performed For

Crescent City
Water Quality Control Laboratory
377 J Street
Crescent City, CA 95531

Prepared By

Pacific EcoRisk
2250 Cordelia Road
Fairfield, CA 94534

September 2016



PACIFIC ECORISK
ENVIRONMENTAL CONSULTING & TESTING

NPDES Compliance Chronic Toxicity Testing of City of Crescent City Wastewater Treatment Plant Effluent

Sample collected August 30, 2016

Table of Contents

	Page
1. INTRODUCTION	1
2. TOXICITY TEST PROCEDURES	1
2.1 Receipt and Handling of the Effluent Sample	1
2.2 Algal Germination and Growth Toxicity Testing with <i>Macrocystis pyrifera</i>	1
2.2.1 Reference Toxicant Testing of the <i>Macrocystis pyrifera</i>	2
3. TESTING RESULTS	3
3.1 Effects of Crescent City Effluent on <i>Macrocystis pyrifera</i>	3
3.2 Reference Toxicant Toxicity to <i>Macrocystis pyrifera</i>	4
4. SUMMARY AND CONCLUSIONS	5
4.1 QA/QC Summary	5

Appendices

- Appendix A Chain-of-Custody Record for the Collection and Delivery of the Crescent City Effluent Sample
- Appendix B Test Data and Summary of Statistics for the Evaluation of the Chronic Toxicity of Crescent City Effluent to the Giant Kelp *Macrocystis pyrifera*
- Appendix C Test Data and Summary of Statistics for the Reference Toxicant Evaluation of the Giant Kelp *Macrocystis pyrifera*

1. INTRODUCTION

Crescent City has contracted Pacific EcoRisk (PER) to perform an evaluation of the chronic toxicity of Crescent City Wastewater Treatment Plant (Crescent City) effluent. This toxicity evaluation consisted of performing the US EPA's short-term chronic toxicity test with giant kelp (*Macrocystis pyrifera*) utilizing an effluent sample collected August 30, 2016. In order to assess the sensitivity of the test organisms to toxic stress, a concurrent reference toxicant test was also performed. This report describes the performance and results of this testing.

2. TOXICITY TEST PROCEDURES

The methods used in this testing followed the guidelines established by the EPA manual "Short-Term Methods for Measuring the Chronic Toxicity of Effluents and Receiving Waters to West Coast Marine and Estuarine Organisms" (EPA/600/R-95/136).

2.1 Receipt and Handling of the Effluent Sample

On August 30, a sample of Crescent City effluent was collected into an appropriately cleaned sample container and shipped via overnight delivery, on ice and under chain-of-custody, to the PER laboratory in Fairfield, CA. Upon receipt at the laboratory, aliquots of the sample were collected for analysis of initial water quality characteristics (Table 1), with the remainder of the sample being stored at $\leq 6^{\circ}\text{C}$, except when being used to prepare test solutions. The chain-of-custody record for the collection and delivery of this sample is presented in Appendix A.

Table 1. Initial water quality characteristics of Crescent City effluent samples.

Sample Received	Sample ID	Temp ($^{\circ}\text{C}$)	pH	D.O (mg/L)	Salinity (ppt)	Conductivity ($\mu\text{S/cm}$)	Total Ammonia (mg/L N)
8/31/16	Effluent G	1.7	7.67	6.7	0.4	642	11.9

2.2 Algal Germination and Growth Toxicity Testing with *Macrocystis pyrifera*

This chronic toxicity test with *M. pyrifera* consists of exposing kelp zoospores to the effluent for approximately 48 hours, after which the effects on zoospore germination and subsequent gametophyte growth (measured as gametophyte tube length) are determined. The specific procedures used in this test are described below.

The Lab Water Control medium for this test consisted of filtered ($1\text{-}\mu\text{m}$) natural seawater (obtained from the U.C. Granite Canyon Marine Laboratory Carmel, CA). The effluent was adjusted to the test salinity of 34 ppt via addition of hypersaline brine (HSB). The Lab Water Control medium and salinity-adjusted effluent were then used to prepare test solutions at test

treatment concentrations of 0.8%, 1.6%, 3.3%, 6.6%, and 13.2% effluent. As an additional QA measure and in order to assess potential effects of the HSB addition on the effluent, a "Brine Control" was also prepared consisting of filtered seawater diluted to the salinity of the effluent sample using Type 1 lab water, and then adjusted back up to the test salinity of 34 ppt via addition of the HSB. Routine water quality characteristics (pH, D.O., and salinity) were measured for each test solution prior to use in this test.

Zoospores were obtained from kelp fronds (blades) of *M. pyrifera* collected from wild populations (K. Siewers, Santa Cruz, CA). Approximately 25 fronds were cleaned of debris and epiphytic organisms by gently rubbing the blades while rinsing with 1- μ m filtered seawater, after which the blades were further desiccated by being exposed to air for approximately one hour. The desiccated kelp fronds were then rinsed with filtered seawater and placed into a 1-L glass beaker containing 1- μ m filtered seawater at 15°C in order to induce release of zoospores. After allowing zoospore release for approximately one hour, the kelp fronds were removed from the beakers, and the remaining solution was allowed to settle for 30 minutes, after which approximately 25% of the overlying water was decanted from the top of the solution into a separate clean beaker. Zoospore density was determined using a hemacytometer.

There were five replicates at each test treatment, each replicate consisting of a 450-mL polyethylene dish containing 200 mL of test solution. A glass microscope slide was placed into each replicate to provide a zoospore settling and germination substrate, after which the test was initiated by the addition of zoospores into each replicate to a final density of approximately 7,500 spores/mL. These replicate containers were randomly positioned within a temperature-controlled room at 15°C, under cool-white fluorescent lighting on a 16L:8D photoperiod.

After 48 (\pm 2) hours exposure, the contents of each test container were fixed via addition of glutaraldehyde. Each replicate slide was subsequently examined microscopically to determine the percent successful germination of the settled zoospores and the growth of the resulting gametophytes, as measured by germ tube length. The resulting germination and germ tube length data were analyzed to determine any impairment resulting from exposure to the effluent. All statistical analyses were performed using the CETIS[®] statistical software (TidePool Scientific, McKinleyville, CA).

2.2.1 Reference Toxicant Testing of the *Macrocystis pyrifera*

In order to assess the sensitivity of the test organisms to toxic stress, a reference toxicant test was performed. This reference toxicant test was performed similarly to the effluent toxicity test, except that test solutions consisted of Lab Water Control medium (filtered seawater) spiked with KCl at concentrations of 2, 4, 8, 16, 24, and 32 g/L. The resulting test response data were analyzed to determine key dose-response point estimates. All statistical analyses were made using the CETIS software. These response endpoints were then compared to the typical response ranges established by the mean \pm 2 SD of the point estimates generated by the most recent previous reference toxicant tests performed by this lab.

3. TESTING RESULTS

3.1 Effects of Crescent City Effluent on *Macrocystis pyrifera*

The results of this test are summarized in Table 2. There were no significant reductions in kelp germination or growth; the germination and growth NOEC were 13.2% effluent, resulting in 7.6 TUc for both test endpoints. Test data and summary of statistical analyses are presented in Appendix B.

Table 2. Effects of Crescent City effluent on <i>Macrocystis pyrifera</i> germination and growth.		
Effluent Treatment	Mean % Germination ^a	Mean Germ Tube Length (μm) ^a
Lab Water Control	91.6	16.7
Brine Control	86.2	14.8
0.8%	90.8	16.5
1.6%	87.2	15.8
3.3%	87.6	15.4
6.6%	85.8	14.3
13.2%	87.0	14.0
Summary of Key Statistics		
NOEC =	13.2% effluent	13.2% effluent
TUc (100/NOEC) =	7.6	7.6
Germination EC ₂₅ or Growth IC ₂₅ =	>13.2% effluent ^b	>13.2% effluent
TUc (100/EC ₂₅ or 100/IC ₂₅) =	<7.6	<7.6

a - The germination and growth response in the Brine Control treatment were significantly less than in the Lab Water Control, indicating that the use of brine may have impaired the germination and growth of *M. pyrifera*. Accordingly, the test data were analyzed comparing the effluent treatments to the Brine Control.

b - Due to the absence of any reductions in germination, the EC point estimates could not be calculated, but can be determined by inspection to be >13.2% effluent.

3.2 Reference Toxicant Toxicity to *Macrocystis pyrifera*

The results of this test are summarized in Table 3. The germination EC₅₀ and growth IC₅₀ for this test were consistent with the typical response ranges established by reference toxicant test database for this species, indicating that the test organisms were responding to toxic stress in a typical fashion. The test data and summary of statistical analyses for this test are presented in Appendix C.

Table 3. Reference toxicity testing: effects of KCl on <i>Macrocystis pyrifera</i> .		
KCl Concentration (gm/L)	Mean % Germination	Mean Germ Tube Length (μ m)
Lab Water Control	83.8	16.0
2	85.8	14.9*
4	85.8	15.1*
8	15.8*	12.8*
12	13.4*	11.1*
16	2.2*	9.5*
32	0*	-
Summary of Statistics		
Germination EC ₅₀ or Growth IC ₅₀ =	6.72 g/L KCl	18.5 g/L KCl

* The response at this test treatment was significantly less than the Lab Water Control treatment response ($p < 0.05$).

4. SUMMARY AND CONCLUSIONS

An evaluation of the chronic toxicity of Crescent City effluent was performed using an effluent sample collected August 30, 2016. The results of this test are summarized below.

Chronic Effects of Crescent City Effluent on Giant Kelp (*Macrocystis pyrifera*)

There were no significant reductions in kelp germination or growth; the germination and growth NOEC were 13.2% effluent, resulting in 7.6 TUC for both test endpoints.

4.1 QA/QC Summary

Test Conditions – Test conditions (pH, D.O., temperature, etc.) were within acceptable limits. All analyses were performed according to laboratory Standard Operating Procedures.

Negative Control – The biological responses at the Control treatments were within acceptable limits.

Positive Control – The results of the reference toxicant test were consistent with the typical response ranges established by the reference toxicant test database for this species, indicating that these test organisms were responding to toxicant stress in a typical and consistent fashion.

Concentration Response Relationships – The concentration-response relationships for these tests were evaluated as per EPA guidelines (EPA-821-B-00-004) and were determined to be acceptable.

Appendix A

Chain-of-Custody Record for the Collection and Delivery of the Crescent City Effluent Sample

CHAIN-OF-CUSTODY RECORD

Pacific EcoRisk
 2250 Cordelia Rd., Fairfield, CA 94534
 (707) 207-7760 FAX (707) 207-7916

Results To:		City of Crescent City		Invoice To:		City of Crescent City		REQUESTED ANALYSIS									
Address:		377 J Street Crescent City, CA 95531		Address:		377 J Street Crescent City, CA 95531											
Phone:		707-465-5258		Phone:		707-465-5258											
Attn:		Sandi Byrne		Attn:		Sandi Byrne											
E-mail:		sbyrne@crescentcity.org		E-mail:		sbyrne@crescentcity.org											
Project Name:																	
P.O.#/Ref:		4986															
Client Sample ID	Sample Date	Sample Time	Sample Matrix*	Grab/Comp	Number	Container Type											
1	#####		EFF	Grab	1	19 gal bottle											
2	8/30/16	12:36	EFF	Grab	1	19 gal bottle	Grant keep (Microcystis lyngbya) germination and growth (EPA/600/R-95/136) X										
3																	
4																	
5																	
6																	
7																	
8																	
9																	
10																	

Samples collected by: <u>Liz Martinez</u>	RECEIVED BY:
Comments/Special Instruction: 1 in extra sample bottle 1/2 ✓	Signature: <u>[Signature]</u> Print: <u>Elizabeth Martinez</u> Organization: <u>CCWRTP</u> Date: <u>8/30/16</u> Time: <u>12:41</u>
	RECEIVED BY: Signature: <u>[Signature]</u> Print: <u>[Signature]</u> Organization: <u>[Organization]</u> Date: <u>8/30/16</u> Time: <u>12:46</u>
	RECEIVED BY: Signature: <u>[Signature]</u> Print: <u>[Signature]</u> Organization: <u>[Organization]</u> Date: <u>8/30/16</u> Time: <u>10:25</u>

Appendix B

Test Data and Summary of Statistics for the Evaluation of the Chronic Toxicity of Crescent City Effluent to the Giant Kelp *Macrocystis pyrifera*

CETIS Summary Report

Report Date: 13 Sep-16 16:54 (p 1 of 2)
 Test Code: 69596 | 15-1906-8524

Macrocystis Germination and Growth Test Pacific EcoRisk

Batch ID: 12-3489-8729	Test Type: Growth-Germination	Analyst: Simin Delijani
Start Date: 31 Aug-16 15:50	Protocol: EPA/600/R-95/136 (1995)	Diluent: Filtered Seawater
Ending Date: 02 Sep-16 15:40	Species: Macrocystis pyrifera	Brine: Hyper-Saline Brine
Duration: 48h	Source: Dave Gutoff	Age: N/A

Sample ID: 04-3621-6011	Code: Effluent	Client: Crescent City
Sample Date: 30 Aug-16 12:36	Material: Effluent	Project: 26221
Receive Date: 31 Aug-16 10:55	Source: Crescent City Harbor	
Sample Age: 27h (1.7 °C)	Station: Effluent-G	

Comparison Summary

Analysis ID	Endpoint	NOEL	LOEL	TOEL	PMSD	TU	Method
09-2032-8949	Germination Rate	<0	0		3.13%		Equal Variance t Two-Sample Test
18-0677-7428	Germination Rate	3.3	>3.3	NA	3.78%	30.3	TST-Weich's t Test
03-3467-4587	Germination Rate	13.2	>13.2	NA	10.1%	7.576	Dunnett Multiple Comparison Test
06-8014-1444	Mean Length	<0	0		3.48%		Equal Variance t Two-Sample Test
09-8435-5283	Mean Length	3.3	>3.3	NA	2.77%	30.3	TST-Weich's t Test
02-9839-1281	Mean Length	13.2	>13.2	NA	6.41%	7.576	Dunnett Multiple Comparison Test

Point Estimate Summary

Analysis ID	Endpoint	Level	%	95% LCL	95% UCL	TU	Method
02-4914-4477	Mean Length	IC5	4.82	3.29	8.58	20.77	Linear Interpolation (ICPIN)
		IC10	10.5	3.67	N/A	9.564	
		IC15	>13.2	N/A	N/A	<7.576	
		IC20	>13.2	N/A	N/A	<7.576	
		IC25	>13.2	N/A	N/A	<7.576	
		IC40	>13.2	N/A	N/A	<7.576	
		IC50	>13.2	N/A	N/A	<7.576	

Germination Rate Summary

C-%	Control Type	Count	Mean	95% LCL	95% UCL	Min	Max	Std Err	Std Dev	CV%	%Effect
0	Lab Water Contr	5	0.916	0.902	0.93	0.9	0.93	0.0051	0.0114	1.24%	0.0%
0	Brine Control	5	0.862	0.814	0.91	0.8	0.9	0.0174	0.039	4.52%	5.9%
0.8		5	0.908	0.838	0.978	0.82	0.96	0.0252	0.0563	6.2%	0.87%
1.6		5	0.872	0.821	0.923	0.81	0.91	0.0185	0.0415	4.76%	4.8%
3.3		5	0.876	0.845	0.907	0.84	0.91	0.0112	0.0251	2.87%	4.37%
6.6		5	0.858	0.729	0.987	0.68	0.93	0.0464	0.104	12.1%	6.33%
13.2		5	0.87	0.855	0.885	0.85	0.88	0.00548	0.0122	1.41%	5.02%

Mean Length Summary

C-%	Control Type	Count	Mean	95% LCL	95% UCL	Min	Max	Std Err	Std Dev	CV%	%Effect
0	Lab Water Contr	5	16.7	16.1	17.2	16	17	0.189	0.422	2.53%	0.0%
0	Brine Control	5	14.8	14.1	15.5	14	15.3	0.248	0.554	3.75%	11.3%
0.8		5	16.5	15.6	17.3	15.8	17.5	0.294	0.658	4.0%	1.2%
1.6		5	15.8	14.9	16.7	15.3	17	0.322	0.719	4.55%	5.04%
3.3		5	15.4	15.2	15.5	15.3	15.5	0.049	0.11	0.71%	7.68%
6.6		5	14.3	13.5	15.2	13.8	15.3	0.303	0.677	4.72%	13.9%
13.2		5	14	12.9	15	13	15	0.37	0.826	5.92%	16.2%

CETIS Summary Report

Report Date: 13 Sep-16 16:54 (p 2 of 2)
 Test Code: 69596 | 15-1906-8524

Macrocystis Germination and Growth Test							Pacific EcoRisk
Germination Rate Detail							
C-%	Control Type	Rep 1	Rep 2	Rep 3	Rep 4	Rep 5	
0	Lab Water Contr	0.92	0.9	0.92	0.93	0.91	
0	Brine Control	0.88	0.8	0.85	0.88	0.9	
0.8		0.96	0.92	0.82	0.89	0.95	
1.6		0.81	0.89	0.91	0.9	0.85	
3.3		0.91	0.87	0.88	0.84	0.86	
6.6		0.89	0.93	0.68	0.86	0.93	
13.2		0.88	0.85	0.88	0.87	0.87	
Mean Length Detail							
C-%	Control Type	Rep 1	Rep 2	Rep 3	Rep 4	Rep 5	
0	Lab Water Contr	17	16.5	16.8	17	16	
0	Brine Control	15.3	14	15.3	14.8	14.5	
0.8		17.5	16.5	16.5	16	15.8	
1.6		17	15.5	16	15.3	15.3	
3.3		15.3	15.5	15.5	15.3	15.3	
6.6		15.3	13.8	14.8	14	13.8	
13.2		13.3	14.5	13	14	15	
Germination Rate Binomials							
C-%	Control Type	Rep 1	Rep 2	Rep 3	Rep 4	Rep 5	
0	Lab Water Contr	92/100	90/100	92/100	93/100	91/100	
0	Brine Control	88/100	80/100	85/100	88/100	90/100	
0.8		96/100	92/100	82/100	89/100	95/100	
1.6		81/100	89/100	91/100	90/100	85/100	
3.3		91/100	87/100	88/100	84/100	88/100	
6.6		89/100	93/100	68/100	86/100	93/100	
13.2		88/100	85/100	88/100	87/100	87/100	

CETIS Analytical Report

Report Date: 06 Sep-16 15:20 (p 1 of 3)
 Test Code: 69596 | 15-1905-8524

Macrocyctis Germination and Growth Test Pacific EcoRisk

Analysis ID: 03-3467-4587 Endpoint: Germination Rate CETIS Version: CETISv1.8.7
 Analyzed: 06 Sep-16 16:17 Analysis: Parametric-Control vs Treatments Official Results: Yes

Data Transform	Zeta	Alt Hyp	Trials	Seed	PMSD	NOEL	LOEL	TOEL	TU
Angular (Corrected)	NA	C > T	NA	NA	10.1%	13.2	>13.2	NA	7.576

Dunnett Multiple Comparison Test

Control	vs C-%	Test Stat	Critical	MSD	DF	P-Value	P-Type	Decision(α:5%)
Brine Control	0.8	-1.63	2.36	0.116	8	0.9975	CDF	Non-Significant Effect
	1.6	-0.314	2.36	0.116	8	0.9096	CDF	Non-Significant Effect
	3.3	-0.398	2.36	0.116	8	0.9246	CDF	Non-Significant Effect
	6.6	-0.131	2.36	0.116	8	0.8691	CDF	Non-Significant Effect
	13.2	-0.194	2.36	0.116	8	0.8842	CDF	Non-Significant Effect

ANOVA Table

Source	Sum Squares	Mean Square	DF	F Stat	P-Value	Decision(α:5%)
Between	0.02155385	0.00431077	5	0.711	0.6208	Non-Significant Effect
Error	0.14543	0.006059583	24			
Total	0.1669838		29			

Distributional Tests

Attribute	Test	Test Stat	Critical	P-Value	Decision(α:1%)
Variances	Bartlett Equality of Variance	14.7	15.1	0.0119	Equal Variances
Distribution	Shapiro-Wilk W Normality	0.912	0.903	0.0171	Normal Distribution

Germination Rate Summary

C-%	Control Type	Count	Mean	95% LCL	95% UCL	Median	Min	Max	Std Err	CV%	%Effect
0	Brine Control	5	0.862	0.814	0.91	0.88	0.8	0.9	0.0174	4.52%	0.0%
0.8		5	0.908	0.838	0.978	0.92	0.82	0.96	0.0252	6.2%	-5.34%
1.6		5	0.872	0.821	0.923	0.89	0.81	0.91	0.0185	4.76%	-1.16%
3.3		5	0.876	0.845	0.907	0.88	0.84	0.91	0.0112	2.87%	-1.62%
6.6		5	0.858	0.729	0.987	0.89	0.68	0.93	0.0464	12.1%	0.46%
13.2		5	0.87	0.855	0.885	0.87	0.85	0.88	0.00548	1.41%	-0.93%

Angular (Corrected) Transformed Summary

C-%	Control Type	Count	Mean	95% LCL	95% UCL	Median	Min	Max	Std Err	CV%	%Effect
0	Brine Control	5	1.19	1.12	1.26	1.22	1.11	1.25	0.0246	4.6%	0.0%
0.8		5	1.27	1.16	1.39	1.28	1.13	1.37	0.0424	7.45%	-6.72%
1.6		5	1.21	1.13	1.28	1.23	1.12	1.27	0.0271	5.01%	-1.3%
3.3		5	1.21	1.16	1.26	1.22	1.16	1.27	0.0171	3.16%	-1.64%
6.6		5	1.2	1.03	1.37	1.23	0.97	1.3	0.0615	11.5%	-0.54%
13.2		5	1.2	1.18	1.22	1.2	1.17	1.22	0.00803	1.49%	-0.8%

CETIS Analytical Report

Report Date: 06 Sep-16 15:20 (p 2 of 3)
Test Code: 69596 | 15-1906-8524

Macrocyctis Germination and Growth Test Pacific EcoRisk

Analysis ID: 03-3467-4587 Endpoint: Germination Rate CETIS Version: CETISv1.8.7
Analyzed: 06 Sep-16 15:17 Analysis: Parametric-Control vs Treatments Official Results: Yes

Graphics

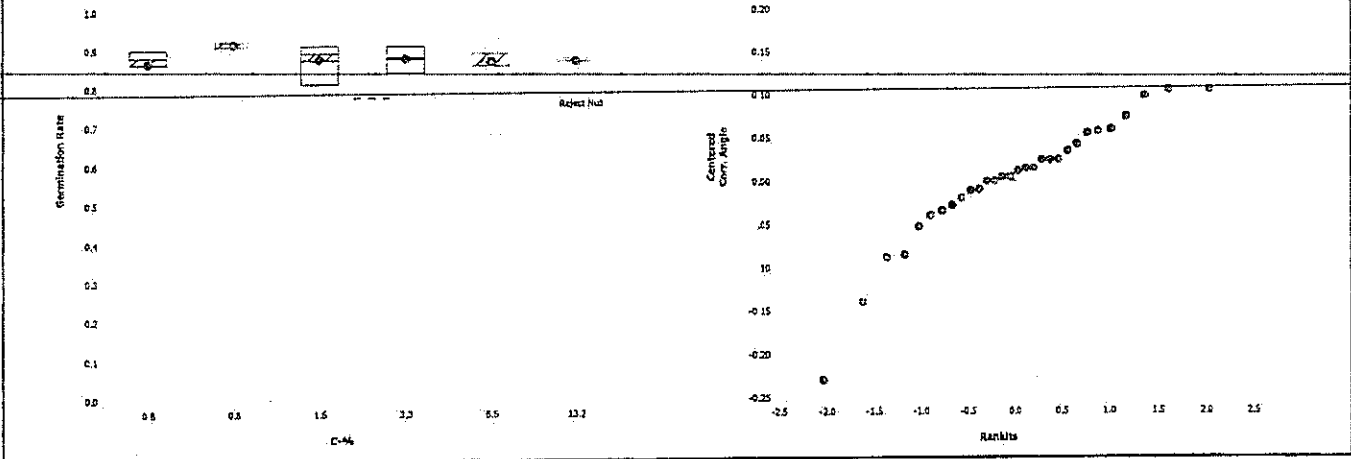

CETIS Analytical Report

Report Date: 07 Sep-16 15:48 (p 2 of 2)
 Test Code: 69596 | 15-1906-8524

Macrocystis Germination and Growth Test Pacific EcoRisk

Analysis ID: 02-9839-1281 Endpoint: Mean Length CETIS Version: CETISv1.8.7
 Analyzed: 07 Sep-16 15:35 Analysis: Parametric-Control vs Treatments Official Results: Yes

Data Transform	Zeta	Alt Hyp	Trials	Seed	PMSD	NOEL	LOEL	TOEL	TU
Untransformed	NA	C > T	NA	NA	6.41%	13.2	>13.2	NA	7.576

Dunnett Multiple Comparison Test

Control	vs C-%	Test Stat	Critical	MSD	DF	P-Value	P-Type	Decision(α:5%)
Brine Control	0.8	-4.19	2.36	0.947	8	1.0000	CDF	Non-Significant Effect
	1.6	-2.59	2.36	0.947	8	0.9999	CDF	Non-Significant Effect
	3.3	-1.5	2.36	0.947	8	0.9962	CDF	Non-Significant Effect
	6.6	1.1	2.36	0.947	8	0.3772	CDF	Non-Significant Effect
	13.2	2.05	2.36	0.947	8	0.0915	CDF	Non-Significant Effect

ANOVA Table

Source	Sum Squares	Mean Square	DF	F Stat	P-Value	Decision(α:5%)
Between	22.11367	4.422733	5	11	<0.0001	Significant Effect
Error	9.639999	0.4016666	24			
Total	31.75367		29			

Distributional Tests

Attribute	Test	Test Stat	Critical	P-Value	Decision(α:1%)
Variances	Bartlett Equality of Variance	10.2	15.1	0.0706	Equal Variances
Distribution	Shapiro-Wilk W Normality	0.949	0.903	0.1626	Normal Distribution

Mean Length Summary

C-%	Control Type	Count	Mean	95% LCL	95% UCL	Median	Min	Max	Std Err	CV%	%Effect
0	Brine Control	5	14.8	14.1	15.5	14.8	14	15.3	0.248	3.75%	0.0%
0.8		5	16.5	15.6	17.3	16.5	15.8	17.5	0.294	4.0%	-11.4%
1.6		5	15.8	14.9	16.7	15.5	15.3	17	0.322	4.55%	-7.04%
3.3		5	15.4	15.2	15.5	15.3	15.3	15.5	0.049	0.71%	-4.06%
6.6		5	14.3	13.5	15.2	14	13.8	15.3	0.303	4.72%	2.98%
13.2		5	14	12.9	15	14	13	15	0.37	5.92%	5.55%

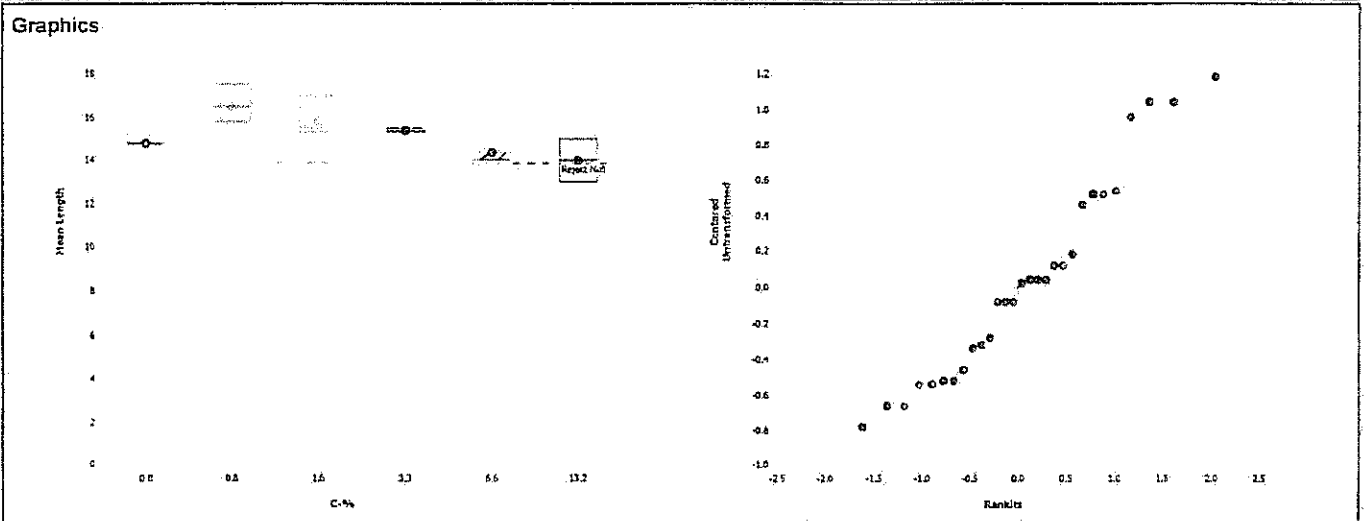

CETIS Analytical Report

Report Date: 06 Sep-16 15:20 (p 2 of 2)
 Test Code: 69596 | 15-1905-8524

Macrocystis Germination and Growth Test			Pacific EcoRisk		
Analysis ID: 02-4914-4477	Endpoint: Mean Length	CETIS Version: CETISv1.8.7			
Analyzed: 06 Sep-16 15:20	Analysis: Linear Interpolation (ICPIN)	Official Results: Yes			

Linear Interpolation Options					
X Transform	Y Transform	Seed	Resamples	Exp 95% CL	Method
Linear	Linear	1239889	200	Yes	Two-Point Interpolation

Point Estimates						
Level	%	95% LCL	95% UCL	TU	95% LCL	95% UCL
IC5	4.82	3.29	8.58	20.77	11.65	30.39
IC10	10.5	3.67	N/A	9.564	NA	27.25
IC15	>13.2	N/A	N/A	<7.576	NA	NA
IC20	>13.2	N/A	N/A	<7.576	NA	NA
IC25	>13.2	N/A	N/A	<7.576	NA	NA
IC40	>13.2	N/A	N/A	<7.576	NA	NA
IC50	>13.2	N/A	N/A	<7.576	NA	NA

Mean Length Summary			Calculated Variate						
C-%	Control Type	Count	Mean	Min	Max	Std Err	Std Dev	CV%	%Effect
0	Brine Control	5	14.8	14	15.3	0.248	0.554	3.75%	0.0%
0.8		5	16.5	15.8	17.5	0.294	0.658	4.0%	-11.4%
1.6		5	15.8	15.3	17	0.322	0.719	4.55%	-7.04%
3.3		5	15.4	15.3	15.5	0.049	0.11	0.71%	-4.06%
6.6		5	14.3	13.8	15.3	0.303	0.677	4.72%	2.98%
13.2		5	14	13	15	0.37	0.826	5.92%	5.55%

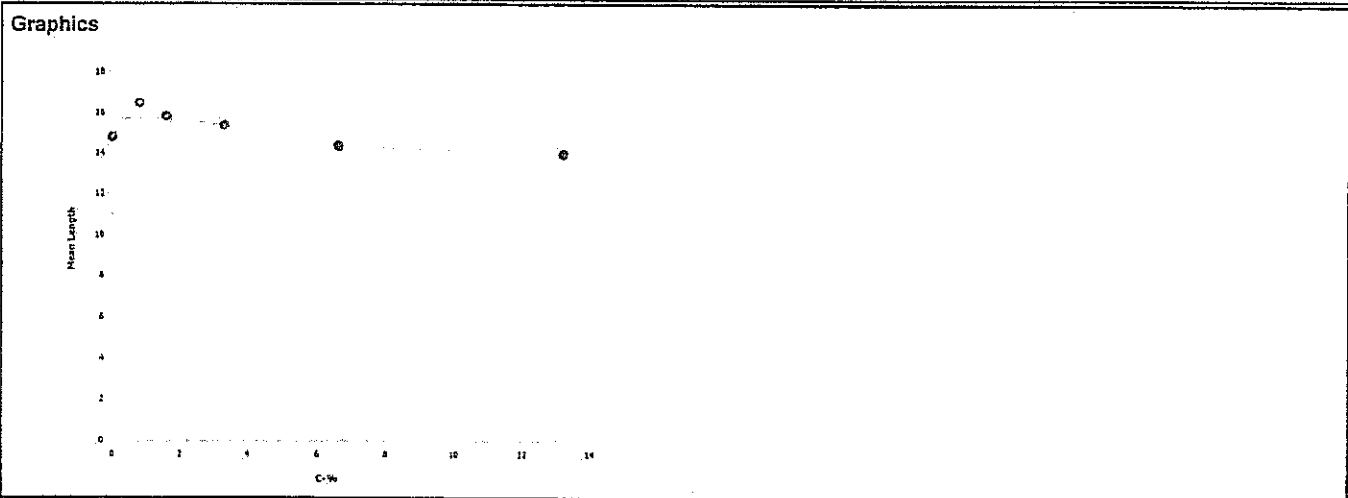

CETIS Analytical Report

Report Date: 06 Sep-16 15:20 (p 3 of 3)
 Test Code: 69596 | 15-1906-8524

Macrocystis Germination and Growth Test Pacific EcoRisk

Analysis ID: 09-2032-8949 Endpoint: Germination Rate CETIS Version: CETISv1.8.7
 Analyzed: 06 Sep-16 15:20 Analysis: Parametric-Two Sample Official Results: Yes

Data Transform	Zeta	Alt Hyp	Trials	Seed	PMSD	Test Result
Angular (Corrected)	NA	C > T	NA	NA	3.13%	Fails germination rate

Equal Variance t Two-Sample Test

Control	vs Control	Test Stat	Critical	MSD	DF	P-value	P-Type	Decision(α:5%)
Lab Water Control	Brine Control	3.23	1.86	0.049	8	0.0061	CDF	Significant Effect

ANOVA Table

Source	Sum Squares	Mean Square	DF	F Stat	P-Value	Decision(α:5%)
Between	0.01788116	0.01788116	1	10.4	0.0121	Significant Effect
Error	0.01374114	0.001717642	8			
Total	0.03162229		9			

Distributional Tests

Attribute	Test	Test Stat	Critical	P-Value	Decision(α:1%)
Variances	Variance Ratio F	7.2	23.2	0.0821	Equal Variances
Distribution	Shapiro-Wilk W Normality	0.928	0.741	0.4331	Normal Distribution

Germination Rate Summary

C-%	Control Type	Count	Mean	95% LCL	95% UCL	Median	Min	Max	Std Err	CV%	%Effect
0	Lab Water Contr	5	0.915	0.902	0.93	0.92	0.9	0.93	0.0051	1.24%	0.0%
0	Brine Control	5	0.862	0.814	0.91	0.88	0.8	0.9	0.0174	4.52%	5.9%

Angular (Corrected) Transformed Summary

C-%	Control Type	Count	Mean	95% LCL	95% UCL	Median	Min	Max	Std Err	CV%	%Effect
0	Lab Water Cont	5	1.28	1.25	1.3	1.28	1.25	1.3	0.00916	1.6%	0.0%
0	Brne Control	5	1.19	1.12	1.26	1.22	1.11	1.25	0.0246	4.6%	6.62%

Graphics

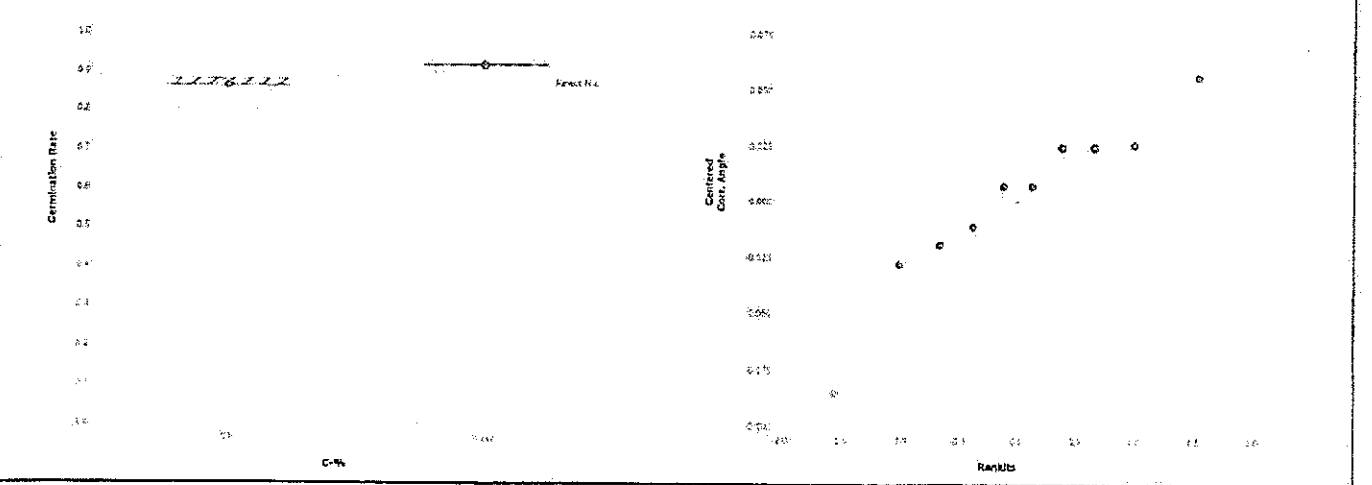

CETIS Analytical Report

Report Date: 07 Sep-16 15:48 (p 1 of 2)
 Test Code: 69596 | 15-1906-8524

Macrocystis Germination and Growth Test Pacific EcoRisk

Analysis ID: 06-8014-1444 Endpoint: Mean Length CETIS Version: CETISv1.8.7
 Analyzed: 07 Sep-16 15:35 Analysis: Parametric-Two Sample Official Results: Yes

Data Transform	Zeta	Alt Hyp	Trials	Seed	PMSD	Test Result
Untransformed	NA	C > T	NA	NA	3.48%	Fails mean length

Equal Variance t Two-Sample Test

Control	vs Control	Test Stat	Critical	MSD	DF	P-Value	P-Type	Decision(α:5%)
Lab Water Control	Brine Control	6.04	1.86	0.579	8	0.0002	CDF	Significant Effect

ANOVA Table

Source	Sum Squares	Mean Square	DF	F Stat	P-Value	Decision(α:5%)
Between	8.835998	8.835998	1	36.4	0.0003	Significant Effect
Error	1.94	0.2425	8			
Total	10.776		9			

Distributional Tests

Attribute	Test	Test Stat	Critical	P-Value	Decision(α:1%)
Variances	Variance Ratio F	1.72	23.2	0.6104	Equal Variances
Distribution	Shapiro-Wilk W Normality	0.916	0.741	0.3254	Normal Distribution

Mean Length Summary

C-%	Control Type	Count	Mean	95% LCL	95% UCL	Median	Min	Max	Std Err	CV%	%Effect
0	Lab Water Contr	5	16.7	16.1	17.2	16.8	16	17	0.189	2.53%	0.0%
0	Brine Control	5	14.8	14.1	15.5	14.8	14	15.3	0.248	3.75%	11.3%

Graphics

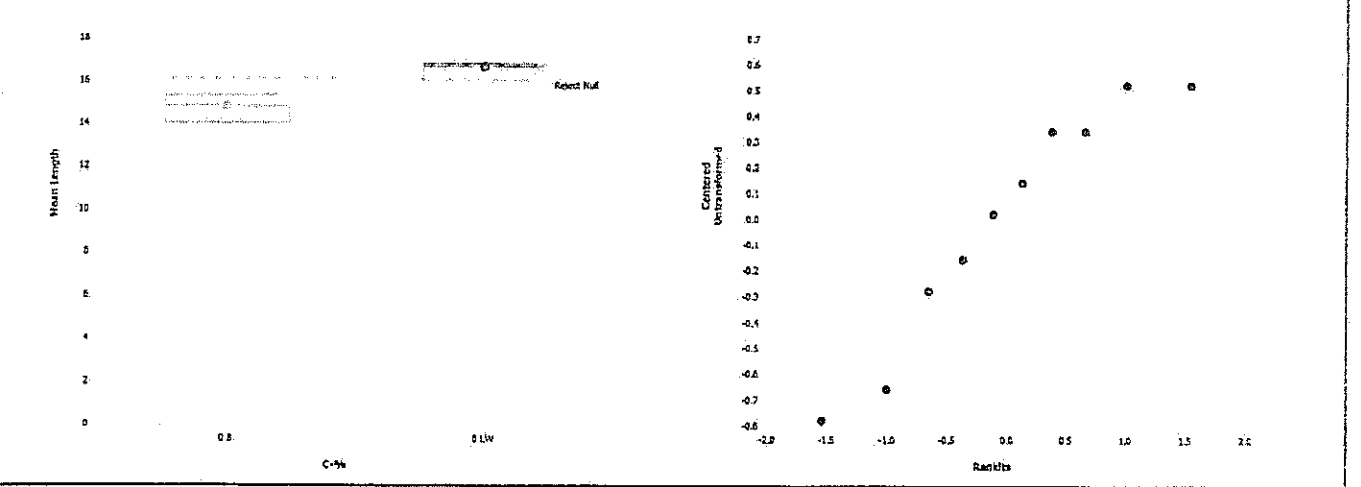

CETIS Analytical Report

Report Date: 13 Sep-16 16:52 (p 1 of 2)
 Test Code: 69596 | 15-1906-8524

Macrocystis Germination and Growth Test Pacific EcoRisk

Analysis ID: 18-0677-7428 Endpoint: Germination Rate CETIS Version: CETISv1.6.7
 Analyzed: 13 Sep-16 16:52 Analysis: Parametric Bioequivalence-Two Sample Official Results: Yes

Data Transform	Zeta	Alt Hyp	Trials	Seed	TST b	PMSD	Test Result
Angular (Corrected)	NA	C*b < T	NA	NA	0.75	3.78%	Passes germination rate

TST-Welch's t Test

Control	vs C-%	Test Stat	Critical	MSD	DF	P-Value	P-Type	Decision(α:5%)
Brine Control	3.3*	12.6	1.89	0.048	7	<0.0001	CDF	Non-Significant Effect

ANOVA Table

Source	Sum Squares	Mean Square	DF	F Stat	P-Value	Decision(α:5%)
Between	0.0009608919	0.0009608919	1	0.429	0.5309	Non-Significant Effect
Error	0.01792314	0.002240393	8			
Total	0.01888404		9			

Distributional Tests

Attribute	Test	Test Stat	Critical	P-Value	Decision(α:1%)
Variances	Variance Ratio F	2.06	23.2	0.5014	Equal Variances
Distribution	Shapiro-Wilk W Normality	0.946	0.741	0.6256	Normal Distribution

Germination Rate Summary

C-%	Control Type	Count	Mean	95% LCL	95% UCL	Median	Min	Max	Std Err	CV%	%Effect
0	Brine Control	5	0.862	0.814	0.91	0.88	0.8	0.9	0.0174	4.52%	0.0%
3.3		5	0.876	0.845	0.907	0.88	0.84	0.91	0.0112	2.87%	-1.62%

Angular (Corrected) Transformed Summary

C-%	Control Type	Count	Mean	95% LCL	95% UCL	Median	Min	Max	Std Err	CV%	%Effect
0	Brine Control	5	1.19	1.12	1.26	1.22	1.11	1.25	0.0246	4.6%	0.0%
3.3		5	1.21	1.16	1.26	1.22	1.16	1.27	0.0171	3.16%	-1.64%

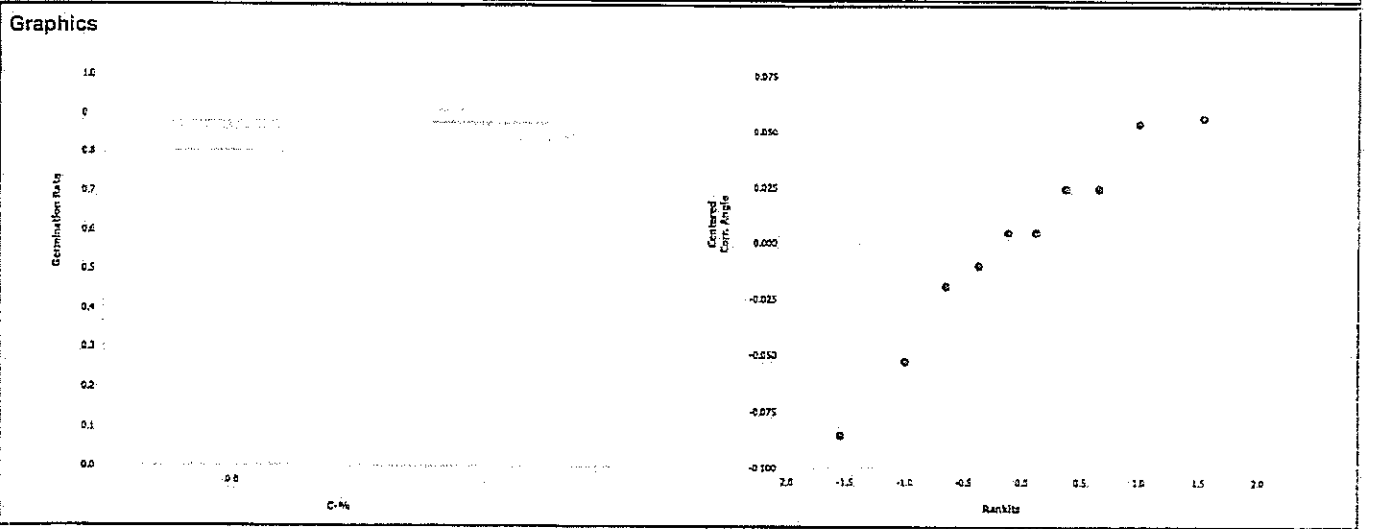

CETIS Analytical Report

Report Date: 13 Sep-16 16:52 (p 2 of 2)
 Test Code: 69596 | 15-1906-8524

Macrocystis Germination and Growth Test Pacific EcoRisk

Analysis ID: 09-8435-5283 Endpoint: Mean Length CETIS Version: CETISv1.8.7
 Analyzed: 13 Sep-16 16:52 Analysis: Parametric Bioequivalence-Two Sample Official Results: Yes

Data Transform	Zeta	Alt Hyp	Trials	Seed	TST b	PMSD	Test Result
Untransformed	NA	C*b < T	NA	NA	0.75	2.77%	Passes mean length

TST-Welch's t Test

Control	vs	G-%	Test Stat	Critical	MSD	DF	P-Value	P-Type	Decision(α:5%)
Brine Control		3.3*	22.3	2.13	0.41	4	<0.0001	CDF	Non-Significant Effect

ANOVA Table

Source	Sum Squares	Mean Square	DF	F Stat	P-Value	Decision(α:5%)
Between	0.9	0.9	1	5.64	0.0449	Significant Effect
Error	1.276	0.1595	8			
Total	2.176		9			

Distributional Tests

Attribute	Test	Test Stat	Critical	P-Value	Decision(α:1%)
Variances	Variance Ratio F	25.6	23.2	0.0083	Unequal Variances
Distribution	Shapiro-Wilk W Normality	0.915	0.741	0.3160	Normal Distribution

Mean Length Summary

C-%	Control Type	Count	Mean	95% LCL	95% UCL	Median	Min	Max	Std Err	CV%	%Effect
0	Brine Control	5	14.8	14.1	15.5	14.8	14	15.3	0.248	3.75%	0.0%
3.3		5	15.4	15.2	15.5	15.3	15.3	15.5	0.049	0.71%	-4.06%

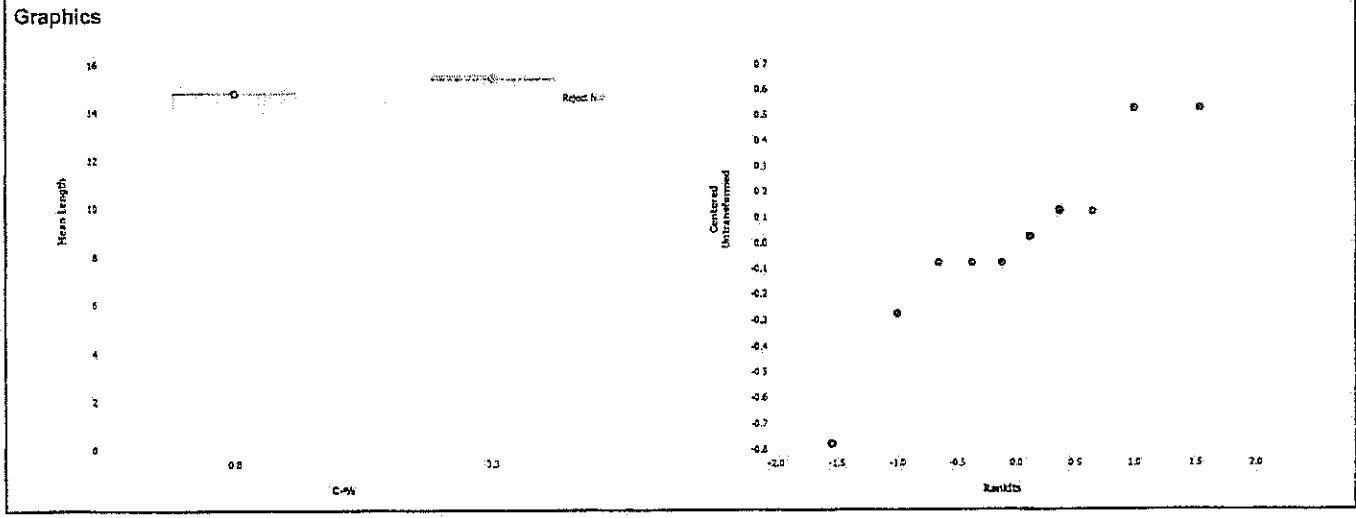

Kelp (*M. pyrifera*) Development Toxicity Test Water Chemistry Data

Client: Crescent City
 Test Material: Effluent
 Test ID#: 69596 Project #: 26221
 Test Date: 8-31-16 Randomization: 7-5-1
 Sample Salinity adjusted with: Hyper Saline Brine

Organism Log#: 9783 Age: N/A
 Organism Supplier: Catoff
 Control/Diluent: 0.2 µm Filtered Seawater
 Light Intensity: 229

Day 0					
Treatment	Temperature (°C)	pH	D.O. (mg/L)	Salinity (ppt)	Signoff
Lab Control	15.0	7.42	10.0	32.8	Sample ID: <u>239167</u>
0.8%	15.0	7.51	10.2	32.9	Test Solution Prep: <u>W</u>
1.6%	15.0	7.56	10.4	32.6	New WQ: <u>SD</u>
3.3%	15.0	7.58	10.5	32.8	Inoculation Date: <u>8/31/16</u>
6.6%	15.0	7.60	10.5	32.9	Inoculation Time: <u>1551</u>
13.2%	15.0	7.62	10.4	33.0	Inoculation Signoff: <u>W</u>
Meter ID	32A	PH21	RD12	EU1	

Day 1					
Treatment	Temperature (°C)	pH	D.O. (mg/L)	Salinity (ppt)	Signoff
Lab Control	14.7				Date: <u>9/1/16</u>
0.8%	14.7				Old WQ: <u>W</u>
1.6%	14.7				
3.3%	14.7				
6.6%	14.7				
13.2%	14.7				
Meter ID	32A				

Day 2					
Treatment	Temperature (°C)	pH	D.O. (mg/L)	Salinity (ppt)	Signoff
Lab Control	14.9	7.65	7.9	32.0	Termination Time: <u>9-2-16 1540</u>
0.8%	14.9	7.67	7.9	32.8	Termination Signoff: <u>ACE</u>
1.6%	14.9	7.73	8.0	33.0	Old WQ: <u>HR</u>
3.3%	14.9	7.76	8.0	33.1	
6.6%	14.9	7.78	8.0	32.8	
13.2%	14.9	7.80	8.1	33.4	
Meter ID	32A	PH23	RD11	EU09	

Kelp (*M. pyrifera*) Development Toxicity Test Water Chemistry Data

Client: Crescent City
 Test Material: Control Waters
 Test ID#: 69596 Project #: 26221
 Test Date: 8/31/16

Organism Log#: 9783 Age: N/A
 Organism Supplier: (Sustall)
 Control/Diluent: Filtered Seawater

Sample Salinity adjusted with: HSB

Day 0					
Treatment	Temperature (°C)	pH	D.O. (mg/L)	Salinity (ppt)	Signoff
Lab Water Control	15.0	7.42	10.0	32.8	Date & Inoculation Time: <u>8/31/16</u>
Brine Control	15.0	7.60	9.1	32.8	Solution Prep/Inoculation: <u>MS</u>
Meter ID	32A	PH21	RD12	EC11	New WQ: <u>SD</u>

Day 1					
Treatment	Temperature (°C)	pH	D.O. (mg/L)	Salinity (ppt)	Signoff
Lab Water Control	14.2				Date: <u>9/1/16</u>
Brine Control	14.2				Old WQ: <u>DM</u>
Meter ID	32A				

Day 2					
Treatment	Temperature (°C)	pH	D.O. (mg/L)	Salinity (ppt)	Signoff
Lab Water Control	14.9	7.60	7.9	32.0	Date: <u>9/2/16</u>
Brine Control	14.9	7.81	7.8	32.5	Termination: <u>ARF</u>
Meter ID	14.9	PH23	RD11	EC09	Old WQ: <u>MR</u>

Kelp (*M. pyrifera*) Development Toxicity Test Data

Client: Crescent City Test Start Date: 8/31/16 Test End Date: 9-2-16 Enumeration Date: 9/5/16
 Test Material: Effluent Test ID #: 69596 Project #: 26221 Investigator: JL
 Control Medium: 0.2 µm filtered SW Sample salinity adjusted with: Hyper Saline Brine Micrometer Conv. Factor: 2.5

KCl (g/L)	Rep	Germination		Length Measurements (in ocular micrometer units)										MEAN	Corrected Mean Length (µm)
		# Spores Germinated	# Spores not Germinated	L1	L2	L3	L4	L5	L6	L7	L8	L9	L10		
Lab Control	A	92	8	7	6	7	6	8	8	8	7	5	6	6.8	17.0
	B	90	10	6	5	8	9	8	6	6	5	6	7	6.6	16.5
	C	92	8	7	8	6	7	7	8	5	5	7	7	6.7	16.8
	D	93	7	6	5	6	8	7	8	8	6	7	7	6.9	17.0
	E	91	9	5	8	8	6	7	7	7	8	7	9	6.4	16.0
0.8%	A	46	4	8	7	5	7	6	6	5	6	7	7	7.0	17.5
	B	92	8	6	7	8	7	8	6	8	9	5	6	6.6	16.5
	C	82	18	6	7	8	6	5	5	7	7	7	8	6.6	16.5
	D	89	11	6	5	5	7	8	7	7	7	5	7	6.4	16.0
	E	95	5	6	5	7	5	7	5	7	6	7	8	6.3	15.8
1.6%	A	81	19	9	5	5	6	6	9	5	7	8	8	6.9	17.0
	B	89	11	5	5	6	6	6	7	8	7	6	6	6.2	15.5
	C	91	9	7	7	7	7	5	5	6	8	5	7	6.4	16.0
	D	90	10	7	5	6	7	6	5	6	7	5	7	6.1	15.3
	E	85	15	6	6	6	6	6	7	8	5	5	6	6.1	15.3
3.3%	A	91	9	6	6	6	8	7	5	7	5	5	6	6.1	15.3
	B	87	13	6	8	5	5	7	7	8	5	6	5	6.2	15.5
	C	88	12	7	7	7	7	6	5	6	6	6	5	6.2	15.5
	D	84	16	7	5	5	6	6	8	7	7	5	5	6.1	15.3
	E	88	12	7	6	6	7	7	7	6	5	5	5	6.1	15.3
6.6%	A	89	11	5	6	5	7	7	7	5	6	8	5	6.1	15.3
	B	93	7	5	6	6	4	4	5	7	6	6	6	5.5	13.8
	C	68	32	7	5	8	4	5	5	7	7	6	5	5.9	14.8
	D	86	14	7	7	6	5	7	5	4	4	6	5	5.6	14.0
	E	93	7	6	6	7	7	3	5	7	5	4	5	5.5	13.8
13.2%	A	88	12	7	5	4	5	6	4	7	6	5	4	5.3	13.3
	B	85	15	5	5	7	8	5	6	5	5	6	6	5.8	14.5
	C	88	12	7	6	6	6	4	6	5	3	5	6	5.2	13.0
	D	87	13	6	5	7	6	5	8	5	7	4	3	5.6	14.0
	E	82	13	7	7	4	5	7	7	7	6	6	4	6.0	15.0

Keip (*M. pyrifera*) Development Toxicity Test Data

Client: Crescent City Test Start Date: 8-31-16 Test End Date: 9-2-16 Enumeration Date: 9/5/16
 Test Material: Effluent Test ID #: 69596 Project #: 26221 Investigator: JL
 Control Medium: Filtered Seawater Sample salinity adjusted with: Hyper-Saline Brine Micrometer Conv. Factor: 2.5

Treatment	Rep.	Germination		Length Measurements (in ocular micrometer units)										MEAN	Corrected Mean Length (µm)
		# Spores Germinated	# Spores not Germinated	11	12	13	14	15	16	17	18	19	20		
Lab Water Control	A	92	8	7	6	7	6	8	9	8	7	5	6	6.8	17.0
	B	90	10	6	5	8	9	8	6	6	5	6	7	6.6	16.5
	C	92	8	7	8	6	7	7	8	5	5	7	7	6.7	16.8
	D	93	7	6	5	6	8	7	8	8	6	7	7	6.8	17.0
	E	91	9	5	8	8	6	7	7	7	8	7	9	6.4	16.0
Brine Control	A	88	12	5	8	8	6	5	5	5	6	7	6	6.1	15.3
	B	80	20	7	5	5	5	7	5	6	6	5	5	5.6	14.0
	C	85	15	5	6	5	8	6	6	7	6	7	5	6.1	15.3
	D	88	12	5	5	7	6	8	7	7	5	3	6	5.9	14.8
	E	90	10	6	8	5	5	5	5	4	6	7	7	5.8	14.5

Appendix C

Test Data and Summary of Statistics for the Reference Toxicant Evaluation of the Giant Kelp *Macrocystis pyrifera*

CETIS Summary Report

Report Date: 07 Sep-16 16:14 (p 1 of 2)
 Test Code: 69588 | 03-6551-7287

Macrocystis Germination and Growth Test Pacific EcoRisk

Batch ID: 20-8093-1700	Test Type: Growth-Germination	Analyst: Simin Delijani
Start Date: 31 Aug-16 16:05	Protocol: EPA/600/R-95/136 (1995)	Diluent: Filtered Seawater
Ending Date: 02 Sep-16 15:35	Species: Macrocystis pyrifera	Brine: Not Applicable
Duration: 47h	Source: Gutoff	Age: N/A

Sample ID: 00-8947-1580	Code: KCI	Client: Reference Toxicant
Sample Date: 31 Aug-16 16:05	Material: Potassium chloride	Project: 25236

Receive Date: 31 Aug-16 16:05	Source: Reference Toxicant
Sample Age: NA (15 °C)	Station: In House

Comparison Summary

Analysis ID	Endpoint	NOEL	LOEL	TOEL	PMSD	TU	Method
01-7528-8540	Germination Rate	4	8	5.657	4.97%		Dunnett Multiple Comparison Test
05-1312-9784	Mean Length	<2	2	NA	4.31%		Dunnett Multiple Comparison Test

Point Estimate Summary

Analysis ID	Endpoint	Level	g/L	95% LCL	95% UCL	TU	Method
05-7679-8857	Germination Rate	EC5	3.35	2.61	4		Linear Regression (MLE)
		EC10	3.91	3.14	4.56		
		EC15	4.34	3.57	4.98		
		EC20	4.71	3.94	5.35		
		EC25	5.05	4.29	5.69		
		EC40	6.04	5.31	6.66		
		EC50	6.72	6.02	7.33		
10-3666-3014	Mean Length	IC5	1.66	0.971	5.76		Linear Interpolation (ICPIN)
		IC10	5.17	4.09	7.3		
		IC15	6.63	5.36	9.4		
		IC20	8.12	6.42	10.3		
		IC25	9.93	7.65	11.5		
		IC40	15.8	14.3	16.9		
		IC50	18.5	17.6	19.4		

Germination Rate Summary

C-g/L	Control Type	Count	Mean	95% LCL	95% UCL	Min	Max	Std Err	Std Dev	CV%	%Effect
0	Lab Water Contr	5	0.838	0.805	0.871	0.82	0.88	0.012	0.0268	3.2%	0.0%
2		5	0.858	0.819	0.897	0.83	0.9	0.0139	0.0311	3.63%	-2.39%
4		5	0.858	0.83	0.886	0.83	0.88	0.0102	0.0228	2.65%	-2.39%
8		5	0.158	0.138	0.178	0.13	0.17	0.00735	0.0164	10.4%	81.1%
12		5	0.134	0.0982	0.17	0.11	0.17	0.0129	0.0288	21.5%	84.0%
16		5	0.022	0.0084	0.0356	0.01	0.04	0.0049	0.011	49.8%	97.4%
32		5	0	0	0	0	0	0	0		100.0%

Mean Length Summary

C-g/L	Control Type	Count	Mean	95% LCL	95% UCL	Min	Max	Std Err	Std Dev	CV%	%Effect
0	Lab Water Contr	5	16	15.4	16.5	15.5	16.5	0.204	0.456	2.86%	0.0%
2		5	14.9	14.2	15.6	14	15.5	0.26	0.581	3.9%	6.77%
4		5	15.1	14.5	15.7	14.8	16	0.224	0.502	3.32%	5.26%
8		5	12.8	11.4	14.2	11.8	14.8	0.513	1.15	8.95%	19.7%
12		5	11.1	10.2	11.9	10.3	12	0.314	0.702	6.35%	30.7%
16		5	9.48	8.9	10.1	8.8	10	0.208	0.466	4.91%	40.6%
32		5	0	0	0	0	0	0	0		100.0%

CETIS Summary Report

Report Date: 07 Sep-16 16:14 (p 2 of 2)
 Test Code: 69588 | 03-6551-7287

Macrocystis Germination and Growth Test							Pacific EcoRisk
Germination Rate Detail							
C-g/L	Control Type	Rep 1	Rep 2	Rep 3	Rep 4	Rep 5	
0	Lab Water Contr	0.85	0.88	0.82	0.82	0.82	
2		0.83	0.85	0.88	0.83	0.9	
4		0.84	0.88	0.86	0.83	0.88	
8		0.16	0.16	0.13	0.17	0.17	
12		0.16	0.17	0.11	0.12	0.11	
16		0.04	0.01	0.02	0.02	0.02	
32		0	0	0	0	0	
Mean Length Detail							
C-g/L	Control Type	Rep 1	Rep 2	Rep 3	Rep 4	Rep 5	
0	Lab Water Contr	15.5	16	16.3	16.5	15.5	
2		15.3	14	14.8	14.8	15.5	
4		14.8	15	14.8	15	16	
8		12.5	12.5	11.8	12.5	14.8	
12		12	11.5	11	10.5	10.3	
16		9.8	8.8	9.5	9.3	10	
32		0	0	0	0	0	
Germination Rate Binomials							
C-g/L	Control Type	Rep 1	Rep 2	Rep 3	Rep 4	Rep 5	
0	Lab Water Contr	85/100	88/100	82/100	82/100	82/100	
2		83/100	85/100	88/100	83/100	90/100	
4		84/100	88/100	86/100	83/100	88/100	
8		16/100	16/100	13/100	17/100	17/100	
12		16/100	17/100	11/100	12/100	11/100	
16		4/100	1/100	2/100	2/100	2/100	
32		0/100	0/100	0/100	0/100	0/100	

Macrocyctis Germination and Growth Test

Pacific EcoRisk

Test Type: Growth-Germination Organism: Macrocyctis pyrifera (Giant Kelp) Material: Potassium chloride
 Protocol: EPA/600/R-95/136 (1995) Endpoint: Mean Length Source: Reference Toxicant-REF

Macrocyctis Germination and Growth Test

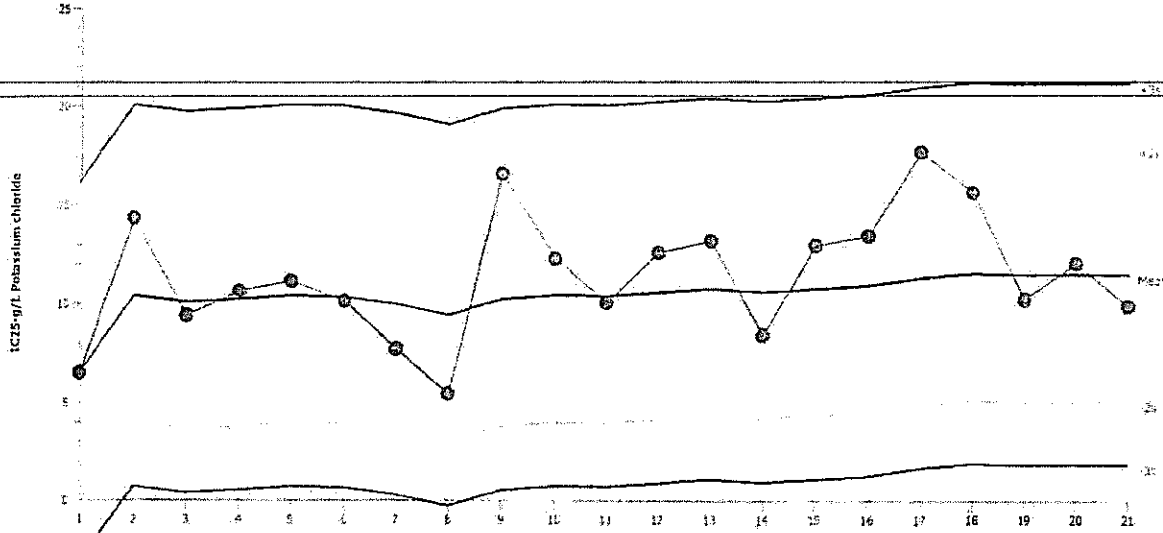

Mean: 11.56 Count: 20 -2s Warning Limit: 5.1 -3s Action Limit: 1.871
 Sigma: 3.229 CV: 27.90% +2s Warning Limit: 18.02 +3s Action Limit: 21.25

Quality Control Data

Point	Year	Month	Day	Time	QC Data	Delta	Sigma	Warning	Action	Test ID	Analysis ID
1	2014	Sep	26	16:16	6.514	-5.046	-1.563			10-1363-0372	09-2501-0092
2		Nov	14	14:42	14.35	2.793	0.865			05-8406-7629	14-0145-0588
3		Dec	11	17:47	9.407	-2.153	-0.6669			06-3674-9917	03-1545-1560
4	2015	Feb	4	15:12	10.67	-0.8911	-0.276			01-8953-9417	15-3725-7494
5			11	17:05	11.19	-0.3677	-0.1139			00-6859-6632	05-1990-8292
6		Mar	26	15:27	10.17	-1.39	-0.4304			14-4111-2465	01-6620-2006
7		Apr	10	15:00	7.733	-3.827	-1.185			00-4546-7083	13-6601-4182
8			21	16:05	5.462	-6.098	-1.889			03-8790-5000	07-1454-1082
9		Aug	19	16:05	16.63	5.068	1.57			00-8038-7597	02-4787-3597
10		Sep	17	16:29	12.32	0.7579	0.2347			04-3239-9760	02-3980-1049
11			29	15:19	10.08	-1.476	-0.4572			18-0573-6207	13-4305-3927
12		Oct	14	16:20	12.63	1.074	0.3328			17-5745-2582	04-0174-8566
13	2016	Feb	11	17:57	13.23	1.675	0.5186			02-2002-4116	12-7156-0426
14			24	15:16	8.427	-3.133	-0.9702			14-6182-9064	03-9577-8450
15		Mar	24	15:38	13	1.442	0.4466			13-0997-3236	02-9744-4108
16		May	11	16:59	13.48	1.921	0.5948			06-3859-4233	01-7311-8088
17			17	16:15	17.75	6.189	1.917			06-9642-0474	15-6784-5098
18		Jun	8	17:25	15.71	4.15	1.285			17-1352-1021	02-1666-9355
19		Jul	20	16:10	10.27	-1.293	-0.4005			17-7162-8612	07-8845-1726
20		Aug	17	17:10	12.13	0.5694	0.1763			18-5238-8317	08-8084-7524
21			31	16:05	9.932	-1.628	-0.5042			03-6551-7287	10-3666-3014

CETIS QC Plot

Report Date: 07 Sep-16 16:19 (1 of 1)

Macrocyctis Germination and Growth Test		Pacific EcoRisk	
Test Type: Growth-Germination	Organism: Macrocyctis pyrifera (Giant Kelp)	Material: Potassium chloride	
Protocol: EPA/600/R-95/136 (1995)	Endpoint: Germination Rate	Source: Reference Toxicant-REF	

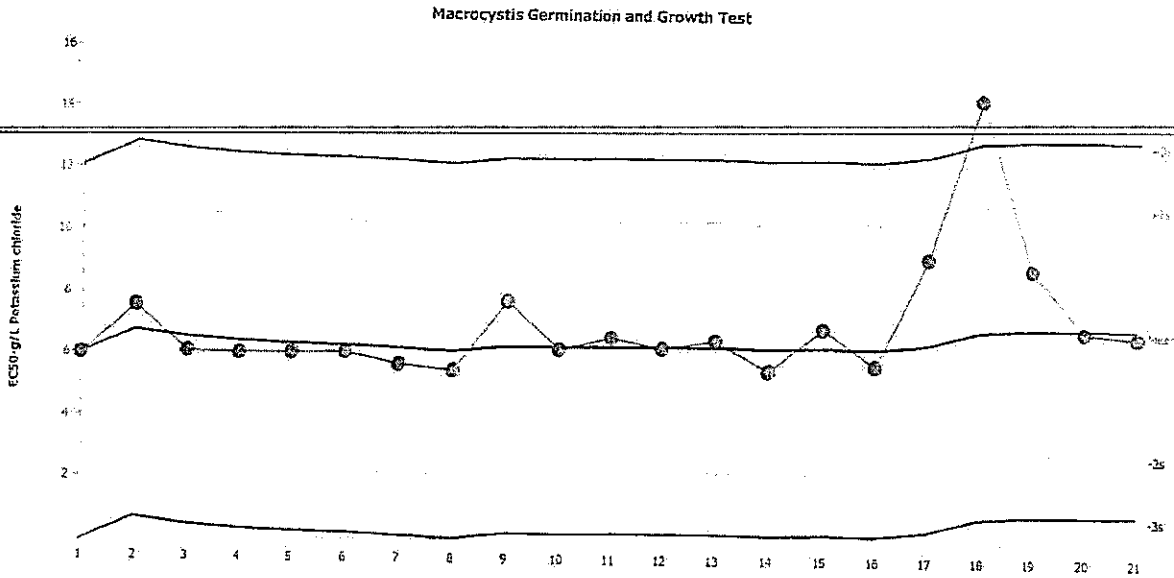

Mean: 6.997 Count: 20 -2s Warning Limit: 2.941 -3s Action Limit: 0.9128
 Sigma: 2.028 CV: 29.00% +2s Warning Limit: 11.05 +3s Action Limit: 13.08

Quality Control Data

Point	Year	Month	Day	Time	QC Data	Delta	Sigma	Warning	Action	Test ID	Analysis ID
1	2014	Sep	26	16:16	5.97	-1.027	-0.5066			10-1363-0372	11-5475-5741
2		Nov	14	14:42	7.556	0.5591	0.2757			05-8406-7629	08-9262-7840
3		Dec	11	17:47	6.069	-0.9282	-0.4577			06-3674-9917	17-6928-0916
4	2015	Feb	4	15:12	6.021	-0.9763	-0.4814			01-8953-9417	04-4584-8875
5			11	17:05	6.037	-0.9601	-0.4734			00-6859-8632	11-0740-3478
6		Mar	26	15:27	6.063	-0.9344	-0.4607			14-4111-2465	03-1249-4814
7		Apr	10	15:00	5.674	-1.323	-0.6523			00-4546-7083	00-3592-2978
8			21	16:05	5.495	-1.502	-0.7405			03-8790-5000	05-3114-2687
9		Aug	19	16:05	7.757	0.7598	0.3746			00-8038-7597	06-3517-6896
10		Sep	17	16:29	6.2	-0.7971	-0.393			04-3239-9760	11-0821-6592
11			29	15:19	6.603	-0.3941	-0.1943			18-0573-6207	18-1298-6802
12		Oct	14	16:20	6.263	-0.7337	-0.3618			17-5745-2582	12-8310-9011
13	2016	Feb	11	17:57	6.538	-0.4591	-0.2264			02-2002-4116	14-7721-4486
14			24	15:16	5.567	-1.43	-0.7052			14-6182-9064	09-1770-7016
15		Mar	24	15:38	6.945	-0.0518	-0.02554			13-0997-3236	10-5433-4188
16		May	11	16:59	5.746	-1.251	-0.6167			06-3859-4233	17-4202-2030
17			17	16:15	9.231	2.234	1.101			06-9642-0474	03-5224-9353
18		Jun	8	17:25	14.4	7.403	3.65	(+)	(+)	17-1352-1021	14-8324-4382
19		Jul	20	16:10	8.902	1.905	0.9393			17-7162-8612	12-4837-0994
20		Aug	17	17:10	6.899	-0.0981	-0.04837			18-5238-8317	02-1528-3396
21			31	16:05	6.723	-0.2738	-0.135			03-6551-7287	05-7679-8857

Macrocystis Germination and Growth Test

Pacific EcoRisk

Test Type: Growth-Germination

Organism: *Macrocystis pyrifera* (Giant Kelp)

Material: Potassium chloride

Protocol: EPA/600/R-95/136 (1995)

Endpoint: Mean Length

Source: Reference Toxicant-REF

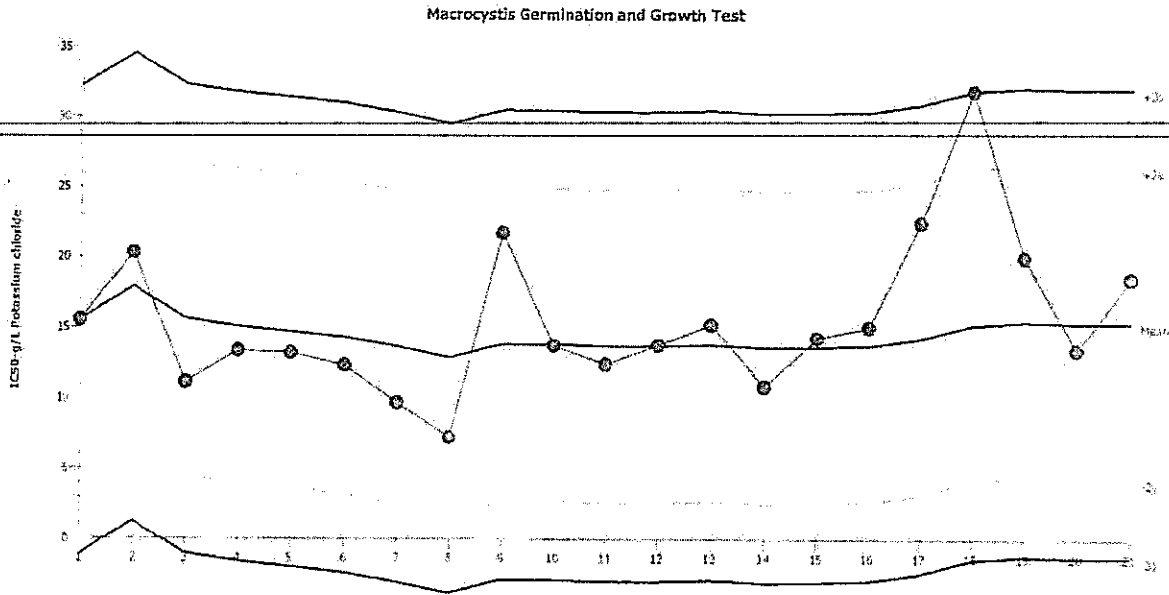

Mean: 15.38 Count: 20 -2s Warning Limit: 4.266 -3s Action Limit: -1.29
 Sigma: 5.556 CV: 36.10% +2s Warning Limit: 26.49 +3s Action Limit: 32.05

Quality Control Data

Point	Year	Month	Day	Time	QC Data	Delta	Sigma	Warning	Action	Test ID	Analysis ID
1	2014	Sep	26	16:16	15.56	0.1807	0.03252			10-1363-0372	09-2501-0092
2		Nov	14	14:42	20.34	4.956	0.892			05-8406-7629	14-0145-0588
3		Dec	11	17:47	11.11	-4.27	-0.7685			06-3674-9917	03-1545-1560
4	2015	Feb	4	15:12	13.34	-2.041	-0.3673			01-8953-9417	15-3725-7494
5			11	17:05	13.18	-2.196	-0.3952			00-6859-6632	05-1990-8292
6		Mar	26	15:27	12.3	-3.081	-0.5546			14-4111-2465	01-6620-2006
7		Apr	10	15:00	9.655	-5.725	-1.03			00-4546-7083	13-6601-4182
8			21	16:05	7.205	-8.175	-1.471			03-8790-5000	07-1454-1082
9		Aug	19	16:05	21.75	6.372	1.147			00-8038-7597	02-4787-3597
10		Sep	17	16:29	13.73	-1.65	-0.297			04-3239-9760	02-3980-1049
11			29	15:19	12.4	-2.982	-0.5366			18-0573-6207	13-4305-3927
12		Oct	14	16:20	13.76	-1.624	-0.2922			17-5745-2582	04-0174-8566
13	2016	Feb	11	17:57	15.24	-0.1412	-0.02542			02-2002-4116	12-7156-0426
14			24	15:16	10.82	-4.562	-0.8211			14-6182-9064	03-9577-8450
15		Mar	24	15:38	14.28	-1.104	-0.1987			13-0997-3236	02-9744-4108
16		May	11	16:59	15.07	-0.3096	-0.05572			06-3859-4233	01-7311-8088
17			17	16:15	22.5	7.119	1.281			06-9642-0474	15-6784-5098
18		Jun	8	17:25	31.88	16.5	2.97	(+)		17-1352-1021	02-1666-9355
19		Jul	20	16:10	20.03	4.649	0.8367			17-7162-8612	07-8845-1726
20		Aug	17	17:10	13.42	-1.96	-0.3528			18-5238-8317	08-8084-7524
21			31	16:05	18.53	3.152	0.5673			03-6551-7287	10-3666-3014

Kelp (*M. pyrifera*) Development Reference Toxicant Test Water Chemistry Data

Client: Reference Toxicant
 Test Material: Potassium chloride
 Test ID#: 69588 Project #: 26236
 Test Date: 8/31/16 Randomization: -

Organism Log#: 9783 Age: N/A
 Organism Supplier: GenBank
 Control/Diluent: Filtered Seawater
 Light Intensity: 224.4

Day 0					
Treatment (g KCl/L)	Temperature (°C)	pH	D.O. (mg/L)	Salinity (ppt)	Signoff
Lab Water Control	15.0	7.45	9.2	31.732.5	Test Solution Prep D
2	15.0	7.44	4.1	34.1	New WO: <u>50B</u>
4	15.0	7.54	9.1	36.0	Inoculation Date <u>8/31/16</u>
8	15.0	7.58	9.2	39.8	Inoculation Time <u>1605</u>
12	15.0	7.61	9.3	43.9	Inoculation Signoff D
16	15.0	7.63	9.2	48.1	
32	15.0	7.64	9.4	64.9	
Meter ID	32A	PH21	R004	EC08	

Day 1					
Treatment (g KCl/L)	Temperature (°C)	pH	D.O. (mg/L)	Salinity (ppt)	Signoff
Lab Water Control	14.7				Date <u>9/1/16</u>
2	14.7				Old WO <u>DM</u>
4	14.7				
8	14.7				
12	14.7				
16	14.7				
32	14.7				
Meter ID	32A				

Day 2					
Treatment (g KCl/L)	Temperature (°C)	pH	D.O. (mg/L)	Salinity (ppt)	Signoff
Lab Water Control	14.9	7.79	8.0	32.9	Termination Date <u>9/2/16</u> <u>DRF</u>
2	14.9	7.80	8.1	35.0	Termination Time <u>1535</u>
4	14.9	7.80	8.2	37.1	Termination Signoff <u>DRF</u>
8	14.9	7.82	8.1	41.3	Old WO <u>DM</u>
12	14.9	7.84	8.0	45.7	
16	14.9	7.85	8.0	50.3	
32	14.9	7.85	8.1	68.0	
Meter ID	32A	PH23	R011	EC09	

Kelp (*M. pyrifera*) Development Toxicity Test Data

Client: Reference Toxicant Test Start Date: 8/31/16 Test End Date: 9/12/16 Enumeration Date: 9/16/16
 Test Material: Potassium Chloride Test ID #: 69588 Project #: 26236 Investigator: JL
 Control Medium: Filtered Seawater Micrometer Conv. Factor: 2.5

KCl (g/L)	Rep	Germination		Length Measurements (in ocular micrometer units)										MEAN	Corrected Mean Length (mm)
		# Spores Germinated	# Spores not Germinated	L1	L2	L3	L4	L5	L6	L7	L8	L9	L10		
	A	85	15	7	6	7	4	6	6	7	6	8	5	6.2	15.5
	B	88	12	6	4	9	9	5	5	6	6	6	8	6.4	16.0
Lab Water Control	C	82	18	5	8	6	7	6	7	5	6	8	7	6.5	16.3
	D	82	18	6	5	7	7	7	5	7	7	8	7	6.6	16.5
	E	82	18	7	7	6	7	8	8	6	5	6	5	6.2	15.5
2	A	83	17	5	7	7	4	6	6	7	7	7	5	6.1	15.3
	B	85	15	5	5	7	5	7	5	5	8	4	5	5.6	14.0
	C	88	12	5	6	5	7	7	6	5	7	6	5	5.9	14.8
	D	83	17	6	5	6	6	7	6	5	6	7	5	5.9	14.8
	E	90	10	6	6	5	7	5	6	5	7	7	8	6.2	15.5
4	A	84	16	8	5	4	5	6	7	4	5	6	9	5.9	14.8
	B	88	12	4	5	6	7	7	6	7	5	6	7	6.0	15.0
	C	86	14	7	5	7	5	6	7	7	7	4	4	5.9	14.8
	D	83	17	6	6	7	5	6	6	8	4	5	7	6.0	15.0
	E	88	12	7	7	6	7	7	5	4	6	8	7	6.4	16.0
8	A	16	84	6	3	4	5	6	5	6	6	6	3	5.0	12.5
	B	16	84	5	3	3	3	7	6	5	6	6	6	5.0	12.5
	C	13	87	6	3	3	6	6	4	6	6	4	3	4.7	11.8
	D	17	83	5	7	5	4	5	5	3	3	7	6	5.0	12.5
	E	17	83	6	6	6	5	3	6	5	9	6	7	5.9	14.8
12	A	16	84	5	5	5	5	6	4	3	5	5	5	4.8	12.0
	B	17	83	3	5	3	5	3	6	4	6	5	6	4.6	11.5
	C	11	89	5	4	5	6	6	4	3	3	5	3	4.4	11.0
	D	12	88	4	4	3	4	3	4	5	5	4	6	4.2	10.5
	E	11	89	4	3	5	4	4	4	3	3	6	5	4.1	10.3
16	A	4	96	3	3	4	5	4	4	4	4	5	3	3.9	9.8
	B	1	99	3	3	3	4	4	3	4	4	4	3	3.5	8.8
	C	2	98	4	4	5	4	4	3	3	3	3	5	3.8	9.5
	D	2	98	5	3	3	3	4	3	3	5	5	3	3.7	9.3
	E	2	98	3	4	5	3	3	3	5	5	4	5	4.0	10.0
32	A	0	100	-	-	-	-	-	-	-	-	-	-	-	-
	B	0	100	-	-	-	-	-	-	-	-	-	-	-	-
	C	0	100	-	-	-	-	-	-	-	-	-	-	-	-
	D	0	100	-	-	-	-	-	-	-	-	-	-	-	-
	E	0	100	-	-	-	-	-	-	-	-	-	-	-	-



Regina Thill
Crescent City Water Quality Control Laboratory
377 J Street
Crescent City, CA 95531

March 2, 2017

Tara:

I have enclosed our report “Chronic Toxicity Testing of City of Crescent City Wastewater Treatment Plant Effluent” for the effluent sample collected February 14, 2017. The results of this test are summarized below.

Chronic Effects of Crescent City Effluent on Giant Kelp (*Macrocystis pyrifera*)

There were ***no*** significant reductions in germination; the germination NOEC was 13.2% effluent, resulting in 7.6 TUc. There were significant reductions in growth; the growth NOEC was 6.6% effluent, resulting in 15.2 TUc.

If you have any questions regarding this testing, please feel free to call my colleague Dr. Brant Jorgenson or myself at (707) 207-7760.

Regards,

Michael McElroy
Project Manager



Pacific EcoRisk is accredited in accordance with NELAP (ORELAP ID 4043). Pacific EcoRisk certifies that the test results reported herein conform to the most current NELAP requirements for parameters for which accreditation is required and available. Any exceptions to NELAP requirements are noted, where applicable, in the body of the report. This report shall not be reproduced, except in full, without the written consent of Pacific EcoRisk. This testing was performed under Lab Order 26878.

Chronic Toxicity Testing of City of Crescent City Wastewater Treatment Plant Effluent

Sample collected February 14, 2017

Performed For

City of Crescent City
Water Quality Control Laboratory
377 J Street
Crescent City, CA 95531-4025

Prepared By

Pacific EcoRisk, Inc.
2250 Cordelia Road
Fairfield, CA 94534

March 2017



PACIFIC ECORISK
ENVIRONMENTAL CONSULTING & TESTING

Chronic Toxicity Testing of City of Crescent City Wastewater Treatment Plant Effluent

Sample collected February 14, 2017

Table of Contents

	Page
1. INTRODUCTION	1
2. TOXICITY TEST PROCEDURES	1
2.1 Receipt and Handling of the Effluent Sample	1
2.2 Algal Germination and Growth Toxicity Testing with <i>Macrocystis pyrifera</i>	1
2.2.1 Reference Toxicant Testing of the <i>Macrocystis pyrifera</i>	2
3. TESTING RESULTS.....	3
3.1 Chronic Effects of Crescent City Effluent on <i>Macrocystis pyrifera</i>	3
3.2 Reference Toxicant Toxicity to <i>Macrocystis pyrifera</i>	4
4. SUMMARY AND CONCLUSIONS	5
4.1 QA/QC Summary	5

Appendices

- Appendix A Chain-of-Custody Record for the Collection and Delivery of the Sample
- Appendix B Test Data and Summary of Statistics for the Evaluation of the Chronic Toxicity of Crescent City Effluent to the Giant Kelp, *Macrocystis pyrifera*
- Appendix C Test Data and Summary of Statistics for the Reference Toxicant Evaluation of the Giant Kelp, *Macrocystis pyrifera*



1. INTRODUCTION

The City of Crescent City has contracted Pacific EcoRisk (PER) to perform an evaluation of the chronic toxicity of Crescent City Wastewater Treatment Plant (Crescent City) effluent. The current evaluation consisted of performance of the chronic toxicity algal germination and growth test with giant kelp (*Macrocystis pyrifera*), using an effluent sample collected on February 14, 2017. In order to assess the sensitivity of the test organisms to toxic stress, a concurrent reference toxicant test was also performed. This report describes the performance and results of this testing.

2. TOXICITY TEST PROCEDURES

The methods used in this testing followed the guidelines established by the EPA manual “Short-Term Methods for Measuring the Chronic Toxicity of Effluents and Receiving Waters to West Coast Marine and Estuarine Organisms” (EPA/600/R-95/136).

2.1 Receipt and Handling of the Effluent Sample

On February 14, a sample of Crescent City effluent was collected into an appropriately cleaned sample container and shipped via overnight delivery, on ice and under chain-of-custody, to the PER laboratory in Fairfield, CA. Upon receipt at the laboratory, aliquots of the sample were collected for analysis of initial water quality characteristics (Table 1), with the remainder of the sample being stored at $\leq 6^{\circ}\text{C}$, except when being used to prepare test solutions. The chain-of-custody record for the collection and delivery of this sample is presented in Appendix A.

Date Sample Collected	Date Sample Received	Sample ID	Temp ($^{\circ}\text{C}$)	pH	D.O (mg/L)	Salinity (ppt)	Conductivity ($\mu\text{S}/\text{cm}$)	Total Ammonia (mg/L N)
2/14/17	2/15/17	Effluent Grab	0.0	6.96	7.6	0.2	356	3.1

2.2 Algal Germination and Growth Toxicity Testing with *Macrocystis pyrifera*

This chronic toxicity test with *M. pyrifera* consists of exposing kelp zoospores to the effluent for approximately 48 hours, after which the effects on zoospore germination and subsequent gametophyte growth (measured as gametophyte tube length) determined. The specific procedures used in this test are described below.

The Lab Water Control medium for this test consisted of filtered (1- μm) natural seawater (obtained from the U.C. Granite Canyon Marine Laboratory Carmel, CA). The effluent was adjusted to the test salinity of 34 ppt via addition of hypersaline brine (HSB). The Lab Water



Control medium and salinity-adjusted effluent were then used to prepare test solutions at test treatment concentrations of 0.8%, 1.6%, 3.3%, 6.6%, and 13.2% effluent. As an additional QA measure and in order to assess potential effects of the HSB addition on the effluent, a “Brine Control” consisting of filtered seawater diluted to the salinity of the effluent sample using Type 1 lab water, and then adjusted back up to the test salinity of 34 ppt via addition of the HSB, was also prepared and tested. Routine water quality characteristics (pH, D.O., and salinity) were measured for each test solution prior to use in this test.

Zoospores were obtained from kelp fronds (blades) of *M. pyrifera* collected from wild populations (David Guttoff, San Diego, CA). Approximately 25 fronds were cleaned of debris and epiphytic organisms by gently rubbing the blades while rinsing with 1- μ m filtered seawater, after which the blades were further desiccated by being exposed to air for approximately one hour. The desiccated kelp fronds were then rinsed with filtered seawater and placed into a 1-L glass beaker containing 1- μ m filtered seawater at 15°C in order to induce release of zoospores. After allowing zoospore release for approximately one hour, the kelp fronds were removed from the beakers, and the remaining solution was allowed to settle for 30 minutes, after which approximately 25% of the overlying water was decanted from the top of the solution into a separate clean beaker. Zoospore density was determined using a hemacytometer.

There were five replicates at each test treatment, each replicate consisting of a 450-mL polyethylene dish containing 200 mL of test solution. A glass microscope slide was placed into each replicate to provide a zoospore settling and germination substrate, after which the test was initiated by the addition of zoospores into each replicate to a final density of approximately 7,500 spores/mL. These replicate containers were randomly positioned within a temperature-controlled room at 15°C, under cool-white fluorescent lighting on a 16L:8D photoperiod.

After 48 (\pm 2) hours exposure, the contents of each test container were fixed via addition of glutaraldehyde. Each replicate slide was examined microscopically to determine the percent germination of the settled zoospores and the growth of the resulting gametophytes, as measured by germ tube length. The resulting germination and germ tube length data were analyzed to determine any impairment resulting from exposure to the effluent. All statistical analyses were performed using the CETIS[®] statistical software (TidePool Scientific, McKinleyville, CA).

2.2.1 Reference Toxicant Testing of the *Macrocystis pyrifera*

The reference toxicant test was performed similarly to the effluent test except that test solutions consisted of Lab Water Control medium spiked with copper chloride (CuCl₂) at concentrations of 5.6, 10, 18, 32, 56, 100, and 180 μ g/L (as Cu). The resulting test response data were analyzed to determine key dose-response point estimates. All statistical analyses were made using the CETIS software. These response endpoints were then compared to the typical response ranges established by the mean \pm 2 SD of the point estimates generated by the most recent previous reference toxicant tests performed by this lab.



3. TESTING RESULTS

3.1 Chronic Effects of Crescent City Effluent on *Macrocystis pyrifera*

The results of this test are summarized in Table 2. There were no significant reductions in germination; the germination NOEC was 13.2% effluent, resulting in 7.6 TUc. There were significant reductions in growth; the growth NOEC was 6.6% effluent, resulting in 15.2 TUc. Test data and summary of statistical analyses are presented in Appendix B.

Table 2. Chronic effects of Crescent City effluent on <i>Macrocystis pyrifera</i> .		
Effluent Treatment	Mean % Germination	Mean Germ Tube Length (μm)
Lab Water Control	91.2	13.4
Brine Control	91.4	12.9
0.8%	90.6	12.7
1.6%	91.4	12.5
3.3%	91.4	13.5
6.6%	88.2	12.5
13.2%	92.2	11.0*
Summary of Statistics		
NOEC =	13.2% effluent	6.6% effluent
TUc (100/NOEC) =	7.6	15.2
PMSD =	5.5%	11%

* The response at this test treatment was significantly less than the Lab Water Control treatment response ($p < 0.05$).



3.2 Reference Toxicant Toxicity to *Macrocystis pyrifera*

The results of this test are summarized in Table 3. The germination EC₅₀ and growth IC₅₀ for this test were consistent with the typical response ranges established by reference toxicant test database for this species, indicating that the test organisms were responding to toxic stress in a typical fashion. The test data and summary of statistical analyses for this test are presented in Appendix C.

Table 3. Reference toxicant testing: effects of Copper on <i>Macrocystis pyrifera</i> .		
Copper Concentration ($\mu\text{g/L}$ as Cu)	Mean % Germination	Mean Gametophyte Germ Tube Length (μm)
Lab Water Control	90.8	13.5
5.6	91.6	13.5
10	93.0	11.4*
18	90.8	10.5*
32	81.8*	8.4*
56	63.0*	7.9*
100	23.4*	7.7*
180	5.2*	7.6*
Summary of Statistics		
Germination EC ₅₀ or Growth IC ₂₅ =	70.6 $\mu\text{g/L}$ Cu	20.4 $\mu\text{g/L}$ Cu ^a

* The response at this test treatment was significantly less than the Lab Water Control treatment response ($p < 0.05$).

a - Due to a lack of a significant reduction in growth, the IC₅₀ could not be calculated. The IC₂₅ is reported in its place.



4. SUMMARY AND CONCLUSIONS

An evaluation of the chronic toxicity of Crescent City effluent was performed using an effluent sample collected February 14, 2017. The results of this test are summarized below.

Chronic Effects of Crescent City Effluent on Giant Kelp (*Macrocystis pyrifera*)

There were no significant reductions in germination; the germination NOEC was 13.2% effluent, resulting in 7.6 TUc. There were significant reductions in growth; the growth NOEC was 6.6% effluent, resulting in 15.2 TUc.

4.1 QA/QC Summary

Test Conditions – Test conditions (pH, D.O., temperature, etc.) were within acceptable limits. All analyses were performed according to laboratory Standard Operating Procedures.

Negative Control – The biological responses at the Lab Control treatments were within acceptable limits.

Positive Control – The results of the reference toxicant test were consistent with the typical response ranges established by the reference toxicant test database for this species, indicating that these test organisms were responding to toxicant stress in a typical and consistent fashion.

Concentration Response Relationships – The concentration-response relationships for these tests were evaluated per EPA guidelines (EPA-821-B-00-004) and were determined to be acceptable.



Appendix A

**Chain-of-Custody Record for the Collection and Delivery
of the Sample**



Pacific EcoRisk
 2250 Cordelia Rd., Fairfield, CA 94534
 (707) 207-7760 FAX (707) 207-7916

CHAIN-OF-CUSTODY RECORD

Results To: Crescent City Water Quality Control Lab		Invoice To: Same		REQUESTED ANALYSIS												
Address: 377 J Street Crescent City, CA 95531		Address:		Chronic <i>Macrocystis pyrifera</i> , EPA 1009.0												
Phone: (707)-465-5258		Phone:														
Attn: Regina Thill		Attn:														
E-mail: rthill@crescentcity.org		E-mail: twood@crescentcity.org														
Project Name: Crescent City Bi-annual Toxicity Testing																
P.O.#/Ref:																
Client Sample ID	Sample Date	Sample Time	Sample Matrix*	Grab/Comp	Container		X									
					Number	Type										
1 Effluent Grabs	2/14/17	1305	EFF	Grab	1	1 gallon cubitainer	X									
2																
3																
4																
5																
6																
7																
8																
9																
10																
Samples collected by: Jesse Wood																
Comments/Special Instruction: Perform testing in accordance with NPDES permit. Perform concurrent reference toxicant test. $O_2 = 0.00$				RELINQUISHED BY:						RECEIVED BY:						
				Signature: <i>Jesse Wood</i>						Signature: <i>R</i>						
				Print: Jesse Wood						Print: Regina Thill						
				Organization: City of Crescent City						Organization: CCWQL						
				Date: 2-14-17 Time: 1305						Date: 2/14/17 Time:						
				RELINQUISHED BY:						RECEIVED BY:						
Signature:						Signature: <i>Trevor Fischer</i>										
Print:						Print: Trevor Fischer										
Organization:						Organization: PER										
Date:						Date: 2/15/17 Time: 1123										

*Example Matrix Codes: (EFF - Effluent) (FW = Freshwater); (SW = Saltwater); (WW = Wastewater); (STRMW = Stormwater); (SED = Sediment); or other

Appendix B

Test Data and Summary of Statistics for the Evaluation of the Chronic Toxicity of Crescent City Effluent to the Giant Kelp, *Macrocystis pyrifera*



CETIS Summary Report

Report Date: 28 Feb-17 09:00 (p 1 of 2)
 Test Code: 71404 | 12-7527-0036

Macrocystis Germination and Growth Test **Pacific EcoRisk**

Batch ID: 09-6368-7508	Test Type: Growth-Germination	Analyst: Mike McElroy
Start Date: 15 Feb-17 16:35	Protocol: EPA/600/R-95/136 (1995)	Diluent: Filtered Seawater
Ending Date: 17 Feb-17 16:30	Species: Macrocystis pyrifera	Brine: Hyper-Saline Brine
Duration: 48h	Source: Dave Guttoff	Age: NA

Sample ID: 02-1386-9582	Code: NPDES	Client: Crescent City
Sample Date: 14 Feb-17 13:05	Material: Effluent	Project: 26878
Receipt Date: 15 Feb-17 11:23	Source: Crescent City Harbor	
Sample Age: 27h (0 °C)	Station: Effluent Grab	

Single Comparison Summary

Analysis ID	Endpoint	Comparison Method	P-Value	Comparison Result
21-1481-5640	Germination Rate	Equal Variance t Two-Sample Test	0.4628	Lab Water Control passed germination rate
21-2887-7631	Mean Length	Equal Variance t Two-Sample Test	0.8198	Lab Water Control passed mean length

Multiple Comparison Summary

Analysis ID	Endpoint	Comparison Method	NOEL	LOEL	TOEL	TU	PMSD ✓
10-1358-7833	Germination Rate	Dunnett Multiple Comparison Test	13.2	> 13.2	n/a	7.576	5.51%
08-8080-6603	Mean Length	Dunnett Multiple Comparison Test	6.6	13.2	9.334	15.15	10.6%

Point Estimate Summary

Analysis ID	Endpoint	Point Estimate Method	Level	%	95% LCL	95% UCL	TU	✓
18-8963-4273	Mean Length	Linear Interpolation (ICPIN)	IC5	7.54	1.77	11.9	13.27	
			IC10	10.4	4.22	n/a	9.606	
			IC15	>13.2	n/a	n/a	<7.576	
			IC20	>13.2	n/a	n/a	<7.576	
			IC25	>13.2	n/a	n/a	<7.576	
			IC40	>13.2	n/a	n/a	<7.576	
			IC50	>13.2	n/a	n/a	<7.576	

Germination Rate Summary

Conc-%	Code	Count	Mean	95% LCL	95% UCL	Min	Max	Std Err	Std Dev	CV%	%Effect
0	LW	5	0.912	0.880	0.944	0.880	0.940	0.012	0.026	2.84%	0.00%
0	B	5	0.914	0.891	0.937	0.890	0.940	0.008	0.018	1.99%	-0.22%
0.8		5	0.906	0.887	0.925	0.890	0.920	0.007	0.015	1.67%	0.66%
1.6		5	0.914	0.873	0.955	0.870	0.960	0.015	0.033	3.60%	-0.22%
3.3		5	0.914	0.861	0.967	0.840	0.950	0.019	0.043	4.68%	-0.22%
6.6		5	0.882	0.814	0.950	0.790	0.930	0.024	0.055	6.18%	3.29%
13.2		5	0.922	0.898	0.946	0.890	0.940	0.009	0.019	2.09%	-1.10%

Mean Length Summary

Conc-%	Code	Count	Mean	95% LCL	95% UCL	Min	Max	Std Err	Std Dev	CV%	%Effect
0	LW	5	13.4	12.3	14.5	12.8	15	0.403	0.901	6.71%	0.00%
0	B	5	12.9	11.8	13.9	11.5	13.8	0.384	0.858	6.67%	4.02%
0.8		5	12.7	11.9	13.5	11.8	13.3	0.292	0.652	5.13%	5.37%
1.6		5	12.5	12	13.1	11.8	13	0.203	0.455	3.63%	6.71%
3.3		5	13.5	12.7	14.3	12.5	14.3	0.297	0.665	4.93%	-0.45%
6.6		5	12.5	11	13.9	11.5	14.3	0.535	1.2	9.61%	7.15%
13.2		5	11	9.32	12.6	9.5	12.5	0.599	1.34	12.19%	18.18%

CETIS Summary Report

Report Date: 23 Feb-17 10:08 (p 2 of 2)
 Test Code: 71404 | 12-7527-0036

Macrocystis Germination and Growth Test							Pacific EcoRisk
Germination Rate Detail							
Conc-%	Code	Rep 1	Rep 2	Rep 3	Rep 4	Rep 5	
0	LW	0.920	0.890	0.880	0.930	0.940	
0	B	0.940	0.920	0.910	0.890	0.910	
0.8		0.920	0.890	0.920	0.910	0.890	
1.6		0.900	0.920	0.920	0.960	0.870	
3.3		0.930	0.840	0.950	0.920	0.930	
6.6		0.900	0.930	0.910	0.790	0.880	
13.2		0.920	0.940	0.930	0.890	0.930	
Mean Length Detail							
Conc-%	Code	Rep 1	Rep 2	Rep 3	Rep 4	Rep 5	
0	LW	15	13	13.3	13	12.8	
0	B	13	13.8	13.3	12.8	11.5	
0.8		12.3	11.8	12.8	13.3	13.3	
1.6		12.5	12.8	11.8	13	12.5	
3.3		13.8	14.3	13.5	13.3	12.5	
6.6		14.3	11.5	13	11.5	12	
13.2		12.5	9.5	10.3	10.3	12.3	
Germination Rate Binomials							
Conc-%	Code	Rep 1	Rep 2	Rep 3	Rep 4	Rep 5	
0	LW	92/100	89/100	88/100	93/100	94/100	
0	B	94/100	92/100	91/100	89/100	91/100	
0.8		92/100	89/100	92/100	91/100	89/100	
1.6		90/100	92/100	92/100	96/100	87/100	
3.3		93/100	84/100	95/100	92/100	93/100	
6.6		90/100	93/100	91/100	79/100	88/100	
13.2		92/100	94/100	93/100	89/100	93/100	

CETIS Analytical Report

Report Date: 23 Feb-17 10:08 (p 1 of 5)
 Test Code: 71404 | 12-7527-0036

Macrocystis Germination and Growth Test										Pacific EcoRisk	
Analysis ID: 10-1358-7833		Endpoint: Germination Rate			CETIS Version: CETISv1.9.2						
Analyzed: 23 Feb-17 10:05		Analysis: Parametric-Control vs Treatments			Official Results: Yes						
Data Transform		Alt Hyp			NOEL	LOEL	TOEL	TU	PMSD		
Angular (Corrected)		C > T			13.2	> 13.2	n/a	7.576	5.51%		
Dunnnett Multiple Comparison Test											
Control	vs	Conc-%	Test Stat	Critical	MSD	DF	P-Type	P-Value	Decision(α:5%)		
Brine Control		0.8	0.419	2.36	0.082	8	CDF	0.6816	Non-Significant Effect		
		1.6	-0.0934	2.36	0.082	8	CDF	0.8594	Non-Significant Effect		
		3.3	-0.129	2.36	0.082	8	CDF	0.8686	Non-Significant Effect		
		6.6	1.4	2.36	0.082	8	CDF	0.2588	Non-Significant Effect		
		13.2	-0.426	2.36	0.082	8	CDF	0.9291	Non-Significant Effect		
ANOVA Table											
Source	Sum Squares		Mean Square		DF	F Stat	P-Value	Decision(α:5%)			
Between	0.0126743		0.0025349		5	0.843	0.5325	Non-Significant Effect			
Error	0.0721458		0.0030061		24						
Total	0.0848201				29						
Distributional Tests											
Attribute	Test			Test Stat	Critical	P-Value	Decision(α:1%)				
Variances	Bartlett Equality of Variance Test			7.16	15.1	0.2087	Equal Variances				
Distribution	Shapiro-Wilk W Normality Test			0.935	0.903	0.0663	Normal Distribution				
Germination Rate Summary											
Conc-%	Code	Count	Mean	95% LCL	95% UCL	Median	Min	Max	Std Err	CV%	%Effect
0	B	5	0.914	0.891	0.937	0.910	0.890	0.940	0.008	1.99%	0.00%
0.8		5	0.906	0.887	0.925	0.910	0.890	0.920	0.007	1.67%	0.88%
1.6		5	0.914	0.873	0.955	0.920	0.870	0.960	0.015	3.60%	0.00%
3.3		5	0.914	0.861	0.967	0.930	0.840	0.950	0.019	4.68%	0.00%
6.6		5	0.882	0.814	0.950	0.900	0.790	0.930	0.024	6.18%	3.50%
13.2		5	0.922	0.898	0.946	0.930	0.890	0.940	0.009	2.09%	-0.88%
Angular (Corrected) Transformed Summary											
Conc-%	Code	Count	Mean	95% LCL	95% UCL	Median	Min	Max	Std Err	CV%	%Effect
0	B	5	1.27	1.23	1.32	1.27	1.23	1.32	0.0148	2.59%	0.00%
0.8		5	1.26	1.23	1.29	1.27	1.23	1.28	0.0116	2.05%	1.14%
1.6		5	1.28	1.2	1.35	1.28	1.2	1.37	0.0274	4.80%	-0.25%
3.3		5	1.28	1.19	1.37	1.3	1.16	1.35	0.0315	5.52%	-0.35%
6.6		5	1.23	1.13	1.32	1.25	1.09	1.3	0.0356	6.50%	3.80%
13.2		5	1.29	1.25	1.33	1.3	1.23	1.32	0.0154	2.68%	-1.16%

CETIS Analytical Report

Report Date: 23 Feb-17 10:08 (p 4 of 5)
 Test Code: 71404 | 12-7527-0036

Macrocystis Germination and Growth Test										Pacific EcoRisk	
Analysis ID: 08-8080-6603		Endpoint: Mean Length			CETIS Version: CETISv1.9.2						
Analyzed: 23 Feb-17 10:06		Analysis: Parametric-Control vs Treatments			Official Results: Yes						
Data Transform	Alt Hyp	NOEL	LOEL	TOEL	TU	PMSD					
Untransformed	C > T	6.6	13.2	9.334	15.15	10.62%					
Dunnnett Multiple Comparison Test											
Control	vs	Conc-%	Test Stat	Critical	MSD	DF	P-Type	P-Value	Decision(α:5%)		
Brine Control		0.8	0.311	2.36	1.37	8	CDF	0.7258	Non-Significant Effect		
		1.6	0.621	2.36	1.37	8	CDF	0.5929	Non-Significant Effect		
		3.3	-1.04	2.36	1.37	8	CDF	0.9849	Non-Significant Effect		
		6.6	0.725	2.36	1.37	8	CDF	0.5456	Non-Significant Effect		
		13.2*	3.28	2.36	1.37	8	CDF	0.0067	Significant Effect		
ANOVA Table											
Source	Sum Squares		Mean Square	DF	F Stat	P-Value	Decision(α:5%)				
Between	17.2857		3.45713	5	4.12	0.0077	Significant Effect				
Error	20.144		0.839333	24							
Total	37.4297			29							
Distributional Tests											
Attribute	Test			Test Stat	Critical	P-Value	Decision(α:1%)				
Variances	Bartlett Equality of Variance Test			5.68	15.1	0.3385	Equal Variances				
Distribution	Shapiro-Wilk W Normality Test			0.98	0.903	0.8183	Normal Distribution				
Mean Length Summary											
Conc-%	Code	Count	Mean	95% LCL	95% UCL	Median	Min	Max	Std Err	CV%	%Effect
0	B	5	12.9	11.8	13.9	13	11.5	13.8	0.384	6.67%	0.00%
0.8		5	12.7	11.9	13.5	12.8	11.8	13.3	0.292	5.13%	1.40%
1.6		5	12.5	12	13.1	12.5	11.8	13	0.203	3.63%	2.80%
3.3		5	13.5	12.7	14.3	13.5	12.5	14.3	0.297	4.93%	-4.66%
6.6		5	12.5	11	13.9	12	11.5	14.3	0.535	9.61%	3.26%
13.2		5	11	9.32	12.6	10.3	9.5	12.5	0.599	12.19%	14.75%

CETIS Analytical Report

Report Date: 23 Feb-17 10:08 (p 3 of 5)
 Test Code: 71404 | 12-7527-0036

Macrocystis Germination and Growth Test										Pacific EcoRisk	
Analysis ID: 21-1481-5640		Endpoint: Germination Rate			CETIS Version: CETISv1.9.2						
Analyzed: 23 Feb-17 10:06		Analysis: Parametric-Two Sample			Official Results: Yes						
Data Transform		Alt Hyp			Comparison Result					PMSD	
Angular (Corrected)		C > T			Lab Water Control passed germination rate					2.97%	
Equal Variance t Two-Sample Test											
Control	vs	Control II	Test Stat	Critical	MSD	DF	P-Type	P-Value	Decision(α:5%)		
Brine Control		Lab Water Contr	0.0963	1.86	0.047	8	CDF	0.4628	Non-Significant Effect		
ANOVA Table											
Source	Sum Squares		Mean Square	DF	F Stat	P-Value	Decision(α:5%)				
Between	1.469E-05		1.469E-05	1	0.00928	0.9256	Non-Significant Effect				
Error	0.0126647		0.0015831	8							
Total	0.0126793			9							
Distributional Tests											
Attribute	Test			Test Stat	Critical	P-Value	Decision(α:1%)				
Variances	Variance Ratio F Test			1.9	23.2	0.5481	Equal Variances				
Distribution	Shapiro-Wilk W Normality Test			0.939	0.741	0.5443	Normal Distribution				
Germination Rate Summary											
Conc-%	Code	Count	Mean	95% LCL	95% UCL	Median	Min	Max	Std Err	CV%	%Effect
0	LW	5	0.912	0.880	0.944	0.920	0.880	0.940	0.012	2.84%	0.00%
0	B	5	0.914	0.891	0.937	0.910	0.890	0.940	0.008	1.99%	-0.22%
Angular (Corrected) Transformed Summary											
Conc-%	Code	Count	Mean	95% LCL	95% UCL	Median	Min	Max	Std Err	CV%	%Effect
0	LW	5	1.27	1.22	1.33	1.28	1.22	1.32	0.0204	3.58%	0.00%
0	B	5	1.27	1.23	1.32	1.27	1.23	1.32	0.0148	2.59%	-0.19%

CETIS Analytical Report

Report Date: 23 Feb-17 10:08 (p 5 of 5)
 Test Code: 71404 | 12-7527-0036

Macrocystis Germination and Growth Test										Pacific EcoRisk	
Analysis ID: 21-2887-7631		Endpoint: Mean Length			CETIS Version: CETISv1.9.2						
Analyzed: 23 Feb-17 10:06		Analysis: Parametric-Two Sample			Official Results: Yes						
Data Transform		Alt Hyp			Comparison Result					PMSD	
Untransformed		C > T			Lab Water Control passed mean length					8.04%	
Equal Variance t Two-Sample Test											
Control	vs	Control II	Test Stat	Critical	MSD	DF	P-Type	P-Value	Decision(α:5%)		
Brine Control		Lab Water Contr	-0.97	1.86	1.04	8	CDF	0.8198	Non-Significant Effect		
ANOVA Table											
Source	Sum Squares		Mean Square		DF	F Stat	P-Value	Decision(α:5%)			
Between	0.729		0.729		1	0.941	0.3604	Non-Significant Effect			
Error	6.196		0.7745		8						
Total	6.925				9						
Distributional Tests											
Attribute	Test			Test Stat	Critical	P-Value	Decision(α:1%)				
Variances	Variance Ratio F Test			1.1	23.2	0.9274	Equal Variances				
Distribution	Shapiro-Wilk W Normality Test			0.971	0.741	0.8996	Normal Distribution				
Mean Length Summary											
Conc-%	Code	Count	Mean	95% LCL	95% UCL	Median	Min	Max	Std Err	CV%	%Effect
0	LW	5	13.4	12.3	14.5	13	12.8	15	0.403	6.71%	0.00%
0	B	5	12.9	11.8	13.9	13	11.5	13.8	0.384	6.67%	4.02%

Kelp (*M. pyrifera*) Development Toxicity Test Data

Client: Crescent City Test Start Date: 2/15/17 Test End Date: 2/17/17 Enumeration Date: 2/22/17
 Test Material: Effluent Test ID #: 71404 Project #: 26878 Investigator: JV
 Control Medium: 0.2 µm filtered SW Sample salinity adjusted with: Hyper Saline Brine Micrometer Conv. Factor: 2.5

KCl (g/L)	Rep	Germination		Length Measurements (in ocular micrometer units)										MEAN	Corrected Mean Length (µm)
		# Spores Germinated	# Spores not Germinated	L1	L2	L3	L4	L5	L6	L7	L8	L9	L10		
Lab Control	A	92	8	4	9	6	6	6	7	6	6	4	6	6.0	15.0
	B	89	11	7	4	5	4	6	4	5	4	5	8	5.2	13.0
	C	88	12	4	6	6	6	5	5	6	5	4	6	5.3	13.3
	D	93	7	6	5	4	5	5	6	4	5	6	6	5.2	13.0
	E	94	6	4	5	4	5	6	7	5	4	6	5	5.1	12.8
0.8%	A	92	8	5	4	6	5	6	5	4	5	5	4	4.9	12.3
	B	89	11	6	5	3	3	5	5	5	4	6	5	4.7	11.8
	C	92	8	4	5	4	6	6	6	6	5	4	5	5.1	12.8
	D	91	9	4	5	5	6	6	7	5	6	4	5	5.3	13.3
	E	89	11	5	6	5	6	6	5	6	4	5	5	5.3	13.3
1.6%	A	90	10	6	5	6	5	5	6	3	6	4	4	5.0	12.5
	B	92	8	6	3	5	5	6	6	5	5	4	6	5.1	12.8
	C	92	8	5	5	4	5	5	5	5	4	4	5	4.7	11.8
	D	96	4	6	6	4	5	6	5	8	3	5	4	5.2	13.0
	E	87	13	5	5	4	6	5	5	7	4	4	5	5.0	12.5
3.3%	A	93	7	6	5	5	6	5	6	7	4	6	5	5.5	13.8
	B	84	16	6	6	5	4	6	7	7	5	5	6	5.7	14.3
	C	95	5	8	7	3	4	4	6	4	6	6	6	5.4	13.5
	D	92	8	4	6	5	5	6	5	6	6	4	6	5.3	13.3
	E	93	7	5	5	6	4	4	5	5	5	5	6	5.0	12.5
6.6%	A	90	10	5	6	7	5	4	7	6	7	4	6	5.7	14.3
	B	93	7	5	4	5	5	6	5	3	4	3	6	4.6	11.5
	C	91	9	5	5	4	6	6	5	8	5	3	5	5.2	13.0
	D	79	21	4	5	6	4	4	5	3	6	5	4	4.6	11.5
	E	88	12	5	5	5	6	4	3	5	5	6	4	4.8	12.0
13.2%	A	92	8	5	7	4	6	7	3	3	4	6	5	5.0	12.5
	B	94	6	3	4	3	5	3	6	4	3	4	3	3.8	9.5
	C	93	7	4	3	4	5	5	3	3	3	5	6	4.1	10.3
	D	89	11	4	3	5	3	3	3	6	5	4	5	4.1	10.3
	E	93	7	4	5	4	3	6	5	7	4	7	4	4.9	12.3

Kelp (*M. pyrifera*) Development Toxicity Test Water Chemistry Data

Client: Crescent City
 Test Material: Effluent
 Test ID#: 71404 Project #: 26878
 Test Date: 2/15/17 Randomization: 6.5.1
 Sample Salinity adjusted with: Hyper Saline Brine

Organism Log#: 10089 Age: N/A
 Organism Supplier: David Cutoff
 Control/Diluent: 0.2 µm Filtered Seawater
 Light Intensity: 241.47

Day 0					
Treatment	Temperature (°C)	pH	D.O. (mg/L)	Salinity (ppt)	Signoff
Lab Control	14.6	7.76	8.6	320	Sample ID: <u>45437</u>
0.8%	14.6	7.75	8.7	320	Test Solution Prep: <u>SVV</u>
1.6%	14.6	7.74	8.8	320	New WQ: <u>YJ</u>
3.3%	14.6	7.74	8.6	320	Innoculation Date: <u>2/15/17</u>
6.6%	14.6	7.72	8.6	320	Innoculation Time: <u>1635</u>
13.2%	14.6	7.70	8.6	32.1	Innoculation Signoff: <u>Jo</u>
Meter ID	32A	PH19	R010	ECO4	

Day 1					
Treatment	Temperature (°C)	pH	D.O. (mg/L)	Salinity (ppt)	Signoff
Lab Control	14.7				Date: <u>2/16/17</u>
0.8%	14.7				Old WQ: <u>ED</u>
1.6%	14.7				
3.3%	14.7				
6.6%	14.7				
13.2%	14.7				
Meter ID	32A				

Day 2					
Treatment	Temperature (°C)	pH	D.O. (mg/L)	Salinity (ppt)	Signoff
Lab Control	14.7	7.75	7.2	330	Termination Time: <u>1630</u>
0.8%	14.7	7.75	7.2	32.3	Termination Signoff: <u>Jo</u>
1.6%	14.7	7.78	7.3	33.0	Old WQ: <u>Jan</u>
3.3%	14.7	7.78	7.3	32.9	
6.6%	14.7	7.78	7.3	33.2	
13.2%	14.7	7.79	7.3	33.3	
Meter ID	32A	PH21	R011	ECO4	

Kelp (*M. pyrifera*) Development Toxicity Test Data

Client: Crescent City Test Start Date: 2/15/17 Test End Date: 2/17/17 Enumeration Date: 2/22/17
 Test Material: Effluent Test ID #: 71404 Project #: 26878 Investigator: JL
 Control Medium: Filtered Seawater Sample salinity adjusted with: Hyper-Saline Brine Micrometer Conv. Factor: 2.5

		Germination		Length Measurements (in ocular micrometer units)											
Treatment	Rep	# Spores Germinated	# Spores not Germinated	L1	L2	L3	L4	L5	L6	L7	L8	L9	L10	MEAN	Corrected Mean Length (µm)
Lab Water Control	A	92	8	4	9	6	6	6	7	6	6	4	6	6.0	15.0
	B	89	11	7	4	8	4	6	4	5	4	5	8	5.2	13.0
	C	88	12	4	6	6	6	5	5	6	5	4	6	5.3	13.3
	D	93	7	6	5	4	5	5	6	4	5	6	6	5.2	13.0
	E	94	6	4	5	4	5	6	7	5	4	6	5	5.1	12.8
Brine Control	A	94	6	7	4	4	5	6	6	4	5	5	6	5.2	13.0
	B	92	8	6	4	4	6	5	5	6	6	5	8	5.5	13.8
	C	91	9	5	4	5	5	6	6	6	6	5	5	5.3	13.3
	D	89	11	5	4	5	5	7	5	5	6	4	5	5.1	12.8
	E	91	9	4	6	4	4	4	4	5	4	6	5	4.6	11.5

Kelp (*M. pyrifera*) Development Toxicity Test Water Chemistry Data

Client: Crescent City
 Test Material: Control Waters
 Test ID#: 71404 Project #: 26878
 Test Date: 2/15/17

Organism Log#: 10089 Age: N/A
 Organism Supplier: David Guttoff
 Control/Diluent: Filtered Seawater

Sample Salinity adjusted with : HSB

Day 0					
Treatment	Temperature (°C)	pH	D.O. (mg/L)	Salinity (ppt)	Signoff
Lab Water Control	14.6	7.76	8.6	32.0	Date & Inoculation Time: 2/15/17 1625
Brine Control	14.6	7.79	8.8	32.1	Solution Prep/Inoculation: SVV/ JO
Meter ID	32A	PH19	RD10	EC04	New WQ: YJ

Day 1					
Treatment	Temperature (°C)	pH	D.O. (mg/L)	Salinity (ppt)	Signoff
Lab Water Control	14.7				Date: 2/16/17
Brine Control	14.7				Old WQ: CO
Meter ID	32A				

Day 2					
Treatment	Temperature (°C)	pH	D.O. (mg/L)	Salinity (ppt)	Signoff
Lab Water Control	14.7	7.75	7.2	33.0	Date: 2/17/17
Brine Control	14.7	7.77	7.3	33.2	Termination: JO
Meter ID	32A	PH21	RD11	EC04	Old WQ: JAW

Appendix C

Test Data and Summary of Statistics for the Reference Toxicant Evaluation of the Giant Kelp, *Macrocystis pyrifera*

CETIS Summary Report

Report Date: 27 Feb-17 16:15 (p 1 of 2)
 Test Code: 71405 | 11-9574-3901

Macrocystis Germination and Growth Test				Pacific EcoRisk
Batch ID: 03-2964-9741	Test Type: Growth-Germination	Analyst: Scott Ford		
Start Date: 15 Feb-17 16:00	Protocol: EPA/600/R-95/136 (1995)	Diluent: Filtered Seawater		
Ending Date: 17 Feb-17 16:05	Species: Macrocystis pyrifera	Brine: Not Applicable		
Duration: 48h	Source: David Gutoff	Age: N/A		
Sample ID: 15-4432-0865	Code: CUCI2	Client: Reference Toxicant		
Sample Date: 15 Feb-17 16:00	Material: Copper chloride	Project: 26900		
Receipt Date: 15 Feb-17 16:00	Source: Reference Toxicant			
Sample Age: n/a (14.6 °C)	Station: In House			

Multiple Comparison Summary							
Analysis ID	Endpoint	Comparison Method	NOEL	LOEL	TOEL	TU	PMSD ✓
13-6007-5831	Germination Rate	Steel Many-One Rank Sum Test	18	32	24		5.55%
00-9956-2945	Mean Length	Steel Many-One Rank Sum Test	5.6	10	7.483		6.82%

Point Estimate Summary							
Analysis ID	Endpoint	Point Estimate Method	Level	µg/L	95% LCL	95% UCL	TU ✓
05-9177-7581	Germination Rate	Regression: Log-Normal (Probit)	EC5	27.1	24	29.9	
			EC10	33.4	30.3	36.4	
			EC15	38.6	35.3	41.6	
			EC20	43.2	39.9	46.3	
			EC25	47.6	44.3	50.7	
			EC40	60.9	57.6	64.1	
14-4620-3223	Mean Length	Linear Interpolation (ICPIN)	IC5	7.03	5.2	8.46	
			IC10	8.46	6.64	11.6	
			IC15	9.88	7.4	16.1	
			IC20	15.3	6.17	21.1	
			IC25	20.4	13.2	23.9	
			IC40	45.4	24.7	64.1	
			IC50	>180	n/a	n/a	

Germination Rate Summary											
Conc-µg/L	Code	Count	Mean	95% LCL	95% UCL	Min	Max	Std Err	Std Dev	CV%	%Effect
0	LW	5	0.908	0.898	0.918	0.900	0.920	0.004	0.008	0.92%	0.00%
5.6		5	0.916	0.897	0.935	0.900	0.940	0.007	0.015	1.66%	-0.88%
10		5	0.930	0.912	0.948	0.920	0.950	0.006	0.014	1.52%	-2.42%
18		5	0.908	0.863	0.953	0.850	0.950	0.016	0.036	4.00%	0.00%
32		5	0.818	0.784	0.852	0.770	0.840	0.012	0.028	3.39%	9.91%
56		5	0.630	0.501	0.759	0.520	0.750	0.046	0.104	16.46%	30.62%
100		5	0.234	0.196	0.272	0.210	0.280	0.014	0.031	13.03%	74.23%
180		5	0.052	0.036	0.068	0.040	0.070	0.006	0.013	25.07%	94.27%

Mean Length Summary											
Conc-µg/L	Code	Count	Mean	95% LCL	95% UCL	Min	Max	Std Err	Std Dev	CV%	%Effect
0	LW	5	13.5	12.9	14	13	13.8	0.196	0.438	3.25%	0.00%
5.6		5	13.5	12.8	14.3	12.5	14	0.267	0.597	4.42%	-0.30%
10		5	11.4	9.91	12.9	9.5	12.5	0.545	1.22	10.68%	15.28%
18		5	10.5	9.65	11.3	9.5	11.3	0.297	0.665	6.34%	22.26%
32		5	8.38	7.88	8.88	8	8.8	0.18	0.402	4.80%	37.83%
56		5	7.88	7.51	8.25	7.5	8.3	0.132	0.295	3.74%	41.54%
100		5	7.72	7.45	7.99	7.5	8	0.097	0.217	2.81%	42.73%
180		5	7.6	7.32	7.88	7.5	8	0.1	0.224	2.94%	43.62%

CETIS Summary Report

Report Date: 27 Feb-17 16:15 (p 2 of 2)
 Test Code: 71405 | 11-9574-3901

Macrocystis Germination and Growth Test							Pacific EcoRisk
Germination Rate Detail							
Conc-µg/L	Code	Rep 1	Rep 2	Rep 3	Rep 4	Rep 5	
0	LW	0.920	0.910	0.900	0.910	0.900	
5.6		0.910	0.910	0.900	0.920	0.940	
10		0.920	0.920	0.940	0.920	0.950	
18		0.950	0.910	0.920	0.910	0.850	
32		0.770	0.840	0.830	0.830	0.820	
56		0.750	0.590	0.560	0.730	0.520	
100		0.280	0.210	0.220	0.210	0.250	
180		0.060	0.050	0.040	0.040	0.070	
Mean Length Detail							
Conc-µg/L	Code	Rep 1	Rep 2	Rep 3	Rep 4	Rep 5	
0	LW	13.8	13.8	13	13.8	13	
5.6		14	13.5	12.5	13.8	13.8	
10		11.8	9.5	11	12.5	12.3	
18		11.3	10.3	10.8	9.5	10.5	
32		8.3	8.8	8.8	8	8	
56		7.8	7.5	7.8	8.3	8	
100		7.5	7.5	7.8	7.8	8	
180		7.5	7.5	7.5	8	7.5	
Germination Rate Binomials							
Conc-µg/L	Code	Rep 1	Rep 2	Rep 3	Rep 4	Rep 5	
0	LW	92/100	91/100	90/100	91/100	90/100	
5.6		91/100	91/100	90/100	92/100	94/100	
10		92/100	92/100	94/100	92/100	95/100	
18		95/100	91/100	92/100	91/100	85/100	
32		77/100	84/100	83/100	83/100	82/100	
56		75/100	59/100	56/100	73/100	52/100	
100		28/100	21/100	22/100	21/100	25/100	
180		6/100	5/100	4/100	4/100	7/100	

Macrocystis Germination and Growth Test

Pacific EcoRisk

Test Type: Growth-Germination
 Protocol: EPA/600/R-95/136 (1995)

Organism: Macrocystis pyrifera (Giant Kelp)
 Endpoint: Germination Rate

Material: Copper chloride
 Source: Reference Toxicant-REF

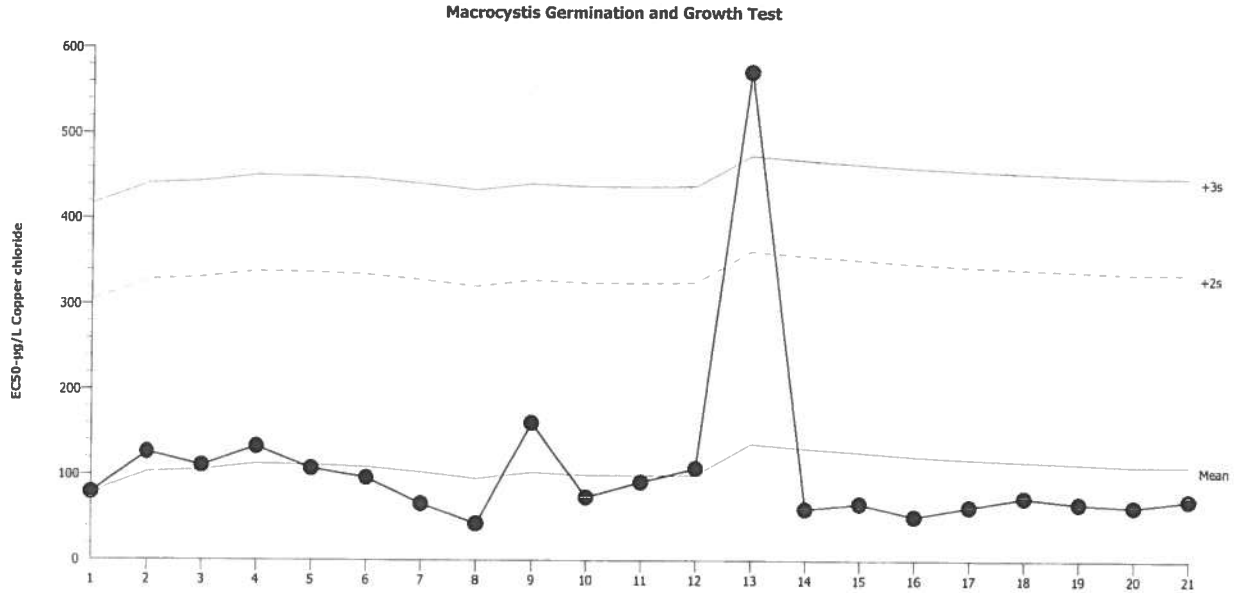

Mean: 110.5 Count: 20 -2s Warning Limit: -115.1 -3s Action Limit: -227.9
 Sigma: 112.8 CV: 102.00% +2s Warning Limit: 336.1 +3s Action Limit: 448.9

Quality Control Data

Point	Year	Month	Day	Time	QC Data	Delta	Sigma	Warning	Action	Test ID	Analysis ID
1	2008	Oct	16	14:30	79.02	-31.48	-0.2791			02-5635-3383	06-3217-1301
2		Nov	16	16:00	126.3	15.8	0.1401			13-6678-8116	18-5726-0200
3			19	15:30	110.6	0.067	0.000594			10-1292-9152	02-7285-1669
4	2009	Feb	11	14:40	132.9	22.42	0.1987			05-7166-1623	11-6404-0144
5			28	15:15	107.4	-3.146	-0.02789			12-1143-1603	12-9820-3193
6		Mar	14	18:35	96.37	-14.13	-0.1253			19-5641-8483	05-8506-0097
7			31	17:10	65.64	-44.86	-0.3977			17-0663-7956	04-7282-8436
8		Apr	11	14:20	42.64	-67.86	-0.6016			04-4563-2744	18-2165-7128
9			23	17:30	160.6	50.12	0.4443			17-7966-2450	06-9546-8884
10		May	6	16:10	73.75	-36.75	-0.3258			03-3186-2961	03-6247-5816
11	2013	Jan	30	14:45	91.4	-19.1	-0.1694			06-8508-3851	17-7991-3930
12		Feb	6	16:15	107.7	-2.815	-0.02496			11-3056-1267	03-3281-0263
13		Jul	24	15:10	572.1	461.6	4.092	(+)	(+)	13-4610-5540	07-9402-7487
14	2015	Nov	5	15:25	60.03	-50.47	-0.4474			17-6449-9142	08-5336-1355
15		Dec	29	15:30	66.44	-44.06	-0.3906			05-6611-4336	12-7788-9754
16	2016	Jan	14	15:25	51.34	-59.16	-0.5244			17-6824-0217	02-7384-9815
17		Feb	11	17:55	62.82	-47.68	-0.4227			09-8398-8624	10-8778-7063
18		May	11	17:01	73.46	-37.04	-0.3284			10-0416-5084	03-7997-2979
19		Oct	26	16:30	66.49	-44.01	-0.3902			13-5580-5678	11-9854-6523
20		Nov	30	16:00	62.96	-47.54	-0.4215			09-1674-9341	03-7124-9614
21	2017	Feb	15	16:00	70.55	-39.95	-0.3541			11-9574-3901	05-9177-7581

Macrocystis Germination and Growth Test

Pacific EcoRisk

Test Type: Growth-Germination
 Protocol: EPA/600/R-95/136 (1995)

Organism: Macrocystis pyrifera (Giant Kelp)
 Endpoint: Mean Length

Material: Copper chloride
 Source: Reference Toxicant-REF

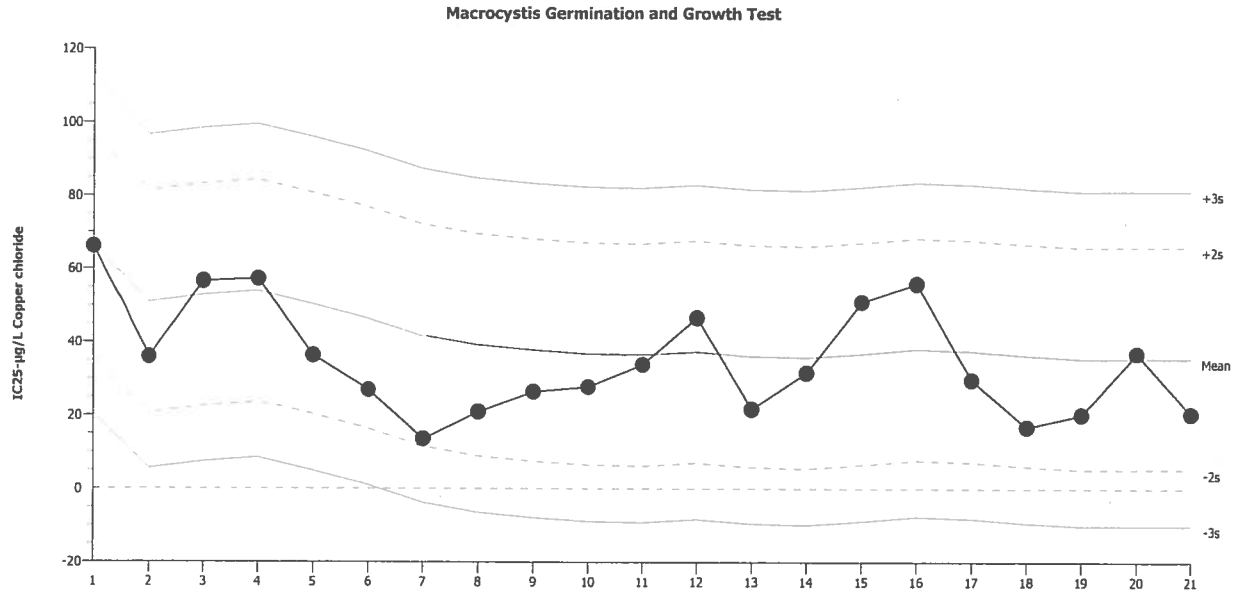

Mean: 35.62 Count: 20 -2s Warning Limit: 5.216 -3s Action Limit: -9.984
 Sigma: 15.2 CV: 42.70% +2s Warning Limit: 66.02 +3s Action Limit: 81.22

Quality Control Data

Point	Year	Month	Day	Time	QC Data	Delta	Sigma	Warning	Action	Test ID	Analysis ID
1	2008	Oct	16	14:30	66.15	30.53	2.008	(+)		02-5635-3383	08-0927-6399
2		Nov	16	16:00	35.95	0.3274	0.02154			13-6678-8116	09-9413-7824
3			19	15:30	56.63	21.01	1.382			10-1292-9152	11-2772-9114
4	2009	Feb	11	14:40	57.28	21.66	1.425			05-7166-1623	02-8196-9725
5			28	15:15	36.41	0.7874	0.05181			12-1143-1603	19-7989-7320
6		Mar	14	18:35	26.89	-8.73	-0.5743			19-5641-8483	02-6572-0942
7			31	17:10	13.55	-22.07	-1.452			17-0663-7956	19-9052-0522
8		Apr	11	14:20	20.91	-14.71	-0.9677			04-4563-2744	01-0372-1594
9			23	17:30	26.39	-9.227	-0.607			17-7966-2450	02-9784-1910
10		May	6	16:10	27.7	-7.921	-0.5211			03-3186-2961	09-7124-6571
11	2013	Jan	30	14:45	33.8	-1.82	-0.1197			06-8508-3851	17-0208-8428
12		Feb	6	16:15	46.73	11.11	0.7307			11-3056-1267	17-2307-7065
13		Jul	24	15:10	21.69	-13.93	-0.9162			13-4610-5540	00-8404-8807
14	2015	Nov	5	15:25	31.6	-4.019	-0.2644			17-6449-9142	19-8372-8712
15		Dec	29	15:30	51.07	15.45	1.017			05-6611-4336	09-4158-5062
16	2016	Jan	14	15:25	56	20.38	1.341			17-6824-0217	08-0278-3221
17		Feb	11	17:55	29.67	-5.953	-0.3917			09-8398-8624	05-0071-6836
18		May	11	17:01	16.81	-18.81	-1.237			10-0416-5084	10-8856-0736
19		Oct	26	16:30	20.17	-15.45	-1.017			13-5580-5678	09-9943-0268
20		Nov	30	16:00	36.92	1.3	0.08553			09-1674-9341	07-3581-9689
21	2017	Feb	15	16:00	20.37	-15.25	-1.004			11-9574-3901	14-4620-3223

Kelp (*M. pyrifera*) Development Toxicity Test DataClient: Reference Toxicant Test Start Date: 2/15/17 Test End Date: 2/17/17 Enumeration Date: 2/26/17Test Material: Copper (as CuCl2) Test ID #: 71405 Project #: 26900 Investigator: JLControl Medium: Filtered Seawater Micrometer Conv. Factor: 2.5

µg Cu/L	Rep	Germination		Length Measurements (in ocular micrometer units)										MEAN	Corrected Mean Length (µm)
		# Spores Germinated	# Spores not Germinated	L1	L2	L3	L4	L5	L6	L7	L8	L9	L10		
Control	A	92	8	6	7	5	6	6	7	4	6	3	5	5.5	138
	B	91	9	6	6	7	4	5	6	5	3	8	5	5.5	138
	C	90	10	4	7	7	4	7	4	3	6	4	6	5.2	130
	D	91	9	6	6	4	6	4	5	4	6	8	6	5.5	138
	E	90	10	4	6	6	6	5	5	6	4	6	4	5.2	130
5.6	A	91	9	6	5	6	5	4	7	5	7	6	5	5.6	140
	B	91	9	6	4	6	7	4	5	5	6	7	4	5.4	135
	C	90	10	6	3	4	4	5	6	5	6	6	5	5.0	12.5
	D	92	8	6	5	4	5	6	5	7	7	5	5	5.5	138
	E	94	6	4	5	5	6	6	6	5	6	8	4	5.5	138
10	A	92	8	3	6	5	5	4	4	5	6	5	4	4.7	11.8
	B	92	8	5	3	4	4	5	3	3	3	5	3	3.8	9.5
	C	94	6	5	3	4	4	5	6	5	4	4	4	4.4	11.0
	D	92	8	5	4	7	6	7	4	5	3	5	4	5.0	12.5
	E	95	5	6	7	4	5	4	5	3	5	6	4	4.9	12.3
18	A	95	5	5	5	6	4	5	3	5	4	3	5	4.5	11.3
	B	91	9	3	3	7	4	4	6	4	3	3	4	4.1	10.3
	C	92	8	5	3	5	4	5	3	5	5	5	3	4.3	10.9
	D	91	9	3	3	4	6	3	4	4	3	4	4	3.8	9.5
	E	85	15	3	3	5	4	4	3	5	6	6	3	4.2	10.5
32	A	77	23	3	4	4	3	3	3	3	3	4	3	3.3	8.3
	B	84	16	4	3	4	3	3	3	3	3	5	4	3.5	8.8
	C	83	17	3	6	3	3	3	4	4	3	3	3	3.5	8.8
	D	83	17	3	3	3	3	4	3	3	4	3	3	3.2	8.0
	E	82	18	3	3	3	3	4	3	4	3	3	3	3.2	8.0
56	A	75	25	3	3	3	4	3	3	3	3	3	3	3.1	7.8
	B	59	41	3	3	3	3	3	3	3	3	3	3	3.0	7.5
	C	56	44	3	3	3	4	3	3	3	3	3	3	3.1	7.8
	D	73	27	3	4	4	3	3	3	3	4	3	3	3.3	8.3
	E	52	48	3	4	3	3	3	3	3	3	3	4	3.2	8.0

Kelp (*M. pyrifera*) Development Toxicity Test Data

Client: Reference Toxicant Test Start Date: 2/15/17 Test End Date: 2/17/17 Enumeration Date: 2/26/17

Test Material: Copper chloride Test ID #: 71405 Project #: 26900 Investigator: JL

Control Medium: Filtered Seawater Micrometer Conv. Factor: 2.5

		Germination		Length Measurements (in ocular micrometer units)											
$\mu\text{g Cu/L}$	Rep	# Spores Germinated	# Spores not Germinated	L1	L2	L3	L4	L5	L6	L7	L8	L9	L10	MEAN	Corrected Mean Length (μm)
100	A	28	72	3	3	3	3	3	3	3	3	3	3	3.0	7.5
	B	21	79	3	3	3	3	3	3	3	3	3	3	3.0	7.5
	C	22	78	3	3	3	4	3	3	3	3	3	3	3.1	7.8
	D	21	79	3	3	3	3	3	4	3	3	3	3	3.1	7.8
	E	25	75	3	4	3	3	3	3	4	3	3	3	3.2	8.0
180	A	6	94	3	3	3	3	3	3	3	3	3	3	3.0	7.5
	B	5	95	3	3	3	3	3	3	3	3	3	3	3.0	7.5
	C	4	96	3	3	3	3	3	3	3	3	3	3	3.0	8.0 7.5
	D	4	96	3	3	3	5	3	3	3	3	3	3	3.2	8.0
	E	7	93	3	3	3	3	3	3	3	3	3	3	3.0	7.5

Kelp (*M. pyrifera*) Development Reference Toxicant Test Water Chemistry Data

Client: Reference Toxicant
 Test Material: Copper (as CuCl₂)
 Test ID#: 71405 Project #: 26900
 Test Date: 2/15/17 Randomization: 8.5.1

Organism Log#: 10089 Age: N/A
 Organism Supplier: David Gutoff
 Control/Diluent: Filtered Seawater
 Light Intensity: 239.4

Day 0					
Treatment ($\mu\text{g Cu/L}$)	Temperature ($^{\circ}\text{C}$)	pH	D.O. (mg/L)	Salinity (ppt)	Signoff
Control	14.6	7.72	9.2	32.0	Test Solution Prep: Jo
5.6	14.6	7.74	9.1	32.1	New WQ: Jan
10	14.6	7.75	8.9	32.0	Innoculation Date: 2/15/17
18	14.6	7.75	8.9	32.0	Innoculation Time: 16:00
32	14.6	7.76	8.1	32.5	Innoculation Signoff: Jo
56	14.6	7.68	8.1	32.4	
100	14.6	7.69	7.7	32.4	
180	14.6	7.68	8.0	32.2	
Meter ID	32A	PH19	RD10	EC04	

Day 1					
Treatment ($\mu\text{g Cu/L}$)	Temperature ($^{\circ}\text{C}$)	pH	D.O. (mg/L)	Salinity (ppt)	Signoff
Control	14.7				Date: 2/16/17
5.6	14.7				WQ Signoff: CO
10	14.7				
18	14.7				
32	14.7				
56	14.7				
100	14.7				
180	14.7				
Meter ID	32A				

Day 2					
Treatment ($\mu\text{g Cu/L}$)	Temperature ($^{\circ}\text{C}$)	pH	D.O. (mg/L)	Salinity (ppt)	Signoff
Control	14.7	7.78	7.2	32.0	Termination Date: 2/17/17
5.6	14.7	7.79	7.3	32.5	Termination Time: 16:05
10	14.7	7.79	7.3	32.7	Termination Signoff: Jo
18	14.7	7.79	7.3	32.8	Old WQ: Jan
32	14.7	7.78	7.4	32.8	
56	14.7	7.78	7.4	32.5	
100	14.7	7.78	7.4	32.7	
180	14.7	7.78	7.3	32.6	
Meter ID	32A	PH21	RD11	EC04	



Tara Wood
Crescent City Water Quality Control Laboratory
377 J Street
Crescent City, CA 95531

August 24, 2017

Tara:

I have enclosed our report “Chronic Toxicity Testing of Crescent City Wastewater Treatment Plant Effluent” for the effluent samples collected August 2, 4, and 7, 2017. The results of this test are summarized below.

Chronic Effects of Crescent City Effluent on Giant Kelp (*Macrocystis pyrifera*)

There was no reduction to germination and a 0.98% reduction in growth at the 3.45% effluent concentration; the TST analysis resulted in a pass for both endpoints.

Chronic Effects of Crescent City Effluent on *Mytilus galloprovincialis*

There was no reduction in normal development at the 3.45% effluent concentration; the TST analysis resulted in a pass.

Chronic Effects of Crescent City Effluent on *Atherinops affinis* (Topsmelt)

There was no reduction in survival and a 8.2% reduction in growth at the 3.45% effluent concentration; the TST analysis resulted in a pass for both endpoints.

If you have any questions regarding this testing, please feel free to call my colleague Dr. Brant Jorgenson or myself at (707) 207-7760.

Regards,

Michael McElroy
Project Manager



Pacific EcoRisk is accredited in accordance with NELAP (ORELAP ID 4043). Pacific EcoRisk certifies that the test results reported herein conform to the most current NELAP requirements for parameters for which accreditation is required and available. Any exceptions to NELAP requirements are noted, where applicable, in the body of the report. This report shall not be reproduced, except in full, without the written consent of Pacific EcoRisk. This testing was performed under Lab Order 27678.

Chronic Toxicity Testing of Crescent City Wastewater Treatment Plant Effluent

Sample collected August 2, 4, and 7, 2017

Performed For

City of Crescent City
Water Quality Control Laboratory
377 J Street
Crescent City, CA 95531-4025

Prepared By

Pacific EcoRisk, Inc.
2250 Cordelia Road
Fairfield, CA 94534

August 2017



Chronic Toxicity Testing of Crescent City Wastewater Treatment Plant Effluent

Sample collected August 2, 4, and 7, 2017

Table of Contents

	Page
1. INTRODUCTION	1
2. TOXICITY TEST PROCEDURES	1
2.1 Sample Receipt and Handling.....	1
2.2 Germination and Growth Toxicity Testing with <i>Macrocystis pyrifera</i>	1
2.2.1 Reference Toxicant Testing of the <i>Macrocystis pyrifera</i>	2
2.3 Embryo Development Toxicity Testing with <i>Mytilus galloprovincialis</i>	3
2.3.1 Reference Toxicant Testing of the <i>Mytilus galloprovincialis</i>	4
2.4 Survival and Growth Toxicity Testing with Topsmelt (<i>Atherinops affinis</i>)	4
2.4.1 Reference Toxicant Testing of the Topsmelt	5
3. TESTING RESULTS.....	6
3.1 Chronic Effects of Crescent City Effluent on <i>Macrocystis pyrifera</i>	6
3.1.1 Reference Toxicant Toxicity to <i>Macrocystis pyrifera</i>	6
3.2 Chronic Effects of Crescent City Effluent on <i>Mytilus galloprovincialis</i>	7
3.2.1 Reference Toxicant Toxicity to <i>Mytilus galloprovincialis</i>	7
3.3 Chronic Effects of Crescent City Effluent on Topsmelt.....	8
3.3.1 Reference Toxicant Toxicity to Topsmelt.....	8
4. SUMMARY AND CONCLUSIONS	9
4.1 QA/QC Summary	9



Appendices

- Appendix A Chain-of-Custody Record for the Collection and Delivery of the Sample
- Appendix B Test Data and Summary of Statistics for the Evaluation of the Chronic Toxicity of Crescent City Effluent to *Macrocystis pyrifera*
- Appendix C Test Data and Summary of Statistics for the Reference Toxicant Evaluation of the *Macrocystis pyrifera*
- Appendix D Test Data and Summary of Statistics for the Evaluation of the Chronic Toxicity of Crescent City Effluent to *Mytilus galloprovincialis*
- Appendix E Test Data and Summary of Statistics for the Reference Toxicant Evaluation of the *Mytilus galloprovincialis*
- Appendix F Test Data and Summary of Statistics for the Evaluation of the Chronic Toxicity of Crescent City Effluent to *Atherinops affinis*
- Appendix G Test Data and Summary of Statistics for the Reference Toxicant Evaluation of the *Atherinops affinis*



1. INTRODUCTION

The City of Crescent City has contracted Pacific EcoRisk (PER) to perform an evaluation of the chronic toxicity of Crescent City Wastewater Treatment Plant (Crescent City) effluent. This evaluation consisted of performing the following US EPA chronic toxicity tests:

- 48-hour chronic germination and growth test with giant kelp (*Macrocystis pyrifera*);
- 48-hour embryo-development test with blue mussel (*Mytilus galloprovincialis*); and
- 7-day survival and growth test with topsmelt (*Atherinops affinis*).

These tests were performed on samples of Crescent City effluent collected August 2, 4, and 7, 2017. In order to assess the sensitivity of the chronic toxicity test organisms to toxic stress, reference toxicant tests were also performed. This report describes the performance and results of these tests.

2. TOXICITY TEST PROCEDURES

The methods used in this testing followed the guidelines established by the EPA manual “Short-Term Methods for Measuring the Chronic Toxicity of Effluents and Receiving Waters to West Coast Marine and Estuarine Organisms” (EPA/600/R-95/136).

2.1 Sample Receipt and Handling

On August 2, 4, and 7, samples of Crescent City effluent were collected into appropriately cleaned sample containers and shipped via overnight delivery, on ice and under chain-of-custody, to the PER laboratory in Fairfield, CA. Upon receipt at the laboratory, aliquots of the samples were collected for analysis of initial water quality characteristics (Table 1), with the remainder of the samples being stored at $\leq 6^{\circ}\text{C}$, except when being used to prepare test solutions. The chain-of-custody record for the collection and delivery of this sample is presented in Appendix A.

Date Sample Collected	Date Sample Received	Sample ID	Temp (°C)	pH	D.O (mg/L)	Salinity (ppt)	Conductivity ($\mu\text{S}/\text{cm}$)	Total Ammonia (mg/L N)
8/2/17	8/3/17	Effluent Grab	0.8	7.30	8.4	0.3	551	7.21
8/4/17	8/5/17	Effluent Grab	1.0	7.28	7.9	0.3	664	10.7
8/7/17	8/8/17	Effluent Grab	1.3	7.08	6.8	0.3	568	12.1

2.2 Germination and Growth Toxicity Testing with *Macrocystis pyrifera*

This chronic toxicity test with *M. pyrifera* consists of exposing kelp zoospores to the effluent for approximately 48 hours, after which the effects on zoospore germination and subsequent



gametophyte growth (measured as gametophyte tube length) determined. The specific procedures used in this test are described below.

The Lab Water Control medium for this test consisted of filtered (1- μ m) natural seawater (obtained from the U.C. Granite Canyon Marine Laboratory Carmel, CA). The effluent was adjusted to the test salinity of 34 ppt via addition of hypersaline brine (HSB). The Lab Water Control medium and salinity-adjusted effluent were used to prepare test solutions at the test treatment concentration of 3.45% effluent. As an additional QA measure and in order to assess potential effects of the HSB addition on the effluent, a “Brine Control” consisting of filtered seawater diluted to the salinity of the effluent sample using Type 1 lab water, and then adjusted back up to the test salinity of 34 ppt via addition of the HSB, was also prepared and tested. Routine water quality characteristics (pH, D.O., and salinity) were measured for each test solution prior to use in this test.

Zoospores were obtained from kelp fronds (blades) of *M. pyrifera* collected from wild populations (Alexi Gabriel, San Diego, CA). Approximately 25 fronds were cleaned of debris and epiphytic organisms by gently rubbing the blades while rinsing with 1- μ m filtered seawater, after which the blades were further desiccated by being exposed to air for approximately one hour. The desiccated kelp fronds were then rinsed with filtered seawater and placed into a 1-L glass beaker containing 1- μ m filtered seawater at 15°C in order to induce release of zoospores. After allowing zoospore release for approximately one hour, the kelp fronds were removed from the beakers, and the remaining solution was allowed to settle for 30 minutes, after which approximately 25% of the overlying water was decanted from the top of the solution into a separate clean beaker. Zoospore density was determined using a hemacytometer.

There were five replicates at each test treatment, each replicate consisting of a 450-mL polyethylene dish containing 200 mL of test solution. A glass microscope slide was placed into each replicate to provide a zoospore settling and germination substrate, after which the test was initiated by the addition of zoospores into each replicate to a final density of approximately 7,500 spores/mL. These replicate containers were randomly positioned within a temperature-controlled room at 15°C, under cool-white fluorescent lighting on a 16L:8D photoperiod.

After 48 (\pm 2) hours exposure, the contents of each test container were fixed via addition of glutaraldehyde. Each replicate slide was examined microscopically to determine the percent germination of the settled zoospores and the growth of the resulting gametophytes, as measured by germ tube length. The resulting germination and germ tube length data were analyzed to determine any impairment resulting from exposure to the effluent. All statistical analyses were performed using the CETIS[®] statistical software (TidePool Scientific, McKinleyville, CA).

2.2.1 Reference Toxicant Testing of the *Macrocystis pyrifera*

The reference toxicant test was performed similarly to the effluent test except that test solutions consisted of Lab Water Control medium spiked with copper chloride (CuCl₂) at concentrations of 5.6, 10, 18, 32, 56, 100, 180, 324, and 583 μ g/L (as Cu). The resulting test response data were



analyzed to determine key dose-response point estimates. All statistical analyses were made using the CETIS software. These response endpoints were then compared to the typical response ranges established by the mean \pm 2 SD of the point estimates generated by the most recent previous reference toxicant tests performed by this lab.

2.3 Embryo Development Toxicity Testing with *Mytilus galloprovincialis*

The chronic toxicity test with *M. galloprovincialis* consists of exposing mussel embryos to the effluent for 48 hours, after which effects on embryo development are determined. The specific procedures used in this test are described below.

The Lab Water Control medium for this test consisted of 1- μ m filtered seawater (collected from the UC Granite Canyon Marine Laboratory) diluted to a salinity of 30 ppt with Type 1 lab water (reverse-osmosis, de-ionized water). The Lab Water Control medium and effluent sample were used to prepare test solutions at the test treatment concentration of 3.45% effluent. Routine water quality characteristics (pH, D.O., and salinity) were measured for each test solution prior to use in this test.

Bivalve embryos were generated from gravid adult *M. galloprovincialis*. Prior to spawning, the adult bivalves were held in seawater at a temperature of 12°C. To induce spawning, the adults were placed into glass trays of clean seawater at 20°C. This increase in temperature induced the bivalves to release sperm and eggs. When an individual was observed to begin releasing sperm or eggs, it was transferred to a separate container for isolation and collection of gametes, which were examined microscopically to evaluate viability and quality. The gametes exhibiting the best quality were used to prepare freshly fertilized embryos.

Each test replicate consisted of a 30-mL glass vial containing 10 mL of appropriate test solution. Additional replicates were also established to verify the inoculation density, and additional observation vials were established at the natural seawater Lab Control treatment for monitoring of successful embryo development. Finally, “water quality” vials (30-mL vials containing 20 mL of test solution at the same embryo density as the test vials) were established for each treatment in order to measure the final water quality characteristics.

The test was initiated with the random inoculation of approximately 150-300 embryos into each vial. These test, observation, and monitoring vials were then placed into a temperature-controlled incubator at 18°C under a 16L:8D photoperiod.

After 48 (\pm 1) hrs, the observation vials were examined to ensure that \geq 90% of the surviving embryos achieved normal development to the “D-hinge” stage. Upon confirming adequate successful embryo development, the test was terminated. The final water quality characteristics were determined from the water quality vial at each treatment, and the remaining test embryos were fixed by the addition of 1 mL of 5% glutaraldehyde to each replicate vial. The contents of each preserved test vial were subsequently examined microscopically to determine the



percentage of embryos exhibiting normal development. The resulting embryo development data were analyzed to evaluate any impairments due to the effluent. All statistical analyses were performed using the CETIS statistical software.

2.3.1 Reference Toxicant Testing of the *Mytilus galloprovincialis*

The reference toxicant test was performed similarly to the effluent toxicity test, except that test solutions consisted of Lab Water Control medium (30 ppt seawater) spiked with KCl at concentrations of 0.5, 1, 2, 3, and 4 g/L. The resulting test response data were analyzed to determine key dose-response point estimates. All statistical analyses were made using the CETIS software. These response endpoints were then compared to the typical response ranges established by the mean \pm 2 SD of the point estimates generated by the most recent previous reference toxicant tests performed by this lab.

2.4 Survival and Growth Toxicity Testing with Topsmelt (*Atherinops affinis*)

The short-term chronic topsmelt test consists of exposing larval fish to the effluent for 7 days, after which effects on survival and growth are evaluated. The specific procedures used in this testing are described below.

The larval topsmelt used in these tests were obtained from a commercial supplier (Aquatic Biosystems, Fort Collins, CO). Upon receipt at the testing lab, the larval fish were maintained in a tank containing aerated Lab Water Control medium. The fish were fed brine shrimp nauplii *ad libitum* during the pre-test holding period.

The Lab Water Control medium for these tests consisted of 0.2 μ m filtered seawater (U.C. Granite Canyon Marine Laboratory, CA). The Lab Water Control medium and effluent were used to prepare test solutions at the test treatment concentration of 3.45% effluent. Routine water quality characteristics (pH, D.O., and salinity) were measured for each test solution prior to use in these tests.

There were five replicates for each test treatment, each replicate consisting of 400 mL of test solution in a 600-mL glass beaker. The tests were initiated by randomly allocating five 13-day old topsmelt into each replicate beaker. The beakers were randomly positioned in a temperature-controlled room at 20°C, under a 16L:8D photoperiod. These test fish were fed brine shrimp nauplii twice daily.

Each day of the tests, fresh test solutions were prepared as before. The test replicate beakers were examined, with any dead animals, uneaten food, wastes, and other detritus being removed. The number of live fish in each replicate was determined and then approximately 80% of the test media in each beaker was carefully poured out and replaced with fresh media. “Old” water quality characteristics (pH and D.O.) were measured on the old test water collected from one randomly selected replicate at each treatment. The test beakers were then placed back into the temperature-controlled room.



After 7 days exposure, the tests were terminated and the number of live fish in each replicate beaker was recorded. The fish from each replicate were then carefully euthanized in methanol, rinsed in de-ionized water, and transferred to a pre-dried and pre-tared weighing pan. The fish were then dried at 100°C for ≥ 24 hours and re-weighed to determine the total weight of fish in each replicate; the total weight was then divided by the initial number of fish per replicate to determine the biomass value. The resulting survival and biomass value data were analyzed to determine any impairment(s) caused by the effluent. All statistical analyses were performed using the CETIS statistical software.

2.4.1 Reference Toxicant Testing of the Topsmelt

The reference toxicant test was performed similarly to the effluent tests, but used test solutions consisting of Lab Water Control media spiked with copper chloride concentrations of 56, 100, 180, 320, 560, and 1000 $\mu\text{g Cu/L}$. The resulting test response data were analyzed to determine key dose-response point estimates. All statistical analyses were made using the CETIS software. These response endpoints were then compared to the typical response ranges established by the mean ± 2 SD of the point estimates generated by the most recent previous reference toxicant tests performed by this lab.



3. TESTING RESULTS

3.1 Chronic Effects of Crescent City Effluent on *Macrocystis pyrifera*

The results of this test are summarized in Table 2. There was no reduction to germination and a 0.98% reduction in growth at the 3.45% effluent concentration; the TST analysis resulted in a pass for both endpoints. Test data and summary of statistical analyses are presented in Appendix B.

Effluent Treatment	Mean % Germination	Mean Germ Tube Length (μm)
Brine Control	0.67	12.3
Lab Water Control	0.73	12.2
3.45%	0.73	12.1
Summary of Statistics		
Percent (%) Effect =	no reduction	0.98%
TST Analysis =	Pass	Pass

3.1.1 Reference Toxicant Toxicity to *Macrocystis pyrifera*

The results of this test are summarized in Table 3. The kelp growth IC₅₀ was above the upper threshold of the typical response range established by the reference toxicant test database for this species, thus suggesting the kelp may have been slightly less sensitive than is typical. The germination EC₅₀ was consistent with the typical response range, indicating that the test organisms were responding to toxic stress in a typical and consistent fashion. The test data and summary of statistical analyses for this test are presented in Appendix C.

Copper Concentration ($\mu\text{g/L}$ as Cu)	Mean % Germination	Mean Gametophyte Germ Tube Length (μm)
Lab Water Control	70.2	12.0
5.6	65.0	11.7
10	65.4	11.5
18	60.8*	11.0*
32	61.6*	10.7*
56	50.4*	9.9*
100	33.6*	8.9*
180	20.2*	8.4*
324	5.0*	8.1*
583	0.0*	0.0*
Summary of Statistics		
Germination EC ₅₀ or Growth IC ₅₀ =	107 $\mu\text{g/L}$ Cu	391 $\mu\text{g/L}$ Cu

* The response at this test treatment was significantly less than the Lab Water Control treatment response ($p < 0.05$).



3.2 Chronic Effects of Crescent City Effluent on *Mytilus galloprovincialis*

The results of this test are summarized in Table 4. There was no reduction in normal development at the 3.45% effluent concentration; the TST analysis resulted in a pass. The test data and summary of statistical analyses for this test are attached as Appendix D.

Table 4. Chronic effects of Crescent City effluent on <i>Mytilus galloprovincialis</i> .	
Effluent Treatment	Mean % Normal Embryo Development
Lab Water Control	98.6
3.45%	98.7
Summary of Statistics	
Percent (%) Effect =	no reduction
TST Analysis =	Pass

3.2.1 Reference Toxicant Toxicity to *Mytilus galloprovincialis*

The results of this test are summarized in Table 5. The EC₅₀ for this test was consistent with the typical response range established by the reference toxicant test database for this species, indicating that the organisms used in this testing were responding to toxic stress in a typical fashion. The test data and summary of statistics for this test are attached as Appendix E.

Table 5. Reference toxicant testing: Effects of KCl on <i>Mytilus galloprovincialis</i> .	
KCl Treatment (g/L)	Mean % Normal Embryo Development
Lab Water Control	98.3
0.5	98.3
1	98.1
2	72.4*
3	0*
4	0*
Summary of Statistics	
EC ₅₀ =	2.32 g/L KCl

* The response at this test treatment was significantly less than the Lab Water Control treatment response ($p < 0.05$).

3.3 Chronic Effects of Crescent City Effluent on Topsmelt

The results of this test are summarized in Table 6. There was no reduction in survival and a 8.2% reduction in growth at the 3.45% effluent concentration; the TST analysis resulted in a pass for both endpoints. The test data and summary of statistical analyses for this test are attached as Appendix F.

Table 6. Chronic effects of Crescent City effluent on topsmelt.		
Effluent Treatment	Mean % Survival	Mean Biomass Value (mg)
Lab Water Control	100	1.71
3.45%	100	1.57
Summary of Statistics		
Percent (%) Effect =	No reduction	8.2%
TST Analysis =	Pass	Pass

3.3.1 Reference Toxicant Toxicity to Topsmelt

The results of this test are summarized in Table 7. The EC₅₀ and IC₅₀ for this test were consistent with the typical response ranges established by the reference toxicant test database for this species, indicating that the organisms used in these tests were responding to toxic stress in a typical fashion. The test data and summary of statistics for this test are attached as Appendix G.

Table 7. Reference toxicant testing: Effects of CuCl ₂ on topsmelt.		
CuCl ₂ Concentration (µg/L)	Mean % Survival	Mean Biomass Value (mg)
Lab Water Control	96	1.57
56	88	1.71
100	80	1.53
180	36*	0.51
320	0*	-
560	0*	-
1000	0*	-
Summary of Key Statistics		
Survival EC ₅₀ or Growth IC ₅₀ =	157 µg/L CuCl ₂	155 µg/L CuCl ₂

* The response at this test treatment was significantly less than the Lab Water Control treatment response (p < 0.05).

4. SUMMARY AND CONCLUSIONS

An evaluation of the chronic toxicity of Crescent City effluent was performed using an effluent sample collected August 2, 4, and 7, 2017. The results of this test are summarized below.

Chronic Effects of Crescent City Effluent on Giant Kelp (*Macrocystis pyrifera*)

There was no reduction to germination and a 0.98% reduction in growth at the 3.45% effluent concentration; the TST analysis resulted in a pass for both endpoints.

Chronic Effects of Crescent City Effluent on *Mytilus galloprovincialis*

There was no reduction in normal development at the 3.45% effluent concentration; the TST analysis resulted in a pass.

Chronic Effects of Crescent City Effluent on *Atherinops affinis* (Topsmelt)

There was no reduction in survival and a 8.2% reduction in growth at the 3.45% effluent concentration; the TST analysis resulted in a pass for both endpoints.

4.1 QA/QC Summary

Test Conditions – Test conditions (pH, D.O., temperature, etc.) were within acceptable limits. All analyses were performed according to laboratory Standard Operating Procedures.

Negative Control – The biological responses at the Lab Control treatments were within acceptable limits.

Positive Control – The kelp growth IC₅₀ was slightly above the upper threshold of the typical response range established by the reference toxicant test database for this species, thus suggesting the kelp may have been slightly less sensitive than is typical. The kelp germination EC₅₀ was consistent with the typical response range, indicating that the test organisms were responding to toxic stress in a typical and consistent fashion. The results of the reference toxicant tests for the remaining species were consistent with the typical response ranges established by the reference toxicant test database for these species, indicating that these test organisms were responding to toxic stress in a typical and consistent fashion.

Concentration Response Relationships – The concentration-response relationships for these tests were evaluated per EPA guidelines (EPA-821-B-00-004) and were determined to be acceptable.



Appendix A

Chain-of-Custody Record for the Collection and Delivery of the Sample



Pacific EcoRisk
 2250 Cordelia Rd., Fairfield, CA 94534
 (707) 207-7760 FAX (707) 207-7916

CHAIN-OF-CUSTODY RECORD

Results To: Crescent City Water Quality Control Lab		Invoice To: Same		REQUESTED ANALYSIS												
Address: 377 J Street Crescent City, CA 95531		Address:														
Phone: 707-465-5258		Phone:		Atherinops affinis, EPA 1006.0 Strongylocentrotus purpuratus/Dendraster excentricus, EPA 1008.0 Macrocystis pyrifera, EPA 1009.0												
Attn: Tara Wood		Attn:														
E-mail: sbyrne@crescentcity.org		E-mail:														
Project Name: Crescent City																
P.O.#/Ref: 50871																
Client Sample ID	Sample Date	Sample Time	Sample Matrix*	Grab/Comp	Container											
					Number	Type										
1	8/2/2017	1322	Eff	Grab	1	cubie	X									
2																
3																
4																
5																
6																
7																
8																
9																
10																
Samples collected by: Jesse Wood																
Comments/Special Instruction: Perform testing in accordance with NPDES permit Perform concurrent chronic reference toxicant tests. Cl ₂ = 0.00 ✓				RELINQUISHED BY:					RECEIVED BY: Regina Thill							
				Signature: Jesse Wood					Signature: Regina Thill							
				Print: Jesse Wood					Print: Regina Thill							
				Organization: CCWQP					Organization: CCWQC							
				Date: 8/2/17					Date: 8/2/17							
				Time: 1322					Time:							
				RELINQUISHED BY:					RECEIVED BY: KATE GOMEZ							
				Signature:					Signature: KGomez							
				Print:					Print: KG							
				Organization:					Organization: PER							
Date:					Date: 8/3/17											
Time:					Time: 1020											



Pacific EcoRisk
 2250 Cordelia Rd., Fairfield, CA 94534
 (707) 207-7760 FAX (707) 207-7916

CHAIN-OF-CUSTODY RECORD

Results To: Crescent City Water Quality Control Lab		Invoice To: Same		REQUESTED ANALYSIS																	
Address: 377 J Street Crescent City, CA 95531		Address:																			
Phone: 707-465-5258		Phone:		<i>Atherinops affinis, EPA 1006.0</i> <i>Strongylocentrotus purpuratus/Dendroaster excentricus, EPA 1008.0</i> <i>Macrocystis pyrifera, EPA 1009.0</i> <i>Mytilus spp., EPA 1005.0</i>																	
Attn: Tara Wood		Attn:																			
E-mail: sbyrne@crescentcity.org		E-mail:																			
Project Name: Crescent City																					
P.O.#/Ref: 50871																					
Client Sample ID	Sample Date	Sample Time	Sample Matrix*	Grab/Comp	Container																
					Number	Type															
1 Effluent Grab	8/2/2017	1322	Eff	Grab	1	cube	X		X	X											
2																					
3																					
4																					
5																					
6																					
7																					
8																					
9																					
10																					
Samples collected by: <i>Jesse Wood</i>																					
Comments/Special Instruction: Perform testing in accordance with NPDES permit Perform concurrent chronic reference toxicant tests. <i>Cl₂ = 0.00 ✓</i>							RELINQUISHED BY:					RECEIVED BY: <i>Regina Thill</i>									
							Signature: <i>Jesse Wood</i>					Signature: <i>[Signature]</i>									
							Print: <i>Jesse Wood</i>					Print: <i>Regina Thill</i>									
							Organization: <i>CCWWP</i>					Organization: <i>CCWWP</i>									
Date: <i>8/2/17</i>					Time: <i>1322</i>					Date: <i>8/2/17</i>					Time:						
							RELINQUISHED BY:					RECEIVED BY: <i>KATIE GOMEZ</i>									
							Signature:					Signature: <i>KGomez</i>									
							Print:					Print: <i>KG</i>									
							Organization:					Organization: <i>PER</i>									
Date:					Time:					Date: <i>8/3/17</i>					Time: <i>1020</i>						



Pacific EcoRisk
 2250 Cordelia Rd., Fairfield, CA 94534
 (707) 207-7760 FAX (707) 207-7916

CHAIN-OF-CUSTODY RECORD

Results To: Crescent City Water Quality Control Lab		Invoice To: Same		REQUESTED ANALYSIS												
Address: 377 J Street Crescent City, CA 95531		Address:														
Phone: 707-465-5258		Phone:		Atherinops affinis, EPA 1006.0 Strongylocentrotus purpuratus/Dendraster excentricus, EPA 1008.0 Macrocystis pyrifera, EPA 1009.0												
Attn: Tara Wood		Attn:														
E-mail: sbyrne@crescentcity.org		E-mail:														
Project Name: Crescent City																
P.O.#/Ref: 50871																
Client Sample ID	Sample Date	Sample Time	Sample Matrix*	Grab/Comp	Container											
					Number	Type										
1	8/4/2017	1259	Eff	Grab	1	cubie	X									
2																
3																
4																
5																
6																
7																
8																
9																
10																
Samples collected by: Michael D. Petersen																
Comments/Special Instruction: Perform testing in accordance with NPDES permit Perform concurrent chronic reference toxicant tests. CL= 0.0				RELINQUISHED BY: Michael D. Petersen					RECEIVED BY:							
				Signature: Michael D. Petersen					Signature: [Signature]							
				Print: Michael D. Petersen					Print: Regina Thilly							
				Organization: CWRWP					Organization: CWRAL							
				Date: 08/04/17					Date: 8/4/17							
				Time: 1308					Time: 1300							
				RELINQUISHED BY:					RECEIVED BY:							
				Signature:					Signature: [Signature]							
				Print:					Print: Samantha Cowdin SNE							
				Organization:					Organization: PER							
Date:					Date: 8/5/17											
Time:					Time: 0950											



Pacific EcoRisk
 2250 Cordelia Rd., Fairfield, CA 94534
 (707) 207-7760 FAX (707) 207-7916

CHAIN-OF-CUSTODY RECORD

Results To: Crescent City Water Quality Control Lab		Invoice To: Same		REQUESTED ANALYSIS																						
Address: 377 J Street Crescent City, CA 95531		Address:																								
Phone: 707-465-5258		Phone:		<i>Atherinops affinis, EPA 1006.0</i> <i>Strongylocentrotus purpuratus/Dendroaster excentricus, EPA 1008.0</i> <i>Macrocystis pyrifera, EPA 1009.0</i>																						
Attn: Tara Wood		Attn:																								
E-mail: twood@crescentcity.org		E-mail:																								
Project Name: Crescent City																										
P.O.#/Ref: 50871																										
Client Sample ID	Sample Date	Sample Time	Sample Matrix*	Grab/Comp	Container																					
					Number	Type																				
1 Effluent Grab	8/7/2017	1255	Eff	Grab	1	cubie																				
2																										
3																										
4																										
5																										
6																										
7																										
8																										
9																										
10																										
Samples collected by: Michael D. Petersen																										
Comments/Special Instruction: Perform testing in accordance with NPDES permit Perform concurrent chronic reference toxicant tests. <i>C1=000</i>							RELINQUISHED BY:					RECEIVED BY:														
							Signature: Michael D. Petersen					Signature: <i>[Signature]</i>														
							Print: Michael D. Petersen					Print: Regina Hill														
							Organization: CCWTP					Organization: CCWQL														
							Date: 08/07/17					Time: 1301		Date: 8/7/17		Time: 1301										
							RELINQUISHED BY:					RECEIVED BY:														
							Signature:					Signature: <i>[Signature]</i>														
							Print:					Print: KATE GOMEZ														
							Organization:					Organization: VER														
							Date:					Time:		Date: 8/8/17		Time: 0900										

Appendix B

Test Data and Summary of Statistics for the Evaluation of the Chronic Toxicity of Crescent City Effluent to *Macrocystis pyrifera*

CETIS Summary Report

Report Date: 11 Aug-17 16:36 (p 1 of 1)
 Test Code: 73742 | 13-5698-3540

Macrocyctis Germination and Growth Test										Pacific EcoRisk	
Batch ID:	09-9612-1371	Test Type:	Growth-Germination				Analyst:	Natalie Lynch			
Start Date:	03 Aug-17 15:45	Protocol:	EPA/600/R-95/136 (1995)				Diluent:	Filtered Seawater			
Ending Date:	05 Aug-17 14:45	Species:	Macrocyctis pyrifera				Brine:	Hyper-Saline Brine			
Duration:	47h	Source:	Dave Guttoff				Age:	N/A			
Sample ID:	21-1085-1666	Code:	Effluent				Client:	Crescent City			
Sample Date:	02 Aug-17 13:22	Material:	Effluent				Project:	27678			
Receipt Date:	03 Aug-17 10:20	Source:	City of Crescent City								
Sample Age:	26h (0.8 °C)	Station:	Effluent Grab								
Single Comparison Summary											
Analysis ID	Endpoint	Comparison Method				P-Value	Comparison Result				
06-1725-6349	Germination Rate	Equal Variance t Two-Sample Test				0.0529	Brine Control passed germination rate				
05-0788-7524	Germination Rate	TST-Welch's t Test				1.8E-04	3.45% passed germination rate				
12-9864-4378	Mean Length	Equal Variance t Two-Sample Test				0.6179	Brine Control passed mean length				
08-6807-0118	Mean Length	TST-Welch's t Test				2.8E-07	3.45% passed mean length				
Germination Rate Summary											
Conc-%	Code	Count	Mean	95% LCL	95% UCL	Min	Max	Std Err	Std Dev	CV%	%Effect
0	LW	5	0.732	0.635	0.829	0.630	0.840	0.035	0.078	10.69%	0.00%
0	B	5	0.666	0.642	0.690	0.640	0.690	0.009	0.020	2.93%	9.02%
3.45		5	0.734	0.670	0.798	0.670	0.800	0.023	0.051	6.99%	-0.27%
Mean Length Summary											
Conc-%	Code	Count	Mean	95% LCL	95% UCL	Min	Max	Std Err	Std Dev	CV%	%Effect
0	LW	5	12.2	11.7	12.7	11.8	12.8	0.187	0.418	3.43%	0.00%
0	B	5	12.3	11.8	12.8	11.8	12.8	0.177	0.396	3.23%	-0.66%
3.45		5	12.1	11.8	12.3	11.8	12.3	0.097	0.217	1.79%	0.98%
Germination Rate Detail											
Conc-%	Code	Rep 1	Rep 2	Rep 3	Rep 4	Rep 5					
0	LW	0.750	0.840	0.690	0.630	0.750					
0	B	0.660	0.660	0.640	0.680	0.690					
3.45		0.670	0.800	0.770	0.710	0.720					
Mean Length Detail											
Conc-%	Code	Rep 1	Rep 2	Rep 3	Rep 4	Rep 5					
0	LW	12.3	11.8	11.8	12.8	12.3					
0	B	12	11.8	12.5	12.3	12.8					
3.45		11.8	12	12.3	12	12.3					
Germination Rate Binomials											
Conc-%	Code	Rep 1	Rep 2	Rep 3	Rep 4	Rep 5					
0	LW	75/100	84/100	69/100	63/100	75/100					
0	B	66/100	66/100	64/100	68/100	69/100					
3.45		67/100	80/100	77/100	71/100	72/100					

Macrocystis Germination and Growth Test Pacific EcoRisk

Analysis ID: 05-0788-7524 Endpoint: Germination Rate CETIS Version: CETISv1.9.2
 Analyzed: 11 Aug-17 16:36 Analysis: Parametric Bioequivalence-Two Sample Official Results: Yes

Data Transform	Alt Hyp	TST_b	Comparison Result
Angular (Corrected)	C*b < T	0.75	3.45% passed germination rate

TST-Welch's t Test

Control	vs	Control II	Test Stat	Critical	DF	P-Type	P-Value	Decision(α:5%)
Lab Water Contr		3.45*	6.44	1.89	7	CDF	1.8E-04	Non-Significant Effect

ANOVA Table

Source	Sum Squares	Mean Square	DF	F Stat	P-Value	Decision(α:5%)
Between	1.124E-07	1.124E-07	1	1.94E-05	0.9966	Non-Significant Effect
Error	0.0462864	0.0057858	8			
Total	0.0462865		9			

Distributional Tests

Attribute	Test	Test Stat	Critical	P-Value	Decision(α:1%)
Variances	Variance Ratio F Test	2.37	23.2	0.4231	Equal Variances
Distribution	Shapiro-Wilk W Normality Test	0.99	0.741	0.9970	Normal Distribution

Germination Rate Summary

Conc-%	Code	Count	Mean	95% LCL	95% UCL	Median	Min	Max	Std Err	CV%	%Effect
0	LW	5	0.732	0.635	0.829	0.750	0.630	0.840	0.035	10.69%	0.00%
3.45		5	0.734	0.670	0.798	0.720	0.670	0.800	0.023	6.99%	-0.27%

Angular (Corrected) Transformed Summary

Conc-%	Code	Count	Mean	95% LCL	95% UCL	Median	Min	Max	Std Err	CV%	%Effect
0	LW	5	1.03	0.918	1.14	1.05	0.917	1.16	0.0404	8.76%	0.00%
3.45		5	1.03	0.958	1.1	1.01	0.959	1.11	0.0262	5.68%	-0.02%

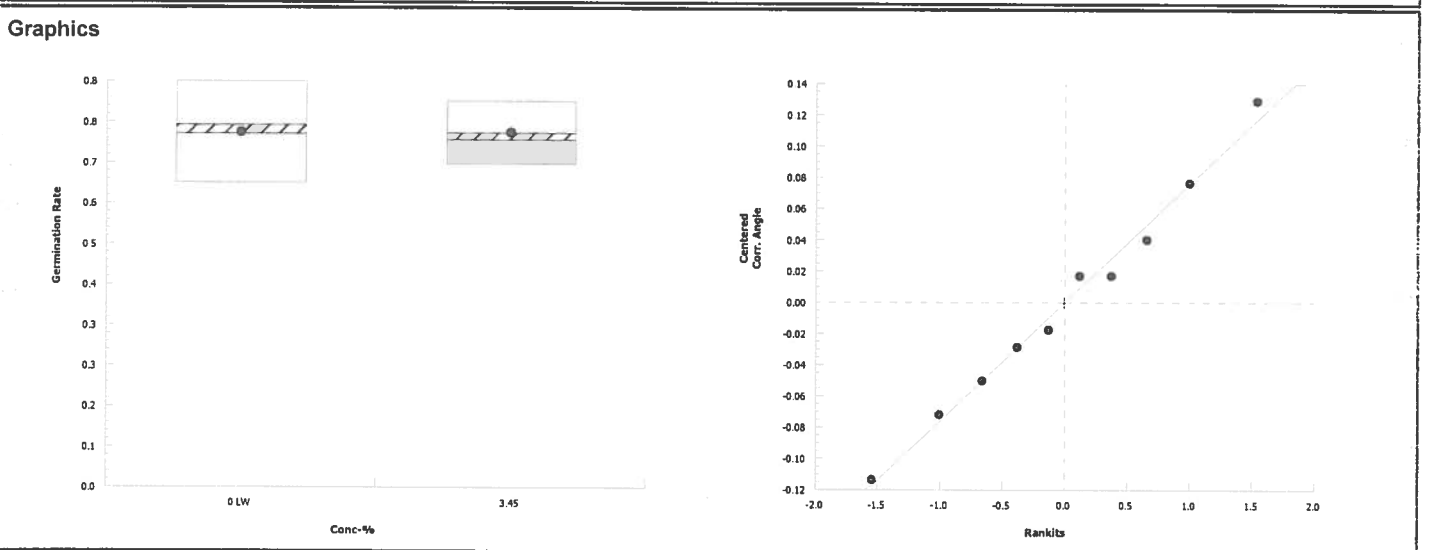

CETIS Analytical Report

Report Date: 11 Aug-17 16:36 (p 3 of 4)
 Test Code: 73742 | 13-5698-3540

Macrocystis Germination and Growth Test Pacific EcoRisk

Analysis ID: 08-6807-0118 Endpoint: Mean Length CETIS Version: CETISv1.9.2
 Analyzed: 11 Aug-17 16:36 Analysis: Parametric Bioequivalence-Two Sample Official Results: Yes

Data Transform	Alt Hyp	TST_b	Comparison Result
Untransformed	C*b < T	0.75	3.45% passed mean length

TST-Welch's t Test

Control	vs	Control II	Test Stat	Critical	DF	P-Type	P-Value	Decision(α:5%)
Lab Water Contr		3.45*	17.2	1.89	7	CDF	2.8E-07	Non-Significant Effect

ANOVA Table

Source	Sum Squares	Mean Square	DF	F Stat	P-Value	Decision(α:5%)
Between	0.036	0.036	1	0.324	0.5847	Non-Significant Effect
Error	0.888	0.111	8			
Total	0.924		9			

Distributional Tests

Attribute	Test	Test Stat	Critical	P-Value	Decision(α:1%)
Variances	Variance Ratio F Test	3.72	23.2	0.2310	Equal Variances
Distribution	Shapiro-Wilk W Normality Test	0.941	0.741	0.5654	Normal Distribution

Mean Length Summary

Conc-%	Code	Count	Mean	95% LCL	95% UCL	Median	Min	Max	Std Err	CV%	%Effect
0	LW	5	12.2	11.7	12.7	12.3	11.8	12.8	0.187	3.43%	0.00%
3.45		5	12.1	11.8	12.3	12	11.8	12.3	0.097	1.79%	0.98%

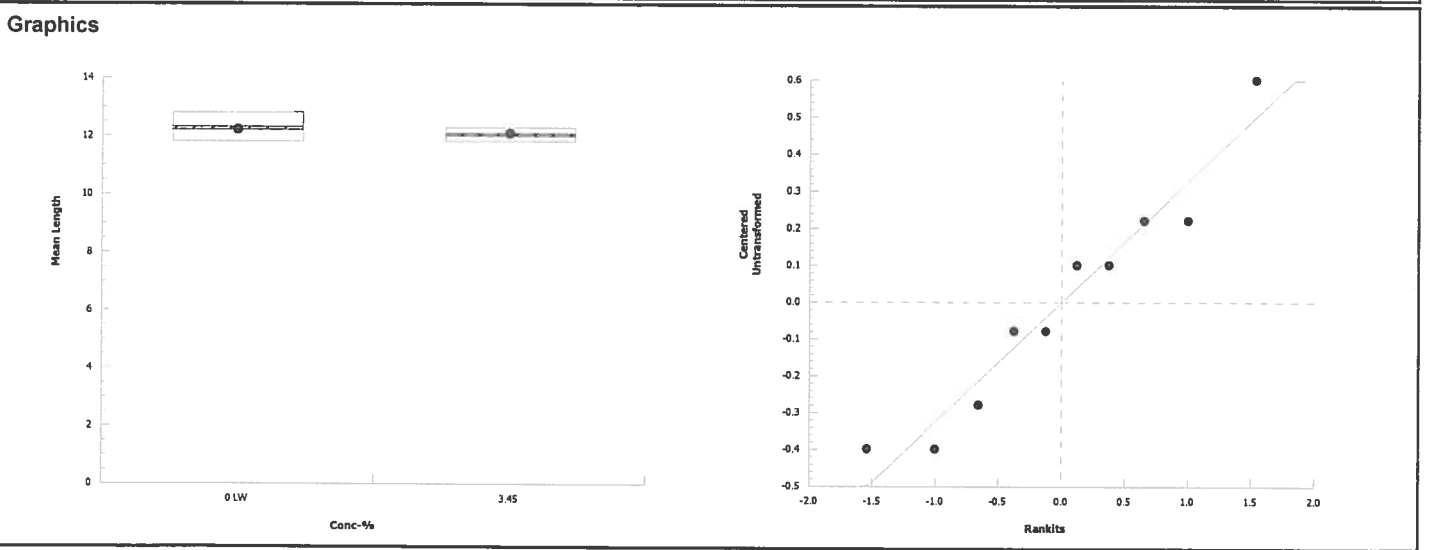

CETIS Analytical Report

Report Date: 11 Aug-17 16:36 (p 2 of 4)
 Test Code: 73742 | 13-5698-3540

Macrocystis Germination and Growth Test Pacific EcoRisk

Analysis ID: 06-1725-6349 Endpoint: Germination Rate CETIS Version: CETISv1.9.2
 Analyzed: 11 Aug-17 9:03 Analysis: Parametric-Two Sample Official Results: Yes

Data Transform: Angular (Corrected) Alt Hyp: C > T Comparison Result: Brine Control passed germination rate PMSD: 9.20%

Equal Variance t Two-Sample Test

Control	vs	Control II	Test Stat	Critical	MSD	DF	P-Type	P-Value	Decision(α:5%)
Lab Water Contr		Brine Control	1.82	1.86	0.077	8	CDF	0.0529	Non-Significant Effect

ANOVA Table

Source	Sum Squares	Mean Square	DF	F Stat	P-Value	Decision(α:5%)
Between	0.0142303	0.0142303	1	3.32	0.1058	Non-Significant Effect
Error	0.0342736	0.0042842	8			
Total	0.0485039		9			

Distributional Tests

Attribute	Test	Test Stat	Critical	P-Value	Decision(α:1%)
Variances	Variance Ratio F Test	19.1	23.2	0.0144	Equal Variances
Distribution	Shapiro-Wilk W Normality Test	0.916	0.741	0.3209	Normal Distribution

Germination Rate Summary

Conc-%	Code	Count	Mean	95% LCL	95% UCL	Median	Min	Max	Std Err	CV%	%Effect
0	LW	5	0.732	0.635	0.829	0.750	0.630	0.840	0.035	10.69%	0.00%
0	B	5	0.666	0.642	0.690	0.660	0.640	0.690	0.009	2.93%	9.02%

Angular (Corrected) Transformed Summary

Conc-%	Code	Count	Mean	95% LCL	95% UCL	Median	Min	Max	Std Err	CV%	%Effect
0	LW	5	1.03	0.918	1.14	1.05	0.917	1.16	0.0404	8.76%	0.00%
0	B	5	0.955	0.929	0.98	0.948	0.927	0.98	0.00924	2.17%	7.32%

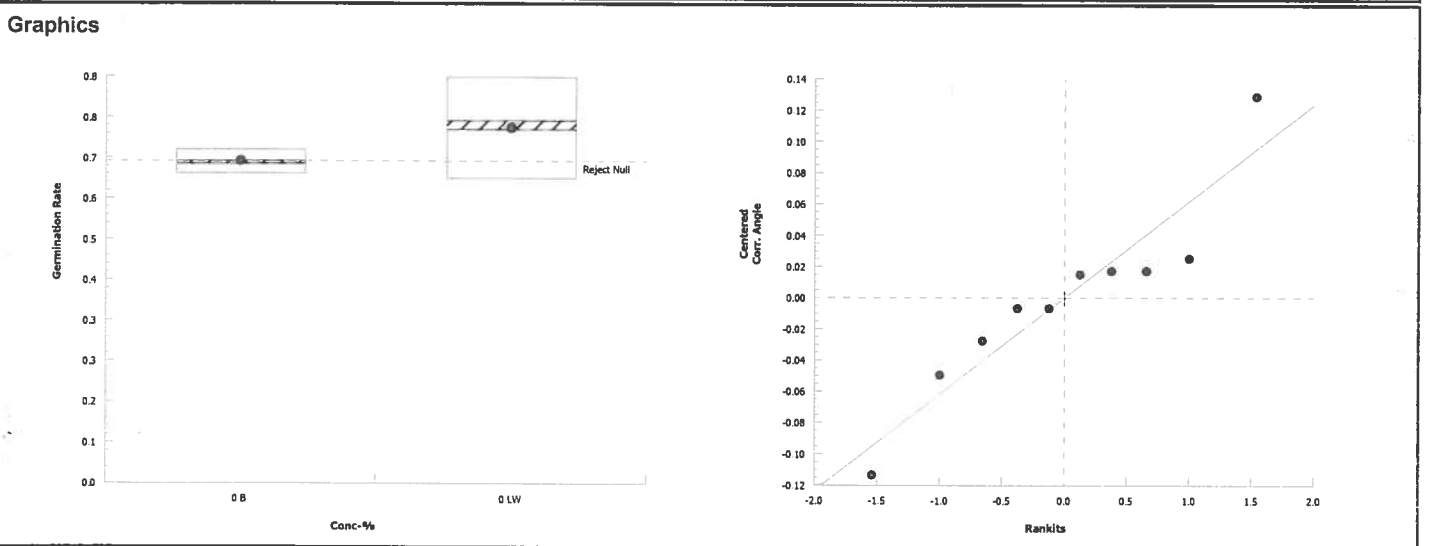

CETIS Analytical Report

Report Date: 11 Aug-17 16:36 (p 4 of 4)
 Test Code: 73742 | 13-5698-3540

Macrocystis Germination and Growth Test Pacific EcoRisk

Analysis ID: 12-9864-4378 Endpoint: Mean Length CETIS Version: CETISv1.9.2
 Analyzed: 11 Aug-17 9:03 Analysis: Parametric-Two Sample Official Results: Yes

Data Transform	Alt Hyp	Comparison Result	PMSD
Untransformed	C > T	Brine Control passed mean length	3.93%

Equal Variance t Two-Sample Test

Control	vs	Control II	Test Stat	Critical	MSD	DF	P-Type	P-Value	Decision(α:5%)
Lab Water Contr		Brine Control	-0.31	1.86	0.479	8	CDF	0.6179	Non-Significant Effect

ANOVA Table

Source	Sum Squares	Mean Square	DF	F Stat	P-Value	Decision(α:5%)
Between	0.016	0.016	1	0.0964	0.7641	Non-Significant Effect
Error	1.328	0.166	8			
Total	1.344		9			

Distributional Tests

Attribute	Test	Test Stat	Critical	P-Value	Decision(α:1%)
Variances	Variance Ratio F Test	1.11	23.2	0.9188	Equal Variances
Distribution	Shapiro-Wilk W Normality Test	0.919	0.741	0.3527	Normal Distribution

Mean Length Summary

Conc-%	Code	Count	Mean	95% LCL	95% UCL	Median	Min	Max	Std Err	CV%	%Effect
0	LW	5	12.2	11.7	12.7	12.3	11.8	12.8	0.187	3.43%	0.00%
0	B	5	12.3	11.8	12.8	12.3	11.8	12.8	0.177	3.23%	-0.66%

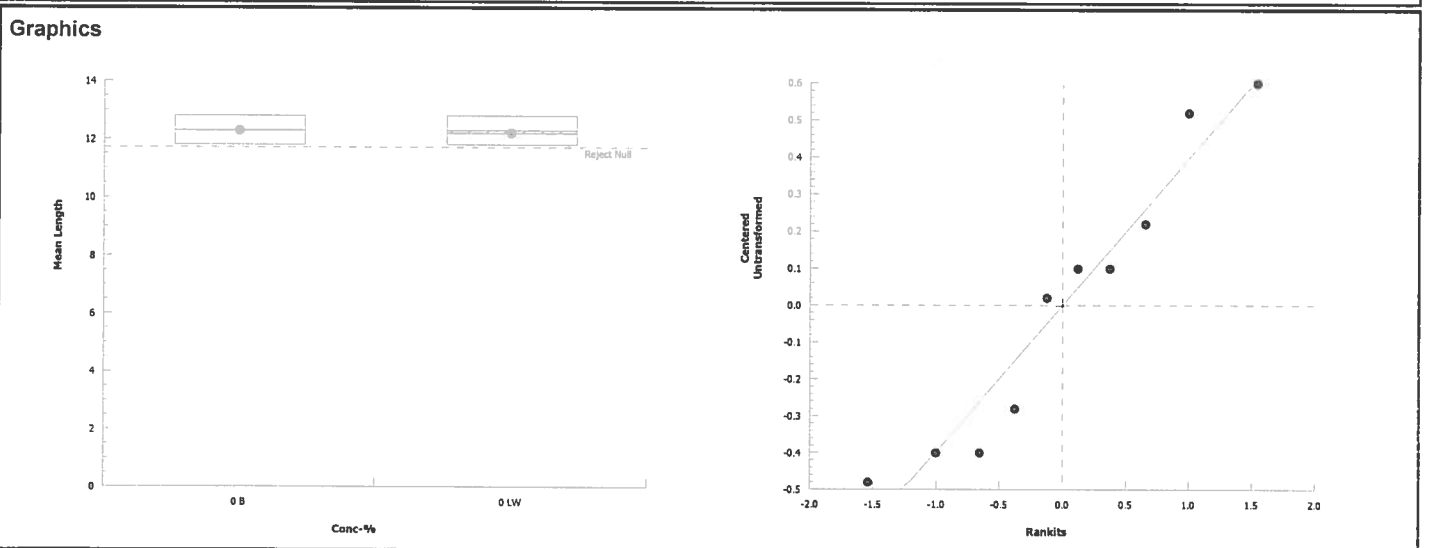

Kelp (*M. pyrifera*) Development Toxicity Test Water Chemistry Data

Client: Crescent City
 Test Material: Effluent
 Test ID#: 73742 Project #: 27678
 Test Date: 8/3/17 Randomization: ·
 Sample Salinity adjusted with: Brine adjusted.

Organism Log#: 10442 Age: N/A
 Organism Supplier: Gutloff
 Control/Diluent: Filtered Seawater
 Light Intensity: 218

Day 0					
Treatment	Temperature (°C)	pH	D.O. (mg/L)	Salinity (ppt)	Signoff
Lab Water Control	14.1	7.62	8.7	32.5	Date & Inoculation Time: <u>8/3/17/154h</u>
Brine Control	14.1	7.85	7.4	31.8 32.4	Solution Prep/Inoculation: <u>SH / SH</u>
Meter ID	82A	PH23	RD12	EC10	New WQ: <u>KG</u>

SH 2/3/17
15L

Day 1					
Treatment	Temperature (°C)	pH	D.O. (mg/L)	Salinity (ppt)	Signoff
Lab Water Control	15.0				Date: <u>8/4/17</u>
Brine Control	15.0				Old WQ: <u>ED</u>
Meter ID	82A				

Day 2					
Treatment	Temperature (°C)	pH	D.O. (mg/L)	Salinity (ppt)	Signoff
Lab Water Control	15.5	7.56	7.7	34.7	Date: <u>8/5/17</u>
Brine Control	15.5	7.56	7.9	34.2	Termination: <u>TR 1445</u>
Meter ID	82A	PH21	RD11	EC12	Old WQ: <u>LJ</u>

Kelp (*M. pyrifera*) Development Toxicity Test Water Chemistry Data

Client: Crescent City
 Test Material: Effluent
 Test ID#: 73742 Project #: 27678
 Test Date: 8/3/17 Randomization: -
 Sample Salinity adjusted with: Brine

Organism Log#: 10442 Age: N/A
 Organism Supplier: Gutloff
 Control/Diluent: Filtered Seawater
 Light Intensity: 218

Day 0					
Treatment	Temperature (°C)	pH	D.O. (mg/L)	Salinity (ppt)	Signoff
Lab Water Control	14.1	7.62	8.7	32.5	Date & Inoculation Time: 8/3/17
3.45%	14.1	7.63	8.4	32.4	Solution Prep/Inoculation: SH
Meter ID	82A	PH23	RD12	EC10	New WQ: KB

SAMPLE 1
47106

Day 1					
Treatment	Temperature (°C)	pH	D.O. (mg/L)	Salinity (ppt)	Signoff
Lab Water Control	15.0				Date: 8/4/17
3.45%	15.0				Old WQ: CD
Meter ID	82A				

Day 2					
Treatment	Temperature (°C)	pH	D.O. (mg/L)	Salinity (ppt)	Signoff
Lab Water Control	15.5	7.56	7.7	34.7	Date: 8/5/17
3.45%	15.5	7.55	7.8	34.9	Termination: TK 1445
Meter ID	82A	PH21	RD11	EC12	Old WQ: YJ

Kelp (*M. pyrifera*) Development Toxicity Test DataClient: Crescent City Test Start Date: 8/3/17 Test End Date: 8/5/17 Enumeration Date: 8/6/17Test Material: Brine Control Test ID #: 73742 Project #: 27678 Investigator: JBLControl Medium: Filtered Seawater fb nity adjusted with: Brine Micrometer Conv. Factor: 2.5

Treatment	Rep	Germination		Length Measurements (in ocular micrometer units)										MEAN	Corrected Mean Length (μm)
		# Spores Germinated	# Spores not Germinated	L1	L2	L3	L4	L5	L6	L7	L8	L9	L10		
Lab Water Control	A	75	25	6	5	4	5	4	5	4	4	5	7	4.9	12.3
	B	84	16	5	4	5	4	5	5	3	4	7	5	4.7	11.8
	C	69	31	5	5	4	5	5	5	4	4	5	5	4.7	11.8
	D	63	37	5	3	6	5	5	6	7	6	4	4	5.1	12.8
	E	75	25	4	5	5	6	5	5	5	5	5	4	4.9	12.3
Brine Control	A	66	34	5	6	4	4	5	5	5	4	4	6	4.8	12.0
	B	66	34	4	6	5	5	5	5	5	5	3	4	4.7	11.8
	C	64	36	5	5	5	4	5	5	6	5	5	5	5.0	12.5
	D	68	32	4	7	4	5	6	5	4	4	5	5	4.9	12.3
	E	69	31	5	6	5	5	6	5	4	6	4	5	5.1	12.8

Kelp (*M. pyrifera*) Development Toxicity Test Data

Client: Crescent City
 Test Material: Effluent
 Test ID #: 73742
 Project #: 27678
 Sample Salinity adjusted with: Brine

Test Start Date: 8/3/17
 Test End Date: ~~8/6/17~~ 8/5/17
 Enumeration Date: ~~JBL~~ JBL 8/6/17
 Investigator: JBL
 Micrometer Conv. Factor: 2.5

Germination			Length Measurements (in ocular micrometer units)										Mean		
Treatment	# Spores Germinated	# Spores not Germinated	L1	L2	L3	L4	L5	L6	L7	L8	L9	L10	MEAN	Mean Length (µm)	
Lab Water Control	1	75	25	6	5	4	5	4	5	4	4	5	7	4.9	12.3
	2	84	16	5	4	5	4	5	5	3	4	7	5	4.7	11.8
	3	69	31	5	5	4	5	5	5	4	4	5	5	4.7	11.8
	4	63	37	5	3	6	5	5	6	7	6	4	4	5.1	12.8
	5	75	25	4	5	5	6	5	5	5	5	5	4	4.9	12.3
3.45%	1	67	33	5	5	4	5	4	5	5	4	4	6	4.7	11.8
	2	80	20	5	5	4	5	4	4	5	6	5	5	4.8	12.0
	3	77	23	6	5	5	4	4	5	5	5	4	6	4.9	12.3
	4	71	29	4	6	6	3	5	4	5	5	5	5	4.8	12.0
	5	72	28	4	5	5	5	4	5	5	5	5	6	4.9	12.3

Appendix C

Test Data and Summary of Statistics for the Reference Toxicant Evaluation of the *Macrocystis pyrifera*

CETIS Summary Report

Report Date: 22 Aug-17 09:00 (p 1 of 2)
 Test Code: 73965 | 15-0107-1601

Macrocystis Germination and Growth Test				Pacific EcoRisk
Batch ID: 18-0450-3560	Test Type: Growth-Germination	Analyst: Stevi Vasquez		
Start Date: 03 Aug-17 15:35	Protocol: EPA/600/R-95/136 (1995)	Diluent: Filtered Seawater		
Ending Date: 05 Aug-17 14:40	Species: Macrocystis pyrifera	Brine: Not Applicable		
Duration: 47h	Source: Gutoff	Age: N/A		
Sample ID: 21-2304-7281	Code: CuCl2	Client: Reference Toxicant		
Sample Date: 03 Aug-17 15:35	Material: Copper chloride	Project: 27741		
Receipt Date: 03 Aug-17 15:35	Source: Reference Toxicant			
Sample Age: n/a (14.1 °C)	Station: In House			

Multiple Comparison Summary							
Analysis ID	Endpoint	Comparison Method	NOEL	LOEL	TOEL	TU	PMSD ✓
01-8683-5930	Germination Rate	Dunnett Multiple Comparison Test	10	18	13.42		8.82%
06-3001-6105	Mean Length	Dunnett Multiple Comparison Test	10	18	13.42		6.08%

Point Estimate Summary							
Analysis ID	Endpoint	Point Estimate Method	Level	µg/L	95% LCL	95% UCL	TU ✓
14-3425-6516	Germination Rate	Regression: Log-Normal (Probit)	EC5	29.6	23.7	35.5	
			EC10	39.3	32.5	45.9	
			EC15	47.6	40.2	54.7	
			EC20	55.4	47.5	62.9	
			EC25	63.1	54.8	71	
			EC40	87.6	78.5	96.4	
16-0615-8042	Mean Length	Linear Interpolation (ICPIN)	IC5	10.4	0.493	27.8	
			IC10	26.6	3.76	50.6	
			IC15	45.9	23.1	70	
			IC20	67.6	39.5	98.4	
			IC25	95.8	61.8	179	
			IC40	353	335	368	
			IC50	391	377	404	

Germination Rate Summary											
Conc-µg/L	Code	Count	Mean	95% LCL	95% UCL	Min	Max	Std Err	Std Dev	CV%	%Effect
0	LW	5	0.702	0.651	0.753	0.660	0.770	0.019	0.042	5.91%	0.00%
5.6		5	0.650	0.630	0.670	0.630	0.670	0.007	0.016	2.43%	7.41%
10		5	0.654	0.598	0.710	0.600	0.720	0.020	0.045	6.89%	6.84%
18		5	0.608	0.538	0.678	0.530	0.680	0.025	0.056	9.26%	13.39%
32		5	0.616	0.564	0.668	0.570	0.680	0.019	0.042	6.75%	12.25%
56		5	0.504	0.440	0.568	0.440	0.570	0.023	0.051	10.18%	28.21%
100		5	0.336	0.307	0.365	0.300	0.360	0.010	0.023	6.85%	52.14%
180		5	0.202	0.160	0.244	0.150	0.230	0.015	0.034	16.57%	71.23%
324		5	0.050	0.030	0.070	0.030	0.070	0.007	0.016	31.62%	92.88%
583		5	0.000	0.000	0.000	0.000	0.000	0.000	0.000		100.00%

Mean Length Summary											
Conc-µg/L	Code	Count	Mean	95% LCL	95% UCL	Min	Max	Std Err	Std Dev	CV%	%Effect
0	LW	5	12	11.1	13	10.8	12.8	0.35	0.783	6.50%	0.00%
5.6		5	11.7	11.1	12.3	11	12.3	0.222	0.497	4.24%	2.66%
10		5	11.5	10.9	12	11	12	0.204	0.456	3.98%	4.82%
18		5	11	10.2	11.8	10.3	11.8	0.285	0.638	5.79%	8.47%
32		5	10.7	10.5	11	10.5	11	0.097	0.217	2.02%	10.96%
56		5	9.88	9.42	10.3	9.3	10.3	0.166	0.37	3.75%	17.94%
100		5	8.94	8.35	9.53	8.3	9.5	0.211	0.472	5.28%	25.75%
180		5	8.36	7.84	8.88	8	9	0.186	0.416	4.98%	30.56%
324		5	8.12	7.78	8.46	7.8	8.5	0.124	0.277	3.42%	32.56%
583		5	0	0	0	0	0	0	0		100.00%

CETIS Summary Report

Report Date: 22 Aug-17 09:00 (p 2 of 2)
 Test Code: 73965 | 15-0107-1601

Macrocystis Germination and Growth Test							Pacific EcoRisk
Germination Rate Detail							
Conc-µg/L	Code	Rep 1	Rep 2	Rep 3	Rep 4	Rep 5	
0	LW	0.770	0.700	0.680	0.660	0.700	
5.6		0.660	0.630	0.650	0.640	0.670	
10		0.720	0.630	0.600	0.670	0.650	
18		0.680	0.580	0.530	0.620	0.630	
32		0.680	0.600	0.570	0.600	0.630	
56		0.440	0.540	0.490	0.570	0.480	
100		0.340	0.330	0.350	0.360	0.300	
180		0.230	0.230	0.210	0.190	0.150	
324		0.030	0.070	0.050	0.060	0.040	
583		0.000	0.000	0.000	0.000	0.000	
Mean Length Detail							
Conc-µg/L	Code	Rep 1	Rep 2	Rep 3	Rep 4	Rep 5	
0	LW	12.8	12.5	11.8	10.8	12.3	
5.6		12.3	11.8	11.5	12	11	
10		11.8	12	11.5	11	11	
18		11.8	11.5	10.3	11	10.5	
32		10.8	10.8	10.5	11	10.5	
56		10	9.3	9.8	10	10.3	
100		9.3	8.8	8.3	9.5	8.8	
180		8.5	8.3	9	8	8	
324		8.5	8	8.3	8	7.8	
583		0	0	0	0	0	
Germination Rate Binomials							
Conc-µg/L	Code	Rep 1	Rep 2	Rep 3	Rep 4	Rep 5	
0	LW	77/100	70/100	68/100	66/100	70/100	
5.6		66/100	63/100	65/100	64/100	67/100	
10		72/100	63/100	60/100	67/100	65/100	
18		68/100	58/100	53/100	62/100	63/100	
32		68/100	60/100	57/100	60/100	63/100	
56		44/100	54/100	49/100	57/100	48/100	
100		34/100	33/100	35/100	36/100	30/100	
180		23/100	23/100	21/100	19/100	15/100	
324		3/100	7/100	5/100	6/100	4/100	
583		0/100	0/100	0/100	0/100	0/100	

Macrocystis Germination and Growth Test

Pacific EcoRisk

Test Type: Growth-Germination

Organism: Macrocystis pyrifera (Giant Kelp)

Material: Copper chloride

Protocol: EPA/600/R-95/136 (1995)

Endpoint: Germination Rate

Source: Reference Toxicant-REF

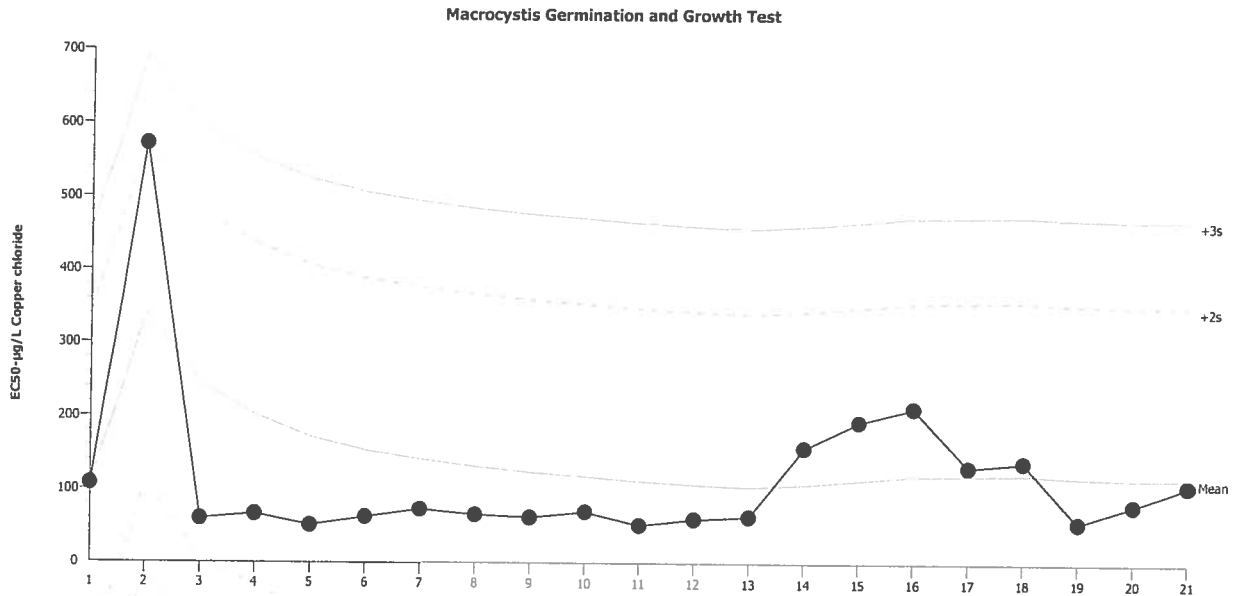

Mean: 117.2 Count: 20 -2s Warning Limit: -117.8 -3s Action Limit: -235.3
 Sigma: 117.5 CV: 100.00% +2s Warning Limit: 352.2 +3s Action Limit: 469.7

Quality Control Data

Point	Year	Month	Day	Time	QC Data	Delta	Sigma	Warning	Action	Test ID	Analysis ID
1	2013	Feb	6	16:15	107.7	-9.515	-0.08098			11-3056-1267	03-3281-0263
2		Jul	24	15:10	572.1	454.9	3.872	(+)	(+)	13-4610-5540	07-9402-7487
3	2015	Nov	5	15:25	60.03	-57.17	-0.4866			17-6449-9142	08-5336-1355
4		Dec	29	15:30	66.44	-50.76	-0.432			05-6611-4336	12-7788-9754
5	2016	Jan	14	15:25	51.34	-65.86	-0.5605			17-6824-0217	02-7384-9815
6		Feb	11	17:55	62.82	-54.38	-0.4628			09-8398-8624	10-8778-7063
7		May	11	17:01	73.46	-43.74	-0.3723			10-0416-5084	03-7997-2979
8		Oct	26	16:30	66.49	-50.71	-0.4316			13-5580-5678	11-9854-6523
9		Nov	30	16:00	62.96	-54.24	-0.4616			09-1674-9341	03-7124-9614
10	2017	Feb	15	16:00	70.55	-46.65	-0.397			11-9574-3901	05-9177-7581
11			22	15:48	52.57	-64.63	-0.5501			11-3123-4750	17-9941-0805
12		Mar	1	16:25	60.97	-56.23	-0.4785			18-8365-7497	06-8570-1961
13			24	15:50	64.33	-52.87	-0.45			16-2369-0361	17-0636-9263
14		May	2	16:04	158.2	40.95	0.3485			08-4127-1529	07-3821-7000
15			26	15:03	193.7	76.48	0.6509			13-7852-2602	20-9291-4116
16		Jun	7	14:43	212.6	95.37	0.8116			13-0976-8856	13-9847-2620
17			23	16:05	132.1	14.93	0.1271			08-7809-1342	15-9943-5845
18			24	15:10	139	21.75	0.1851			03-4267-7264	00-1846-5354
19			28	15:37	56.67	-60.53	-0.5151			01-4920-6397	08-3582-2455
20		Jul	25	13:00	80.58	-36.62	-0.3116			13-8051-0617	11-3079-9084
21		Aug	3	15:35	106.8	-10.4	-0.08848			15-0107-1601	14-3425-6516

Macrocystis Germination and Growth Test

Pacific EcoRisk

Test Type: Growth-Germination

Organism: Macrocystis pyrifera (Giant Kelp)

Material: Copper chloride

Protocol: EPA/600/R-95/136 (1995)

Endpoint: Mean Length

Source: Reference Toxicant-REF

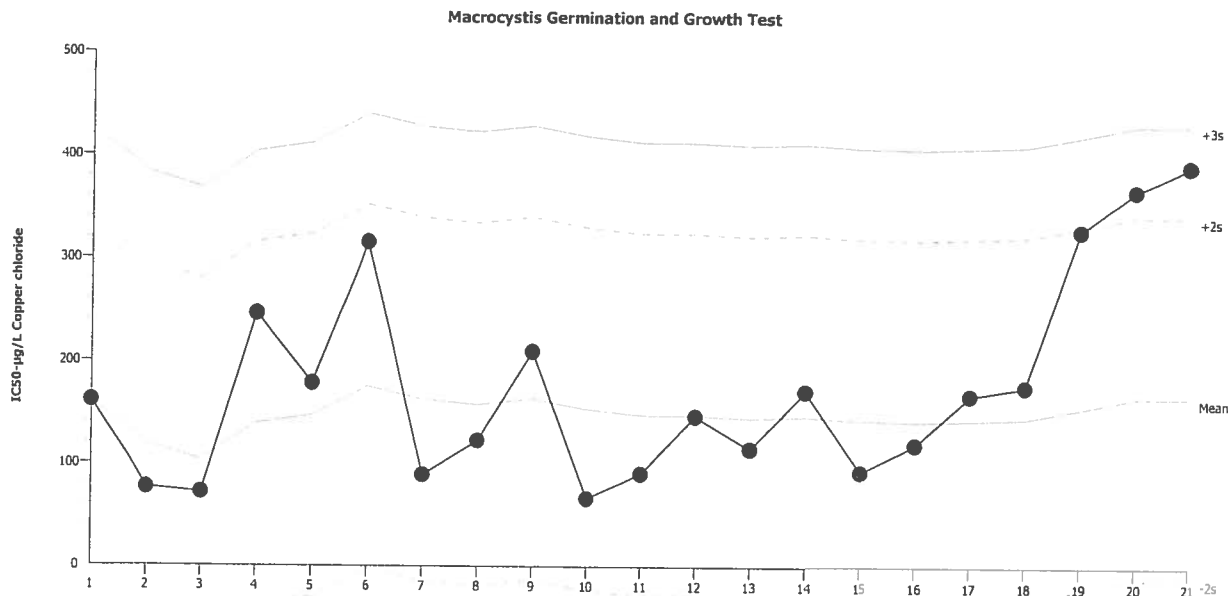

Mean: 165.7 Count: 20 -2s Warning Limit: -11.17 -3s Action Limit: -99.6
 Sigma: 88.43 CV: 53.40% +2s Warning Limit: 342.5 +3s Action Limit: 431

Quality Control Data

Point	Year	Month	Day	Time	QC Data	Delta	Sigma	Warning	Action	Test ID	Analysis ID
1	2008	Jun	12	17:15	161.3	-4.438	-0.05019			18-5783-5617	06-1120-4428
2			26	17:00	76.58	-89.12	-1.008			20-8778-4476	05-7765-8427
3		Jul	15	16:45	71.94	-93.76	-1.06			13-6777-6005	04-0510-3146
4		Nov	16	16:00	246.3	80.62	0.9116			13-6678-8116	09-9413-7824
5			19	15:30	178.4	12.66	0.1432			10-1292-9152	11-2772-9114
6	2009	Feb	11	14:40	315.4	149.7	1.693			05-7166-1623	02-8196-9725
7			28	15:15	89.09	-76.61	-0.8664			12-1143-1603	19-7989-7320
8		Mar	14	18:35	122.4	-43.26	-0.4892			19-5641-8483	02-6572-0942
9			31	17:10	209.6	43.86	0.4959			17-0663-7956	19-9052-0522
10		Apr	11	14:20	66.53	-99.17	-1.121			04-4563-2744	01-0372-1594
11			23	17:30	90.5	-75.2	-0.8504			17-7966-2450	02-9784-1910
12		May	6	16:10	146.8	-18.95	-0.2143			03-3186-2961	09-7124-6571
13	2015	Dec	29	15:30	115.1	-50.61	-0.5723			05-6611-4336	09-4158-5062
14	2016	Jan	14	15:25	171.3	5.625	0.06361			17-6824-0217	08-0278-3221
15		Oct	26	16:30	93.05	-72.65	-0.8215			13-5580-5678	09-9943-0268
16	2017	Feb	22	15:48	119.8	-45.95	-0.5196			11-3123-4750	05-5940-5872
17		Jun	23	16:05	167.7	1.992	0.02253			08-7809-1342	13-1588-8030
18			24	15:10	176.4	10.66	0.1206			03-4267-7264	15-8439-5844
19			28	15:37	328.5	162.8	1.841			01-4920-6397	20-3942-8144
20		Jul	25	13:00	367.3	201.6	2.28	(+)		13-8051-0617	01-2169-6257
21		Aug	3	15:35	391	225.3	2.548	(+)		15-0107-1601	16-0615-8042

Kelp (*M. pyrifera*) Development Reference Toxicant Test Water Chemistry Data

Client: Reference Toxicant
 Test Material: Copper (as CuCl₂)
 Test ID#: 73965 Project #: 27741
 Test Date: 8/3/17 Randomization: -

Organism Log#: 10442 Age: N/A
 Organism Supplier: gutloff
 Control/Diluent: Filtered Seawater
 Light Intensity: 216

Day 0					
Treatment (µg Cu/L)	Temperature (°C)	pH	D.O. (mg/L)	Salinity (ppt)	Signoff
Control	14.1	7.65	9.2	32.4	Test Solution Prep SH
5.6	14.1	7.66	9.3	32.8	New WQ SF
10	14.1	7.67	9.3	32.8	Innoculation Date 8/3/17
18	14.1	7.67	9.3	32.8	Innoculation Time 1535
32	14.1	7.67	9.2	32.8	Innoculation Signoff SH
56	14.1	7.67	9.2	32.8	
100	14.1	7.67	9.5	32.7	
180	14.1	7.67	9.4	32.9	
324	14.1	7.67	9.3	32.9	
583	14.1	7.65	9.3	32.8	
Meter ID	82A	pH23	PD12	EC10	

Day 1					
Treatment (µg Cu/L)	Temperature (°C)	pH	D.O. (mg/L)	Salinity (ppt)	Signoff
Control	15.0				Date 8/4/17
5.6	15.0				WQ Signoff CO
10	15.0				
18	15.0				
32	15.0				
56	15.0				
100	15.0				
180	15.0				
324	15.0				
583	15.0				
Meter ID	82A				

Day 2					
Treatment (µg Cu/L)	Temperature (°C)	pH	D.O. (mg/L)	Salinity (ppt)	Signoff
Control	15.5	7.26	7.9	35.9	Termination Date 8/5/17
5.6	15.5	7.41	7.9	34.1	Termination Time 1440
10	15.5	7.48	7.9	34.9	Termination Signoff TK
18	15.5	7.52	7.9	36.7	Old WQ YJ
32	15.5	7.58	7.9	34.9	
56	15.5	7.60	7.9	34.0	
100	15.5	7.61	7.9	33.7	
180	15.5	7.60	7.9	33.9	
324	15.5	7.58	7.7	33.9	
583	15.5	7.58	7.7	33.9	
Meter ID	82A	pH21	PD11	EC12	

Kelp (*M. pyrifera*) Development Toxicity Test Data

Client: Reference Toxicant

Test Start Date: 8/3/17

Test End Date: 8/5/17

Enumeration Date: 8/6/17

Test Material: Copper (as CuCl₂)

Test ID #: 73965

Project #: 27741

Investigator: JBL

Control Medium: Filtered Seawater

Micrometer Conv. Factor: 2.5

µg Cu/L	Rep	Germination		Length Measurements (in ocular micrometer units)										MEAN	Corrected Mean Length (µm)
		# Spores Germinated	# Spores not Germinated	L1	L2	L3	L4	L5	L6	L7	L8	L9	L10		
Control	A	77	23	6	6	5	5	5	3	7	4	5	5	5.1	12.8
	B	70	30	5	6	6	5	4	5	4	5	5	5	5.0	12.5
	C	68	32	5	5	5	4	4	5	5	5	5	4	4.7	11.8
	D	66	34	4	3	3	6	4	5	4	5	4	5	4.3	10.8
	E	70	30	5	4	5	4	4	7	5	4	5	6	4.9	12.3
5.6	A	66	34	5	6	4	5	5	5	4	5	5	5	4.9	12.3
	B	63	37	5	3	5	4	5	5	5	6	5	4	4.7	11.8
	C	65	35	7	4	3	4	5	5	4	4	5	5	4.6	11.5
	D	64	36	5	4	5	6	5	5	4	5	4	5	4.8	12.0
	E	67	33	5	4	5	5	6	4	3	4	4	4	4.4	11.0
10	A	72	28	4	5	4	4	5	6	6	5	4	4	4.7	11.8
	B	63	37	5	5	5	5	5	5	4	6	3	5	4.8	12.0
	C	60	40	5	5	4	5	4	4	5	6	4	4	4.6	11.5
	D	67	33	5	5	3	4	3	4	6	5	4	5	4.4	11.0
	E	65	35	5	5	4	3	5	4	3	6	5	4	4.4	11.0
18	A	68	32	5	4	4	5	5	4	4	6	5	5	4.7	11.8
	B	58	42	5	5	4	5	4	4	6	3	4	6	4.6	11.5
	C	53	47	4	3	3	3	4	6	5	4	4	5	4.1	10.3
	D	62	38	4	5	3	5	5	4	5	5	4	4	4.4	11.0
	E	63	37	4	4	3	4	4	4	5	5	5	4	4.2	10.5
32	A	68	32	4	5	4	3	5	6	4	3	5	4	4.3	10.8
	B	60	40	4	4	4	4	5	4	5	5	3	5	4.3	10.8
	C	57	43	5	3	5	5	3	4	4	5	4	4	4.2	10.5
	D	60	40	5	4	5	4	4	4	5	3	5	5	4.4	11.0
	E	63	37	3	4	4	4	5	4	4	5	4	5	4.2	10.5
56	A	44	56	3	3	5	4	5	3	3	5	5	4	4.0	10.0
	B	54	46	3	4	3	3	4	3	3	5	5	4	3.7	9.3
	C	49	51	3	5	4	4	4	4	4	5	3	3	3.9	9.8
	D	57	43	4	3	4	5	4	4	4	3	4	5	4.0	10.0
	E	48	52	5	5	3	3	5	4	4	5	3	4	4.2	10.5

JBL 8/7
10.0

JBL 8/7
10.0

Kelp (*M. pyrifera*) Development Toxicity Test Data

Client: Reference Toxicant Test Start Date: 8/3/17 Test End Date: 8/5/17 Enumeration Date: 8/6/17
 Test Material: Copper chloride Test ID #: 73965 Project #: 27741 Investigator: JBL
 Control Medium: Filtered Seawater Micrometer Conv. Factor: 2.5

		Germination		Length Measurements (in ocular micrometer units)											
$\mu\text{g Cu/L}$	Rep	# Spores Germinated	# Spores not Germinated	L1	L2	L3	L4	L5	L6	L7	L8	L9	L10	MEAN	Corrected Mean Length (μm)
100	A	34	60	3	5	4	3	3	3	5	4	3	4	3.7	9.3
	B	33	67	3	3	3	4	5	3	4	4	3	3	3.5	8.8
	C	35	65	3	3	4	4	3	3	4	3	3	3	3.3	8.3
	D	36	64	4	5	4	3	4	3	4	4	4	3	3.8	9.5
	E	30	70	3	3	3	3	3	4	3	4	5	4	3.5	8.8
180	A	23	77	3	4	3	3	3	5	3	3	4	3	3.4	8.5
	B	23	77	4	3	3	3	3	4	3	3	4	3	3.3	8.3
	C	21	79	3	3	3	3	4	5	4	4	4	3	3.6	9.0
	D	19	81	3	3	3	3	4	3	4	3	3	3	3.2	8.0
	E	15	85	3	3	3	3	3	4	3	4	3	3	3.2	8.0
324	A	3	97	3	3	3	3	4	4	3	4	4	3	3.4	8.5
	B	7	93	3	3	3	4	3	3	4	3	3	3	3.2	8.0
	C	5	95	3	3	4	3	3	4	3	3	4	3	3.3	8.3
	D	6	94	4	3	3	3	4	3	3	3	3	3	3.2	8.0
	E	4	96	3	3	3	3	3	4	3	3	3	3	3.1	7.8
583	A	0	100	-	-	-	-	-	-	-	-	-	-	-	-
	B	0	100	-	-	-	-	-	-	-	-	-	-	-	-
	C	0	100	-	-	-	-	-	-	-	-	-	-	-	-
	D	0	100	-	-	-	-	-	-	-	-	-	-	-	-
	E	0	100	-	-	-	-	-	-	-	-	-	-	-	-

Appendix D

Test Data and Summary of Statistics for the Evaluation of the Chronic Toxicity of Crescent City Effluent to *Mytilus galloprovincialis*

CETIS Summary Report

Report Date: 11 Aug-17 16:40 (p 1 of 1)
 Test Code: 73743 | 11-6710-8603

Bivalve Larval Survival and Development Test						Pacific EcoRisk					
Batch ID:	17-6200-5593	Test Type:	Development-Survival			Analyst:	Natalie Lynch				
Start Date:	03 Aug-17 14:20	Protocol:	EPA/600/R-95/136 (1995)			Diluent:	Diluted Seawater				
Ending Date:	05 Aug-17 13:35	Species:	Mytilus galloprovincialis			Brine:	Not Applicable				
Duration:	47h	Source:	M-REP			Age:	N/A				
Sample ID:	18-9366-2470	Code:	Effluent			Client:	Crescent City				
Sample Date:	02 Aug-17 13:22	Material:	Effluent			Project:	27678				
Receipt Date:	03 Aug-17 10:20	Source:	City of Crescent City								
Sample Age:	25h (0.8 °C)	Station:	Effluent Grab								
Single Comparison Summary											
Analysis ID	Endpoint	Comparison Method				P-Value	Comparison Result				
17-0725-9625	Development Rate	TST-Welch's t Test				3.5E-06	3.45% passed development rate				
Development Rate Summary											
Conc-%	Code	Count	Mean	95% LCL	95% UCL	Min	Max	Std Err	Std Dev	CV%	%Effect
0	LW	4	0.986	0.973	0.999	0.976	0.996	0.004	0.008	0.82%	0.00%
3.45		4	0.987	0.977	0.996	0.980	0.992	0.003	0.006	0.60%	-0.08%
Development Rate Detail											
Conc-%	Code	Rep 1	Rep 2	Rep 3	Rep 4						
0	LW	0.976	0.985	0.987	0.996						
3.45		0.984	0.992	0.991	0.980						
Development Rate Binomials											
Conc-%	Code	Rep 1	Rep 2	Rep 3	Rep 4						
0	LW	246/252	256/260	230/233	239/240						
3.45		250/254	235/237	232/234	239/244						

CETIS Analytical Report

Report Date: 11 Aug-17 16:40 (p 1 of 1)
 Test Code: 73743 | 11-6710-8603

Bivalve Larval Survival and Development Test Pacific EcoRisk

Analysis ID: 17-0725-9625 Endpoint: Development Rate CETIS Version: CETISv1.9.2
 Analyzed: 11 Aug-17 16:40 Analysis: Parametric Bioequivalence-Two Sample Official Results: Yes

Data Transform	Alt Hyp	TST_b	Comparison Result
Angular (Corrected)	C*b < T	0.75	3.45% passed development rate

TST-Welch's t Test

Control	vs	Control II	Test Stat	Critical	DF	P-Type	P-Value	Decision(α:5%)
Lab Water Contr		3.45*	19.2	2.02	5	CDF	3.5E-06	Non-Significant Effect

ANOVA Table

Source	Sum Squares	Mean Square	DF	F Stat	P-Value	Decision(α:5%)
Between	1.572E-06	1.572E-06	1	0.00153	0.9701	Non-Significant Effect
Error	0.0061828	0.0010305	6			
Total	0.0061844		7			

Distributional Tests

Attribute	Test	Test Stat	Critical	P-Value	Decision(α:1%)
Variances	Variance Ratio F Test	2.15	47.5	0.5449	Equal Variances
Distribution	Shapiro-Wilk W Normality Test	0.969	0.645	0.8921	Normal Distribution

Development Rate Summary

Conc-%	Code	Count	Mean	95% LCL	95% UCL	Median	Min	Max	Std Err	CV%	%Effect
0	LW	4	0.986	0.973	0.999	0.986	0.976	0.996	0.004	0.82%	0.00%
3.45		4	0.987	0.977	0.996	0.988	0.980	0.992	0.003	0.60%	-0.08%

Angular (Corrected) Transformed Summary

Conc-%	Code	Count	Mean	95% LCL	95% UCL	Median	Min	Max	Std Err	CV%	%Effect
0	LW	4	1.46	1.4	1.52	1.45	1.42	1.51	0.0188	2.58%	0.00%
3.45		4	1.46	1.42	1.5	1.46	1.43	1.48	0.0128	1.75%	-0.06%

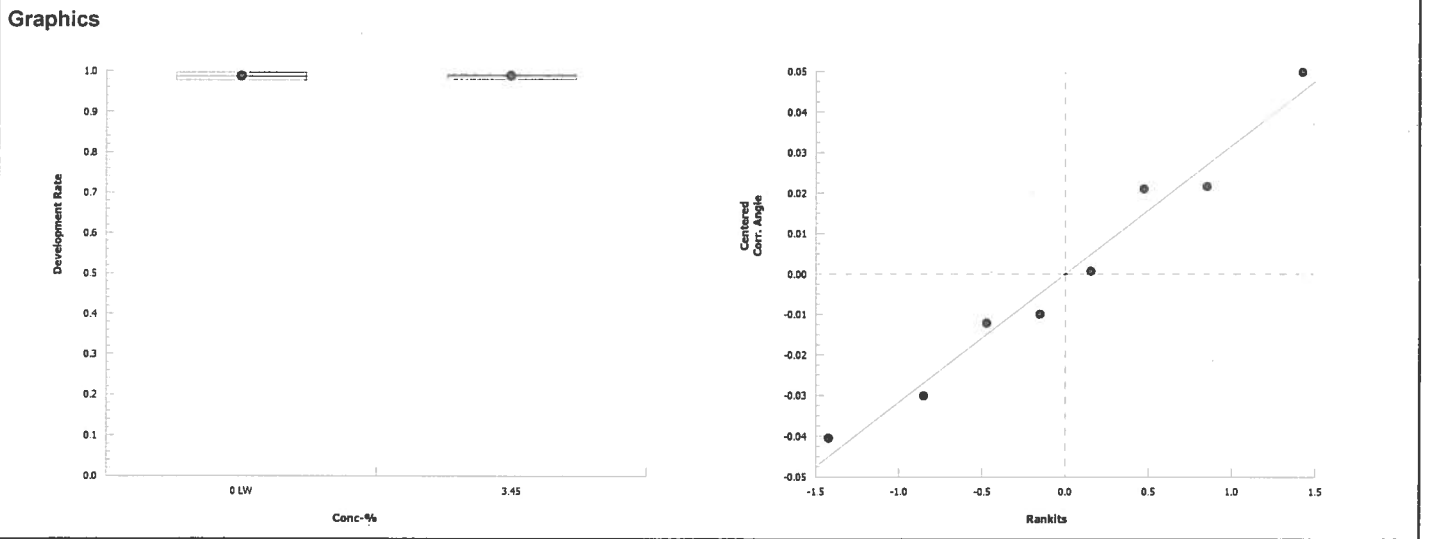

Mytilus sp. Development Toxicity Test Water Chemistry Data

Client: Crescent City
 Test Material: Effluent
 Test ID#: 73743 Project #: 27678
 Test Date: 8/3/17 Randomization: -
 Sample Salinity adjusted with : -

Organism Log#: 10280 Age: N/A
 Organism Supplier: M-Rep
 Control/Diluent: 30 ppt FSW
 Light Intensity: -

Day 0					
Treatment	Temperature (°C)	pH	D.O. (mg/L)	Salinity (ppt)	Signoff
Control	18.9	7.76	7.7	29.8	Date & Inoculation Time: <u>7:00 8/3/17 1420</u>
3.45%	18.9	7.79	7.6	29.4	Solution Prep/Inoculation: <u>Sample 2 PD: CD 47106</u>
Meter ID	69A	PH21	RD11	EC11	New WQ: <u>WL</u>

Day 1					
Treatment	Temperature (°C)	pH	D.O. (mg/L)	Salinity (ppt)	Signoff
Control	18.8				Date: <u>8/4/17</u>
3.45%	18.8				Old WQ: <u>CD</u>
Meter ID	69A				

Day 2					
Treatment	Temperature (°C)	pH	D.O. (mg/L)	Salinity (ppt)	Signoff
Control	18.8	7.66	7.5	30.3	Date: <u>8/5/17 1335</u>
3.45%	18.8	7.74	7.4	29.6	Termination: <u>TK</u>
Meter ID	69A	PH21	RD11	EC12	Old WQ: <u>CD</u>

Mytilus sp. Development Toxicity Test Count Data

Client: Crescent City
 Test Material: Effluent
 Test ID #: 73743
 Project #: 27678

Test Start Date: 8/3/17
 Test End Date: 8/5/17
 Enumeration Date: 8/7/17
 Investigator: JA

Sample Salinity adjusted with: -

Concentration	Replicate	Number of Normal Larvae	Number of Abnormal Larvae	Total Number Larvae	Percent Normal Development
Control	A	246	6	252	97.6
	B	256	4	260	98.5
	C	230	3	233	98.7
	D	239 + 1 ^{sin}	1	240	99.6
	E	—	—	—	—
3.45	A	247 250	4	254	98.4
	B	235	2	237	99.2
	C	232	2	234	99.1
	D	239	5	244	98.0
	E	—	—	—	—

Appendix E

Test Data and Summary of Statistics for the Reference Toxicant Evaluation of the *Mytilus galloprovincialis*

CETIS Summary Report

Report Date: 08 Aug-17 09:40 (p 1 of 1)
 Test Code: 73966 | 05-6483-9921

Bivalve Larval Survival and Development Test Pacific EcoRisk

Batch ID: 02-2643-4441	Test Type: Development-Survival	Analyst: Stevi Vasquez
Start Date: 03 Aug-17 14:21	Protocol: EPA/600/R-95/136 (1995)	Diluent: Diluted Seawater
Ending Date: 05 Aug-17 13:30	Species: Mytilus galloprovincialis	Brine: Not Applicable
Duration: 47h	Source: M-REP	Age: N/A

Sample ID: 03-8216-9610	Code: KCI	Client: Reference Toxicant
Sample Date: 03 Aug-17 14:21	Material: Potassium chloride	Project: 27742
Receipt Date: 03 Aug-17 14:21	Source: Reference Toxicant	
Sample Age: n/a (18.9 °C)	Station: In House	

Multiple Comparison Summary

Analysis ID	Endpoint	Comparison Method	NOEL	LOEL	TOEL	TU	PMSD ✓
05-5388-2036	Development Rate	Dunnett Multiple Comparison Test	1	2	1.414		2.63%

Point Estimate Summary

Analysis ID	Endpoint	Point Estimate Method	Level	g/L	95% LCL	95% UCL	TU	✓
21-1149-5788	Development Rate	Linear Interpolation (ICPIN)	EC5	1.18	1.1	1.27		
			EC10	1.37	1.28	1.54		
			EC15	1.56	1.43	1.82		
			EC20	1.75	1.59	2.09		
			EC25	1.93	1.74	2.13		
			EC40	2.18	2.11	2.28		
EC50	2.32	2.26	2.4					

Development Rate Summary

Conc-g/L	Code	Count	Mean	95% LCL	95% UCL	Min	Max	Std Err	Std Dev	CV%	%Effect
0	LW	4	0.983	0.971	0.995	0.975	0.991	0.004	0.008	0.76%	0.00%
0.5		4	0.983	0.977	0.990	0.978	0.987	0.002	0.004	0.41%	0.00%
1		4	0.981	0.957	1.000	0.960	0.996	0.008	0.015	1.56%	0.19%
2		4	0.724	0.622	0.826	0.677	0.818	0.032	0.064	8.83%	26.38%
3		4	0.000	0.000	0.000	0.000	0.000	0.000	0.000		100.00%
4		4	0.000	0.000	0.000	0.000	0.000	0.000	0.000		100.00%

Development Rate Detail

Conc-g/L	Code	Rep 1	Rep 2	Rep 3	Rep 4
0	LW	0.975	0.979	0.988	0.991
0.5		0.985	0.987	0.978	0.984
1		0.987	0.960	0.983	0.996
2		0.818	0.705	0.677	0.696
3		0.000	0.000	0.000	0.000
4		0.000	0.000	0.000	0.000

Development Rate Binomials

Conc-g/L	Code	Rep 1	Rep 2	Rep 3	Rep 4
0	LW	234/240	232/237	239/242	226/228
0.5		259/263	227/230	261/267	240/244
1		220/223	215/224	230/234	239/240
2		153/187	155/220	155/229	151/217
3		0/216	0/224	0/220	0/210
4		0/1	0/1	0/1	0/1

Bivalve Larval Survival and Development Test		Pacific EcoRisk	
Test Type: Development-Survival	Organism: Mytilus galloprovincialis (Bay Mussel)	Material: Potassium chloride	
Protocol: EPA/600/R-95/136 (1995)	Endpoint: Development Rate	Source: Reference Toxicant-REF	

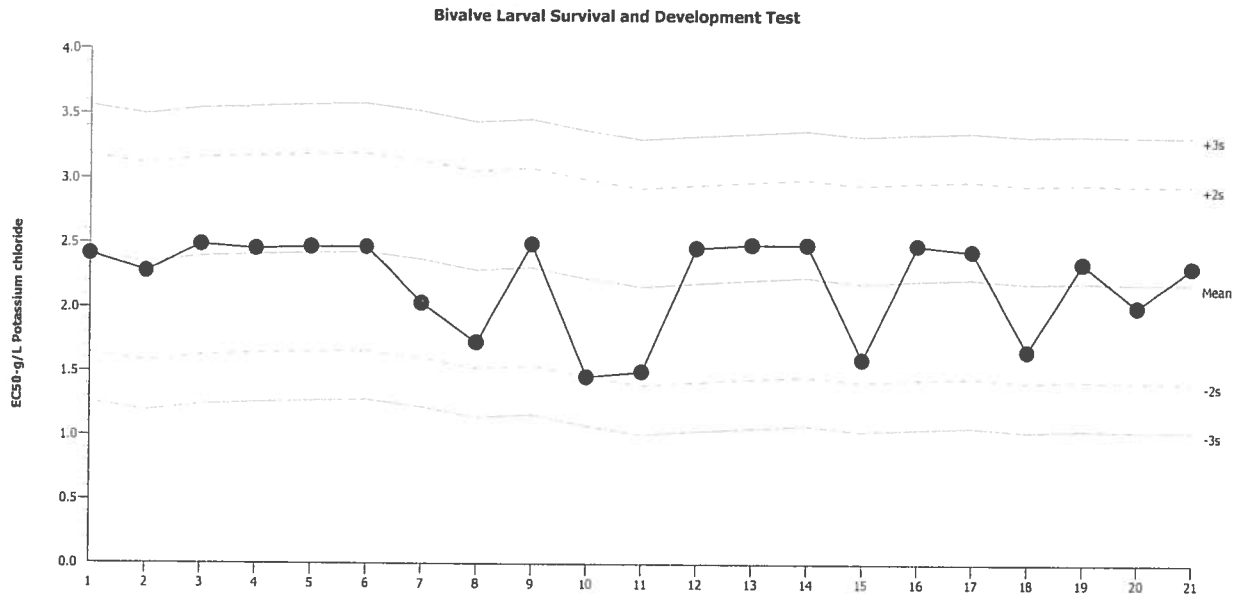

Mean: 2.19 **Count:** 20 **-2s Warning Limit:** 1.422 **-3s Action Limit:** 1.038
Sigma: 0.3839 **CV:** 17.50% **+2s Warning Limit:** 2.958 **+3s Action Limit:** 3.342

Quality Control Data

Point	Year	Month	Day	Time	QC Data	Delta	Sigma	Warning	Action	Test ID	Analysis ID
1	2016	Nov	17	15:49	2.414	0.2237	0.5828			04-3556-8618	21-4328-4612
2		Dec	8	15:20	2.278	0.0878	0.2287			17-9738-0261	15-7346-2808
3			9	14:56	2.487	0.2971	0.7738			13-6321-3255	12-2250-1612
4			13	15:21	2.456	0.2656	0.6918			04-7072-3645	15-3981-7010
5	2017	Jan	12	15:00	2.471	0.281	0.7319			09-2603-9304	07-7109-9519
6			18	14:52	2.47	0.2798	0.7288			17-0026-4613	16-3623-1247
7			26	14:50	2.033	-0.1575	-0.4102			17-1049-5214	11-7679-7114
8		Feb	22	15:19	1.728	-0.4623	-1.204			00-8430-1417	12-9073-1130
9		Mar	8	15:07	2.494	0.3042	0.7925			20-9462-6779	09-1482-4194
10			29	14:59	1.462	-0.728	-1.896			05-4954-2020	16-9324-1659
11		Apr	13	17:20	1.503	-0.687	-1.79			09-7130-1446	03-0299-6790
12			18	16:05	2.466	0.2759	0.7186			05-8336-6015	01-0728-5928
13			26	13:58	2.493	0.3027	0.7884			01-9102-6287	17-0956-9265
14		May	6	18:00	2.492	0.3018	0.7862			03-8327-4046	12-3154-8017
15			9	15:04	1.599	-0.5907	-1.539			00-6511-6942	19-4725-2359
16			19	16:00	2.487	0.2971	0.7739			17-8813-8283	08-8256-6714
17			24	15:00	2.445	0.255	0.6642			07-3625-6438	06-9626-2037
18		Jun	7	15:15	1.666	-0.5242	-1.366			20-2315-0237	05-3400-3742
19			14	14:35	2.35	0.1597	0.416			14-5549-8863	10-1080-9560
20		Jul	13	16:08	2.012	-0.1781	-0.4638			11-3301-3702	06-3042-2489
21		Aug	3	14:21	2.317	0.1271	0.3311			05-6483-9921	21-1149-5788

Mytilus sp. Development Toxicity Test Water Chemistry Data

Client: Reference Toxicant
 Test Material: Potassium Chloride
 Test ID#: 73966 Project #: 27742
 Test Date: 8/3/17

Organism Log#: 10280 Age: N/A
 Organism Supplier: M-Rep
 Control/Diluent: FSW @ 30±2 ppt

Day 0					
Treatment (g/L)	Temperature (°C)	pH	D.O. (mg/L)	Salinity (ppt)	Signoff
Lab Water Control	18.9	7.78	7.4	29.8	Ref Tox Stock # -
0.5	18.9	7.83	7.6	30.7	Test Solution Prep: <u>WC</u>
1	18.9	7.84	7.7	31.2	New WQ: <u>SE</u>
2	18.9	7.84	7.7	32.2	Innoculation Date: <u>8/3/17</u>
3	18.9	7.83	7.7	33.2	Innoculation Time: <u>1421</u>
4	18.9	7.82	7.7	34.2	Innoculation Signoff: <u>CO</u>
Meter ID	69A	PH23	RD12	EC10	

Day 1					
Treatment	Temperature (°C)	pH	D.O. (mg/L)	Salinity (ppt)	Signoff
Lab Water Control	18.8				Date: <u>8/4/17</u>
0.5	18.8				Old WQ: <u>CO</u>
1	18.8				
2	18.8				
3	18.8				
4	18.8				
Meter ID	69A				

Day 2					
Treatment	Temperature (°C)	pH	D.O. (mg/L)	Salinity (ppt)	Signoff
Lab Water Control	18.8	7.79	6.9	30.9	Termination Date: <u>8/5/17</u>
0.5	18.8	7.83	6.9	31.3	Termination Time: <u>1330</u>
1	18.8	7.83	7.0	31.9	Termination Signoff: <u>TK</u>
2	18.8	7.85	7.0	32.8	Old WQ: <u>CO</u>
3	18.8	7.86	7.0	33.9	
4	18.8	7.86	7.1	34.9	
Meter ID	69A	PH23	RD11	EC12	

Mytilus sp. Development Toxicity Test Count Data

Client: Reference Toxicant
 Test Material: Potassium Chloride
 Test ID #: 73966
 Project #: 27742

Test Start Date: 8/3/17
 Test End Date: ~~8/5/17~~ 8/5/17
 Enumeration Date: 8/7/17
 Investigator: LA

Concentration	Replicate	Number of Normal Larvae	Number of Abnormal Larvae	Total Number Larvae	Percent Normal Development
Lab Water Control	A	234	6	240	97.5
	B	232	5	237	97.9
	C	239	3	242 242	99.2 98.8
	D	226	2	228	99.1
0.5	A	259	4	263	98.5
	B	227	3	230	98.7
	C	261	6	267	97.8
	D	240	4	244	98.4
1	A	220	3	223	98.7
	B	215	9	224	96.0
	C	230	4	234	98.3
	D	239	1	240	99.6
2	A	153	34	187	81.8
	B	155	65	220	70.5
	C	155	74	229	67.7
	D	151	66	217	69.6
3	A	0	216	216	0.0
	B	0	224	224	0.0
	C	0	220	220	0.0
	D	0	210	210	0.0
4	A	0	0	0	0.0
	B	0	0	0	0.0
	C	0	0	0	0.0
	D	0	0	0	0.0

Appendix F

Test Data and Summary of Statistics for the Evaluation of the Chronic Toxicity of Crescent City Effluent to *Atherinops affinis*

CETIS Summary Report

Report Date: 16 Aug-17 10:45 (p 1 of 1)
 Test Code: 73744 | 14-8817-8128

Chronic Larval Fish Survival and Growth Test Pacific EcoRisk

Batch ID: 09-2254-7510	Test Type: Growth-Survival (7d)	Analyst: Stevi Vasquez
Start Date: 03 Aug-17 14:42	Protocol: EPA/600/R-95/136 (1995)	Diluent: Not Applicable
Ending Date: 10 Aug-17 08:15	Species: Atherinops affinis	Brine: Not Applicable
Duration: 6d 18h	Source: Aquatic Biosystems, CO	Age: 13

Sample ID: 20-0485-3657	Code: Effluent	Client: Crescent City
Sample Date: 02 Aug-17 13:22	Material: Effluent	Project: 27678
Receipt Date: 03 Aug-17 10:20	Source: City of Crescent City	
Sample Age: 25h (0.8 °C)	Station: Effluent Grab	

Single Comparison Summary

Analysis ID	Endpoint	Comparison Method	P-Value	Comparison Result
02-0818-1963	7d Survival Rate	TST-Welch's t Test	<0.25	3.45% passed 7d survival rate
03-5067-2087	Mean Dry Biomass-mg	TST-Welch's t Test	0.0112	3.45% passed mean dry biomass-mg

7d Survival Rate Summary

Conc-%	Code	Count	Mean	95% LCL	95% UCL	Min	Max	Std Err	Std Dev	CV%	%Effect
0	LW	5	1.000	1.000	1.000	1.000	1.000	0.000	0.000	0.00%	0.00%
3.45		5	1.000	1.000	1.000	1.000	1.000	0.000	0.000	0.00%	0.00%

Mean Dry Biomass-mg Summary

Conc-%	Code	Count	Mean	95% LCL	95% UCL	Min	Max	Std Err	Std Dev	CV%	%Effect
0	LW	5	1.71	1.54	1.88	1.6	1.95	0.0612	0.137	8.01%	0.00%
3.45		5	1.57	1.34	1.8	1.31	1.81	0.0821	0.183	11.69%	8.21%

7d Survival Rate Detail

Conc-%	Code	Rep 1	Rep 2	Rep 3	Rep 4	Rep 5
0	LW	1.000	1.000	1.000	1.000	1.000
3.45		1.000	1.000	1.000	1.000	1.000

Mean Dry Biomass-mg Detail

Conc-%	Code	Rep 1	Rep 2	Rep 3	Rep 4	Rep 5
0	LW	1.69	1.95	1.66	1.66	1.6
3.45		1.81	1.58	1.65	1.31	1.5

7d Survival Rate Binomials

Conc-%	Code	Rep 1	Rep 2	Rep 3	Rep 4	Rep 5
0	LW	5/5	5/5	5/5	5/5	5/5
3.45		5/5	5/5	5/5	5/5	5/5

CETIS Analytical Report

Report Date: 16 Aug-17 10:44 (p 1 of 2)
 Test Code: 73744 | 14-8817-8128

Chronic Larval Fish Survival and Growth Test Pacific EcoRisk

Analysis ID: 02-0818-1963 Endpoint: 7d Survival Rate CETIS Version: CETISv1.9.2
 Analyzed: 16 Aug-17 10:44 Analysis: Parametric Bioequivalence-Two Sample Official Results: Yes

Data Transform	Alt Hyp	TST_b	Comparison Result
Angular (Corrected)	C*b < T	0.75	3.45% passed 7d survival rate

TST-Welch's t Test

Control	vs	Control II	Test Stat	Critical	P-Type	P-Value	Decision(α:25%)
Lab Water Contr		3.45*	0.336	n/a		<0.25	Non-Significant Effect

ANOVA Table

Source	Sum Squares	Mean Square	DF	F Stat	P-Value	Decision(α:5%)
Between	0	0	1	65500	<1.0E-37	Significant Effect
Error	0	0	8			
Total	0		9			

7d Survival Rate Summary

Conc-%	Code	Count	Mean	95% LCL	95% UCL	Median	Min	Max	Std Err	CV%	%Effect
0	LW	5	1.000	1.000	1.000	1.000	1.000	1.000	0.000	0.00%	0.00%
3.45		5	1.000	1.000	1.000	1.000	1.000	1.000	0.000	0.00%	0.00%

Angular (Corrected) Transformed Summary

Conc-%	Code	Count	Mean	95% LCL	95% UCL	Median	Min	Max	Std Err	CV%	%Effect
0	LW	5	1.35	1.35	1.35	1.35	1.35	1.35	0	0.00%	0.00%
3.45		5	1.35	1.35	1.35	1.35	1.35	1.35	0	0.00%	0.00%

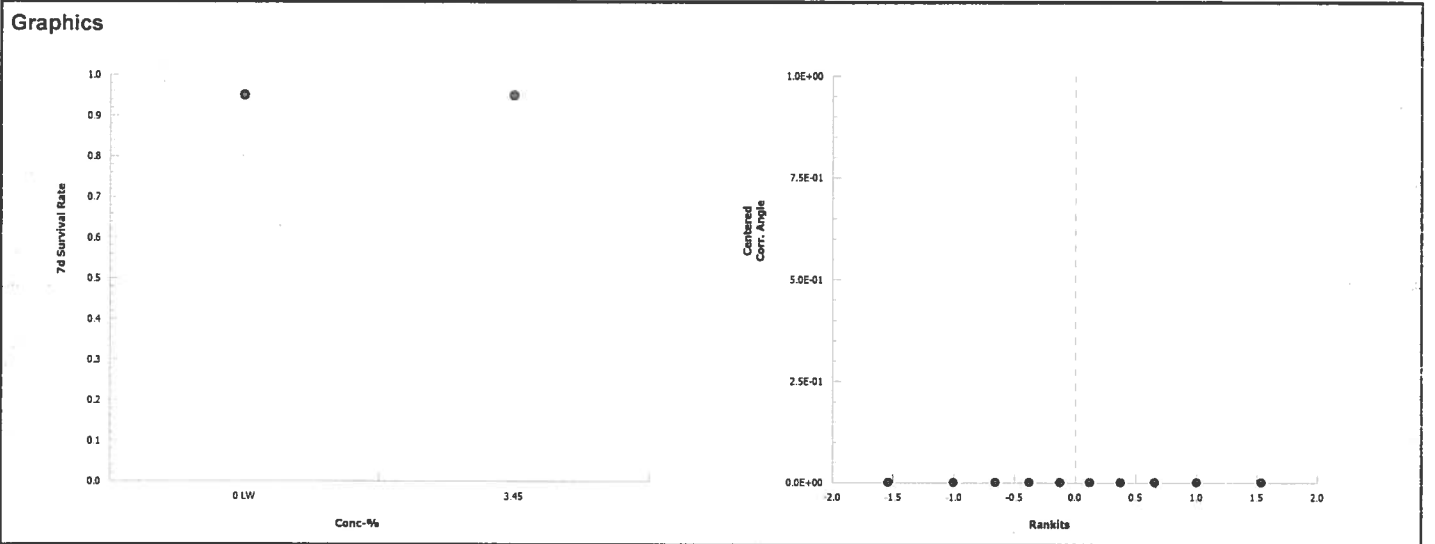

CETIS Analytical Report

Report Date: 16 Aug-17 10:44 (p 2 of 2)
 Test Code: 73744 | 14-8817-8128

Chronic Larval Fish Survival and Growth Test Pacific EcoRisk

Analysis ID: 03-5067-2087 Endpoint: Mean Dry Biomass-mg CETIS Version: CETISv1.9.2
 Analyzed: 16 Aug-17 10:44 Analysis: Parametric Bioequivalence-Two Sample Official Results: Yes

Data Transform	Alt Hyp	TST_b	Comparison Result
Untransformed	C*b < T	0.75	3.45% passed mean dry biomass-mg

TST-Welch's t Test

Control	vs	Control II	Test Stat	Critical	DF	P-Type	P-Value	Decision(α:25%)
Lab Water Contr		3.45*	3.05	0.718	6	CDF	0.0112	Non-Significant Effect

ANOVA Table

Source	Sum Squares	Mean Square	DF	F Stat	P-Value	Decision(α:5%)
Between	0.0492815	0.0492815	1	1.88	0.2075	Non-Significant Effect
Error	0.209619	0.0262024	8			
Total	0.2589		9			

Distributional Tests

Attribute	Test	Test Stat	Critical	P-Value	Decision(α:1%)
Variances	Variance Ratio F Test	1.8	23.2	0.5841	Equal Variances
Distribution	Shapiro-Wilk W Normality Test	0.924	0.741	0.3927	Normal Distribution

Mean Dry Biomass-mg Summary

Conc-%	Code	Count	Mean	95% LCL	95% UCL	Median	Min	Max	Std Err	CV%	%Effect
0	LW	5	1.71	1.54	1.88	1.66	1.6	1.95	0.0612	8.01%	0.00%
3.45		5	1.57	1.34	1.8	1.58	1.31	1.81	0.0821	11.69%	8.21%

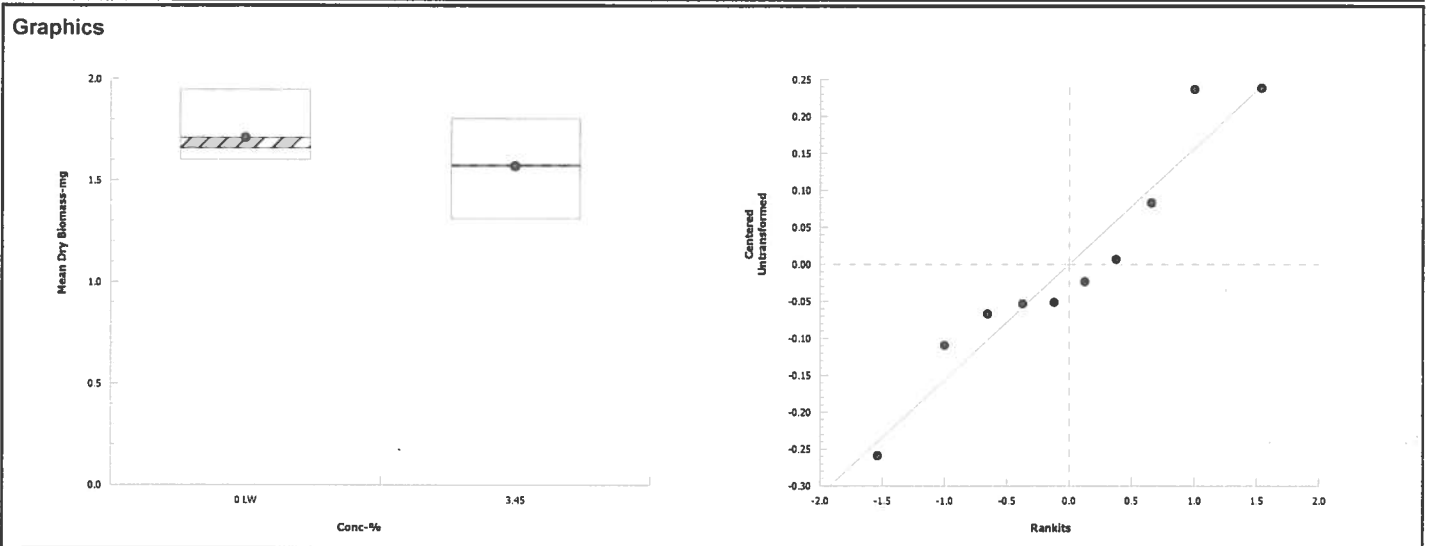

7 Day Chronic Topsmelt (*A. affinis*) Toxicity Test Data

Client: Crescent City

Organism Log#: 10438 Age: 13 days

Test Material: Effluent Test Date: 8/13/17

Organism Supplier: ABS

Test ID#: 73744 Project #: 27678

Control Water: Filtered Seawater

5.2.1

Test Treatment	Temp (C)	pH		D.O. (mg/L)		Salinity (ppt)	# Live Organisms					SIGN-OFF
		new	old	new	old		A	B	C	D	E	
Lab Control	20.0	7.42		8.6		32.6	5	5	5	5	5	Date: 8-3-17 Test Solution Prep: SMC
3.45%	20.0	7.50		8.2		31.6 30.9 SMC 8/3/17	5	5	5	5	5	Initiation Time: 1442 Initiation Signoff: RG
Meter ID	100A	PH21		RD11		EC11	New WQ: SMC					Sample ID: 47106
Lab Control	20.7	7.72	7.72	9.7	6.9	32.1	5	5	5	5	5	Date: 8-4-17 Test Solution Prep: SMC
3.45%	20.6	7.72	7.76	9.6	6.9	31.6	5	5	5	5	5	Renewal Time: 1110 Renewal Signoff: CD
Meter ID	100A	PH23	PH23	RD11	RD11	EC08	New WQ: W	Old WQ: TK				Sample ID: 47106
Lab Control	20.7	7.62	7.65	8.1	6.7	32.2	5	5	5	5	5	Date: 8/5/17 Test Solution Prep: TK
3.45%	20.5	7.62	7.64	8.0	6.5	31.7	5	5	5	5	5	Renewal Time: 1120 Renewal Signoff: SD
Meter ID	81A	PH19	PH19	RD00	RD10	EC08	New WQ: W	Old WQ: W				Sample ID: 47122
Lab Control	20.9	7.48	7.68	9.6	6.6	32.4	5	5	5	5	5	Date: 8/6/17 Test Solution Prep: W
3.45%	20.6	7.58	7.71	9.6	6.7	31.5	5	5	5	5	5	Renewal Time: 1230 Renewal Signoff: W
Meter ID	103A	PH21	PH19	RD10	RD12	EC10	New WQ: SH	Old WQ: BV				Sample ID: 47122
Lab Control	20.6	7.65	7.71	11.0	7.2	32.5	5	5	5	5	5	Date: 8/7/17 Test Solution Prep: SH
3.45%	20.2	7.67	7.73	10.8	7.1	31.7	5	5	5	5	5	Renewal Time: 0945 Renewal Signoff: SH
Meter ID	31A	PH21	PH23	RD12	RD10	EC10	New WQ: SH	Old WQ:				Sample ID: 47122
Lab Control	20.5	7.48	7.70	8.5	6.6	32.1	5	5	5	5	5	Date: 8/8/17 Test Solution Prep: JL
3.45%	20.5	7.63	7.73	8.6	6.7	31.5	5	5	5	5	5	Renewal Time: 1015 Renewal Signoff: W
Meter ID	31A	PH21	PH21	RD10	RD10	EC11	New WQ: LA	Old WQ: LA				Sample ID: 47149
Lab Control	20.5	7.79	7.36	8.6	6.6	32.1	5	5	5	5	5	Date: 8/9/17 Test Solution Prep: SMC
3.45%	20.2	7.80	7.36	8.8	6.5	31.4	5	5	5	5	5	Renewal Time: 1050 Renewal Signoff: JL
Meter ID	100A	PH23	PH15	RD11	RD10	EC08	New WQ: MS	Old WQ: HA				Sample ID: 47149
Lab Control	20.4		7.49		6.8	33.8	5	5	5	5	5	Date: 8/10/17 Termination Time: 0815
3.45%	20.1		7.52		6.7	34.0	5	5	5	5	5	Termination Signoff: SH
Meter ID	31A		PH21		RD11	EC12		Old WQ: SD				

7 Day Chronic Topsmelt (*A. affinis*) Test Data

Client: Crescent City Test ID #: 73744 Project # 27678
 Sample: Effluent Tare Weight Date: 8/6/17 Sign-off: SSB
 Test Date: 8/31/17 Final Weight Date: 8/14/17 Sign-off: CR

Pan ID	Concentration	Replicate	Initial Pan Weight (mg)	Final Pan Weight (mg)	Initial # of Organisms	Biomass Value (mg)
1	Control	A	412.52	420.95	5	1.69
2		B	413.02	422.76	5	1.95
3		C	416.24	424.53	5	1.66
4		D	417.84	426.12	5	1.66
5		E	412.11	420.11	5	1.60
6	Brine Control	A	414.90	-	-	-
7		B	409.67	-	-	-
8		C	417.52	-	-	-
9		D	413.87	-	-	-
10		E	415.65	-	-	-
11	3.45%	A	407.68	416.71	5	1.81
12		B	409.38	417.26	5	1.58
13		C	412.52	420.78	5	1.65
14		D	412.35	418.90	5	1.31
15		E	415.33	422.84	5	1.50
QA 1			415.29	415.33		
QA 2			416.74	416.69		
Balance ID			BAL04	BAL04		

Appendix G

Test Data and Summary of Statistics for the Reference Toxicant Evaluation of the *Atherinops affinis*

CETIS Summary Report

Report Date: 23 Aug-17 10:08 (p 1 of 2)
 Test Code: 73967 | 20-6811-8584

Chronic Larval Fish Survival and Growth Test				Pacific EcoRisk
Batch ID: 17-9711-0355	Test Type: Growth-Survival (7d)	Analyst: Stevi Vasquez		
Start Date: 03 Aug-17 15:00	Protocol: EPA/600/R-95/136 (1995)	Diluent: Filtered Seawater		
Ending Date: 10 Aug-17 09:00	Species: Atherinops affinis	Brine: Not Applicable		
Duration: 6d 18h	Source: Aquatic Biosystems, CO	Age: 13		
Sample ID: 02-1425-6185	Code: CuCl2	Client: Pacific Ecorisk		
Sample Date: 03 Aug-17 15:00	Material: Copper chloride	Project: 27743		
Receipt Date: 03 Aug-17 15:00	Source: Reference Toxicant			
Sample Age: n/a (19.7 °C)	Station: In House			

Multiple Comparison Summary							
Analysis ID	Endpoint	Comparison Method	NOEL	LOEL	TOEL	TU	PMSD ✓
18-3376-2604	7d Survival Rate	Dunnett Multiple Comparison Test	100	180	134.2		24.7%
09-4619-2531	Mean Dry Biomass-mg	Dunnett Multiple Comparison Test	100	> 100	n/a		37.8%

Point Estimate Summary							
Analysis ID	Endpoint	Point Estimate Method	Level	µg/L	95% LCL	95% UCL	TU ✓
03-9822-6188	7d Survival Rate	Regression: Log-Normal (Probit)	EC5	90.6	47.2	117	
			EC10	102	59.1	128	
			EC15	111	68.6	136	
			EC20	119	77.2	143	
			EC25	125	85.3	150	
			EC40	144	109	169	
			EC50	157	124	184	
15-9739-7007	Mean Dry Biomass-mg	Linear Interpolation (ICPIN)	IC5	89.1	n/a	115	
			IC10	104	14.7	118	
			IC15	111	45.5	125	
			IC20	117	59.2	131	
			IC25	123	68.3	138	
			IC40	143	98.9	159	
			IC50	155	123	173	

7d Survival Rate Summary											
Conc-µg/L	Code	Count	Mean	95% LCL	95% UCL	Min	Max	Std Err	Std Dev	CV%	%Effect
0	LW	5	0.960	0.849	1.000	0.800	1.000	0.040	0.089	9.32%	0.00%
56		5	0.880	0.744	1.000	0.800	1.000	0.049	0.110	12.45%	8.33%
100		5	0.800	0.449	1.000	0.400	1.000	0.126	0.283	35.36%	16.67%
180		5	0.360	0.152	0.568	0.200	0.600	0.075	0.167	46.48%	62.50%
320		5	0.000	0.000	0.000	0.000	0.000	0.000	0.000		100.00%
560		5	0.000	0.000	0.000	0.000	0.000	0.000	0.000		100.00%
1000		5	0.000	0.000	0.000	0.000	0.000	0.000	0.000		100.00%

Mean Dry Biomass-mg Summary											
Conc-µg/L	Code	Count	Mean	95% LCL	95% UCL	Min	Max	Std Err	Std Dev	CV%	%Effect
0	LW	5	1.57	1.35	1.8	1.29	1.74	0.081	0.181	11.49%	0.00%
56		5	1.71	1.3	2.12	1.18	1.97	0.148	0.33	19.26%	-8.74%
100		5	1.53	0.696	2.37	0.754	2.35	0.302	0.676	44.03%	2.57%
180		5	0.505	0.193	0.817	0.26	0.888	0.112	0.251	49.78%	67.95%
320		5	0	0	0	0	0	0	0		100.00%
560		5	0	0	0	0	0	0	0		100.00%
1000		5	0	0	0	0	0	0	0		100.00%

CETIS Summary Report

Report Date: 23 Aug-17 10:08 (p 2 of 2)
 Test Code: 73967 | 20-6811-8584

Chronic Larval Fish Survival and Growth Test							Pacific EcoRisk
7d Survival Rate Detail							
Conc-µg/L	Code	Rep 1	Rep 2	Rep 3	Rep 4	Rep 5	
0	LW	1.000	0.800	1.000	1.000	1.000	
56		0.800	1.000	0.800	0.800	1.000	
100		0.400	0.600	1.000	1.000	1.000	
180		0.200	0.400	0.200	0.400	0.600	
320		0.000	0.000	0.000	0.000	0.000	
560		0.000	0.000	0.000	0.000	0.000	
1000		0.000	0.000	0.000	0.000	0.000	
Mean Dry Biomass-mg Detail							
Conc-µg/L	Code	Rep 1	Rep 2	Rep 3	Rep 4	Rep 5	
0	LW	1.51	1.29	1.64	1.69	1.74	
56		1.64	1.8	1.18	1.97	1.97	
100		0.924	0.754	2.35	1.73	1.92	
180		0.308	0.586	0.26	0.482	0.888	
320		0	0	0	0	0	
560		0	0	0	0	0	
1000		0	0	0	0	0	
7d Survival Rate Binomials							
Conc-µg/L	Code	Rep 1	Rep 2	Rep 3	Rep 4	Rep 5	
0	LW	5/5	4/5	5/5	5/5	5/5	
56		4/5	5/5	4/5	4/5	5/5	
100		2/5	3/5	5/5	5/5	5/5	
180		1/5	2/5	1/5	2/5	3/5	
320		0/5	0/5	0/5	0/5	0/5	
560		0/5	0/5	0/5	0/5	0/5	
1000		0/5	0/5	0/5	0/5	0/5	

Chronic Larval Fish Survival and Growth Test

Pacific EcoRisk

Test Type: Growth-Survival (7d)

Organism: Atherinops affinis (Topsmelt)

Material: Copper chloride

Protocol: EPA/600/R-95/136 (1995)

Endpoint: 7d Survival Rate

Source: Reference Toxicant-REF

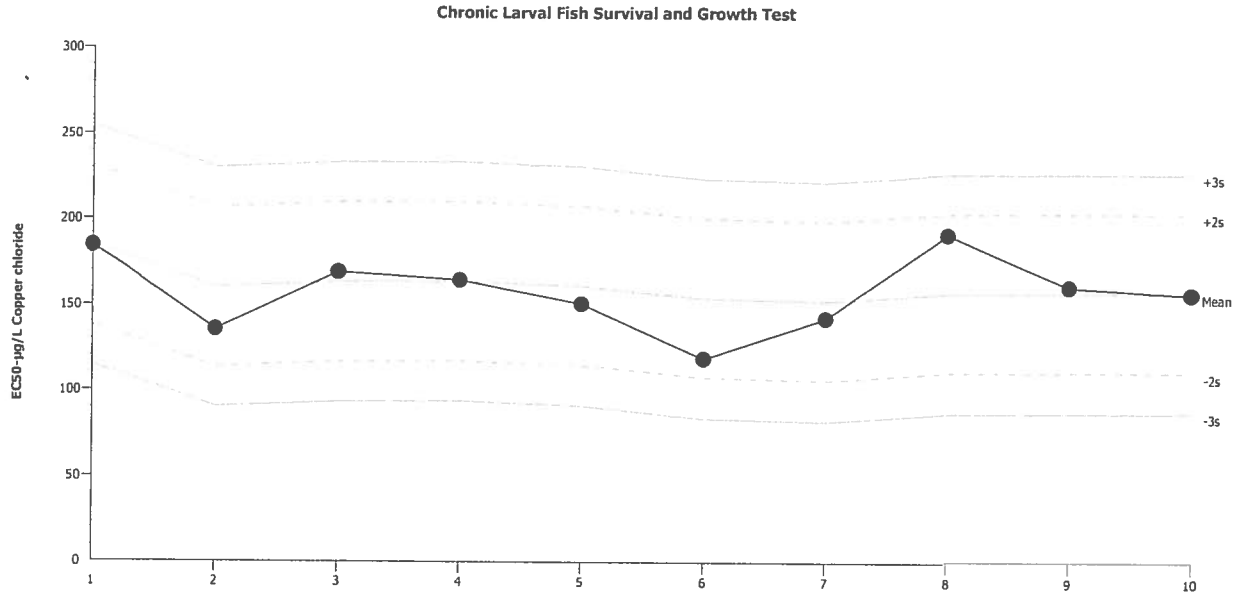

Mean: 157.6 Count: 9 -2s Warning Limit: 111 -3s Action Limit: 87.64
 Sigma: 23.31 CV: 14.80% +2s Warning Limit: 204.2 +3s Action Limit: 227.5

Quality Control Data

Point	Year	Month	Day	Time	QC Data	Delta	Sigma	Warning	Action	Test ID	Analysis ID
1	2016	Dec	1	14:45	184.5	26.91	1.154			09-7939-5083	05-4673-5824
2	2017	Jan	2	12:00	135.5	-22.07	-0.9468			12-4511-7385	16-4079-6039
3			2	13:00	169	11.37	0.4879			18-4696-7845	15-3506-1739
4		Mar	21	13:30	164.3	6.692	0.2871			14-7502-6999	21-3878-4314
5			21	14:30	150.6	-6.991	-0.2999			20-6326-4170	01-2850-5128
6		Apr	27	15:20	118.8	-38.79	-1.664			12-5173-5100	18-2281-7403
7		May	6	15:10	142.4	-15.2	-0.6519			00-9957-1385	04-8504-7742
8		Jun	13	14:20	191.7	34.1	1.463			00-7889-2529	02-3682-4376
9		Jul	13	14:35	161.3	3.72	0.1596			17-8123-4418	08-8465-2146
10		Aug	3	15:00	157	-0.6131	-0.0263			20-6811-8584	03-9822-6188

Chronic Larval Fish Survival and Growth Test		Pacific EcoRisk	
Test Type: Growth-Survival (7d)	Organism: Atherinops affinis (Topsmelt)	Material: Copper chloride	
Protocol: EPA/600/R-95/136 (1995)	Endpoint: Mean Dry Biomass-mg	Source: Reference Toxicant-REF	

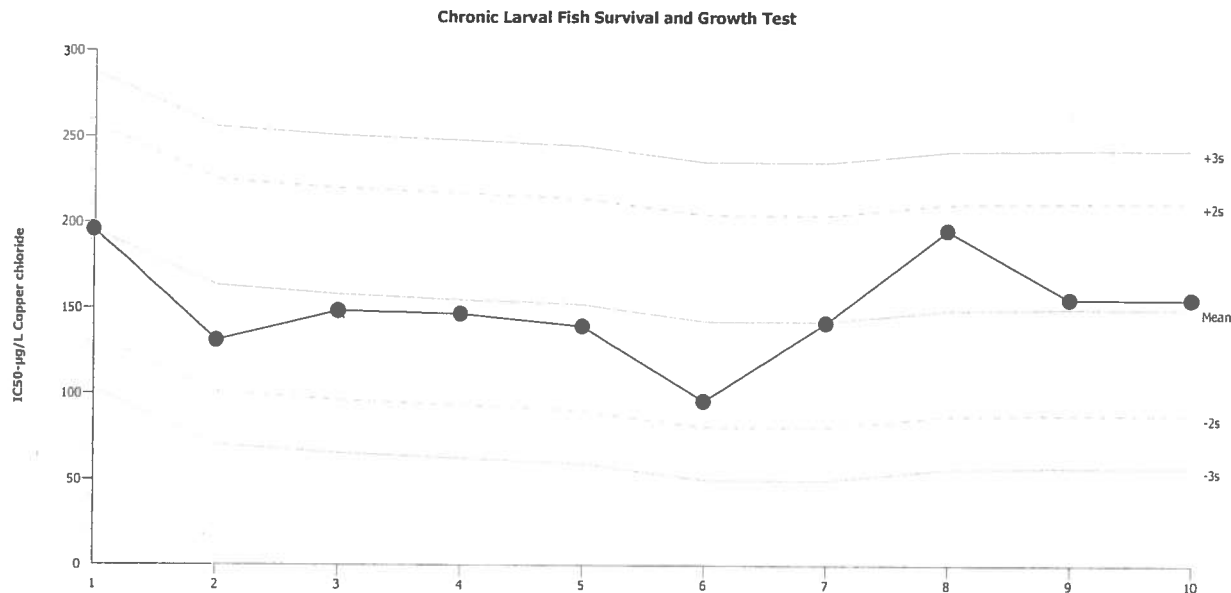

Mean: 149.9 **Count:** 9 **-2s Warning Limit:** 88.11 **-3s Action Limit:** 57.2
Sigma: 30.91 **CV:** 20.60% **+2s Warning Limit:** 211.7 **+3s Action Limit:** 242.7

Quality Control Data

Point	Year	Month	Day	Time	QC Data	Delta	Sigma	Warning	Action	Test ID	Analysis ID
1	2016	Dec	1	14:45	195.3	45.45	1.47			09-7939-5083	07-5754-6003
2	2017	Jan	2	12:00	131.1	-18.82	-0.6088			12-4511-7385	15-6656-2716
3			2	13:00	148.3	-1.596	-0.05164			18-4696-7845	01-2015-2482
4		Mar	21	13:30	146.7	-3.235	-0.1047			14-7502-6999	08-0647-8893
5			21	14:30	139.4	-10.47	-0.3388			20-6326-4170	03-3854-1324
6		Apr	27	15:20	95.92	-53.98	-1.746			12-5173-5100	15-1911-6681
7		May	6	15:10	141.6	-8.329	-0.2695			00-9957-1385	17-5803-8095
8		Jun	13	14:20	195.6	45.68	1.478			00-7889-2529	14-9330-6229
9		Jul	13	14:35	155.5	5.57	0.1802			17-8123-4418	15-5385-4800
10		Aug	3	15:00	155.4	5.469	0.1769			20-6811-8584	15-9739-7007

7 Day Chronic Topsmelt Reference Toxicant Test Data

Client: Reference Toxicant
 Test Material: Copper Chloride
 Test ID#: 73967 Project #: 27743
 Test Date: 8/3/17 Randomization: S.T.2

Organism Log#: 10438 Age: 13d
 Organism Supplier: ABS
 Control/Diluent: FSW
 Control Water Batch: -

Treatment (µg/L CuCl ₂)	Temp (°C)	pH		D.O. (mg/L)		Salinity (ppt)		# Live Organisms					SIGN-OFF
		new	old	new	old	new	old	A	B	C	D	E	
Control	19.7	7.50		7.7		32.1		5	5	5	5	5	Date: 8/3/17
56	19.7	7.64		8.6		32.3		5	5	5	5	5	RT Stock Batch # 2
100	19.8	7.64		8.5		32.5		5	5	5	5	5	Test Solution Prep TK
180	19.8	7.65		8.7		32.3		5	5	5	5	5	New WQ: KG
320	19.8	7.59		8.4		32.1		5	5	5	5	5	Initiation Time: 1500
560	19.7	7.53		8.0		32.3		5	5	5	5	5	Initiation Signoff: TK
1000	19.8	7.51		8.0		32.1		5	5	5	5	5	
Meter ID:	103A	PH23		RD12		EC10							
Control	20.8	7.78	7.76	8.6	6.5	32.3	32.8	5	5	5	5	5	Date: 8/4/17
56	20.7	7.79	7.79	8.5	6.6	32.6	32.9	5	5	5	5	5	RT Stock Batch # 3
100	20.6	7.79	7.80	8.4	6.6	32.5	33.0	4	5	5	5	5	Test Solution Prep TK
180	20.7	7.79	7.80	8.4	6.6	32.4	33.0	5	4	4	5	5	New WQ: SMC
320	21.0	7.78	7.81	8.3	6.7	32.5	32.8	0	3	2	3	3	Renewal Time: 1255
560	21.0	7.78	7.76	8.2	6.7	32.3	32.8	0	0	0	0	0	Renewal Sign-off: ARF
1000	20.9	7.77	7.77	8.3	6.5	32.3	32.5	0	0	0	0	0	Old WQ: TK
Meter ID:	100A	PH23	PH23	RD11	RD11	EC08	EC08						
Control	20.6	7.11	7.80	9.2	6.8	32.9	33.1	5	4	5	5	5	Date: 8/5/17
56	20.6	7.22	7.77	8.8	6.7	33.2	33.6	5	5	4	5	5	RT Stock Batch # 3
100	20.5	7.29	7.58	8.6	6.7	33.2	33.6	4	5	5	5	5	Test Solution Prep RB
180	20.5	7.36	7.44	8.5	6.6	33.1	33.6	5	2	3	4	5	New WQ: YJ
320	20.6	7.44	7.41	8.8	6.5	33.0	33.2	-	3	1	2	1	Renewal Time: 1514
560	-	-	-	-	-	-	-	-	-	-	-	-	Renewal Sign-off: RB
1000	-	-	-	-	-	-	-	-	-	-	-	-	Old WQ: TK
Meter ID:	100A	PH21	PH21	RD11	RD11	EC12	EC12						
Control	20.9	7.56	7.54	9.8	6.4	32.8	32.8	5	4	5	5	5	Date: 8/6/17
56	20.7	7.63	7.63	9.7	6.5	33.0	33.2	5	5	4	5	5	RT Stock Batch # 3
100	20.8	7.67	7.64	9.7	6.4	32.9	33.3	4	5	5	5	5	Test Solution Prep WC
180	20.8	7.69	7.68	9.8	6.4	32.9	33.0	5	2	3	3	4	New WQ: SH
320	20.8	7.71	7.71	9.8	6.1	32.9	32.9	-	1	1	2	1	Renewal Time: 1110
560	-	-	-	-	-	-	-	-	-	-	-	-	Renewal Sign-off: SH
1000	-	-	-	-	-	-	-	-	-	-	-	-	Old WQ: KL
Meter ID:	100A	PH21	PH21	RD10	RD10	EC10	EC10						

7 Day Chronic Topsmelt Reference Toxicant Test Data

Client: Reference Toxicant Organism Log#: 10438 Age: 13d
 Test Material: Copper Chloride Organism Supplier: ABS
 Test ID#: 73967 Project #: 27743 Control/Diluent: FSW
 Test Date: 8/13/17 Randomization: S.T.2 Control Water Batch: -

Treatment (µg/L CuCl ₂)	Temp (°C)	pH		D.O. (mg/L)		Salinity (ppt)		# Live Organisms					SIGN-OFF
		new	old	new	old	new	old	A	B	C	D	E	
Control	20.5	7.62	7.70	9.6	6.6	33.2	33.0	5	4	5	5	5	Date: 8/17/17
56	20.5	7.59	7.72	9.4	6.7	33.2	33.1	5	5	4	4	5	RT Stock Batch # 3
100	20.4	7.58	7.74	9.4	6.8	33.1	33.5	3	5	5	5	5	Test Solution Prep TK
180	20.4	7.57	7.74	9.3	6.9	33.2	33.4	2	2	3	2	4	New WQ SH
320	20.5	7.58	7.75	9.4	6.9	33.0	33.3	-	0	1	2	1	Renewal Time 1045
560	-	-	-	-	-	-	-	-	-	-	-	-	Renewal-Sign-off TK
1000	-	-	-	-	-	-	-	-	-	-	-	-	Old WQ SH
Meter ID:	81A	PH21	PH21	RD12	RD10	EC10	EC12						
Control	20.3	7.79	7.53	9.1	7.9	32.0	33.0	5	4	5	5	5	Date 8/8/17
56	20.5	7.81	7.62	9.0	8.1	32.4	33.3	4	5	4	4	5	RT Stock Batch # 3
100	20.5	7.84	7.68	8.9	8.1	32.3	33.5	3	4	5	5	5	Test Solution Prep SD
180	20.6	7.84	7.74	9.0	8.2	32.6	33.5	1	2	2	2	3	New WQ IA
320	20.7	7.85	7.77	8.9	8.2	32.5	33.1	-	-	0	1	0	Renewal Time 1000
560	-	-	-	-	-	-	-	-	-	-	-	-	Renewal-Sign-off SH
1000	-	-	-	-	-	-	-	-	-	-	-	-	Old WQ IA
Meter ID:	31A	PH21	PH21	RD10	RD10	EC11	EC11						
Control	20.4	7.85	7.59	9.0	6.4	32.0	31.8	5	4	5	5	5	Date 8/9/17
56	20.5	7.85	7.51	9.1	6.0	32.2	32.7	4	5	4	4	5	RT Stock Batch # 3
100	20.4	7.85	7.61	8.9	6.3	32.2	32.5	2	3	5	5	5	Test Solution Prep SH
180	20.5	7.86	7.62	9.1	6.5	32.3	32.5	1	2	1	2	3	New WQ MB
320	20.5	7.85	7.52	9.2	6.0	32.4	33.0	-	-	-	0	-	Renewal Time 1335
560	-	-	-	-	-	-	-	-	-	-	-	-	Renewal-Sign-off JBL
1000	-	-	-	-	-	-	-	-	-	-	-	-	Old WQ IA
Meter ID:	31A	PH23	PH23	RD11	RD11	EC08	EC08						
Control	20.5		7.35		6.5		33.1	5	4	5	5	5	Date 8/16/17
56	20.5		7.42		6.6		33.5	4	5	4	4	5	Termination Time 0900
100	20.4		7.51		6.6		33.5	2	3	5	5	5	Termination Sign-off TK
180	20.4		7.60		6.7		33.6	1	2	1	2	3	Old WQ SD
320	20.5		-		-		-	-	-	-	-	-	
560	-		-		-		-	-	-	-	-	-	
1000	-		-		-		-	-	-	-	-	-	
Meter ID:	81A		PH21		RD11		EC12						

Topsmelt Dry Weight Data Sheet

Client: <u>Reference Toxicant</u>	Test ID #: <u>73967</u>	Project #: <u>27743</u>
Sample: <u>CuCl</u>	Tare Weight Date: <u>8/6/17</u>	Sign-off: <u>SJB</u>
Test Date: <u>8/3/17</u>	Final Weight Date: <u>8/14/17</u>	Sign-off: <u>LZ</u>

Pan ID	Concentration	Replicate	Initial Pan Weight (mg)	Final Pan Weight (mg)	Initial # of Organisms	Biomass Value (mg)
1	Control	A	410.05	417.62	10 S	1.51
2		B	416.43	422.87	10 S	1.29
3		C	414.63	422.85	10 S	1.64
4		D	413.94	422.37	10 S	1.69
5		E	415.65	424.36	10 S	1.74
6	56	A	412.44	420.66	10 S	1.64
7		B	411.00	419.98	10 S	1.30
8		C	413.17	419.05	10 S	1.18
9		D	407.31	417.17	10 S	1.97
10		E	407.68	417.55	10 S	1.97
11	100	A	418.45	423.07	10 S	0.92
12		B	405.71	409.48	10 S	0.75
13		C	416.89	428.62	10 S	2.35
14		D	415.08	423.73	10 S	1.73
15		E	417.90	427.49	10 S	1.92
16	180	A	409.58	411.12	10 S	0.31
17		B	417.33	420.26	10 S	0.59
18		C	417.57	418.87	10 S	0.26
19		D	409.24	411.65	10 S	0.48
20		E	420.61	425.05	10 S	0.89
21	320	A	414.20	-	10 S	0
22		B	418.81	-	10 S	0
23		C	410.72	-	10 S	0
24		D	409.48	-	10 S	0
25		E	413.54	-	10 S	0
26	560	A	409.68	-	10 S	0
27		B	410.63	-	10 S	0
28		C	408.81	-	10 S	0
29		D	408.96	-	10 S	0
30		E	417.35	-	10 S	0
31	1000	A	417.00	-	10 S	0
32		B	413.26	-	10 S	0
33		C	419.58	-	10 S	0
34		D	414.20	-	10 S	0
35		E	414.80	-	10 S	0
QA1			409.94	409.99		0.01
QA2			410.46	410.44		0.00
QA3			408.79	408.73		0.01
Balance ID:			BAL04	BAL04		



Tara Wood
Crescent City Water Quality Control Laboratory
377 J Street
Crescent City, CA 95531

September 4, 2018

Tara:

I have enclosed our report “Chronic Toxicity Testing of Crescent City Wastewater Treatment Plant Effluent” for the effluent samples collected August 20, 22 and 24, 2018. The results of this test are summarized below.

Chronic Toxicity of Crescent City Effluent to *Atherinops affinis*

There was no reductions in survival or growth; the TST analysis resulted in a pass for both endpoints.

If you have any questions regarding this testing, please feel free to call my colleague Dr. Brant Jorgenson or myself at (707) 207-7760.

Regards,

Ashleigh Findley
Aquatic Ecotoxicologist



Pacific EcoRisk is accredited in accordance with NELAP (ORELAP ID 4043). Pacific EcoRisk certifies that the test results reported herein conform to the most current NELAP requirements for parameters for which accreditation is required and available. Any exceptions to NELAP requirements are noted, where applicable, in the body of the report. This report shall not be reproduced, except in full, without the written consent of Pacific EcoRisk. This testing was performed under Lab Order 29193.

Chronic Toxicity Testing of Crescent City Wastewater Treatment Plant Effluent

Sample collected August 20, 22, and 24, 2018

Performed For

City of Crescent City
Water Quality Control Laboratory
377 J Street
Crescent City, CA 95531-4025

Prepared By

Pacific EcoRisk, Inc.
2250 Cordelia Road
Fairfield, CA 94534

September 2018



Chronic Toxicity Testing of Crescent City Wastewater Treatment Plant Effluent

Sample collected August 20, 22, and 24, 2018

Table of Contents

	Page
1. INTRODUCTION	1
2. TOXICITY TEST PROCEDURES	1
2.1 Sample Receipt and Handling	1
2.2 Chronic Toxicity Testing with <i>Atherinops affinis</i>	1
2.3 Reference Toxicant Testing of the <i>Atherinops affinis</i>	2
3. TESTING RESULTS	3
3.1 Chronic Toxicity of Crescent City Effluent to <i>Atherinops affinis</i>	3
3.2 Reference Toxicant Toxicity to <i>Atherinops affinis</i>	3
4. SUMMARY AND CONCLUSIONS	4
4.1 QA/QC Summary	4

Appendices

Appendix A Chain-of-Custody Record for the Collection and Delivery of the Sample

Appendix B Test Data and Summary of Statistics for the Evaluation of the Chronic Toxicity of Crescent City Effluent to *Atherinops affinis*

Appendix C Test Data and Summary of Statistics for the Reference Toxicant Evaluation of the *Atherinops affinis*



1. INTRODUCTION

The City of Crescent City has contracted Pacific EcoRisk (PER) to perform an evaluation of the chronic toxicity of Crescent City Wastewater Treatment Plant (Crescent City) effluent. This evaluation consisted of performing the EPA chronic toxicity test with topsmelt (*Atherinops affinis*) using effluent samples that were collected on August 20, 22, 24, 2018. In order to assess the sensitivity of the test organisms to toxic stress, a reference toxicant test was also performed. This report describes the performance and results of these tests.

2. TOXICITY TEST PROCEDURES

The methods used in this testing followed the guidelines established by the EPA manual “Short-Term Methods for Measuring the Chronic Toxicity of Effluents and Receiving Waters to West Coast Marine and Estuarine Organisms” (EPA/600/R-95/136).

2.1 Sample Receipt and Handling

On August 20, 22, and 24, samples of Crescent City effluent were collected into appropriately cleaned sample containers and shipped via overnight delivery, on ice and under chain-of-custody, to the PER laboratory in Fairfield, CA. Upon receipt at the laboratory, aliquots of the samples were collected for analysis of initial water quality characteristics (Table 1), with the remainder of the samples being stored at $\leq 6^{\circ}\text{C}$, except when being used to prepare test solutions. The chain-of-custody record for the collection and delivery of this sample is presented in Appendix A.

Date Sample Received	Sample ID	Temp (°C)	pH	D.O (mg/L)	Salinity (ppt)	Conductivity (µS/cm)	Total Ammonia (mg/L N)
8/21/18	EFF-001	0.1	7.51	5.7	0.4	660	13.8
8/23/18	EFF-001	0.2	7.52	9.2	0.4	709	11.5
8/25/18	EFF-001	1.0	7.57	7.1	0.4	741	17.0

2.2 Chronic Toxicity Testing with *Atherinops affinis*

The chronic toxicity test with *Atherinops affinis* consists of exposing larval fish to the effluent for 7 days, after which effects on survival and growth are evaluated. The specific procedures used in this testing are described below.

The larval fish used in these tests were obtained from a commercial supplier (Aquatic Biosystems, Fort Collins, CO). Upon receipt at the testing lab, the larval fish were maintained in a tank containing aerated Lab Water Control medium. The fish were fed brine shrimp nauplii *ad libitum* during the pre-test holding period.



The Lab Water Control medium for these tests consisted of 0.2 µm filtered seawater (U.C. Granite Canyon Marine Laboratory, CA). The Lab Water Control medium and effluent were used to prepare test solutions at the test treatment concentration of 3.45% effluent. Routine water quality characteristics (pH, D.O., and salinity) were measured for each test solution prior to use in these tests.

There were five replicates for each test treatment, each replicate consisting of 200 mL of test solution in a 600-mL glass beaker. The tests were initiated by randomly allocating five 14-day old topsmelt into each replicate beaker. The beakers were randomly positioned in a temperature-controlled room at 20°C, under a 16L:8D photoperiod. These test fish were fed brine shrimp nauplii twice daily.

Each day of the tests, fresh test solutions were prepared as before. The test replicate beakers were examined, with any dead animals, uneaten food, wastes, and other detritus being removed. The number of live fish in each replicate was determined and then approximately 80% of the test media in each beaker was carefully poured out and replaced with fresh media. “Old” water quality characteristics (pH and D.O.) were measured on the old test water collected from one randomly selected replicate at each treatment. The test beakers were then placed back into the temperature-controlled room.

After 7 days exposure, the tests were terminated and the number of live fish in each replicate beaker was recorded. The fish from each replicate were then carefully euthanized in methanol, rinsed in de-ionized water, and transferred to a pre-dried and pre-tared weighing pan. The fish were then dried at 100°C for ≥24 hours and re-weighed to determine the total weight of fish in each replicate. The total weight was then divided by the initial number of fish per replicate to determine the biomass value. The resulting survival and biomass value data were analyzed to determine any impairment(s) caused by the effluent. All statistical analyses were performed using CETIS (Tidepool Scientific Software, McKinleyville, CA).

2.3 Reference Toxicant Testing of the *Atherinops affinis*

The reference toxicant test was performed similarly to the effluent tests, but used test solutions consisting of Lab Water Control media spiked with copper chloride at concentrations of 56, 100, 180, 320, 560, and 1000 µg Cu/L. The resulting test response data were analyzed to determine key dose-response point estimates. All statistical analyses were made using CETIS. These response endpoints were then compared to the typical response ranges established by the mean ± 2 SD of the point estimates generated by the most recent previous reference toxicant tests performed by this lab.



3. TESTING RESULTS

3.1 Chronic Toxicity of Crescent City Effluent to *Atherinops affinis*

The results of this test are summarized in Table 2. There were no reductions in survival or growth; the TST analysis resulted in a pass for both endpoints. The test data and summary of statistics for this test are attached as Appendix B.

Table 2. Chronic toxicity of Crescent City effluent to <i>Atherinops affinis</i> .		
Effluent Treatment	Mean % Survival	Mean Biomass Value (mg)
Salt Control	64	1.03
Lab Water Control	84	1.27
3.45%	92	1.73
Summary of Statistics		
Percent (%) Effect =	No reduction	No reduction
TST Analysis =	Pass	Pass

3.2 Reference Toxicant Toxicity to *Atherinops affinis*

The results of this test are summarized in Table 3. The EC₅₀ and IC₅₀ for this test were consistent with the typical response ranges established by the reference toxicant test database for this species, indicating that the organisms used in these tests were responding to toxic stress in a typical fashion. The test data and summary of statistics for this test are attached as Appendix C.

Table 3. Reference toxicant testing: Effects of CuCl ₂ on <i>Atherinops affinis</i> .		
CuCl ₂ Concentration (µg/L)	Mean % Survival	Mean Biomass Value (mg)
Lab Water Control	88	1.76
56	84	1.86
100	88	1.67
180	40*	0.58
320	16*	0.22
560	0*	-
1000	0*	-
Summary of Key Statistics		
Survival EC ₅₀ or Growth IC ₅₀ =	192 µg/L CuCl ₂	156 µg/L CuCl ₂

* The response at this test treatment was significantly less than the Lab Water Control treatment response ($p < 0.05$).



4. SUMMARY AND CONCLUSIONS

An evaluation of the chronic toxicity of Crescent City effluent was performed using an effluent sample collected August 20, 22, and 24, 2018. The results of this test are summarized below.

Chronic Toxicity of Crescent City Effluent to *Atherinops affinis*

There were no reductions in survival or growth; the TST analysis resulted in a pass for both endpoints.

4.1 QA/QC Summary

Test Conditions – Test conditions (pH, D.O., temperature, etc.) were within acceptable limits. All analyses were performed according to laboratory Standard Operating Procedures.

Negative Control – The biological response of the Lab Control treatment was within acceptable limits.

Positive Control – The results of the reference toxicant test were consistent with the typical response ranges established by the reference toxicant test database for this species, indicating that the test organisms were responding to toxicant stress in a typical and consistent fashion.

Concentration Response Relationships – The concentration-response relationships for these tests were evaluated per EPA guidelines (EPA-821-B-00-004) and were determined to be acceptable.



Appendix A

Chain-of-Custody Record for the Collection and Delivery of the Sample



Pacific EcoRisk
 2250 Cordelia Rd., Fairfield, CA 94534
 (707) 207-7760 FAX (707) 207-7916

CHAIN-OF-CUSTODY RECORD

Results To: Crescent City Water Quality Control Lab		Invoice To: Same		REQUESTED ANALYSIS																	
Address: 3775 195 B Street Crescent City, CA 95531		Address: 377 J Street Crescent City, CA 95531		Atherinops affinis Survival and Growth, EPA- 800-R-95-136																	
Phone: 707-465-5258		Phone:																			
Attn: Tara Wood		Attn:																			
E-mail: twood@crescentcity.org		E-mail: twood@crescentcity.org																			
Project Name: Crescent City																					
P.O.#/Ref:																					
Client Sample ID	Sample Date	Sample Time	Sample Matrix*	Grab/Comp	Container		X														
					Number	Type															
1	EFF-001	8/20/18	1305	EFF	Grab	1	1-gal cubitainer														
2																					
3																					
4																					
5																					
6																					
7																					
8																					
9																					
10																					
Samples collected by: Jesse Wood																					
Comments/Special Instruction:				RELINQUISHED BY:								RECEIVED BY: Tara Wood									
				Signature: <i>Jesse Wood</i>				Signature: <i>Tara Wood</i>				Signature: <i>Tara Wood</i>									
				Print: Jesse Wood				Print: Tara Wood				Print: Tara Wood									
				Organization: City of Crescent City ^{WQCF}				Organization: City of Crescent City ^{WQCF}				Organization: City of Crescent City ^{WQCF}									
				Date: 8/20/18 Time: 1314				Date: 8/20/18 Time: 1314				Date: 8/20/18 Time: 1314									
				Date: 8/20/18 Time: 1314				Date: 8/20/18 Time: 1314				Date: 8/20/18 Time: 1314									
				RELINQUISHED BY:								RECEIVED BY:									
				Signature: <i>Tara Wood</i>				Signature: <i>David Hand</i>				Signature: <i>David Hand</i>									
				Print: Tara Wood				Print: David Hand				Print: David Hand									
				Organization: City of Crescent City				Organization: PER				Organization: PER									
				Date: 8/20/18 Time: 1314				Date: 8/20/18 Time: 1314				Date: 8/20/18 Time: 1120									
				Date: 8/20/18 Time: 1314				Date: 8/20/18 Time: 1314				Date: 8/20/18 Time: 1120									

*Example Matrix Codes: (EFF - Effluent) (FW = Freshwater); (SW = Saltwater); (WW = Wastewater); (STRMW = Stormwater); (SED = Sediment); or other



Pacific EcoRisk
 2250 Cordelia Rd., Fairfield, CA 94534
 (707) 207-7760 FAX (707) 207-7916

CHAIN-OF-CUSTODY RECORD

Results To: Crescent City Water Quality Control Lab		Invoice To: Same		REQUESTED ANALYSIS																		
Address: 195 B Street Crescent City, CA 95531		Address:		Athenrops affinis Survival and Growth, EPA-600-R-95-136																		
Phone: 707-465-5258		Phone:																				
Attn: Tara Wood		Attn:																				
E-mail: twood@crescentcity.org		E-mail:																				
Project Name: Crescent City																						
P.O.#/Ref:																						
Client Sample ID	Sample Date	Sample Time	Sample Matrix*	Grab/Comp	Container		X															
					Number	Type																
1 EFF-001	8/22/18	1330	EFF	Grab	1	1-gal cubitainer	X															
2																						
3																						
4																						
5																						
6																						
7																						
8																						
9																						
10																						
Samples collected by:																						
Comments/Special Instruction: <div style="text-align: center; font-size: 2em; font-family: cursive;">CF = CWW</div>				RELINQUISHED BY:					RECEIVED BY:													
				Signature: <i>[Signature]</i>					Signature: <i>[Signature]</i>													
				Print: Elizabeth Martinec					Print: Regina Thom													
				Organization: Crescent City WWTP					Organization: CCWQC													
				Date: 8-22-18 Time: 1332					Date: 8/22/18 Time: 1332													
				RELINQUISHED BY:					RECEIVED BY:													
Signature:					Signature: <i>[Signature]</i>																	
Print:					Print: MONICA LAZORIK																	
Organization:					Organization: PER																	
Date:					Date: 8/23/18 Time: 1035																	

*Example Matrix Codes: (EFF - Effluent) (FW = Freshwater); (SW = Saltwater); (WW = Wastewater); (STRMW = Stormwater); (SED = Sediment); or other



Pacific EcoRisk
 2250 Cordelia Rd., Fairfield, CA 94534
 (707) 207-7760 FAX (707) 207-7916

CHAIN-OF-CUSTODY RECORD

Results To: Crescent City Water Quality Control Lab		Invoice To: Same		REQUESTED ANALYSIS													
Address: 195 B Street Crescent City, CA 95531		Address:		Atherinops affinis Survival and Growth, EPA-600-R-95-136													
Phone: 707-465-5258		Phone:															
Attn: Tara Wood		Attn:															
E-mail: twood@crescentcity.org		E-mail:															
Project Name: Crescent City		P.O.#/Ref:															
Client Sample ID	Sample Date	Sample Time	Sample Matrix*	Grab/Comp	Container		X										
					Number	Type											
1 EFF-001	8/24/18	1336	EFF	Grab	1	1-gal cubitainer	X										
2																	
3																	
4																	
5																	
6																	
7																	
8																	
9																	
10																	
Samples collected by: Trevor McAffrey																	
Comments/Special Instruction:				RELINQUISHED BY: Trevor McAffrey						RECEIVED BY:							
				Signature: <i>Trevor McAffrey</i>						Signature: <i>Corinne Fuoco</i>							
				Print: <i>Trevor McAffrey</i>						Print: <i>Corinne Fuoco</i>							
				Organization: <i>CCWWTP</i>						Organization: <i>CCWQL</i>							
				Date: <i>8/24/18</i> Time: <i>1336</i>						Date: <i>8/24/18</i> Time: <i>1336</i>							
				RELINQUISHED BY:						RECEIVED BY:							
				Signature: <i>Corinne Fuoco</i>						Signature: <i>Nyasha Afari</i>							
				Print: <i>Corinne Fuoco</i>						Print: <i>Nyasha Afari</i>							
				Organization: <i>CCWQL</i>						Organization: <i>PER</i>							
				Date: <i>8/24/18</i> Time: <i>1348</i>						Date: <i>8/25/18</i> Time: <i>0955</i>							

*Example Matrix Codes: (EFF - Effluent) (FW = Freshwater); (SW = Saltwater); (WW = Wastewater); (STRMW = Stormwater); (SED = Sediment); or other

Appendix B

Test Data and Summary of Statistics for the Evaluation of the Chronic Toxicity of Crescent City Effluent to *Atherinops affinis*

CETIS Summary Report

Report Date: 30 Aug-18 12:05 (p 1 of 1)
 Test Code: 79323 | 02-3161-6219

Chronic Larval Fish Survival and Growth Test	Pacific EcoRisk
---	------------------------

Batch ID: 06-1008-6734	Test Type: Growth-Survival (7d)	Analyst: Ashleigh Findley
Start Date: 21 Aug-18 14:35	Protocol: EPA/600/R-95/136 (1995)	Diluent: Filtered Seawater
Ending Date: 28 Aug-18 08:00	Species: Atherinops affinis	Brine: Crystal Sea
Duration: 6d 17h	Source: Aquatic Biosystems, CO	Age: 14

Sample ID: 17-0888-1972	Code: EFF	Client: Crescent City
Sample Date: 20 Aug-18 13:05	Material: Effluent	Project: 29193
Receipt Date: 21 Aug-18 11:20	Source: City of Crescent City	
Sample Age: 26h (0.1 °C)	Station: EFF-001	

Single Comparison Summary				
Analysis ID	Endpoint	Comparison Method	P-Value	Comparison Result
20-2751-2680	7d Survival Rate	TST-Welch's t Test	0.3306	Salt Control failed 7d survival rate
19-3278-9136	7d Survival Rate	TST-Welch's t Test	0.0016	3.45% passed 7d survival rate
14-1794-8285	Mean Dry Biomass-mg	TST-Welch's t Test	0.3673	Salt Control failed mean dry biomass-mg
05-0393-3412	Mean Dry Biomass-mg	TST-Welch's t Test	0.0016	3.45% passed mean dry biomass-mg

7d Survival Rate Summary											
Conc-%	Code	Count	Mean	95% LCL	95% UCL	Min	Max	Std Err	Std Dev	CV%	%Effect
0	LW	5	0.840	0.632	1.000	0.600	1.000	0.075	0.167	19.92%	0.00%
0	SA	5	0.640	0.316	0.964	0.200	0.800	0.117	0.261	40.75%	23.81%
3.45		5	0.920	0.784	1.000	0.800	1.000	0.049	0.110	11.91%	-9.52%

Mean Dry Biomass-mg Summary											
Conc-%	Code	Count	Mean	95% LCL	95% UCL	Min	Max	Std Err	Std Dev	CV%	%Effect
0	LW	5	1.27	0.846	1.7	0.924	1.7	0.154	0.344	27.03%	0.00%
0	SA	5	1.03	0.574	1.48	0.514	1.39	0.162	0.363	35.43%	19.48%
3.45		5	1.73	1.36	2.1	1.5	2.1	0.134	0.301	17.37%	-35.91%

7d Survival Rate Detail						
Conc-%	Code	Rep 1	Rep 2	Rep 3	Rep 4	Rep 5
0	LW	0.600	0.800	0.800	1.000	1.000
0	SA	0.800	0.600	0.800	0.200	0.800
3.45		1.000	1.000	0.800	0.800	1.000

Mean Dry Biomass-mg Detail						
Conc-%	Code	Rep 1	Rep 2	Rep 3	Rep 4	Rep 5
0	LW	0.924	1.13	1.03	1.58	1.7
0	SA	1.12	0.804	1.3	0.514	1.39
3.45		1.5	2.1	1.53	1.5	2.02

7d Survival Rate Binomials						
Conc-%	Code	Rep 1	Rep 2	Rep 3	Rep 4	Rep 5
0	LW	3/5	4/5	4/5	5/5	5/5
0	SA	4/5	3/5	4/5	1/5	4/5
3.45		5/5	5/5	4/5	4/5	5/5

CETIS Analytical Report

Report Date: 30 Aug-18 12:05 (p 1 of 4)
 Test Code: 79323 | 02-3161-6219

Chronic Larval Fish Survival and Growth Test **Pacific EcoRisk**

Analysis ID: 19-3278-9136 Endpoint: 7d Survival Rate CETIS Version: CETISv1.9.2
 Analyzed: 30 Aug-18 12:04 Analysis: Parametric Bioequivalence-Two Sample Official Results: Yes

Data Transform	Alt Hyp	TST_b	Comparison Result
Angular (Corrected)	C*b < T	0.75	3.45% passed 7d survival rate

TST-Welch's t Test

Control	vs	Control II	Test Stat	Critical	DF	P-Type	P-Value	Decision(α:25%)
Lab Water Contr		3.45*	4.37	0.711	7	CDF	0.0016	Non-Significant Effect

ANOVA Table

Source	Sum Squares	Mean Square	DF	F Stat	P-Value	Decision(α:5%)
Between	0.021087	0.021087	1	0.776	0.4040	Non-Significant Effect
Error	0.217313	0.0271641	8			
Total	0.2384		9			

Distributional Tests

Attribute	Test	Test Stat	Critical	P-Value	Decision(α:1%)
Variances	Variance Ratio F Test	2.19	23.2	0.4655	Equal Variances
Distribution	Shapiro-Wilk W Normality Test	0.919	0.741	0.3483	Normal Distribution

7d Survival Rate Summary

Conc-%	Code	Count	Mean	95% LCL	95% UCL	Median	Min	Max	Std Err	CV%	%Effect
0	LW	5	0.840	0.632	1.000	0.800	0.600	1.000	0.075	19.92%	0.00%
3.45		5	0.920	0.784	1.000	1.000	0.800	1.000	0.049	11.91%	-9.52%

Angular (Corrected) Transformed Summary

Conc-%	Code	Count	Mean	95% LCL	95% UCL	Median	Min	Max	Std Err	CV%	%Effect
0	LW	5	1.16	0.918	1.4	1.11	0.886	1.35	0.0864	16.68%	0.00%
3.45		5	1.25	1.09	1.41	1.35	1.11	1.35	0.0583	10.43%	-7.93%

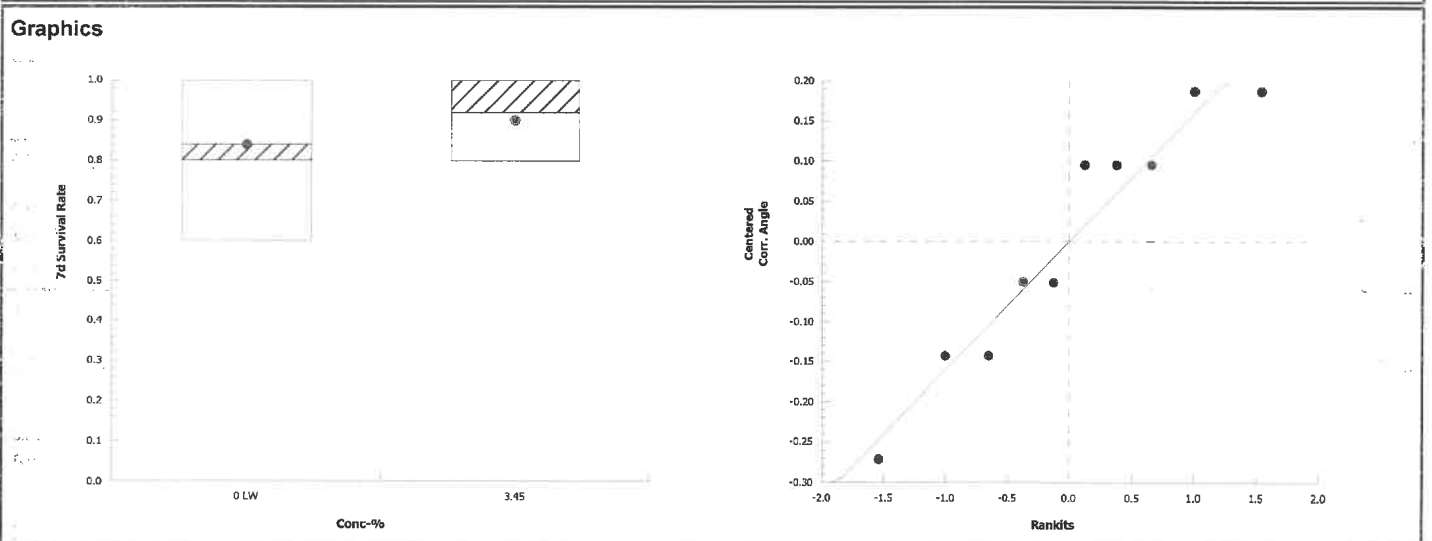

CETIS Analytical Report

Report Date: 30 Aug-18 12:05 (p 2 of 4)
 Test Code: 79323 | 02-3161-6219

Chronic Larval Fish Survival and Growth Test **Pacific EcoRisk**

Analysis ID: 20-2751-2680 Endpoint: 7d Survival Rate CETIS Version: CETISv1.9.2
 Analyzed: 30 Aug-18 12:05 Analysis: Parametric Bioequivalence-Two Sample Official Results: Yes

Data Transform	Alt Hyp	TST_b	Comparison Result
Angular (Corrected)	C*b < T	0.75	Salt Control failed 7d survival rate

TST-Welch's t Test

Control	vs	Control II	Test Stat	Critical	DF	P-Type	P-Value	Decision(α:25%)
Lab Water Contr		Salt Control	0.465	0.727	5	CDF	0.3306	Significant Effect

ANOVA Table

Source	Sum Squares	Mean Square	DF	F Stat	P-Value	Decision(α:5%)
Between	0.125388	0.125388	1	2.17	0.1791	Non-Significant Effect
Error	0.462732	0.0578416	8			
Total	0.588121		9			

Distributional Tests

Attribute	Test	Test Stat	Critical	P-Value	Decision(α:1%)
Variances	Variance Ratio F Test	2.1	23.2	0.4901	Equal Variances
Distribution	Shapiro-Wilk W Normality Test	0.811	0.741	0.0199	Normal Distribution

7d Survival Rate Summary

Conc-%	Code	Count	Mean	95% LCL	95% UCL	Median	Min	Max	Std Err	CV%	%Effect
0	LW	5	0.840	0.632	1.000	0.800	0.600	1.000	0.075	19.92%	0.00%
0	SA	5	0.640	0.316	0.964	0.800	0.200	0.800	0.117	40.75%	23.81%

Angular (Corrected) Transformed Summary

Conc-%	Code	Count	Mean	95% LCL	95% UCL	Median	Min	Max	Std Err	CV%	%Effect
0	LW	5	1.16	0.918	1.4	1.11	0.886	1.35	0.0864	16.68%	0.00%
0	SA	5	0.934	0.587	1.28	1.11	0.464	1.11	0.125	29.96%	19.34%

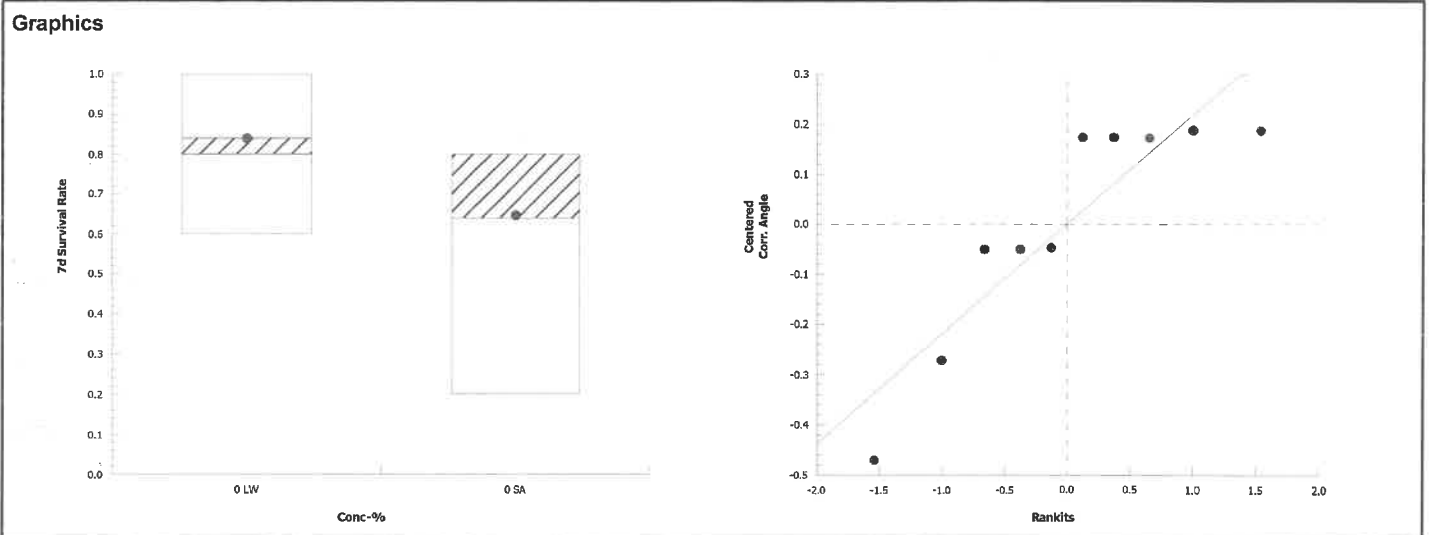

CETIS Analytical Report

Report Date: 30 Aug-18 12:05 (p 3 of 4)
 Test Code: 79323 | 02-3161-6219

Chronic Larval Fish Survival and Growth Test **Pacific EcoRisk**

Analysis ID: 05-0393-3412 Endpoint: Mean Dry Biomass-mg CETIS Version: CETISv1.9.2
 Analyzed: 30 Aug-18 12:04 Analysis: Parametric Bioequivalence-Two Sample Official Results: Yes

Data Transform	Alt Hyp	TST_b	Comparison Result
Untransformed	C*b < T	0.75	3.45% passed mean dry biomass-mg

TST-Welch's t Test

Control	vs	Control II	Test Stat	Critical	DF	P-Type	P-Value	Decision(α:25%)
Lab Water Contr		3.45*	4.38	0.711	7	CDF	0.0016	Non-Significant Effect

ANOVA Table

Source	Sum Squares	Mean Square	DF	F Stat	P-Value	Decision(α:5%)
Between	0.522579	0.522579	1	5.01	0.0556	Non-Significant Effect
Error	0.835021	0.104378	8			
Total	1.3576		9			

Distributional Tests

Attribute	Test	Test Stat	Critical	P-Value	Decision(α:1%)
Variances	Variance Ratio F Test	1.31	23.2	0.7991	Equal Variances
Distribution	Shapiro-Wilk W Normality Test	0.811	0.741	0.0198	Normal Distribution

Mean Dry Biomass-mg Summary

Conc-%	Code	Count	Mean	95% LCL	95% UCL	Median	Min	Max	Std Err	CV%	%Effect
0	LW	5	1.27	0.846	1.7	1.13	0.924	1.7	0.154	27.03%	0.00%
3.45		5	1.73	1.36	2.1	1.53	1.5	2.1	0.134	17.37%	-35.91%

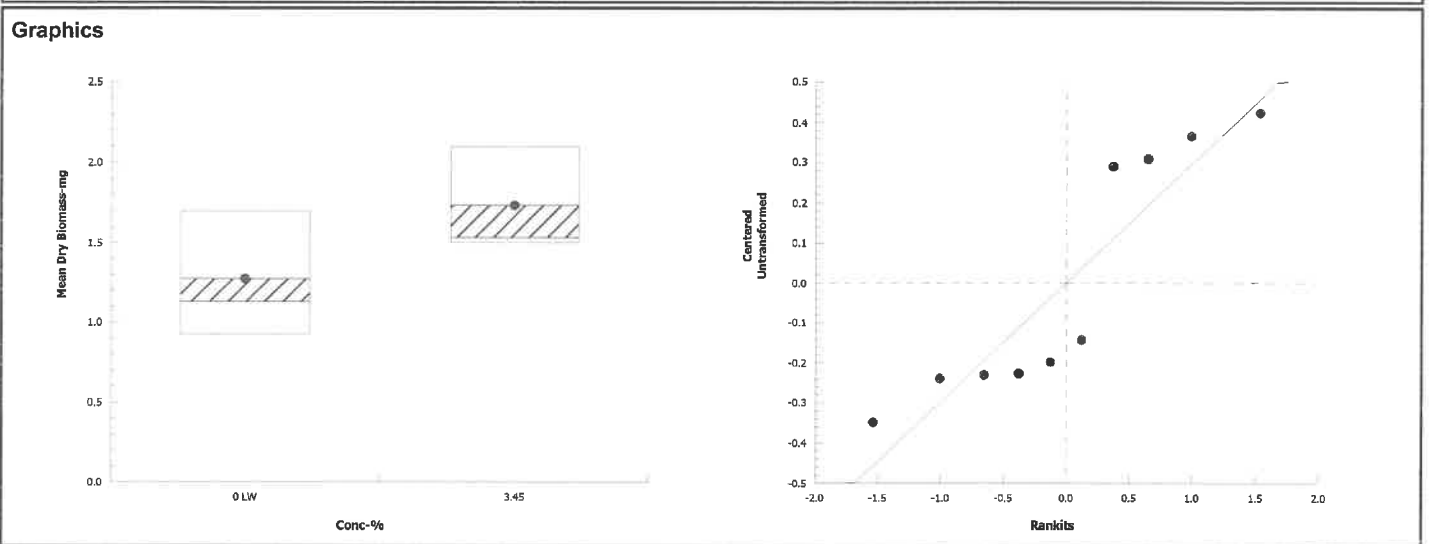

CETIS Analytical Report

Report Date: 30 Aug-18 12:05 (p 4 of 4)
 Test Code: 79323 | 02-3161-6219

Chronic Larval Fish Survival and Growth Test **Pacific EcoRisk**

Analysis ID: 14-1794-8285 Endpoint: Mean Dry Biomass-mg CETIS Version: CETISv1.9.2
 Analyzed: 30 Aug-18 12:05 Analysis: Parametric Bioequivalence-Two Sample Official Results: Yes

Data Transform	Alt Hyp	TST_b	Comparison Result
Untransformed	C*b < T	0.75	Salt Control failed mean dry biomass-mg

TST-Welch's t Test

Control	vs	Control II	Test Stat	Critical	DF	P-Type	P-Value	Decision(α:25%)
Lab Water Contr		Salt Control	0.353	0.711	7	CDF	0.3673	Significant Effect

ANOVA Table

Source	Sum Squares	Mean Square	DF	F Stat	P-Value	Decision(α:5%)
Between	0.153762	0.153762	1	1.23	0.3000	Non-Significant Effect
Error	1.00161	0.125201	8			
Total	1.15537		9			

Distributional Tests

Attribute	Test	Test Stat	Critical	P-Value	Decision(α:1%)
Variances	Variance Ratio F Test	1.11	23.2	0.9191	Equal Variances
Distribution	Shapiro-Wilk W Normality Test	0.918	0.741	0.3418	Normal Distribution

Mean Dry Biomass-mg Summary

Conc-%	Code	Count	Mean	95% LCL	95% UCL	Median	Min	Max	Std Err	CV%	%Effect
0	LW	5	1.27	0.846	1.7	1.13	0.924	1.7	0.154	27.03%	0.00%
0	SA	5	1.03	0.574	1.48	1.12	0.514	1.39	0.162	35.43%	19.48%

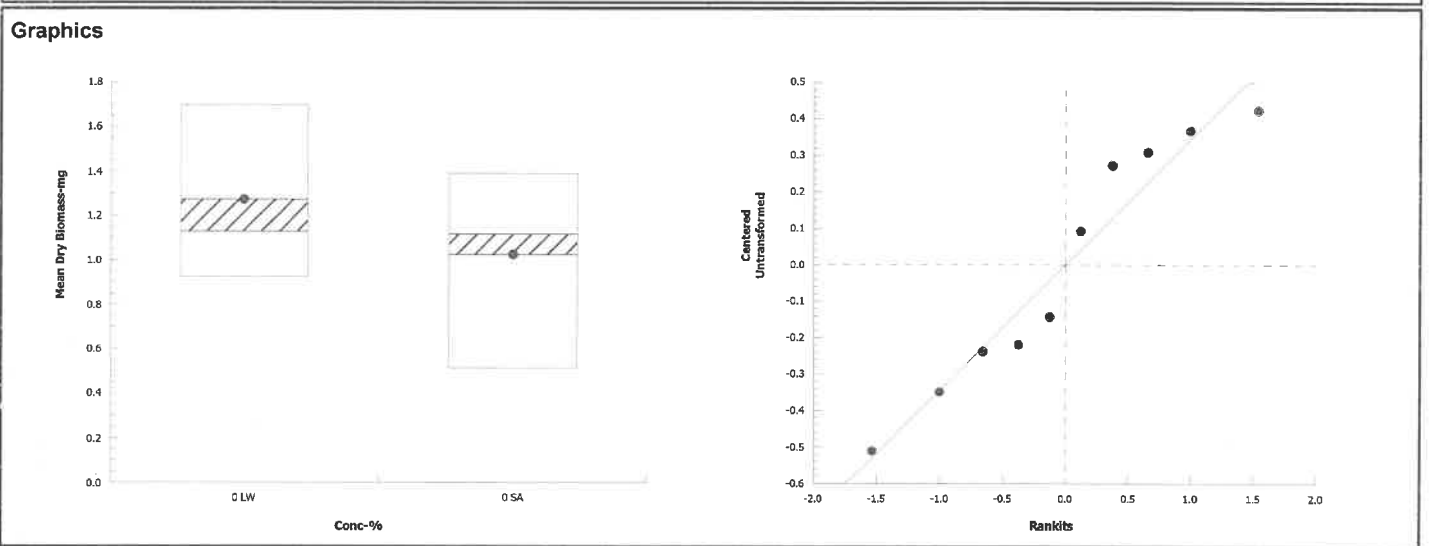

7 Day Chronic Topsmelt (*A. affinis*) Toxicity Test Data

Client: Crescent City Organism Log#: 1143 Age: 14d
 Test Material: Salt Control Test Date: 8/21/18 Organism Supplier: ABS
 Test ID#: 79323 Project #: 29193 Control Water: Diluted Filtered Seawater + Crystal Sea

Test Treatment	Temp (°C)	pH		D.O. (mg/L)		Salinity (ppt)	# Live Organisms					SIGN-OFF
		new	old	new	old		new	A	B	C	D	
Salt Control	20.1	7.69		7.9		33.3	5	5	5	5	5	Date: 8/21/18 Test Solution Prep: SF Initiation Time: 1435 Initiation Signoff: SF
Meter ID	81A	PH24		RD11		EC11	New WQ: DH					
Salt Control	20.5	7.92	7.62	7.5	6.2	32.7	5	5	5	5	5	Date: 8/22/18 Test Solution Prep: LB Renewal Time: 1525 Renewal Signoff: LB
Meter ID	99A	PH25	PH15	RD10	RD10	EC10	New WQ: DM		Old WQ: JR			
Salt Control	20.4	7.87	7.69	8.5	6.6	32.4	5	5	5	5	5	Date: 8/23/18 Test Solution Prep: JL Renewal Time: 1520 Renewal Signoff: JL
Meter ID	100A	PH25	PH25	RD10	RD10	EC10	New WQ: DM		Old WQ: DM			
Salt Control	20.5	8.11	7.84	8.5	6.6	32.3	5	5	5	5	5	Date: 8/24/18 Test Solution Prep: RB Renewal Time: 1052 Renewal Signoff: RB
Meter ID	81A	PH19	PH25	RD11	RD10	EC11	New WQ: F1		Old WQ: TA			
Salt Control	20.8	7.90	7.77 7.64 SF 8/23/18	8.1	6.3	32.4	4	4 4 ^{8/24}	4	4 4 ^{8/24}	5	Date: 8/25/18 Test Solution Prep: LB Renewal Time: 1511 Renewal Signoff: HPP
Meter ID	81A	PH25	PH24	RD11	RD10	EC11	New WQ: AR		Old WQ: JR			
Salt Control	20.7	8.24	7.71	7.8	6.1	33.7	4	3	4	3	5	Date: 8/26/18 Test Solution Prep: EP Renewal Time: 1145 Renewal Signoff: TK
Meter ID	40A	PH25	PH25	RD12	RD12	EC11	New WQ: MYL		Old WQ: MYL			
Salt Control	20.6	8.25	7.72 7.97 DE 8/27/18	9.0	6.2 6.5 DE 8/27/18	34.0	4	3	4	2	4	Date: 8/27/18 Test Solution Prep: EP Renewal Time: 1135 Renewal Signoff: TK
Meter ID	100A	PH25	PH19	RD11	RD10	EC13	New WQ: RB		Old WQ: AR			
Salt Control	20.1		8.04		6.2	33.8	4	3	4	1	4	Date: 8/28/18 Termination Time: 0800 Termination Signoff: JL
Meter ID	100A		PH25		RD10	EC10	Old WQ: DM					

7 Day Chronic Topsmelt (*A. affinis*) Toxicity Test Data

Client: Crescent City Organism Log#: 11143 Age: 14 days
 Test Material: Effluent Test Date: 8/21/18 Organism Supplier: ABS
 Test ID#: 79323 Project #: 29193 Control Water: Filtered Seawater

Test Treatment	Temp (°C)	pH		D.O. (mg/L)		Salinity (ppt)	# Live Organisms					SIGN-OFF
		new	old	new	old		A	B	C	D	E	
Lab Control	20.2	7.85		8.2		33.7	5	5	5	5	5	Date: 8/21/18 Test Solution Prep: SF
3.45%	20.8	7.91		8.1		33.6	5	5	5	5	5	Initiation Time: 1435 Initiation Signoff: SR
Meter ID	81A	PH24		RD11		EC11	New WQ: DH					Sample ID: 50640
Lab Control	20.5	7.87	7.52	7.5	5.3	34.0	5	5	5	5	5	Date: 8/22/18 Test Solution Prep: LB
3.45%	20.4	7.86	7.53	7.5	5.1	32.7	5	5	5	5	5	Renewal Time: 1525 Renewal Signoff: LB
Meter ID	99A	PH25	PH15	RD10	RD10	EC10	New WQ: DM		Old WQ: SR			Sample ID: 50640
Lab Control	20.5	7.87	7.70	8.6	6.3	33.8	5	5	5	5	5	Date: 8/23/18 Test Solution Prep: JL
3.45%	20.7	7.85	7.69	8.5	6.4	32.7	5	5	5	5	5	Renewal Time: 1520 Renewal Signoff: JL
Meter ID	100A	PH25	PH25	RD10	RD10	EC10	New WQ: 8573		Old WQ: DM			Sample ID: 50677
Lab Control	20.1	8.05	7.83	9.4	6.6	32.9	5	5	5	5	5	Date: 8/24/18 Test Solution Prep: RB
3.45%	20.1	8.02	7.84	9.2	6.5	32.4	5	5	5	5	5	Renewal Time: 1057 Renewal Signoff: RB
Meter ID	81A	PH19	PH25	RD11	RD10	EC12	New WQ: FT		Old WQ: TA			Sample ID: 50677
Lab Control	20.6	7.86	7.71	8.3	6.3	32.3	4	4	5	5	5	Date: 8/25/18 Test Solution Prep: LB
3.45%	20.5	7.84	7.71	8.3	6.3	32.7 31.4 AR 8/25/18	5	5	5	4	5	Renewal Time: 1511 Renewal Signoff: JFF
Meter ID	81A	PH25	PH24	RD11	RD10	EC11	New WQ: AR		Old WQ: SR			Sample ID: 50693
Lab Control	20.6	7.91	7.77	9.1	6.3	33.7	4	4	5	5	5	Date: 8/26/18 Test Solution Prep: EF
3.45%	20.4	7.92	7.73	8.0	6.2	33.7	5	5	5	4	5	Renewal Time: 1145 Renewal Signoff: TK
Meter ID	40A	PH25	PH25	RD12	RD12	EC11	New WQ: MAL		Old WQ: MAL			Sample ID: 50693
Lab Control	20.5	7.90	7.73	8.0	6.4	34.0	3	4	5	5	5	Date: 8/27/18 Test Solution Prep: EP
3.45%	20.3	7.90	7.77	8.1	6.5	34.0	5	5	5	4	5	Renewal Time: 1135 Renewal Signoff: TK
Meter ID	100A	PH25	PH19	RD11	RD10	EC13	New WQ: KB		Old WQ: AR			Sample ID: 50693
Lab Control	20.1		7.90		6.4	33.8	3	4	4	5	5	Date: 8/28/18 Termination Time: 0800
3.45%	20.0		7.88		6.5	33.7	5	5	4	4	5	Termination Signoff: JL
Meter ID	110A		PH25		RD10	EC10			Old WQ: DM			

Chronic Topsmelt Dry Weight and Biomass Data

Client: Crescent City Test ID #: 79323 Project # 29193
 Sample: Effluent Tare Weight Date: 8/25/18 Sign-off: RAP
 Test Date: _____ Final Weight Date: 8/29/18 Sign-off: 74

Pan ID	Concentration	Replicate	Initial Pan Weight (mg)	Final Pan Weight (mg)	Initial # of Organisms	Biomass Value (mg)
1	Control	A	414.23	418.85	5	0.924
2		B	413.46	419.11	5	1.130
3		C	418.09	423.26	5	1.034
4		D	410.83	418.74	5	1.582
5		E	401.40	409.88	5	1.696
11 6	Effluent	A	412.07	419.57	5	1.500
12 7	3.45%	B	417.25	417.73	5	2.096
13 8		C	406.25	413.91	5	1.532
14 9		D	415.04	422.56	5	1.504
15 10		E	419.69	429.79	5	2.020
QA 1			403.96	403.96		
Balance ID			BAL04	BAL04		

Chronic Topsmelt Dry Weight Data

Client: Crescent City Test ID #: 79323 Project # 29193
 Sample: Salt Control Initial Weight Date: 8/25/18 Sign-off: RAP
 Test Date: _____ Final Weight Date: 8/29/18 Sign-off: [Signature]

Pan ID	Concentration	Replicate	Initial Pan Weight (mg)	Final Pan Weight (mg)	Initial # of Organisms	Biomass Value (mg)
<u>3611</u>	<u>Salt</u>	<u>A</u>	<u>416.59</u>	<u>422.18</u>	<u>5</u>	<u>1.118</u>
<u>3712</u>	<u>Control</u>	<u>B</u>	<u>408.88</u>	<u>412.90</u>	<u>5</u>	<u>0.804</u>
<u>3813</u>		<u>C</u>	<u>413.00</u>	<u>419.49</u>	<u>5</u>	<u>1.298</u>
<u>3914</u>		<u>D</u>	<u>410.32</u>	<u>412.89</u>	<u>5</u>	<u>0.514</u>
<u>4015</u>		<u>E</u>	<u>413.47</u>	<u>420.43</u>	<u>5</u>	<u>1.392</u>

Appendix C

Test Data and Summary of Statistics for the Reference Toxicant Evaluation of the *Atherinops affinis*

CETIS Summary Report

Report Date: 30 Aug-18 11:34 (p 1 of 2)
 Test Code: 79324 | 00-3551-6424

Chronic Larval Fish Survival and Growth Test **Pacific EcoRisk**

Batch ID: 06-3400-3382	Test Type: Growth-Survival (7d)	Analyst: Ashleigh Findley
Start Date: 21 Aug-18 16:01	Protocol: EPA/600/R-95/136 (1995)	Diluent: Filtered Seawater
Ending Date: 28 Aug-18 08:55	Species: Atherinops affinis	Brine: Not Applicable
Duration: 6d 17h	Source: Aquatic Biosystems, CO	Age: 14

Sample ID: 13-4967-1792	Code: CuCl2	Client: Pacific Ecorisk
Sample Date: 21 Aug-18 16:01	Material: Copper chloride	Project: 29194
Receipt Date: 21 Aug-18 16:01	Source: Reference Toxicant	
Sample Age: n/a (20.1 °C)	Station: In House	

Multiple Comparison Summary

Analysis ID	Endpoint	Comparison Method	NOEL	LOEL	TOEL	TU	PMSD ✓
15-1009-1134	7d Survival Rate	Dunnett Multiple Comparison Test	100	180	134.2		20.8%
17-1018-8398	Mean Dry Biomass-mg	Dunnett Multiple Comparison Test	100	> 100	n/a		48.2%

Point Estimate Summary

Analysis ID	Endpoint	Point Estimate Method	Level	µg/L	95% LCL	95% UCL	TU	✓
13-5488-9353	7d Survival Rate	Regression: Log-Normal (Probit)	EC5	91.9	41	128		
			EC10	108	54.6	145		
			EC15	121	66.2	157		
			EC20	132	76.9	168		
			EC25	142	87.4	178		
			EC40	171	119	209		
			EC50	192	143	232		
11-2151-1794	Mean Dry Biomass-mg	Linear Interpolation (ICPIN)	IC5	84.7	n/a	117		
			IC10	103	n/a	118		
			IC15	110	6.17	125		
			IC20	116	23.2	131		
			IC25	123	59.8	138		
			IC40	143	84.3	158		
			IC50	156	114	172		

7d Survival Rate Summary

Conc-µg/L	Code	Count	Mean	95% LCL	95% UCL	Min	Max	Std Err	Std Dev	CV%	%Effect
0	LW	5	0.880	0.744	1.000	0.800	1.000	0.049	0.110	12.45%	0.00%
56		5	0.840	0.632	1.000	0.600	1.000	0.075	0.167	19.92%	4.55%
100		5	0.880	0.744	1.000	0.800	1.000	0.049	0.110	12.45%	0.00%
180		5	0.400	0.400	0.400	0.400	0.400	0.000	0.000	0.00%	54.55%
320		5	0.160	0.000	0.368	0.000	0.400	0.075	0.167	104.58%	81.82%
560		5	0.000	0.000	0.000	0.000	0.000	0.000	0.000		100.00%
1000		5	0.000	0.000	0.000	0.000	0.000	0.000	0.000		100.00%

Mean Dry Biomass-mg Summary

Conc-µg/L	Code	Count	Mean	95% LCL	95% UCL	Min	Max	Std Err	Std Dev	CV%	%Effect
0	LW	5	1.76	1.21	2.31	1.14	2.35	0.199	0.445	25.29%	0.00%
56		5	1.86	0.868	2.84	1.27	3.25	0.356	0.796	42.87%	-5.50%
100		5	1.67	0.901	2.44	0.724	2.31	0.277	0.618	37.05%	5.14%
180		5	0.583	0.323	0.842	0.336	0.88	0.0935	0.209	35.86%	66.88%
320		5	0.218	-0.125	0.562	0	0.67	0.124	0.276	126.54%	87.59%
560		5	0	0	0	0	0	0	0		100.00%
1000		5	0	0	0	0	0	0	0		100.00%

CETIS Summary Report

Report Date: 30 Aug-18 11:34 (p 2 of 2)
 Test Code: 79324 | 00-3551-6424

Chronic Larval Fish Survival and Growth Test							Pacific EcoRisk
7d Survival Rate Detail							
Conc-µg/L	Code	Rep 1	Rep 2	Rep 3	Rep 4	Rep 5	
0	LW	1.000	0.800	0.800	1.000	0.800	
56		0.800	0.600	1.000	1.000	0.800	
100		0.800	0.800	0.800	1.000	1.000	
180		0.400	0.400	0.400	0.400	0.400	
320		0.200	0.000	0.400	0.000	0.200	
560		0.000	0.000	0.000	0.000	0.000	
1000		0.000	0.000	0.000	0.000	0.000	
Mean Dry Biomass-mg Detail							
Conc-µg/L	Code	Rep 1	Rep 2	Rep 3	Rep 4	Rep 5	
0	LW	2.35	1.6	1.14	1.95	1.77	
56		1.64	1.27	3.25	1.7	1.43	
100		1.79	1.45	0.724	2.31	2.07	
180		0.442	0.6	0.656	0.336	0.88	
320		0.156	0	0.67	0	0.266	
560		0	0	0	0	0	
1000		0	0	0	0	0	
7d Survival Rate Binomials							
Conc-µg/L	Code	Rep 1	Rep 2	Rep 3	Rep 4	Rep 5	
0	LW	5/5	4/5	4/5	5/5	4/5	
56		4/5	3/5	5/5	5/5	4/5	
100		4/5	4/5	4/5	5/5	5/5	
180		2/5	2/5	2/5	2/5	2/5	
320		1/5	0/5	2/5	0/5	1/5	
560		0/5	0/5	0/5	0/5	0/5	
1000		0/5	0/5	0/5	0/5	0/5	

Chronic Larval Fish Survival and Growth Test

Pacific EcoRisk

Test Type: Growth-Survival (7d)

Organism: Atherinops affinis (Topsmelt)

Material: Copper chloride

Protocol: EPA/600/R-95/136 (1995)

Endpoint: 7d Survival Rate

Source: Reference Toxicant-REF

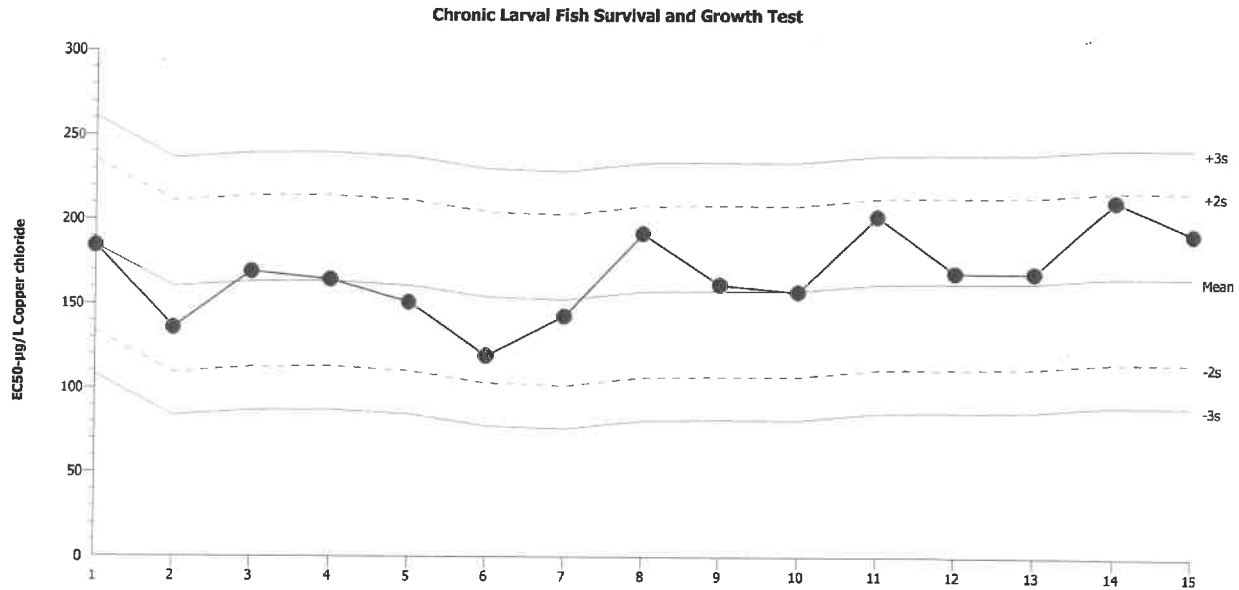

Mean: 166.1 Count: 14 -2s Warning Limit: 115.2 -3s Action Limit: 89.71
 Sigma: 25.46 CV: 15.30% +2s Warning Limit: 217 +3s Action Limit: 242.5

Quality Control Data

Point	Year	Month	Day	Time	QC Data	Delta	Sigma	Warning	Action	Test ID	Analysis ID
1	2016	Dec	1	14:45	184.5	18.41	0.723			09-7939-5083	05-4673-5824
2	2017	Jan	2	12:00	135.5	-30.57	-1.201			12-4511-7385	16-4079-6039
3			2	13:00	169	2.872	0.1128			18-4696-7845	15-3506-1739
4		Mar	21	13:30	164.3	-1.808	-0.071			14-7502-6999	21-3878-4314
5			21	14:30	150.6	-15.49	-0.6084			20-6326-4170	01-2850-5128
6		Apr	27	15:20	118.8	-47.29	-1.858			12-5173-5100	18-2281-7403
7		May	6	15:10	142.4	-23.7	-0.9307			00-9957-1385	04-8504-7742
8		Jun	13	14:20	191.7	25.6	1.006			00-7889-2529	02-3682-4376
9		Jul	13	14:35	161.3	-4.78	-0.1878			17-8123-4418	08-8465-2146
10		Aug	3	15:00	157	-9.113	-0.3579			20-6811-8584	03-9822-6188
11		Oct	12	15:15	201.8	35.71	1.402			00-4593-9500	19-0349-6831
12		Nov	9	15:30	168.5	2.371	0.09311			05-6312-9853	18-7161-6014
13	2018	Feb	15	15:35	168.4	2.281	0.08958			11-8054-5553	18-0166-5915
14			27	17:21	211.5	45.37	1.782			16-6236-6224	01-9640-0272
15		Aug	21	16:01	191.8	25.74	1.011			00-3551-6424	13-5488-9353

Chronic Larval Fish Survival and Growth Test

Pacific EcoRisk

Test Type: Growth-Survival (7d)
 Protocol: EPA/600/R-95/136 (1995)

Organism: Atherinops affinis (Topsmelt)
 Endpoint: Mean Dry Biomass-mg

Material: Copper chloride
 Source: Reference Toxicant-REF

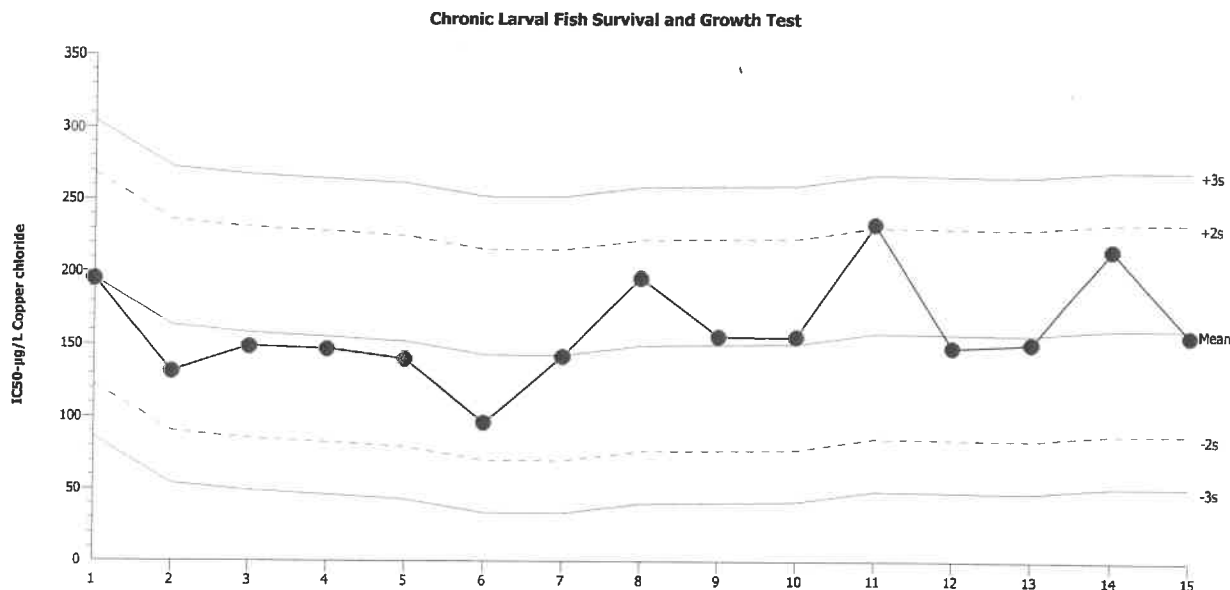

Mean: 160.8 Count: 14 -2s Warning Limit: 88.06 -3s Action Limit: 51.67
 Sigma: 36.39 CV: 22.60% +2s Warning Limit: 233.6 +3s Action Limit: 270

Quality Control Data

Point	Year	Month	Day	Time	QC Data	Delta	Sigma	Warning	Action	Test ID	Analysis ID
1	2016	Dec	1	14:45	195.3	34.55	0.9494			09-7939-5083	07-5754-6003
2	2017	Jan	2	12:00	131.1	-29.72	-0.8166			12-4511-7385	15-6656-2716
3			2	13:00	148.3	-12.5	-0.3434			18-4696-7845	01-2015-2482
4		Mar	21	13:30	146.7	-14.14	-0.3884			14-7502-6999	08-0647-8893
5			21	14:30	139.4	-21.37	-0.5873			20-6326-4170	03-3854-1324
6		Apr	27	15:20	95.92	-64.88	-1.783			12-5173-5100	15-1911-6681
7		May	6	15:10	141.6	-19.23	-0.5284			00-9957-1385	17-5803-8095
8		Jun	13	14:20	195.6	34.78	0.9557			00-7889-2529	14-9330-6229
9		Jul	13	14:35	155.5	-5.33	-0.1465			17-8123-4418	15-5385-4800
10		Aug	3	15:00	155.4	-5.431	-0.1492			20-6811-8584	15-9739-7007
11		Oct	12	15:15	233.1	72.31	1.987			00-4593-9500	13-4527-3547
12		Nov	9	15:30	147.9	-12.94	-0.3556			05-6312-9853	20-2765-5437
13	2018	Feb	15	15:35	150.7	-10.11	-0.2778			11-8054-5553	01-8976-9291
14			27	17:21	215.4	54.6	1.5			16-6236-6224	10-5519-5225
15		Aug	21	16:01	156.3	-4.452	-0.1224			00-3551-6424	11-2151-1794

7 Day Chronic Topsmelt (*A. affinis*) Reference Toxicant Test Data

Client: Reference Toxicant
 Test Material: Copper (as cupric chloride)
 Test ID#: 79324 Project #: 29194
 Test Date: 8/21/18 Randomization: 5.7.2

Organism Log#: 11143 Age: 14 days
 Organism Supplier: Aquatic Biosystems
 Control/Diluent: Filtered Seawater
 Control Water Batch: -

Treatment (µg/L Cu)	Temp (°C)	pH		D.O. (mg/L)		Salinity (ppt)		# Live Organisms					SIGN-OFF
		new	old	new	old	new	old	A	B	C	D	E	
Lab Water Control	20.1	7.90		7.6		33.6		5	5	5	5	5	Date: 8/21/18
56	20.1	7.91		7.5		33.8		5	5	5	5	5	RT Stock Batch #: 5
100	20.0	7.90		7.4		33.6		5	5	5	5	5	Test Solution Prep: EP
180	20.1	7.90		7.5		33.8		5	5	5	5	5	New WQ: DH
320	20.1	7.88		7.5		33.3		5	5	5	5	5	Initiation Time: 1601
560	20.1	7.89		7.5		33.6		5	5	5	5	5	Initiation Signoff: EP
1000	20.1	7.87		7.5		33.5		5	5	5	5	5	
Meter ID:	110A	PH24		RD11		EC11							
Lab Water Control	20.6	7.89	7.49	7.8	5.4	34.2	34.6	5	5	5	5	5	Date: 8/22/18
56	20.6	7.89	7.63	7.9	6.0	34.1	35.0	5	5	5	5	5	RT Stock Batch #: 5
100	20.5	7.84	7.64	8.0	6.1	34.1	34.8	5	5	5	5	5	Test Solution Prep: NJB
180	20.2	7.89	7.70	8.0	6.6	34.1	35.0	5	5	5	4	5	New WQ: JM
320	20.3	7.88	7.68	7.9	6.4	34.0	34.7	3	2	4	4	4	Renewal Time: 1505
560	20.2	7.88	7.71	7.9	6.5	34.0	35.1	0	0	0	0	0	Renewal-Sign-off: ER
1000	19.6	7.86	7.72	8.0	6.7	33.9	35.5	0	0	0	0	0	Old WQ: JR
Meter ID:	100A	PH25	PH15	RD10	RD10	EC10	EC10						
Lab Water Control	20.7	7.94	7.79	8.9	6.8	33.5	34.2	5	5	5	5	5	Date: 8/23/18
56	20.5	7.97	7.80	9.2	6.7	33.6	34.4	5	5	5	5	5	RT Stock Batch #: 5
100	20.4	7.97	7.79	9.3	6.7	33.7	34.4	4	5	5	5	5	Test Solution Prep: CD
180	20.4	7.96	7.77	9.3	6.6	33.5	34.6	5	4	4	4	4	New WQ: TA
320	20.5	7.95	7.80	9.3	6.6	33.6	34.3	3	0	3	4	4	Renewal Time: 1050
560	-	-	-	-	-	-	-	-	-	-	-	-	Renewal-Sign-off: LZ
1000	-	-	-	-	-	-	-	-	-	-	-	-	Old WQ: SPTB
Meter ID:	81A	PH24	PH25	RD10	RD10	EC10	EC10						
Lab Water Control	19.9	7.44	7.81	9.1	6.4	33.5	34.1	5	5	5	5	5	Date: 8/24/18
56	19.6	8.03	7.85	8.1	6.5	33.3	34.3	5	5	5	5	4	RT Stock Batch #: 5
100	19.3	8.05	7.83	9.1	6.5	33.6	34.1	4	4	5	5	5	Test Solution Prep: RG
180	19.3	8.05	7.87	9.0	6.6	33.4	34.5	3	2	3	3	3	New WQ: FT
320	19.3	8.03	7.83	9.0	6.5	33.6	34.4	2	-	3	2	3	Renewal Time: 1015
560	-	-	-	-	-	-	-	-	-	-	-	-	Renewal-Sign-off: RL
1000	-	-	-	-	-	-	-	-	-	-	-	-	Old WQ: TA
Meter ID:	81A	PH19	PH25	RD11	RD10	EC12	EC10						

7 Day Chronic Topsmelt (*A. affinis*) Reference Toxicant Test Data

Client: Reference Toxicant
 Test Material: Copper (as cupric chloride)
 Test ID#: 79324 Project #: 29194
 Test Date: 8/21/18 Randomization: 5.7.2

Organism Log#: 11143 Age: 14 days
 Organism Supplier: Aquatic Biosystems
 Control/Diluent: Filtered Seawater
 Control Water Batch: -

Treatment (µg/L Cu)	Temp (°C)	pH		D.O. (mg/L)		Salinity (ppt)		# Live Organisms					SIGN-OFF
		new	old	new	old	new	old	A	B	C	D	E	
Lab Water Control	20.0	7.86	7.77	8.6	6.6	32.6	34.4	5	5	5	5	5	Date: 8/25/18
56	19.8	7.87	7.84	8.7	6.7	33.0	34.6	5	5	5	5	4	RT Stock Batch #: 5
100	19.9	7.87	7.77	8.7	6.7	33.0	34.6	4	4	5	5	5	Test Solution Prep: TK
180	19.7	7.88	7.81	8.8	6.7	33.2	34.4	3	2	3	2	3	New WQ: AR
320	19.6	7.89	7.85	9.0	6.8	32.3	34.6	1	-	3	1	2	Renewal Time: 1127
560	-	-	-	-	-	-	-	-	-	-	-	-	Renewal-Sign-off: TK
1000	-	-	-	-	-	-	-	-	-	-	-	-	Old WQ: RAP
Meter ID:	40A	PH25	PH24	RD11	RD10	EC11	EC10						
Lab Water Control	20.0	7.93	7.75	8.6	6.3	32.5	34.1	5	5	5	5	5	Date: 8/26/18
56	19.9	7.96	7.71	8.7	6.2	33.1	34.0	4	5	5	5	4	RT Stock Batch #: 5
100	19.8	7.97	7.76	8.7	6.3	33.0	34.1	4	4	5	5	5	Test Solution Prep: TK
180	19.7	7.97	7.83	8.7	6.5	33.1	34.1	3	2	3	2	2	New WQ: FT
320	19.7	7.98	7.85	8.9	6.8	32.9	34.0	1	-	3	0	1	Renewal Time: 1100
560	-	-	-	-	-	-	-	-	-	-	-	-	Renewal-Sign-off: TK
1000	-	-	-	-	-	-	-	-	-	-	-	-	Old WQ: MYL
Meter ID:	40A	PH24	PH25	RD11	RD12	EC13	EC12						
Lab Water Control	20.3	7.88	7.70	8.0	6.4	33.7	34.1	5	4	4	5	4	Date: 8/27/18
56	20.5	7.88	7.75	8.1	6.5	33.7	34.4	4	4	5	5	4	RT Stock Batch #: 5
100	20.7	7.88	7.74	8.1	6.5	33.6	34.1	4	4	4	5	5	Test Solution Prep: JL
180	20.5	7.87	7.85	7.8	6.7	33.5	34.3	2	2	3	2	2	New WQ: DM
320	20.6	7.87	7.84	8.0	6.7	33.7	34.3	1	-	2	-	1	Renewal Time: 1520
560	-	-	-	-	-	-	-	-	-	-	-	-	Renewal-Sign-off: SF
1000	-	-	-	-	-	-	-	-	-	-	-	-	Old WQ: DM
Meter ID:	81A	PH25	PH25	RD11	RD11	EC11	EC11						
Lab Water Control	20.5		7.76		6.5		34.3	5	4	4	5	4	Date: 8/28/18
56	20.4		7.83		6.4		34.5	4	3	5	5	4	Termination Time: 0855
100	20.5		7.83		6.3		34.4	4	4	4	5	5	Termination Sign-off: EP
180	20.7		7.91		6.7		34.3	2	2	2	2	2	Old WQ: DM
320	20.5		7.81		6.2		34.3	1	-	2	-	1	
560	-		-		-		-	-	-	-	-	-	
1000	-		-		-		-	-	-	-	-	-	
Meter ID:	81A		PH25		RD10		EC10						

Topsmelt (A. affinis) Dry Weight Data Sheet

Client: Reference Toxicant Test ID #: 79324 Project # 29194
 Test Material: Copper (as cupric chloride) Tare Weight Date: 8/25/18 Sign-off: RAI
 Test Date: 8/21/18 Final Weight Date: 8/29/18 Sign-off: STB

Pan ID	Concentration	Replicate	Initial Pan Weight (mg)	Final Pan Weight (mg)	Initial # of Organisms	Biomass Value (mg)
1	Control	A	415.47	427.20	5	2.346
2		B	418.14	426.15	5	1.602
3		C	415.36	421.04	5	1.136
4		D	416.09	425.82	5	1.946
5		E	415.75	424.62	5	1.768
6	56	A	417.50 414.73	422.92	5	1.638
7		B	417.50	424.14	5	1.268
8		C	418.30	434.53	5	3.246
9		D	419.80	428.32	5	1.704
10		E	414.73 413.87	421.00	5	1.426
11	100	A	414.89	423.86	5	1.794
12		B	409.30	416.62	5	1.448
13		C	407.75	411.37	5	0.724
14		D	418.52	430.08	5	2.312
15		E	408.02	418.36	5	2.068
16	180	A	405.09	407.30	5	0.442
17		B	417.92	420.92	5	0.600
18		C	413.51	416.79	5	0.656
19		D	410.23	411.91	5	0.336
20		E	401.74	406.14	5	0.880
21	320	A	405.66	406.64	5	0.156
22		B	404.50	—	5	—
23		C	408.13	411.48	5	0.670
24		D	405.00	—	5	—
25		E	417.74	416.07	5	0.266
26	560	A	408.77	—	5	—
27		B	404.77	—	5	—
28		C	406.79	—	5	—
29		D	407.63	—	5	—
30		E	415.59	—	5	—
31	1000	A	409.60	—	5	—
32		B	405.36	—	5	—
33		C	404.71	—	5	—
34		D	403.29	—	5	—
35		E	415.23	—	5	—
QA1			401.13	401.11		
QA2			409.75	409.73		
QA3			413.79	413.79		
Balance ID:			Bal04	Bal04		



Regina Thill
Crescent City Water Quality Control Laboratory
377 J Street
Crescent City, CA 95531

September 9, 2019

Regina:

I have enclosed our report “Chronic Toxicity Testing of Crescent City Wastewater Treatment Plant Effluent” for the effluent samples collected August 19, 21, and 23, 2019. The results of this test are summarized below.

Chronic Toxicity of Crescent City Effluent to *Atherinops affinis*

There were no reductions in survival or growth; the TST analysis resulted in a pass for both endpoints.

If you have any questions regarding this testing, please feel free to call me at (707) 207-7760.

Regards,

Stevi Vasquez
Project Manager



Pacific EcoRisk is accredited in accordance with NELAP (ORELAP ID 4043). Pacific EcoRisk certifies that the test results reported herein conform to the most current NELAP requirements for parameters for which accreditation is required and available. Any exceptions to NELAP requirements are noted, where applicable, in the body of the report. This report shall not be reproduced, except in full, without the written consent of Pacific EcoRisk. This testing was performed under Lab Order 30664.

Chronic Toxicity Testing of Crescent City Wastewater Treatment Plant Effluent

Samples collected August 19, 21, and 23, 2019

Performed For

City of Crescent City
Water Quality Control Laboratory
377 J Street
Crescent City, CA 95531-4025

Prepared By

Pacific EcoRisk, Inc.
2250 Cordelia Road
Fairfield, CA 94534

September 2019



Chronic Toxicity Testing of Crescent City Wastewater Treatment Plant Effluent

Samples collected August 19, 21, and 23, 2019

Table of Contents

	Page
1. INTRODUCTION	1
2. TOXICITY TEST PROCEDURES	1
2.1 Sample Receipt and Handling.....	1
2.2 Chronic Toxicity Testing with <i>Atherinops affinis</i>	1
2.3 Reference Toxicant Testing of the <i>Atherinops affinis</i>	2
3. RESULTS	3
3.1 Chronic Toxicity of Crescent City Effluent to <i>Atherinops affinis</i>	3
3.2 Reference Toxicant Toxicity to <i>Atherinops affinis</i>	3
4. SUMMARY AND CONCLUSIONS	4
4.1 QA/QC Summary	4

Appendices

Appendix A Chain-of-Custody Records for the Collection and Delivery of the Samples

Appendix B Test Data and Summary of Statistics for the Evaluation of the Chronic Toxicity of Crescent City Effluent to *Atherinops affinis*

Appendix C Test Data and Summary of Statistics for the Reference Toxicant Evaluation of the *Atherinops affinis*



1. INTRODUCTION

The City of Crescent City has contracted Pacific EcoRisk (PER) to perform an evaluation of the chronic toxicity of Crescent City Wastewater Treatment Plant (Crescent City) effluent. This evaluation consisted of performing the EPA chronic toxicity test with topsmelt (*Atherinops affinis*) using effluent samples that were collected on August 19, 21, and 23, 2019. In order to assess the sensitivity of the test organisms to toxic stress, a reference toxicant test was also performed. This report describes the performance and results of these tests.

2. TOXICITY TEST PROCEDURES

The methods used in this testing followed the guidelines established by the EPA manual “Short-Term Methods for Estimating the Chronic Toxicity of Effluents and Receiving Waters to West Coast Marine and Estuarine Organisms” (EPA/600/R-95/136).

2.1 Sample Receipt and Handling

On August 19, 21, and 23, samples of Crescent City effluent were collected into appropriately cleaned sample containers and transported on ice and under chain-of-custody to the PER laboratory in Fairfield, CA. Upon receipt at the laboratory, aliquots of each sample were collected for analysis of initial water quality characteristics (Table 1), with the remainder of the samples being stored at $\leq 6^{\circ}\text{C}$, except when being used to prepare test solutions. The chain-of-custody records for the collection and delivery of the samples are presented in Appendix A.

Date Sample Received	Sample ID	Temp ($^{\circ}\text{C}$)	pH	D.O (mg/L)	Salinity (ppt)	Conductivity ($\mu\text{S}/\text{cm}$)	Total Ammonia (mg/L N)
8/20/19	EFF-001	1.5	7.28	6.8	0.3	584	7.5
8/22/19	EFF-001	3.0	7.13	7.2	0.4	728	8.1
8/24/19	EFF-001	2.4	7.27	7.5	0.4	692	9.2

2.2 Chronic Toxicity Testing with *Atherinops affinis*

The chronic toxicity test with *Atherinops affinis* consists of exposing larval fish to the effluent for 7 days, after which effects on survival and growth are evaluated. The specific procedures used in this testing are described below.

The larval fish used in these tests were obtained from a commercial supplier (Aquatic Biosystems, Fort Collins, CO). Upon receipt at the testing lab, the larval fish were maintained in a tank containing Lab Water Control medium. The fish were fed brine shrimp nauplii *ad libitum* during the pre-test holding period.



The Lab Water Control medium for these tests consisted of 1 µm filtered seawater (U.C. Granite Canyon Marine Laboratory, CA). The Lab Water Control medium and effluent were used to prepare test solutions at a single test treatment concentration of 3.45% effluent. Routine water quality characteristics (pH, D.O., and salinity) were measured for each test solution prior to use in these tests.

There were five replicates for each test treatment, each replicate consisting of 200 mL of test solution in a 600-mL glass beaker. The tests were initiated by randomly allocating five 14-day old topsmelt into each replicate beaker. The beakers were randomly positioned in a temperature-controlled room at 20°C, under a 16L:8D photoperiod. These test fish were fed brine shrimp nauplii twice daily.

Each day of the tests, fresh test solutions were prepared as before. The test replicate beakers were examined, with any dead animals, uneaten food, wastes, and other detritus being removed. The number of live fish in each replicate was determined and then approximately 80% of the test media in each beaker was carefully poured out and replaced with fresh media. “Old” water quality characteristics (pH and D.O.) were measured on the old test water collected from one randomly selected replicate at each treatment. The test beakers were then placed back into the temperature-controlled room.

After 7 days exposure, the tests were terminated and the number of live fish in each replicate beaker was recorded. The fish from each replicate were then carefully euthanized in methanol, rinsed in de-ionized water, and transferred to a pre-dried and pre-tared weighing pan. The fish were then dried at 100°C for ≥24 hours and re-weighed to determine the total weight of fish in each replicate. The total weight was then divided by the initial number of fish per replicate to determine the biomass value. The resulting survival and biomass value data were analyzed to determine any impairment(s) caused by the effluent. All statistical analyses were performed using CETIS® (Tidepool Scientific Software, McKinleyville, CA).

2.3 Reference Toxicant Testing of the *Atherinops affinis*

The reference toxicant test was performed similarly to the effluent test, but used test solutions consisting of Lab Water Control medium spiked with copper chloride at concentrations of 56, 100, 180, 320, 560, and 1000 µg Cu/L. The resulting test response data were analyzed to determine key dose-response point estimates. All statistical analyses were made using CETIS. These response endpoints were then compared to the typical response ranges established by the mean ± 2 SD of the point estimates generated by the most recent previous reference toxicant tests performed by this lab.



3. RESULTS

3.1 Chronic Toxicity of Crescent City Effluent to *Atherinops affinis*

The results of this test are summarized in Table 2. There were no reductions in survival or growth; the TST analysis resulted in a pass for both endpoints. The test data and summary of statistics for this test are presented in Appendix B.

Table 2. Chronic toxicity of Crescent City effluent to <i>Atherinops affinis</i> .		
Effluent Treatment	Mean % Survival	Mean Biomass Value (mg)
Lab Water Control	92	1.99
3.45%	92	1.74
Summary of Statistics		
Percent (%) Effect =	No reduction	12.3%
TST Analysis =	Pass	Pass

3.2 Reference Toxicant Toxicity to *Atherinops affinis*

The results of this test are summarized in Table 3. The EC₅₀ and IC₅₀ for this test were consistent with the typical response ranges established by the reference toxicant test database for this species, indicating that the organisms were responding to toxic stress in a typical fashion. The test data and summary of statistics for this test are presented in Appendix C.

Table 3. Reference toxicant testing: Effects of CuCl ₂ on <i>Atherinops affinis</i> .		
Cu Concentration (µg/L)	Mean % Survival	Mean Biomass Value (mg)
Lab Water Control	92	1.50
56	88	1.45
100	92	1.51
180	32*	0.47
320	8*	0.07
560	0*	-
1000	0*	-
Summary of Statistics		
Survival EC ₅₀ or Growth IC ₅₀ =	172 µg/L CuCl ₂	158 µg/L CuCl ₂

* The response at this test treatment was significantly less than the Lab Water Control treatment response ($p < 0.05$).



4. SUMMARY AND CONCLUSIONS

An evaluation of the chronic toxicity of Crescent City effluent was performed using effluent samples collected August 19, 21, and 23, 2019. The results of this test are summarized below.

Chronic Toxicity of Crescent City Effluent to *Atherinops affinis*

There were no reductions in survival or growth; the TST analysis resulted in a pass for both endpoints.

4.1 QA/QC Summary

Test Conditions – Test conditions (pH, D.O., temperature, etc.) were within acceptable limits. All analyses were performed according to laboratory Standard Operating Procedures.

Negative Control – The biological response of the Lab Control treatments were within acceptable limits.

Positive Control – The results of the reference toxicant test were consistent with the typical response ranges established by the reference toxicant test database for this species, indicating that the test organisms were responding to toxicant stress in a typical and consistent fashion.

Concentration Response Relationships – The concentration-response relationship for the reference toxicant test was evaluated per EPA guidelines (EPA-821-B-00-004) and was determined to be acceptable.



Appendix A

Chain-of-Custody Records for the Collection and Delivery of the Samples



Pacific EcoRisk
 2250 Cordelia Rd., Fairfield, CA 94534
 (707) 207-7760 FAX (707) 207-7916

CHAIN-OF-CUSTODY RECORD

Results To: Crescent City Water Quality Control Lab		Invoice To: Same		REQUESTED ANALYSIS																	
Address: 377 J Street Crescent City, CA 95531		Address:																			
Phone: (707) 465-5258		Phone:		Atherinops affinis Survival and Growth, EPA-600-R-95-136																	
Attn: Regina Thill		Attn:																			
E-mail: rthill@crescentcity.org		E-mail:																			
Project Name: Annual Toxicity Testing																					
P.O.#/Ref: 52806																					
Client Sample ID	Sample Date	Sample Time	Sample Matrix*	Grab/Comp	Container		X														
					Number	Type															
1 EFF-001	8/19/19	1305	EFF	Grab	1	1-gal cubitainer															
2																					
3																					
4																					
5																					
6																					
7																					
8																					
9																					
10																					
Samples collected by: Dennis B.																					
Comments/Special Instruction: TRC1 = 0.00 PO = 52806							RELINQUISHED BY:					RECEIVED BY:									
							Signature: <i>[Signature]</i>					Signature: <i>[Signature]</i>									
							Print: Tyson Morecraft					Print: Regina Thill									
							Organization: Jacobs					Organization: CWQL									
							Date: 8-19-19 Time: 1309					Date: 8/19/19 Time: 1309									
							RELINQUISHED BY:					RECEIVED BY:									
							Signature: <i>[Signature]</i>					Signature: <i>[Signature]</i>									
							Print: <i>[Signature]</i>					Print: Ivana Djordjevic									
							Organization: <i>[Signature]</i>					Organization: PER									
							Date: <i>[Signature]</i> Time: <i>[Signature]</i>					Date: 08/20/19 Time: 0926									

*Example Matrix Codes: (EFF - Effluent) (FW = Freshwater); (SW = Saltwater); (WW = Wastewater); (STRMW = Stormwater); (SED = Sediment); or other



Pacific EcoRisk
 2250 Cordelia Rd., Fairfield, CA 94534
 (707) 207-7760 FAX (707) 207-7916

CHAIN-OF-CUSTODY RECORD

Results To: Crescent City Water Quality Control Lab		Invoice To: Same		REQUESTED ANALYSIS																		
Address: 377 J Street Crescent City, CA 95531		Address:																				
Phone: (707) 465-5258		Phone:		Atherinops affinis Survival and Growth, EPA-600-R-95-136																		
Attn: Regina Thill		Attn:																				
E-mail: rthill@crescentcity.org		E-mail:																				
Project Name: Annual Toxicity Testing																						
P.O.#/Ref: 52806																						
Client Sample ID	Sample Date	Sample Time	Sample Matrix*	Grab/Comp	Container		X															
					Number	Type																
1 EFF-001	8/21/19	1314	EFF	Grab	1	1-gal cubitainer	X															
2																						
3																						
4																						
5																						
6																						
7																						
8																						
9																						
10																						
Samples collected by: Tyson Morecraft																						
Comments/Special Instruction: TRC1 = 0.00 PO = 52806							RELINQUISHED BY:					RECEIVED BY:										
							Signature: <i>[Signature]</i>					Signature: <i>[Signature]</i>										
							Print: Tyson Morecraft					Print: Regina Goudgame Thill										
							Organization: Jacobs					Organization: CWQL										
							Date: 8-21-19 Time: 1316					Date: 8/21/19 Time: 1317										
							RELINQUISHED BY:					RECEIVED BY:										
							Signature: <i>[Signature]</i>					Signature: <i>[Signature]</i>										
							Print: <i>[Signature]</i>					Print: Sam Boykin										
							Organization: <i>[Signature]</i>					Organization: PER 573										
							Date: <i>[Signature]</i> Time: <i>[Signature]</i>					Date: 8/22/19 Time: 1100										

*Example Matrix Codes: (EFF - Effluent) (FW = Freshwater); (SW = Saltwater); (WW = Wastewater); (STRMW = Stormwater); (SED = Sediment); or other

Appendix B

Test Data and Summary of Statistics for the Evaluation of the Chronic Toxicity of Crescent City Effluent to *Atherinops affinis*



CETIS Summary Report

Report Date: 31 Aug-19 07:55 (p 1 of 1)
 Test Code/ID: 84592 / 19-4619-0729

Chronic Larval Fish Survival and Growth Test **Pacific EcoRisk**

Batch ID: 04-2748-9855	Test Type: Growth-Survival (7d)	Analyst: Ashleigh Findley
Start Date: 20 Aug-19 15:14	Protocol: EPA/600/R-95/136 (1995)	Diluent: Filtered Seawater
Ending Date: 27 Aug-19 06:29	Species: Atherinops affinis	Brine: Crystal Sea
Test Length: 6d 15h	Taxon: Actinopterygii	Source: Aquatic Biosystems, CO Age: 14

Sample ID: 12-4714-2003	Code: EFF	Project: 30664
Sample Date: 19 Aug-19 13:05	Material: Effluent	Source: City of Crescent City
Receipt Date: 20 Aug-19 09:26	CAS (PC):	Station: EFF-001
Sample Age: 26h (1.5 °C)	Client: Crescent City	

Single Comparison Summary					
Analysis ID	Endpoint	Comparison Method	P-Value	Comparison Result	S
04-9456-9641	7d Survival Rate	TST-Welch's t Test	0.0055	3.45% passed 7d survival rate	1
14-5257-4826	Mean Dry Biomass-mg	TST-Welch's t Test	0.1901	3.45% passed mean dry biomass-mg	1

7d Survival Rate Summary											
Conc-%	Code	Count	Mean	95% LCL	95% UCL	Min	Max	Std Err	Std Dev	CV%	%Effect
0	LW	5	0.920	0.698	1.000	0.600	1.000	0.080	0.179	19.44%	0.00%
3.45		5	0.920	0.784	1.000	0.800	1.000	0.049	0.110	11.91%	0.00%

Mean Dry Biomass-mg Summary											
Conc-%	Code	Count	Mean	95% LCL	95% UCL	Min	Max	Std Err	Std Dev	CV%	%Effect
0	LW	5	1.99	1.09	2.88	0.736	2.55	0.322	0.72	36.24%	0.00%
3.45		5	1.74	1.46	2.02	1.45	2.03	0.102	0.227	13.03%	12.32%

7d Survival Rate Detail						
Conc-%	Code	Rep 1	Rep 2	Rep 3	Rep 4	Rep 5
0	LW	1.000	0.600	1.000	1.000	1.000
3.45		0.800	1.000	0.800	1.000	1.000

Mean Dry Biomass-mg Detail						
Conc-%	Code	Rep 1	Rep 2	Rep 3	Rep 4	Rep 5
0	LW	2.55	0.736	2.17	2.12	2.37
3.45		1.45	1.69	1.64	1.9	2.03

7d Survival Rate Binomials						
Conc-%	Code	Rep 1	Rep 2	Rep 3	Rep 4	Rep 5
0	LW	5/5	3/5	5/5	5/5	5/5
3.45		4/5	5/5	4/5	5/5	5/5

CETIS Analytical Report

Report Date: 31 Aug-19 07:55 (p 1 of 2)
 Test Code/ID: 84592 / 19-4619-0729

Chronic Larval Fish Survival and Growth Test **Pacific EcoRisk**

Analysis ID: 04-9456-9641 Endpoint: 7d Survival Rate CETIS Version: CETISv1.9.6
 Analyzed: 31 Aug-19 7:54 Analysis: Parametric Bioequivalence-Two Sample Status Level: 1

Data Transform	Alt Hyp	TST_b	Comparison Result
Angular (Corrected)	C*b < T	0.75	3.45% passed 7d survival rate

TST-Welch's t Test

Control	vs	Control II	Test Stat	Critical	DF	P-Type	P-Value	Decision(α:25%)
Lab Water Contr		3.45*	3.43	0.711	7	CDF	0.0055	Non-Significant Effect

ANOVA Table

Source	Sum Squares	Mean Square	DF	F Stat	P-Value	Decision(α:5%)
Between	2.911E-05	2.911E-05	1	0.000984	0.9757	Non-Significant Effect
Error	0.236745	0.0295932	8			
Total	0.236775		9			

ANOVA Assumptions Tests

Attribute	Test	Test Stat	Critical	P-Value	Decision(α:1%)
Variance	Variance Ratio F Test	2.48	23.2	0.4007	Equal Variances
Distribution	Shapiro-Wilk W Normality Test	0.658	0.741	2.8E-04	Non-Normal Distribution

7d Survival Rate Summary

Conc-%	Code	Count	Mean	95% LCL	95% UCL	Median	Min	Max	Std Err	CV%	%Effect
0	LW	5	0.920	0.698	1.000	1.000	0.600	1.000	0.080	19.44%	0.00%
3.45		5	0.920	0.784	1.000	1.000	0.800	1.000	0.049	11.91%	0.00%

Angular (Corrected) Transformed Summary

Conc-%	Code	Count	Mean	95% LCL	95% UCL	Median	Min	Max	Std Err	CV%	%Effect
0	LW	5	1.25	0.998	1.51	1.35	0.886	1.35	0.0918	16.38%	0.00%
3.45		5	1.25	1.09	1.41	1.35	1.11	1.35	0.0583	10.43%	0.27%

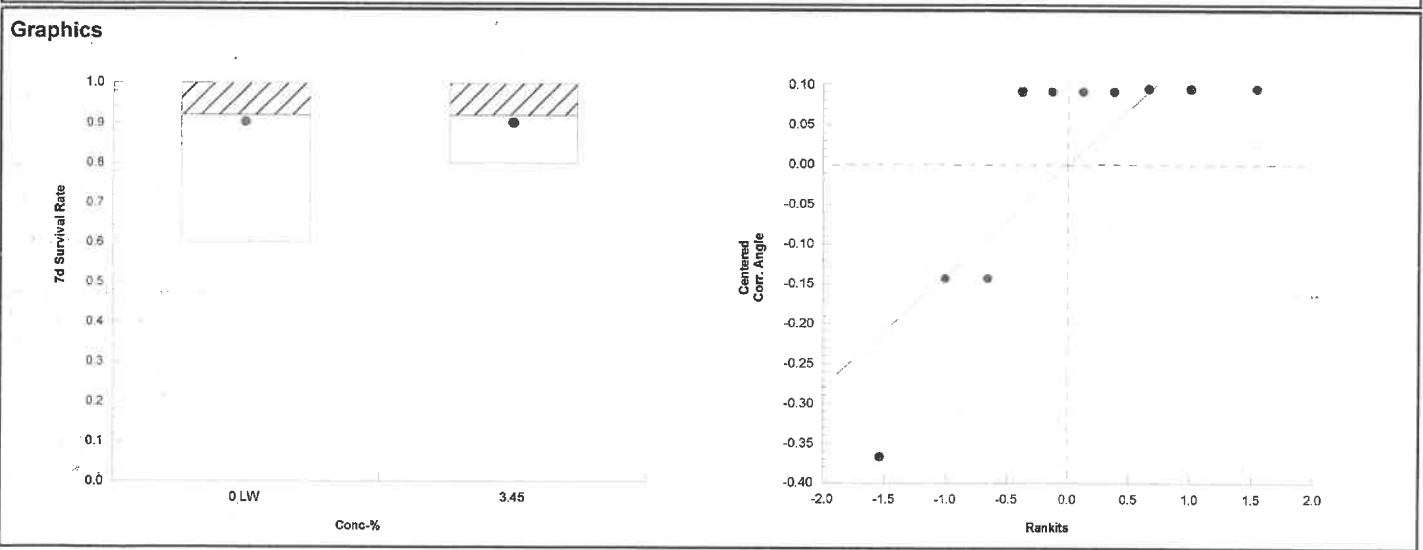

CETIS Analytical Report

Report Date: 31 Aug-19 07:55 (p 2 of 2)
 Test Code/ID: 84592 / 19-4619-0729

Chronic Larval Fish Survival and Growth Test Pacific EcoRisk

Analysis ID: 14-5257-4826 Endpoint: Mean Dry Biomass-mg CETIS Version: CETISv1.9.6
 Analyzed: 31 Aug-19 7:55 Analysis: Parametric Bioequivalence-Two Sample Status Level: 1

Data Transform	Alt Hyp	TST_b	Comparison Result
Untransformed	C*b < T	0.75	3.45% passed mean dry biomass-mg

TST-Welch's t Test

Control	vs	Control II	Test Stat	Critical	DF	P-Type	P-Value	Decision(α:25%)
Lab Water Contr		3.45*	0.962	0.727	5	CDF	0.1901	Non-Significant Effect

ANOVA Table

Source	Sum Squares	Mean Square	DF	F Stat	P-Value	Decision(α:5%)
Between	0.149817	0.149817	1	0.525	0.4893	Non-Significant Effect
Error	2.28207	0.285259	8			
Total	2.43189		9			

ANOVA Assumptions Tests

Attribute	Test	Test Stat	Critical	P-Value	Decision(α:1%)
Variance	Variance Ratio F Test	10.1	23.2	0.0461	Equal Variances
Distribution	Shapiro-Wilk W Normality Test	0.828	0.741	0.0319	Normal Distribution

Mean Dry Biomass-mg Summary

Conc-%	Code	Count	Mean	95% LCL	95% UCL	Median	Min	Max	Std Err	CV%	%Effect
0	LW	5	1.99	1.09	2.88	2.17	0.736	2.55	0.322	36.24%	0.00%
3.45		5	1.74	1.46	2.02	1.69	1.45	2.03	0.102	13.03%	12.32%

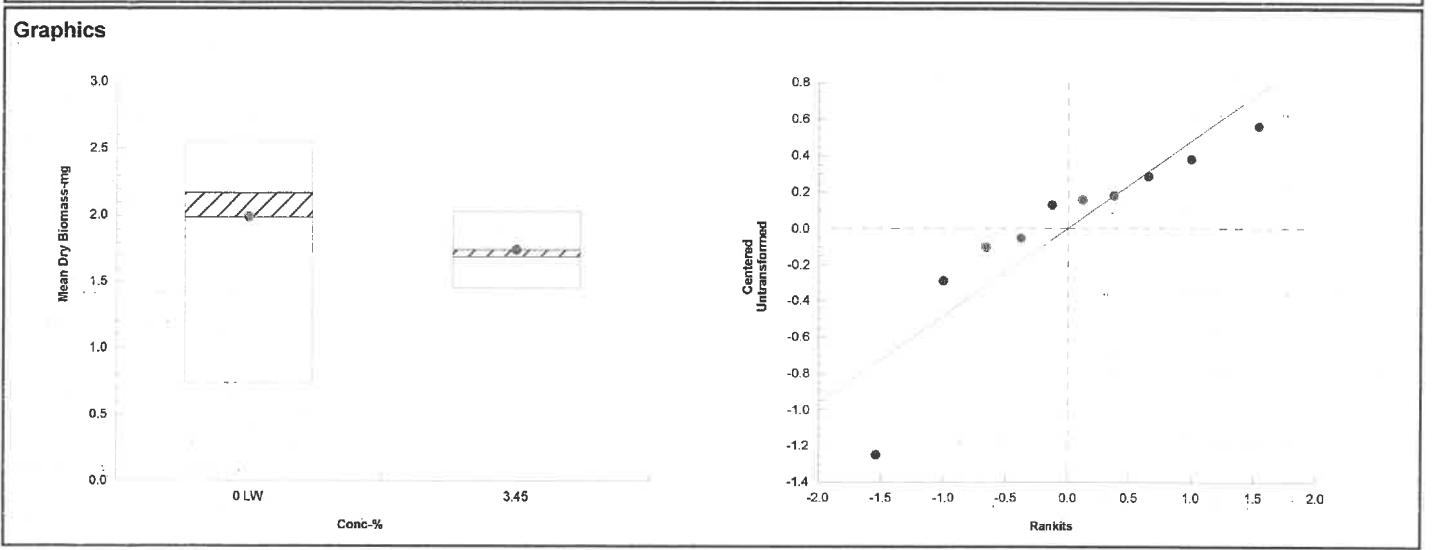

7 Day Chronic Topsmelt (*A. affinis*) Toxicity Test Data

Client: Crescent City
 Test Material: Effluent
 Test ID#: 84592 Project #: 30664
 Test Date: 8/20/19 Randomization: S.2.1

Organism Log#: 11730 Age: 14 DAYS
 Organism Supplier: ABS
 Control Water: Filtered Seawater

Test Treatment	Temp (°C)	pH		D.O. (mg/L)		Salinity (ppt)	# Live Organisms					SIGN-OFF
		new	old	new	old		A	B	C	D	E	
Lab Control	20.5	7.71		7.9		33.5	5	5	5	5	5	Date: 8/20/19 Sample ID: 53618
3.45%	20.6	7.68		7.7		33.0	5	5	5	5	5	Test Solution Prep: SD Initiation Time: 1514
Meter ID	4BA	PH24		RD10		EC10	New WQ: TA					Initiation Signoff: KB
Lab Control	20.3	7.82	7.51	9.5	5.8	33.6	5	5	5	5	5	Date: 8/21/19 Sample ID: 53618
3.45%	20.1	7.83	7.52	9.6	5.9	33.0 32.5 ML 8/21/19	5	5	5	5	5	Test Solution Prep: BL Renewal Time: 1610
Meter ID	59A	PH24	PH26	RD13	RD12	EC13	New WQ: YU		Old WQ: MYL			Renewal Signoff: KL
Lab Control	19.9	7.80	7.67	8.2	6.4	33.0	5	5	5	5	5	Date: 8/22/19 Sample ID: 53651
3.45%	20.0	7.76	7.68	8.6	6.3	32.1	5	5	5	5	5	Test Solution Prep: KB Renewal Time: 1320
Meter ID	97A	PH20	PH24	RD11	RD11	EC14	New WQ: KR		Old WQ: SAT			Renewal Signoff: XY
Lab Control	19.0	7.58	7.57	8.3	6.2	33.1	5	5	5	5	5	Date: 8/23/19 Sample ID: 53651
3.45%	18.8	7.62	7.58	8.4	6.1	32.6	5	5	4	5	5	Test Solution Prep: JL Renewal Time: 1504
Meter ID	93A	PH26	PH26	RD11	RD11	EC11	New WQ: SD		Old WQ: SD			Renewal Signoff: AB
Lab Control	19.8	7.79	7.59	8.4	5.5	33.5	5	5	5	5	5	Date: 8/24/19 Sample ID: 53688
3.45%	19.8	7.80	7.62	8.9	5.6	32.6 32.5 8/24/19	5	5	4	5	5	Test Solution Prep: JL Renewal Time: 1457
Meter ID	99A	PH26	PH24	RD10	RD13	EC10	New WQ: BV		Old WQ: BV			Renewal Signoff: JFF
Lab Control	19.9	7.61	7.70	7.3	6.5	33.3	5	3	5	5	5	Date: 8/25/19 Sample ID: 53688
3.45%	19.8	7.66	7.72	7.3	6.5	32.5 32.5 8/25/19	4	5	4	5	5	Test Solution Prep: KB Renewal Time: 1215
Meter ID	40A	PH24	PH24	RD12	RD12	EC14	New WQ: BV		Old WQ: BV			Renewal Signoff: TR
Lab Control	20.2	7.89	7.83	8.6	5.4	32.0	5	3	5	5	5	Date: 8/26/19 Sample ID: 53688
3.45%	19.9	7.87	7.88	8.9	5.6	32.0	4	5	4	5	5	Test Solution Prep: KB Renewal Time: 1515
Meter ID	4BA	PH24	PH25	RD12	RD10	EC14	New WQ: YU		Old WQ: SP			Renewal Signoff: KB
Lab Control	19.7		7.66		6.0	34.6	5	3	5	5	5	Date: 8/27/19 Termination Time: 0629
3.45%	19.8		7.73		6.1	33.6	4	5	4	5	5	Termination Signoff: KB
Meter ID	4BA		PH24		RD11	EC14			Old WQ: JR			

Chronic Topsmelt Dry Weight and Biomass Data

Client: Crescent City Test ID #: 84592 Project # 30664
 Sample: Effluent Tare Weight Date: 8-22-19 Sign-off: YU
 Test Date: 8/20/19 Final Weight Date: 8/28/19 Sign-off: JK

Pan ID	Concentration	Replicate	Initial Pan Weight (mg)	Final Pan Weight (mg)	Initial # of Organisms	Biomass Value (mg)
1	Control	A	407.11	419.85	5	2.55
2		B	415.61	419.29	5	0.736
3		C	411.16	422.00	5	2.17
4		D	406.72	417.30	5	2.12
5		E	411.67	423.52	5	2.37
6	3.45%	A	413.33	420.59	5	1.45
7		B	414.22	422.67	5	1.69
8		C	415.26	423.46	5	1.67
9		D	415.32	424.82	5	1.90
10		E	405.30	415.46	5	2.03
QA 1			410.73	410.79		
Balance ID			BAL04	BAL04		

Appendix C

Test Data and Summary of Statistics for the Reference Toxicant Evaluation of the *Atherinops affinis*

CETIS Summary Report

Report Date: 30 Aug-19 11:10 (p 1 of 2)
 Test Code/ID: 84593 / 15-4480-3505

Chronic Larval Fish Survival and Growth Test						Pacific EcoRisk
Batch ID: 05-8781-5452	Test Type: Growth-Survival (7d)	Analyst: Ashleigh Findley				
Start Date: 13 Aug-19 15:30	Protocol: EPA/600/R-95/136 (1995)	Diluent: Filtered Seawater				
Ending Date: 20 Aug-19 08:35	Species: Atherinops affinis	Brine: Not Applicable				
Test Length: 6d 17h	Taxon: Actinopterygii	Source: Aquatic Biosystems, CO	Age: 14			
Sample ID: 03-2351-8118	Code: CuCl2	Project: 30677				
Sample Date: 13 Aug-19 15:30	Material: Copper chloride	Source: Reference Toxicant				
Receipt Date: 13 Aug-19 15:30	CAS (PC):	Station: In House				
Sample Age: n/a (20 °C)	Client: Pacific Ecorisk					

Multiple Comparison Summary							
Analysis ID	Endpoint	Comparison Method	✓ NOEL	LOEL	TOEL	TU	PMSD S
04-7571-3246	7d Survival Rate	Dunnett Multiple Comparison Test	✓ 100	180	134.2		21.7% 1
15-3522-0862	Mean Dry Biomass-mg	Dunnett Multiple Comparison Test	✓ 100	180	134.2		29.8% 1

Point Estimate Summary							
Analysis ID	Endpoint	Point Estimate Method	✓ Level	µg/L	95% LCL	95% UCL	TU S
05-7166-6556	7d Survival Rate	GLM: Log-Normal (Probit)	✓ EC1	71.9	30.1	102	1
			✓ EC5	92.8	47.6	122	
			✓ EC10	106	60.6	135	
			EC15	117	71.2	145	
			EC20	126	80.9	154	
			EC25	134	90	162	
			EC40	157	117	185	
			EC50	172	135	203	
18-1213-2008	Mean Dry Biomass-mg	Linear Interpolation (ICPIN)	IC5	104	n/a	111	1
			IC10	110	n/a	121	
			✓ IC15	116	1.62	131	
			✓ IC20	122	18.5	141	
			✓ IC25	128	92.5	153	
			✓ IC40	146	118	184	
			✓ IC50	158	130	213	

7d Survival Rate Summary											
Conc-µg/L	Code	Count	Mean	95% LCL	95% UCL	Min	Max	Std Err	Std Dev	CV%	%Effect
0	LW	5	0.920	0.784	1.000	0.800	1.000	0.049	0.110	11.91%	0.00%
56		5	0.880	0.744	1.000	0.800	1.000	0.049	0.110	12.45%	4.35%
100		5	0.920	0.784	1.000	0.800	1.000	0.049	0.110	11.91%	0.00%
180		5	0.320	0.037	0.603	0.000	0.600	0.102	0.228	71.26%	65.22%
320		5	0.080	0.000	0.216	0.000	0.200	0.049	0.110	136.93%	91.30%
560		5	0.000	0.000	0.000	0.000	0.000	0.000	0.000		100.00%
1000		5	0.000	0.000	0.000	0.000	0.000	0.000	0.000		100.00%

Mean Dry Biomass-mg Summary											
Conc-µg/L	Code	Count	Mean	95% LCL	95% UCL	Min	Max	Std Err	Std Dev	CV%	%Effect
0	LW	5	1.5	0.924	2.08	0.992	2.15	0.209	0.467	31.03%	0.00%
56		5	1.45	1.21	1.69	1.11	1.56	0.0864	0.193	13.35%	3.72%
100		5	1.51	1.33	1.7	1.32	1.73	0.0669	0.15	9.89%	-0.59%
180		5	0.472	-0.0634	1.01	0	1.15	0.193	0.432	91.35%	68.58%
320		5	0.0676	-0.0475	0.183	0	0.176	0.0415	0.0927	137.13%	95.50%
560		5	0	0	0	0	0	0	0		100.00%
1000		5	0	0	0	0	0	0	0		100.00%

CETIS Summary Report

Report Date: 30 Aug-19 11:10 (p 2 of 2)
 Test Code/ID: 84593 / 15-4480-3505

Chronic Larval Fish Survival and Growth Test							Pacific EcoRisk
7d Survival Rate Detail							
Conc-µg/L	Code	Rep 1	Rep 2	Rep 3	Rep 4	Rep 5	
0	LW	0.800	1.000	1.000	0.800	1.000	
56		1.000	0.800	1.000	0.800	0.800	
100		0.800	0.800	1.000	1.000	1.000	
180		0.400	0.400	0.200	0.000	0.600	
320		0.200	0.000	0.200	0.000	0.000	
560		0.000	0.000	0.000	0.000	0.000	
1000		0.000	0.000	0.000	0.000	0.000	
Mean Dry Biomass-mg Detail							
Conc-µg/L	Code	Rep 1	Rep 2	Rep 3	Rep 4	Rep 5	
0	LW	0.992	1.81	2.15	1.24	1.33	
56		1.11	1.56	1.56	1.49	1.52	
100		1.32	1.5	1.46	1.73	1.56	
180		0.482	0.22	0.512	0	1.15	
320		0.162	0	0.176	0	0	
560		0	0	0	0	0	
1000		0	0	0	0	0	
7d Survival Rate Binomials							
Conc-µg/L	Code	Rep 1	Rep 2	Rep 3	Rep 4	Rep 5	
0	LW	4/5	5/5	5/5	4/5	5/5	
56		5/5	4/5	5/5	4/5	4/5	
100		4/5	4/5	5/5	5/5	5/5	
180		2/5	2/5	1/5	0/5	3/5	
320		1/5	0/5	1/5	0/5	0/5	
560		0/5	0/5	0/5	0/5	0/5	
1000		0/5	0/5	0/5	0/5	0/5	

Chronic Larval Fish Survival and Growth Test

Pacific EcoRisk

Test Type: Growth-Survival (7d)
 Protocol: EPA/600/R-95/136 (1995)

Organism: Atherinops affinis (Topsmelt)
 Endpoint: 7d Survival Rate

Material: Copper chloride
 Source: Reference Toxicant-REF

Chronic Larval Fish Survival and Growth Test

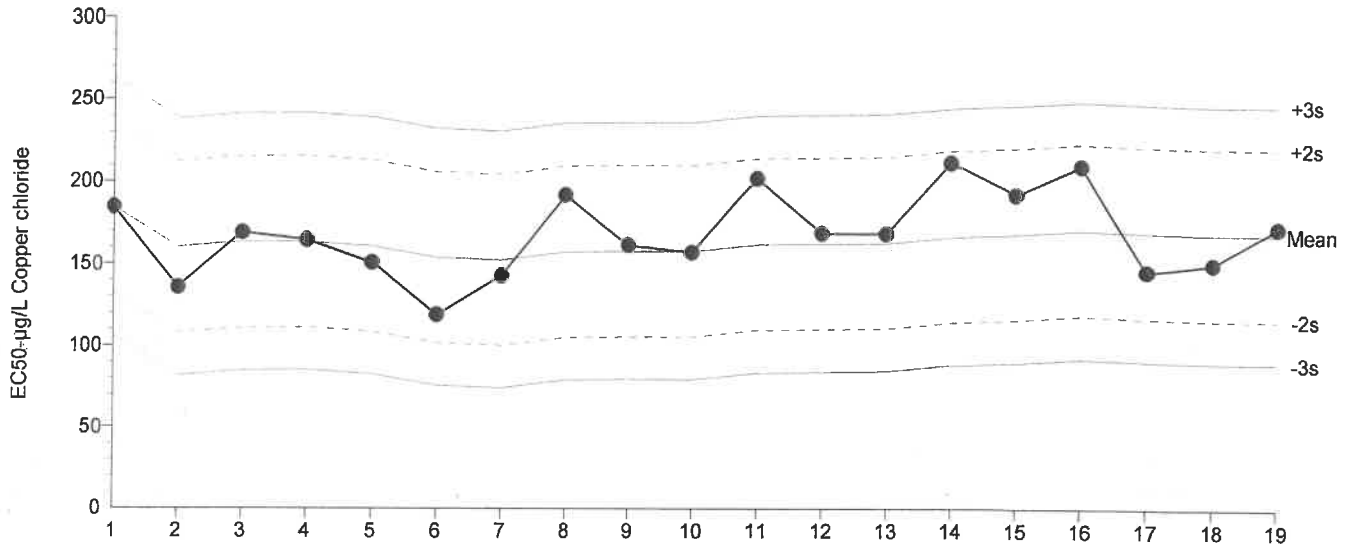

Mean: 167.9 Count: 18 -2s Warning Limit: 115.7 -3s Action Limit: 89.56
 Sigma: 26.11 CV: 15.60% +2s Warning Limit: 220.1 +3s Action Limit: 246.2

Quality Control Data

Point	Year	Month	Day	Time	QC Data	Delta	Sigma	Warning	Action	Test ID	Analysis ID
1	2016	Dec	1	14:45	184.5	16.61	0.636			09-7939-5083	05-4673-5824
2	2017	Jan	2	12:00	135.5	-32.37	-1.24			12-4511-7385	16-4079-6039
3			2	13:00	169	1.072	0.04108			18-4696-7845	07-5331-9436
4		Mar	21	13:30	164.3	-3.608	-0.1382			14-7502-6999	21-3878-4314
5			21	14:30	150.6	-17.29	-0.6622			20-6326-4170	01-2850-5128
6		Apr	27	15:20	118.8	-49.09	-1.88			12-5173-5100	18-2281-7403
7		May	6	15:10	142.4	-25.5	-0.9765			00-9957-1385	04-8504-7742
8		Jun	13	14:20	191.7	23.8	0.9116			00-7889-2529	02-3682-4376
9		Jul	13	14:35	161.3	-6.58	-0.252			17-8123-4418	08-8465-2146
10		Aug	3	15:00	157	-10.91	-0.418			20-6811-8584	03-9822-6188
11		Oct	12	15:15	201.8	33.91	1.299			00-4593-9500	19-0349-6831
12		Nov	9	15:30	168.5	0.5706	0.02185			05-6312-9853	18-7161-6014
13	2018	Feb	15	15:35	168.4	0.4806	0.01841			11-8054-5553	18-0166-5915
14			27	17:21	211.5	43.57	1.669			16-6236-6224	01-9640-0272
15		Aug	21	16:01	191.8	23.94	0.9169			00-3551-6424	13-5488-9353
16		Nov	13	15:15	209.4	41.49	1.589			08-7960-8695	13-5404-7260
17		Dec	14	16:24	145.5	-22.43	-0.8592			17-3206-9966	05-5424-1058
18	2019	Jul	16	14:50	150	-17.92	-0.6863			17-3501-9465	09-5525-4882
19		Aug	13	15:30	172.2	4.342	0.1663			15-4480-3505	05-7166-6556

Chronic Larval Fish Survival and Growth Test

Pacific EcoRisk

Test Type: Growth-Survival (7d)
 Protocol: EPA/600/R-95/136 (1995)

Organism: Atherinops affinis (Topsmelt)
 Endpoint: Mean Dry Biomass-mg

Material: Copper chloride
 Source: Reference Toxicant-REF

Chronic Larval Fish Survival and Growth Test

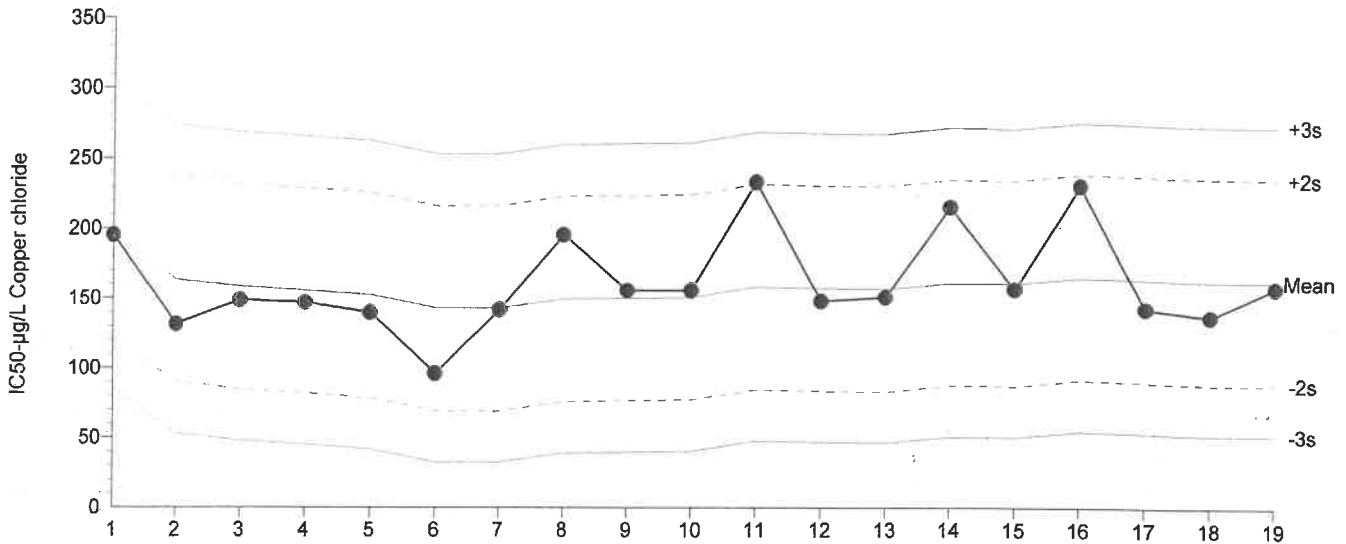

Mean: 162.1 Count: 18 -2s Warning Limit: 88.55 -3s Action Limit: 51.76
 Sigma: 36.79 CV: 22.70% +2s Warning Limit: 235.7 +3s Action Limit: 272.5

Quality Control Data

Point	Year	Month	Day	Time	QC Data	Delta	Sigma	Warning	Action	Test ID	Analysis ID
1	2016	Dec	1	14:45	195.3	33.25	0.9037			09-7939-5083	07-5754-6003
2	2017	Jan	2	12:00	131.1	-31.02	-0.8431			12-4511-7385	15-6656-2716
3			2	13:00	148.3	-13.8	-0.375			18-4696-7845	00-5654-4406
4		Mar	21	13:30	146.7	-15.44	-0.4196			14-7502-6999	08-0647-8893
5			21	14:30	139.4	-22.67	-0.6163			20-6326-4170	03-3854-1324
6		Apr	27	15:20	95.92	-66.18	-1.799			12-5173-5100	15-1911-6681
7		May	6	15:10	141.6	-20.53	-0.558			00-9957-1385	17-5803-8095
8		Jun	13	14:20	195.6	33.48	0.91			00-7889-2529	14-9330-6229
9		Jul	13	14:35	155.5	-6.63	-0.1802			17-8123-4418	15-5385-4800
10		Aug	3	15:00	155.4	-6.731	-0.183			20-6811-8584	15-9739-7007
11		Oct	12	15:15	233.1	71.01	1.93			00-4593-9500	13-4527-3547
12		Nov	9	15:30	147.9	-14.24	-0.3871			05-6312-9853	20-2765-5437
13	2018	Feb	15	15:35	150.7	-11.41	-0.3102			11-8054-5553	01-8976-9291
14			27	17:21	215.4	53.3	1.449			16-6236-6224	10-5519-5225
15		Aug	21	16:01	156.3	-5.752	-0.1564			00-3551-6424	11-2151-1794
16		Nov	13	15:15	230.8	68.72	1.868			08-7960-8695	19-6606-9199
17		Dec	14	16:24	142.7	-19.42	-0.5278			17-3206-9966	02-7400-4954
18	2019	Jul	16	14:50	136.8	-25.31	-0.6879			17-3501-9465	12-7412-6252
19		Aug	13	15:30	157.8	-4.283	-0.1164			15-4480-3505	18-1213-2008

7 Day Chronic Topsmelt (*A. affinis*) Reference Toxicant Test Data

Client: Pacific EcoRisk
 Test Material: Copper (as cupric chloride)
 Test ID#: 84593 Project #: 30677
 Test Date: 8/13/19 Randomization: 5.7.1

Organism Log#: 11721 Age: 14d
 Organism Supplier: ABS
 Control/Diluent: Filtered Seawater
 Control Water Batch: -

Treatment (µg/L Cu)	Temp (°C)	pH		D.O. (mg/L)		Salinity (ppt)		# Live Organisms					SIGN-OFF
		new	old	new	old	new	old	A	B	C	D	E	
Control	20.0	7.85		8.0		33.6		5	5	5	5	5	Date: 8/13/19
56	20.1	7.86		8.6		33.7		5	5	5	5	5	Sample ID: -
100	20.3	7.90		8.6		33.8		5	5	5	5	5	Test Solution Prep: 78
180	20.2	7.84		8.5		33.8		5	5	5	5	5	New WQ: KP
320	20.2	7.83		8.5		33.7		5	5	5	5	5	Initiation Time: 1530
560	20.3	7.81		8.4		33.6		5	5	5	5	5	Initiation Signoff: CO
1000	20.3	7.79		8.4		33.5		5	5	5	5	5	
Meter ID:	113A	PH24		RD11		EC11							
Control	19.5	7.88	7.63	8.9	5.4	33.2	33.7	5	5	5	5	5	Date: 8/14/19
56	19.6	7.78	7.77	8.0	6.2	33.8	34.3	5	5	5	5	5	Sample ID: -
100	19.8	7.77	7.79	7.8	6.5	33.9	34.2	5	4	5	5	5	Test Solution Prep: 78
180	19.8	7.77	7.77	7.9	6.3	33.8	33.9	3	2	1	0	3	New WQ: SPS
320	19.8	7.76	7.75	7.9	6.3	33.8	33.9	1	1	2	0	0	Renewal Time: 1338
560	19.7	7.84	7.75	8.8	6.3	33.2	33.8	0	0	0	0	0	Renewal Sign-off: AP
1000	19.7	7.84	7.79	8.8	6.5	33.0	34.1	0	0	0	0	0	Old WQ: TA
Meter ID:	99A	PH24	PH24	RD10	RD10	EC10	EC10						
Control	19.5	7.81	7.71	9.1	5.8	32.6	33.9	4	5	5	5	5	Date: 8/15/19
56	19.5	7.83	7.66	9.3	5.9	33.2	34.1	5	5	5	4	5	Sample ID: -
100	19.5	7.84	7.70	9.3	6.1	33.1	33.9	5	4	5	5	5	Test Solution Prep: 78
180	19.4	7.84	7.70	9.3	6.0	32.9	33.9	3	2	1	-	3	New WQ: KP
320	19.5	7.84	7.74	9.2	6.0	33.0	33.9	1	1	2	-	-	Renewal Time: 1130
560	-	-	-	-	-	-	-	-	-	-	-	-	Renewal Sign-off: KP
1000	-	-	-	-	-	-	-	-	-	-	-	-	Old WQ: KP
Meter ID:	48A	PH15	PH24	RD12	RD12	EC14	EC14						
Control	20.4	7.85	7.63	7.6	6.7	33.1	33.7	4	5	5	5	5	Date: 8/16/19
56	20.3	7.87	7.67	7.7	6.5	33.2	34.1	5	5	5	4	5	Sample ID: -
100	20.2	7.87	7.68	7.7	6.6	33.3	34.1	5	4	5	5	5	Test Solution Prep: TK
180	20.1	7.88	7.74	7.9	6.6	33.4	34.1	3	2	1	-	3	New WQ: SD
320	20.1	7.87	7.70	7.9	6.5	33.5	33.8	1	0	2	-	-	Renewal Time: 1133
560	-	-	-	-	-	-	-	-	-	-	-	-	Renewal Sign-off: AP
1000	-	-	-	-	-	-	-	-	-	-	-	-	Old WQ: SD
Meter ID:	99A	PH26	PH26	RD10	RD10	EC10	EC10						

7 Day Chronic Topsmelt (*A. affinis*) Reference Toxicant Test Data

Client: Pacific EcoRisk
 Test Material: Copper (as cupric chloride)
 Test ID#: 84593 Project #: 30677
 Test Date: 8/13/19 Randomization: S.7.1

Organism Log#: 11721 Age: 14d.
 Organism Supplier: ABS
 Control/Diluent: Filtered Seawater
 Control Water Batch: -

Treatment (% Effluent)	Temp (°C)	pH		D.O. (mg/L)		Salinity (ppt)		# Live Organisms					SIGN-OFF
		new	old	new	old	new	old	A	B	C	D	E	
Control	19.2	7.85	7.67	8.4	6.4	33.5	33.7	4	5	5	5	5	Date: 8/13/19 Sample ID: -
56	19.0	7.86	7.70	8.5	6.5	33.9	33.5	5	5	5	4	5	Test Solution Prep: <u>APF</u> New WQ: <u>APF</u>
100	19.1	7.86	7.73	8.5	6.4	33.9	34.2	4	4	5	5	5	Renewal Time: <u>1103</u>
180	19.1	7.86	7.78	8.5	6.6	34.0	34.3	3	2	1	-	3	Renewal-Sign-off: <u>SMC</u>
320	19.0	7.85	7.75	8.6	6.6	33.9	34.3	1	-	2	-	-	Old WQ: <u>SAT</u>
560	-	-	-	-	-	-	-	-	-	-	-	-	
1000	-	-	-	-	-	-	-	-	-	-	-	-	
Meter ID:	97A	PH26	PH25	RD10	RD13	EC10	EC14						
Control	20.5	7.77	7.58	8.4	6.5	34.0	34.4	4	5	5	5	5	Date: 8/14/19 Sample ID: -
56	20.5	7.75	7.62	8.3	6.4	34.3	34.5	5	4	5	4	4	Test Solution Prep: <u>TK</u>
100	20.5	7.75	7.67	8.3	6.4	34.2	34.4	4	4	5	5	5	New WQ: <u>AP</u>
180	20.4	7.75	7.69	8.3	6.5	34.3	34.6	2	2	1	-	3	Renewal Time: <u>1345</u>
320	20.5	7.74	7.69	8.3	6.4	34.2	34.5	1	-	2	-	-	Renewal-Sign-off: <u>KL</u>
560	-	-	-	-	-	-	-	-	-	-	-	-	Old WQ: <u>3V</u>
1000	-	-	-	-	-	-	-	-	-	-	-	-	
Meter ID:	59A	PH26	PH26	RD13	RD13	EC11	EC11						
Control	19.7	7.82	7.67	8.7	6.5	33.4	34.0	4	5	5	4	5	Date: 8/19/19 Sample ID: -
56	19.7	7.87	7.69	9.2	6.5	33.4	34.1	5	4	5	4	4	Test Solution Prep: <u>TK</u>
100	19.7	7.87	7.70	9.2	6.4	33.4	34.0	4	4	5	5	5	New WQ: <u>TP</u>
180	19.7	7.87	7.73	9.1	6.5	33.4	34.1	2	2	1	-	3	Renewal Time: <u>1310</u>
320	19.7	7.86	7.70	9.3	6.4	33.4	34.2	1	-	1	-	-	Renewal-Sign-off: <u>KL</u>
560	-	-	-	-	-	-	-	-	-	-	-	-	Old WQ: <u>TP</u>
1000	-	-	-	-	-	-	-	-	-	-	-	-	
Meter ID:	57A	PH24	PH24	RD13	RD13	EC13	EC13						
Control	20.5		7.71		6.6		33.9	4	5	5	4	5	Date: 8/20/19 Termination Time: <u>0835</u>
56	20.3		7.72		6.6		34.1	5	4	5	4	4	Termination Sign-off: <u>SMC</u>
100	20.5		7.76		6.6		34.0	4	4	5	5	5	Old WQ: <u>JR</u>
180	20.5		7.81		6.7		34.1	2	2	1	-	3	
320	20.4		7.82		6.8		34.0	1	-	1	-	-	
560	-		-		-		-	-	-	-	-	-	
1000	-		-		-		-	-	-	-	-	-	
Meter ID:	112A		PH25		RD13		EC13						

APF 8/17/19
APF 8/17/19

Topsmelt (*A. affinis*) Dry Weight Data Sheet

Client: Reference Toxicant Test ID #: 84593 Project # 30677
 Test Material: Copper (as cupric chloride) Tare Weight Date: 8/15/19 Sign-off: SJB
 Test Date: 8/13/19 Final Weight Date: 8/21/19 Sign-off: D4

Pan ID	Concentration	Replicate	Initial Pan Weight (mg)	Final Pan Weight (mg)	Initial # of Organisms	Biomass Value (mg)
1	Control	A	405.04	410.00	5	0.992
2		B	410.71	419.74	5	1.81
3		C	415.76	426.51	5	2.15
4		D	407.44	^{PH} 410 413.64	5	1.24
5		E	410.33	416.98	5	1.33
6	56	A	410.99	416.47	5	1.11
7		B	414.88	422.67	5	1.56
8		C	412.73	420.54	5	1.56
9		D	404.43	411.87	5	1.49
10		E	406.37	413.99	5	1.52
11	100	A	413.61	420.20	5	1.32
12		B	409.70	417.19	5	1.50
13		C	409.36	416.64	5	1.46
14		D	407.42	416.05	5	1.73
15		E	414.72	422.54	5	1.56
16	180	A	408.15	410.56	5	0.482
17		B	404.50	405.60	5	0.220
18		C	413.06	415.62	5	0.512
19		D	415.48	—	5	0.0
20		E	414.72	420.46	5	1.15
21	320	A	415.33	416.14	5	0.162
22		B	428.53	—	5	0.0
23		C	407.77	408.65	5	0.176
24		D	410.86	—	5	0.0
25		E	412.96	—	5	0.0
26	560	A	413.28	—	5	0.0
27		B	409.42	—	5	0.0
28		C	414.04	—	5	0.0
29		D	405.99	—	5	0.0
30		E	416.66	—	5	0.0
31	1000	A	414.65	—	5	0.0
32		B	404.78	—	5	0.0
33		C	412.08	—	5	0.0
34		D	428.92	—	5	0.0
35		E	421.62	—	5	0.0
QA1			402.54	402.55		
QA2			409.85	409.83		
QA3			409.90	409.91		
Balance ID:			Ba104	Ba104		



Regina Thill
Crescent City Water Quality Control Laboratory
377 J Street
Crescent City, CA 95531

September 9, 2020

Regina:

I have enclosed our report “Chronic Toxicity Testing of Crescent City Wastewater Treatment Plant Effluent” for the effluent samples collected August 17, 19, and 21, 2020. The results of this test are summarized below.

Chronic Toxicity of Crescent City Effluent to *Atherinops affinis*

There was a 0% effect in survival and a 1.5% effect in growth; the TST analysis resulted in a pass for both endpoints.

If you have any questions regarding this testing, please feel free to call me at (707) 207-7760.

Regards,

Stevi Vasquez
Project Manager



Pacific EcoRisk is accredited in accordance with NELAP (ORELAP ID 4043). Pacific EcoRisk certifies that the test results reported herein conform to the most current NELAP requirements for parameters for which accreditation is required and available. Any exceptions to NELAP requirements are noted, where applicable, in the body of the report. This report shall not be reproduced, except in full, without the written consent of Pacific EcoRisk. This testing was performed under Lab Order 31918.

Chronic Toxicity Testing of Crescent City Wastewater Treatment Plant Effluent

Samples collected August 17, 19, and 21, 2020

Performed For

City of Crescent City
Water Quality Control Laboratory
377 J Street
Crescent City, CA 95531

Prepared By

Pacific EcoRisk, Inc.
2250 Cordelia Road
Fairfield, CA 94534

September 2020



Chronic Toxicity Testing of Crescent City Wastewater Treatment Plant Effluent

Samples collected August 17, 19, and 21, 2020

Table of Contents

	Page
1. INTRODUCTION	1
2. TOXICITY TEST PROCEDURES	1
2.1 Sample Receipt and Handling	1
2.2 Chronic Toxicity Testing with <i>Atherinops affinis</i>	1
2.3 Reference Toxicant Testing of the <i>Atherinops affinis</i>	2
3. RESULTS	3
3.1 Chronic Toxicity of Crescent City Effluent to <i>Atherinops affinis</i>	3
3.2 Reference Toxicant Toxicity to <i>Atherinops affinis</i>	3
4. SUMMARY AND CONCLUSIONS	4
4.1 QA/QC Summary	4

Appendices

Appendix A Chain-of-Custody Records for the Collection and Delivery of the Samples

Appendix B Test Data and Summary of Statistics for the Evaluation of the Chronic Toxicity of Crescent City Effluent to *Atherinops affinis*

Appendix C Test Data and Summary of Statistics for the Reference Toxicant Evaluation of the *Atherinops affinis*



1. INTRODUCTION

The City of Crescent City has contracted Pacific EcoRisk (PER) to perform an evaluation of the chronic toxicity of Crescent City Wastewater Treatment Plant (Crescent City) effluent. This evaluation consisted of performing the EPA chronic toxicity test with topsmelt (*Atherinops affinis*) using effluent samples that were collected on August 17, 19, and 21, 2020. In order to assess the sensitivity of the test organisms to toxic stress, a reference toxicant test was also performed. This report describes the performance and results of these tests.

2. TOXICITY TEST PROCEDURES

The methods used in this testing followed the guidelines established by the EPA manual “Short-Term Methods for Estimating the Chronic Toxicity of Effluents and Receiving Waters to West Coast Marine and Estuarine Organisms” (EPA/600/R-95/136).

2.1 Sample Receipt and Handling

On August 17, 19, and 21, samples of Crescent City effluent were collected into appropriately cleaned sample containers and transported on ice and under chain-of-custody to the PER laboratory in Fairfield, CA. Upon receipt at the laboratory, aliquots of each sample were collected for analysis of initial water quality characteristics (Table 1), with the remainder of the samples being stored at $\leq 6^{\circ}\text{C}$, except when being used to prepare test solutions. The chain-of-custody records for the collection and delivery of the samples are presented in Appendix A.

Date Sample Received	Sample ID	Temp (°C)	pH	D.O (mg/L)	Salinity (ppt)	Conductivity (µS/cm)	Total Ammonia (mg/L N)
8/18/20	EFF-001	0.5	7.17	10.1	0.3	552	3.2
8/20/20	EFF-001	2.1	7.13	8.6	0.4	678	3.0
8/22/20	EFF-001	3.6	7.28	6.6	0.3	671	6.2

2.2 Chronic Toxicity Testing with *Atherinops affinis*

The chronic toxicity test with *Atherinops affinis* consists of exposing larval fish to the effluent for 7 days, after which effects on survival and growth are evaluated. The specific procedures used in this testing are described below.

The larval fish used in these tests were obtained from a commercial supplier (Aquatic Biosystems, Fort Collins, CO). Upon receipt at the testing lab, the larval fish were maintained in a tank containing Lab Water Control medium. The fish were fed brine shrimp nauplii *ad libitum* during the pre-test holding period.



The Lab Water Control medium for these tests consisted of 1 µm filtered seawater (U.C. Granite Canyon Marine Laboratory, CA). The Lab Water Control medium and effluent were used to prepare test solutions at a single test treatment concentration of 3.45% effluent. Routine water quality characteristics (pH, D.O., and salinity) were measured for each test solution prior to use in these tests.

There were five replicates for each test treatment, each replicate consisting of 200 mL of test solution in a 600-mL glass beaker. The tests were initiated by randomly allocating five 14-day old topsmelt into each replicate beaker. The beakers were randomly positioned in a temperature-controlled room at 20°C, under a 16L:8D photoperiod. These test fish were fed brine shrimp nauplii twice daily.

Each day of the tests, fresh test solutions were prepared as before. The test replicate beakers were examined, with any dead animals, uneaten food, wastes, and other detritus being removed. The number of live fish in each replicate was determined and then approximately 80% of the test media in each beaker was carefully poured out and replaced with fresh media. “Old” water quality characteristics (pH and D.O.) were measured on the old test water collected from one randomly selected replicate at each treatment.

After 7 days exposure, the tests were terminated and the number of live fish in each replicate beaker was recorded. The fish from each replicate were then carefully euthanized in methanol, rinsed in de-ionized water, and transferred to a pre-dried and pre-tared weighing pan. The fish were then dried at 100°C for ≥24 hours and re-weighed to determine the total weight of fish in each replicate. The total weight was then divided by the initial number of fish per replicate to determine the biomass value. The resulting survival and biomass value data were analyzed to determine any impairment(s) caused by the effluent. All statistical analyses were performed using CETIS® (Tidepool Scientific Software, McKinleyville, CA).

2.3 Reference Toxicant Testing of the *Atherinops affinis*

The reference toxicant test was performed similarly to the effluent test, but used test solutions consisting of Lab Water Control medium spiked with copper chloride at concentrations of 56, 100, 180, 320, 560, and 1000 µg Cu/L. The resulting test response data were analyzed to determine key dose-response point estimates. All statistical analyses were made using CETIS. These response endpoints were then compared to the typical response ranges established by the mean ± 2 SD of the point estimates generated by the most recent previous reference toxicant tests performed by this lab.



3. RESULTS

3.1 Chronic Toxicity of Crescent City Effluent to *Atherinops affinis*

The results of this test are summarized in Table 2. There was a 0% effect in survival and a 1.5% effect in growth; the TST analysis resulted in a pass for both endpoints. The test data and summary of statistics for this test are presented in Appendix B.

Effluent Treatment	Mean % Survival	TST Analysis (Survival)	% Effect (Survival)	Mean Biomass Value (mg)	TST Analysis (Biomass)	% Effect (Biomass)
Lab Water Control	100			1.86		
3.45%	100	Pass	0%	1.83	Pass	1.5%

3.2 Reference Toxicant Toxicity to *Atherinops affinis*

The results of this test are summarized in Table 3. The EC₅₀ and IC₅₀ for this test were consistent with the typical response ranges established by the reference toxicant test database for this species, indicating that the organisms were responding to toxic stress in a typical fashion. The test data and summary of statistics for this test are presented in Appendix C.

Cu Concentration (µg/L)	Mean % Survival	Mean Biomass Value (mg)
Lab Water Control	95.0	1.58
56	100	1.73
100	96.0	1.71
180	84.0	1.35
320	16.0*	0.18
560	0*	-
1000	0*	-
Summary of Statistics		
Survival EC ₅₀ or Growth IC ₅₀ =	240 µg/L CuCl ₂	242 µg/L CuCl ₂

* The response at this test treatment was significantly less than the Lab Water Control treatment response ($p < 0.05$).



4. SUMMARY AND CONCLUSIONS

An evaluation of the chronic toxicity of Crescent City effluent was performed using effluent samples collected August 17, 19, and 21, 2020. The results of this test are summarized below.

Chronic Toxicity of Crescent City Effluent to *Atherinops affinis*

There was a 0% effect in survival and a 1.5% effect in growth; the TST analysis resulted in a pass for both endpoints.

4.1 QA/QC Summary

Test Conditions – Test conditions (pH, D.O., temperature, etc.) were within acceptable limits. All analyses were performed according to laboratory Standard Operating Procedures.

Negative Control – The biological responses of the Lab Control treatments were within acceptable limits.

Positive Control – The results of the reference toxicant test were consistent with the typical response ranges established by the reference toxicant test database for this species, indicating that the test organisms were responding to toxicant stress in a typical and consistent fashion.

Concentration Response Relationships – The concentration-response relationship for the reference toxicant test was evaluated per EPA guidelines (EPA-821-B-00-004) and was determined to be acceptable.



Appendix A

Chain-of-Custody Records for the Collection and Delivery of the Samples





Pacific EcoRisk
 2250 Cordelia Rd., Fairfield, CA 94534
 (707) 207-7760 FAX (707) 207-7916

CHAIN-OF-CUSTODY RECORD

Results To: Crescent City Water Quality Control Lab		Invoice To: Same		REQUESTED ANALYSIS																
Address: 377 J Street Crescent City, CA 95531		Address:																		
Phone: (707) 465-5258		Phone:		Atherinops affinis Survival and Growth, EPA-600-R-95-136																
Attn: Regina Goodgame-Thill		Attn:																		
E-mail: rthill@crescentcity.org; David.Zevely@jacobs.com		E-mail:																		
Project Name: Annual Toxicity Testing																				
P.O.#/Ref: 53379																				
Client Sample ID	Sample Date	Sample Time	Sample Matrix*	Grab/Comp	Container		X													
					Number	Type														
1 EFF-001	8/17/20	1305	EFF	Grab	1	1-gal cubitainer	X													
2																				
3																				
4																				
5																				
6																				
7																				
8																				
9																				
10																				
Samples collected by:																				
Comments/Special Instruction: Cl= 0.06 PO= 53379							RELINQUISHED BY: David Zevely							RECEIVED BY:						
							Signature: <i>[Signature]</i>							Signature: <i>[Signature]</i>						
							Print: D. ZEVELY							Print: Regina Goodgame Thill						
							Organization: JACOBS							Organization: CWQL						
							Date: 8/17/20 Time: 1316							Date: 8/17/20 Time: 1316						
							RELINQUISHED BY:							RECEIVED BY: Hannah Duane						
Signature: <i>[Signature]</i>							Signature: <i>[Signature]</i>													
Print: Regina Goodgame Thill							Print: Hannah Duane													
Organization: CWQL							Organization: PER													
Date: 8/17/20 Time: 1521							Date: 8/18/20 Time: 1051													

*Example Matrix Codes: (EFF - Effluent) (FW = Freshwater); (SW = Saltwater); (WW = Wastewater); (STRMW = Stormwater); (SED = Sediment); or other



Pacific EcoRisk
 2250 Cordelia Rd., Fairfield, CA 94534
 (707) 207-7760 FAX (707) 207-7916

CHAIN-OF-CUSTODY RECORD

Results To: Crescent City Water Quality Control Lab		Invoice To: Same		REQUESTED ANALYSIS																		
Address: 377 J Street Crescent City, CA 95531		Address:		Atherinops affinis Survival and Growth, EPA-600-R-95-136																		
Phone: (707) 465-5258		Phone:																				
Attn: Regina Goodgame-Thill		Attn:																				
E-mail: rthill@crescentcity.org; David.Zevely@jacobs.com		E-mail:																				
Project Name: Annual Toxicity Testing																						
P.O.#/Ref: 53379																						
Client Sample ID	Sample Date	Sample Time	Sample Matrix*	Grab/Comp	Container		X															
					Number	Type																
1 EFF-001	8/19/20	1312	EFF	Grab	1	1-gal cubitainer																
2																						
3																						
4																						
5																						
6																						
7																						
8																						
9																						
10																						
Samples collected by: DAVID ZEVELY																						
Comments/Special Instruction: C1=000				RELINQUISHED BY: [Signature]				RECEIVED BY:														
				Signature: [Signature]				Signature: [Signature]														
				Print: DAVID ZEVELY				Print: Regina Goodgame-Thill														
				Organization: JACOBS				Organization: CWC														
				Date: 8/19/20 Time: 1319				Date: 8/19/20 Time: 1319														
				RELINQUISHED BY:				RECEIVED BY:														
Signature: [Signature]				Signature: Brooke Thomas																		
Print: Regina Goodgame-Thill				Print: BROOKE THOMAS																		
Organization: CWC				Organization: PER																		
Date: 8/19/20 Time: 1330				Date: 9/20/20 Time: 1130																		

*Example Matrix Codes: (EFF - Effluent) (FW = Freshwater); (SW = Saltwater); (WW = Wastewater); (STRMW = Stormwater); (SED = Sediment); or other



Pacific EcoRisk
 2250 Cordelia Rd., Fairfield, CA 94534
 (707) 207-7760 FAX (707) 207-7916

CHAIN-OF-CUSTODY RECORD

Results To:	Crescent City Water Quality Control Lab	Invoice To:	Same	REQUESTED ANALYSIS Atherinops affinis Survival and Growth, EPA-600-R-95-136									
Address:	377 J Street Crescent City, CA 95531	Address:											
Phone:	(707) 465-5258	Phone:											
Attn:	Regina Goodgame-Thill	Attn:											
E-mail:	rthill@crescentcity.org; David.Zevely@jacobs.com	E-mail:											
Project Name:	Annual Toxicity Testing												
P.O.#/Ref:	53379												

	Client Sample ID	Sample Date	Sample Time	Sample Matrix*	Grab/Comp	Container													
						Number	Type												
1	EFF-001	8/21/20	1310	EFF	Grab	1	1-gal cubitainer	X											
2																			
3																			
4																			
5																			
6																			
7																			
8																			
9																			
10																			

Samples collected by:	DAVID ZEVELY	
Comments/Special Instruction: C1 = 0.00	RELINQUISHED BY:	RECEIVED BY:
	Signature: <i>[Signature]</i>	Signature: <i>[Signature]</i>
	Print: DAVID ZEVELY	Print: Regina Goodgame-Thill
	Organization: JACOBS	Organization: CCRWQ
	Date: 8/21/20 Time: 1318	Date: 8/21/20 Time: 1315
	RELINQUISHED BY:	RECEIVED BY:
	Signature: <i>[Signature]</i>	Signature: <i>[Signature]</i>
	Print: Regina Goodgame-Thill	Print: Miranda Brun
	Organization: CCRWQ	Organization: PER
	Date: 8/21/20 Time: 1318	Date: 8/22/20 Time: 1000

*Example Matrix Codes: (EFF - Effluent) (FW = Freshwater); (SW = Saltwater); (WW = Wastewater); (STRMW = Stormwater); (SED = Sediment); or other

Appendix B

Test Data and Summary of Statistics for the Evaluation of the Chronic Toxicity of Crescent City Effluent to *Atherinops affinis*



CETIS Summary Report

Report Date: 31 Aug-20 11:34 (p 1 of 1)
Test Code/ID: 89098 / 10-7684-5337

Chronic Larval Fish Survival and Growth Test

Pacific EcoRisk

Batch ID: 07-0283-6698	Test Type: Growth-Survival (7d)	Analyst: Stevi Vasquez
Start Date: 18 Aug-20 15:52	Protocol: EPA/600/R-95/136 (1995)	Diluent: Filtered Seawater
Ending Date: 25 Aug-20 08:16	Species: Atherinops affinis	Brine: Not Applicable
Test Length: 6d 16h	Taxon: Actinopterygii	Source: Aquatic Biosystems, CO Age: 14

Sample ID: 05-9782-9897	Code: Effluent	Project: 31918
Sample Date: 17 Aug-20 13:05	Material: Effluent	Source: City of Crescent City
Receipt Date: 18 Aug-20 10:51	CAS (PC):	Station: EFF-001
Sample Age: 27h (0.5 °C)	Client: Crescent City	

Single Comparison Summary

Analysis ID	Endpoint	Comparison Method	P-Value	Comparison Result	S
20-7033-9270	7d Survival Rate	TST-Welch's t Test	<0.25	3.45% passed 7d survival rate	1
19-8527-9672	Mean Dry Biomass-mg	TST-Welch's t Test	0.0031	3.45% passed mean dry biomass-mg	1

7d Survival Rate Summary

Conc-%	Code	Count	Mean	95% LCL	95% UCL	Min	Max	Std Err	Std Dev	CV%	%Effect
0	LW	5	1.000	1.000	1.000	1.000	1.000	0.000	0.000	---	0.00%
3.45		5	1.000	1.000	1.000	1.000	1.000	0.000	0.000	---	0.00%

Mean Dry Biomass-mg Summary

Conc-%	Code	Count	Mean	95% LCL	95% UCL	Min	Max	Std Err	Std Dev	CV%	%Effect
0	LW	5	1.86	1.74	1.98	1.75	2.01	0.0436	0.0975	5.24%	0.00%
3.45		5	1.83	1.58	2.08	1.62	2.08	0.0904	0.202	11.02%	1.50%

7d Survival Rate Detail

MD5: E0625924E27BDD5BA5CD2DDC1F8E44F1

Conc-%	Code	Rep 1	Rep 2	Rep 3	Rep 4	Rep 5
0	LW	1.000	1.000	1.000	1.000	1.000
3.45		1.000	1.000	1.000	1.000	1.000

Mean Dry Biomass-mg Detail

MD5: 3FFB5A1B9AD9228385E154E168FD8D78

Conc-%	Code	Rep 1	Rep 2	Rep 3	Rep 4	Rep 5
0	LW	1.75	2.01	1.9	1.84	1.81
3.45		1.62	2.01	2.08	1.78	1.68

7d Survival Rate Binomials

Conc-%	Code	Rep 1	Rep 2	Rep 3	Rep 4	Rep 5
0	LW	5/5	5/5	5/5	5/5	5/5
3.45		5/5	5/5	5/5	5/5	5/5

CETIS Analytical Report

Report Date: 31 Aug-20 11:34 (p 1 of 2)
 Test Code/ID: 89098 / 10-7684-5337

Chronic Larval Fish Survival and Growth Test **Pacific EcoRisk**

Analysis ID: 20-7033-9270	Endpoint: 7d Survival Rate	CETIS Version: CETISv1.9.7
Analyzed: 31 Aug-20 11:34	Analysis: Parametric Bioequivalence-Two Sample	Status Level: 1
Edit Date: 31 Aug-20 11:33	MD5 Hash: E0625924E27BDD5BA5CD2DDC1F8E44F	Editor ID: 001-771-848-3

Data Transform	Alt Hyp	TST_b	Comparison Result
Angular (Corrected)	C*b < T	0.75	3.45% passed 7d survival rate endpoint

TST-Welch's t Test							
Control	vs	Conc-%	Test Stat	Critical	P-Type	P-Value	Decision(α:25%)
Lab Water Contr		3.45*	0.336	---		<0.25	Non-Significant Effect

ANOVA Table						
Source	Sum Squares	Mean Square	DF	F Stat	P-Value	Decision(α:5%)
Between	0	0	1			Indeterminate
Error	0	0	8			
Total	0		9			

ANOVA Assumptions Tests						
Attribute	Test	Test Stat	Critical	P-Value	Decision(α:1%)	
Variance	Variance Ratio F Test				Indeterminate	
Distribution	Shapiro-Wilk W Normality Test				Indeterminate	

7d Survival Rate Summary											
Conc-%	Code	Count	Mean	95% LCL	95% UCL	Median	Min	Max	Std Err	CV%	%Effect
0	LW	5	1.000	1.000	1.000	1.000	1.000	1.000	0.000	0.00%	0.00%
3.45		5	1.000	1.000	1.000	1.000	1.000	1.000	0.000	0.00%	0.00%

Angular (Corrected) Transformed Summary											
Conc-%	Code	Count	Mean	95% LCL	95% UCL	Median	Min	Max	Std Err	CV%	%Effect
0	LW	5	1.350	1.350	1.350	1.350	1.350	1.350	0.000	0.00%	0.00%
3.45		5	1.350	1.350	1.350	1.350	1.350	1.350	0.000	0.00%	0.00%

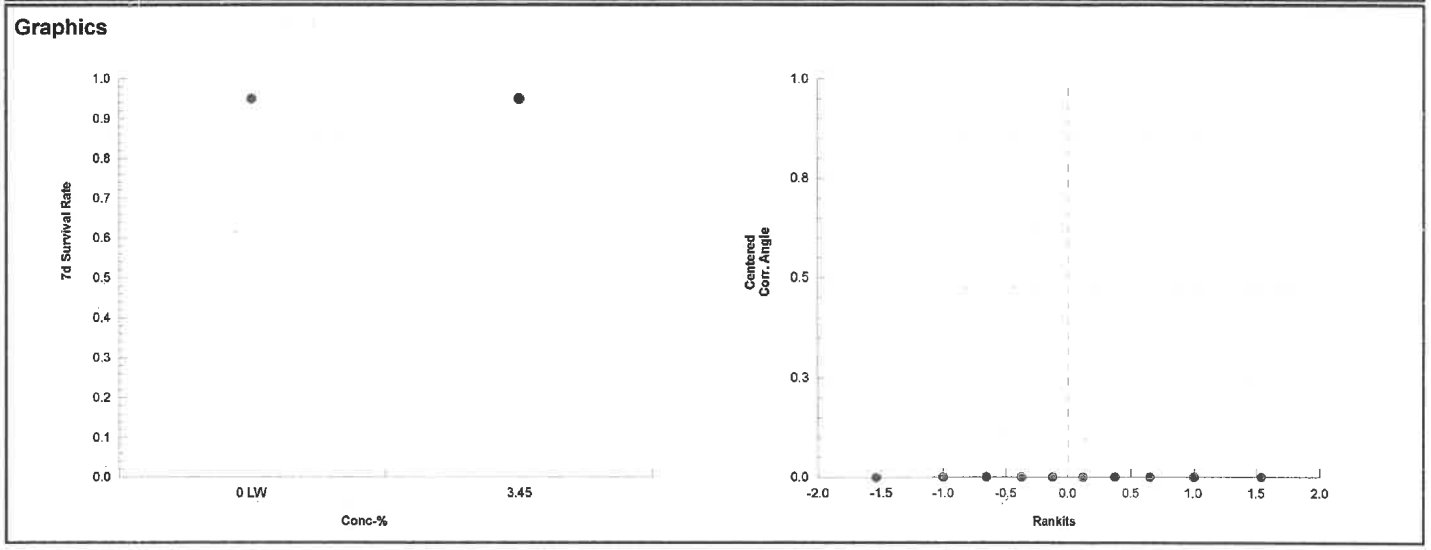

CETIS Analytical Report

Report Date: 31 Aug-20 11:34 (p 2 of 2)
 Test Code/ID: 89098 / 10-7684-5337

Chronic Larval Fish Survival and Growth Test **Pacific EcoRisk**

Analysis ID: 19-8527-9572	Endpoint: Mean Dry Biomass-mg	CETIS Version: CETISv1.9.7
Analyzed: 31 Aug-20 11:34	Analysis: Parametric Bioequivalence-Two Sample	Status Level: 1
Edit Date: 31 Aug-20 11:33	MD5 Hash: 3FFB5A1B9AD9228385E154E168FD8D78	Editor ID: 001-771-848-3

Data Transform	Alt Hyp	TST_b	Comparison Result
Untransformed	C*b < T	0.75	3.45% passed mean dry biomass-mg endpoint

TST-Welch's t Test

Control	vs	Conc-%	Test Stat	Critical	DF	P-Type	P-Value	Decision(α:25%)
Lab Water Contr		3.45*	4.55	0.727	5	CDF	0.0031	Non-Significant Effect

ANOVA Table

Source	Sum Squares	Mean Square	DF	F Stat	P-Value	Decision(α:5%)
Between	0.0019599	0.0019599	1	0.0779	0.7873	Non-Significant Effect
Error	0.201328	0.0251661	8			
Total	0.203288		9			

ANOVA Assumptions Tests

Attribute	Test	Test Stat	Critical	P-Value	Decision(α:1%)
Variance	Variance Ratio F Test	4.29	23.2	0.1872	Equal Variances
Distribution	Shapiro-Wilk W Normality Test	0.957	0.741	0.7552	Normal Distribution

Mean Dry Biomass-mg Summary

Conc-%	Code	Count	Mean	95% LCL	95% UCL	Median	Min	Max	Std Err	CV%	%Effect
0	LW	5	1.86	1.74	1.98	1.84	1.75	2.01	0.0436	5.24%	0.00%
3.45		5	1.83	1.58	2.08	1.78	1.62	2.08	0.0904	11.02%	1.50%

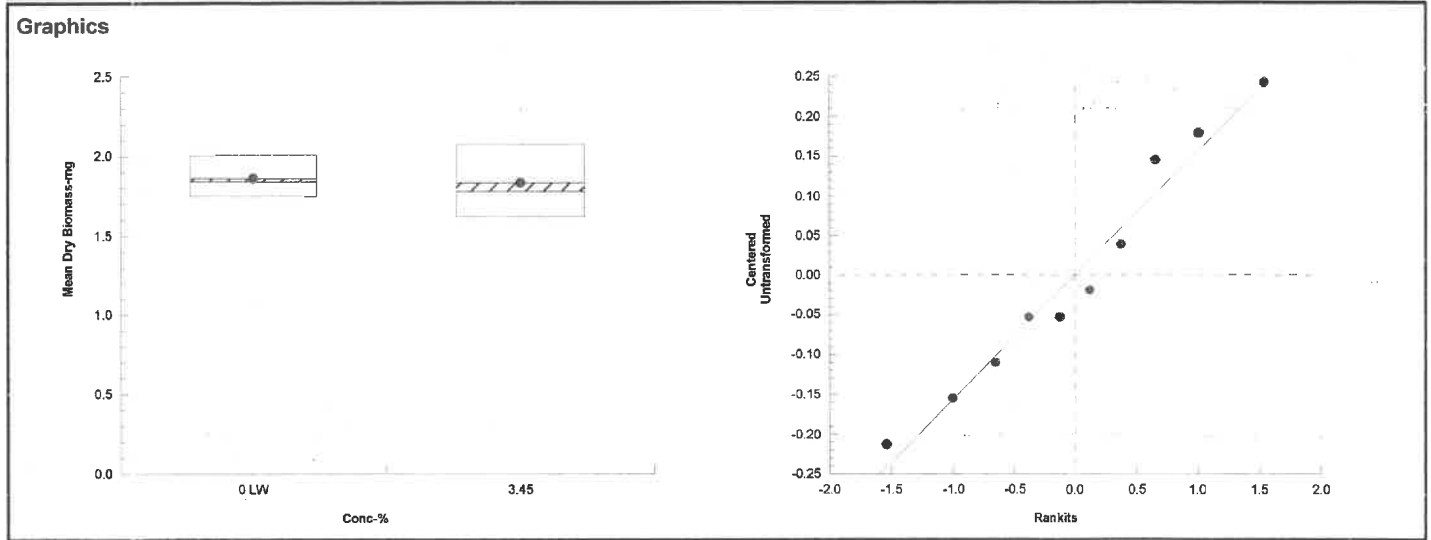

7 Day Chronic Topsmelt (*A. affinis*) Toxicity Test Data

Client: Crescent City Organism Log#: 12256 Age: 14 days
 Test Material: Effluent Organism Supplier: ABS
 Test ID#: 89098 Project #: 31918 Control Water: Filtered Seawater
 Test Date: 8/18/20 Randomization: 5.4.1

Test Treatment	Temp (°C)	pH		D.O. (mg/L)		Salinity (ppt)	# Live Organisms					SIGN-OFF
		new	old	new	old		A	B	C	D	E	
Lab Control	20.1	7.80		7.9		34.3	5	5	5	5	5	Date: 8/18/20 Sample ID: 56755
3.45%	20.0	7.90		6.7		33.3	5	5	5	5	5	Test Solution Prep: TK Initiation Time: 1352
Meter ID	111A	PH25		RDH		EC12	New WQ: CC					Initiation Signoff: AP
Lab Control	20.4	7.74	7.52	8.2	5.9	34.1	5	5	5	5	5	Date: 8/19/20 Sample ID: 56755
3.45%	20.2	7.77	7.52	8.4	4.5	33.4	5	5	5	5	5	Test Solution Prep: CD Renewal Time: 1310
Meter ID	114A	PH25	PH26	RD12	RD14	EC13	New WQ: HD	Old WQ: DKB				Renewal Signoff: MM
Lab Control	19.9	7.79	7.48	7.9	6.2	34.3	5	5	5	5	5	Date: 8/20/20 Sample ID: 56796
3.45%	19.9	7.79	7.51	8.0	6.3	33.7	5	5	5	5	5	Test Solution Prep: AI Renewal Time: 1349
Meter ID	115A	PH25	PH26	RD10	RD12	EC11	New WQ: HD	Old WQ: HD				Renewal Signoff: MM
Lab Control	20.9	7.72	7.63	8.4	6.6	34.7	5	5	5	5	5	Date: 8/21/20 Sample ID: 56796
3.45%	20.8	7.73	7.59	8.3	6.1	33.4	5	5	5	5	5	Test Solution Prep: SL Renewal Time: 1645
Meter ID	80A	PH25	PH25	RD10	RD10	EC13	New WQ: MB	Old WQ: MB				Renewal Signoff: TK
Lab Control	20.2	7.78	7.67	7.4	6.6	34.3	5	5	5	5	5	Date: 8/22/20 Sample ID: 56818
3.45%	20.2	7.77	7.63	7.3	6.3	33.3	5	5	5	5	5	Test Solution Prep: TF Renewal Time: 1349
Meter ID	111A	PH25	PH24	RD10	RD14	EC14	New WQ: MB	Old WQ: CD				Renewal Signoff: TF
Lab Control	20.8	7.94	7.60	7.3	8.3	34.5	5	5	5	5	5	Date: 8/23/20 Sample ID: 56818
3.45%	20.8	7.94	7.69	7.3	8.0	33.4	5	5	5	5	5	Test Solution Prep: TK Renewal Time: 1120
Meter ID	116A	PH25	PH26	RD12	RD12	EC12	New WQ: DD	Old WQ: BS				Renewal Signoff: TK
Lab Control	20.3	7.96	7.63	6.9	4.7	34.3	5	5	5	5	5	Date: 8/24/20 Sample ID: 56818
3.45%	20.5	7.95	7.61	6.9	5.4	33.3	5	5	5	5	5	Test Solution Prep: TK Renewal Time: 1100
Meter ID	59A	PH25	PH24	RD12	RD14	EC11	New WQ: HD	Old WQ: HD				Renewal Signoff: KL
Lab Control	20.5		7.51		5.5	35.2	5	5	5	5	5	Date: 8/25/20 Termination Time: 0816
3.45%	20.3		7.59		5.6	34.3	5	5	5	5	5	Termination Signoff: TF
Meter ID	114A		PH24		RD12	EC12						Old WQ: AS

Chronic Topsmelt Dry Weight and Biomass Data

Client: Crescent City Test ID #: 89098 Project # 31918
 Sample: Effluent Tare Weight Date: 8/23/20 Sign-off: DKB
 Test Date: 8/18/20 Final Weight Date: 9/20/20 Sign-off: BT

Pan ID	Concentration	Replicate	Initial Pan Weight (mg)	Final Pan Weight (mg)	Initial # of Organisms	
1	Control	A	410.65	419.40	5	
2		B	408.29	419.32	5	
3		C	411.26	420.76	5	
4		D	412.09	421.30	5	
5		E	417.09	426.13	5	
6	3.45%	A	406.62	414.72	5	
7		B	401.06	411.12	5	
8		C	410.43	420.81	5	
9		D	407.75	416.65	5	
10		E	409.05	417.44	5	
QA 1			409.79	409.80		
Balance ID			BAL04	BAL04		

Appendix C

Test Data and Summary of Statistics for the Reference Toxicant Evaluation of the *Atherinops affinis*



CETIS Summary Report

Report Date: 08 Sep-20 09:09 (p 1 of 2)
 Test Code/ID: 89626 / 11-3958-2180

Chronic Larval Fish Survival and Growth Test

Pacific EcoRisk

Batch ID: 04-6864-5289	Test Type: Growth-Survival (7d)	Analyst: Stevi Vasquez
Start Date: 25 Aug-20 13:20	Protocol: EPA/600/R-95/136 (1995)	Diluent: Filtered Seawater
Ending Date: 01 Sep-20 08:45	Species: Atherinops affinis	Brine: Not Applicable
Test Length: 6d 19h	Taxon: Actinopterygii	Source: Aquatic Biosystems, CO Age: 14
Sample ID: 04-5322-7918	Code: CuCl2	Project: 32041
Sample Date: 25 Aug-20 13:20	Material: Copper chloride	Source: Reference Toxicant
Receipt Date: 25 Aug-20 13:20	CAS (PC):	Station: In House
Sample Age: --- (20.7 °C)	Client: Pacific EcoRisk	

Multiple Comparison Summary							
Analysis ID	Endpoint	Comparison Method	✓ NOEL	LOEL	TOEL	PMSD	S
17-7473-6708	7d Survival Rate	Steel Many-One Rank Sum Test	180	320	240	18.5%	1
05-1744-4960	Mean Dry Biomass-mg	Dunnett Multiple Comparison Test	180	>180	---	24.7%	1

Point Estimate Summary							
Analysis ID	Endpoint	Point Estimate Method	✓ Level	µg/L	95% LCL	95% UCL	S
08-1159-7549	7d Survival Rate	Spearman-Kärber	✓ EC50	240	212	271	1
09-7913-6021	Mean Dry Biomass-mg	Linear Interpolation (ICPIN)	✓ IC10	142	83.7	219	1
			✓ IC15	163	109	220	
			✓ IC20	182	121	223	
			✓ IC25	192	132	229	
			✓ IC40	222	168	250	
			IC50	242	198	267	

7d Survival Rate Summary											
Conc-µg/L	Code	Count	Mean	95% LCL	95% UCL	Min	Max	Std Err	Std Dev	CV%	%Effect
0	LW	5	0.950	0.811	1.090	0.750	1.000	0.050	0.112	11.77%	0.00%
56		5	1.000	1.000	1.000	1.000	1.000	0.000	0.000	---	-5.26%
100		5	0.960	0.849	1.070	0.800	1.000	0.040	0.089	9.32%	-1.05%
180		5	0.840	0.632	1.050	0.600	1.000	0.075	0.167	19.92%	11.58%
320		5	0.160	-0.048	0.368	0.000	0.400	0.075	0.167	104.58%	83.16%
560		5	0.000	0.000	0.000	0.000	0.000	0.000	0.000	---	100.00%
1000		5	0.000	0.000	0.000	0.000	0.000	0.000	0.000	---	100.00%

Mean Dry Biomass-mg Summary											
Conc-µg/L	Code	Count	Mean	95% LCL	95% UCL	Min	Max	Std Err	Std Dev	CV%	%Effect
0	LW	5	1.58	1.26	1.9	1.14	1.76	0.116	0.259	16.44%	0.00%
56		5	1.73	1.56	1.9	1.53	1.86	0.062	0.139	8.03%	-9.46%
100		5	1.71	1.37	2.05	1.3	2.04	0.123	0.276	16.13%	-8.39%
180		5	1.35	0.885	1.82	0.908	1.94	0.169	0.378	27.94%	14.14%
320		5	0.184	-0.0493	0.417	0	0.428	0.084	0.188	102.11%	88.34%
560		5	0	0	0	0	0	0	0	---	100.00%
1000		5	0	0	0	0	0	0	0	---	100.00%

CETIS Summary Report

Report Date: 08 Sep-20 09:09 (p 2 of 2)
 Test Code/ID: 89626 / 11-3958-2180

Chronic Larval Fish Survival and Growth Test

Pacific EcoRisk

7d Survival Rate Detail							MD5: D000A05B49FA22EF063F73B4DAEFEB84
Conc-µg/L	Code	Rep 1	Rep 2	Rep 3	Rep 4	Rep 5	
0	LW	1.000	1.000	1.000	1.000	0.750	
56		1.000	1.000	1.000	1.000	1.000	
100		1.000	1.000	1.000	1.000	0.800	
180		0.800	0.800	1.000	1.000	0.600	
320		0.200	0.400	0.200	0.000	0.000	
560		0.000	0.000	0.000	0.000	0.000	
1000		0.000	0.000	0.000	0.000	0.000	

Mean Dry Biomass-mg Detail							MD5: 0598E09B90FCAE324757E84D505B924F
Conc-µg/L	Code	Rep 1	Rep 2	Rep 3	Rep 4	Rep 5	
0	LW	1.76	1.69	1.55	1.76	1.14	
56		1.86	1.65	1.86	1.53	1.73	
100		1.66	1.68	1.87	2.04	1.3	
180		1.4	1.19	1.94	1.33	0.908	
320		0.302	0.428	0.19	0	0	
560		0	0	0	0	0	
1000		0	0	0	0	0	

7d Survival Rate Binomials						
Conc-µg/L	Code	Rep 1	Rep 2	Rep 3	Rep 4	Rep 5
0	LW	5/5	5/5	5/5	5/5	3/4
56		5/5	5/5	5/5	5/5	5/5
100		5/5	5/5	5/5	5/5	4/5
180		4/5	4/5	5/5	5/5	3/5
320		1/5	2/5	1/5	0/5	0/5
560		0/5	0/5	0/5	0/5	0/5
1000		0/5	0/5	0/5	0/5	0/5

Chronic Larval Fish Survival and Growth Test

Pacific EcoRisk

Test Type: Growth-Survival (7d)
 Protocol: EPA/600/R-95/136 (1995)

Organism: Atherinops affinis
 Endpoint: 7d Survival Rate

Material: Copper chloride
 Source: Reference Toxicant-REF

Chronic Larval Fish Survival and Growth Test

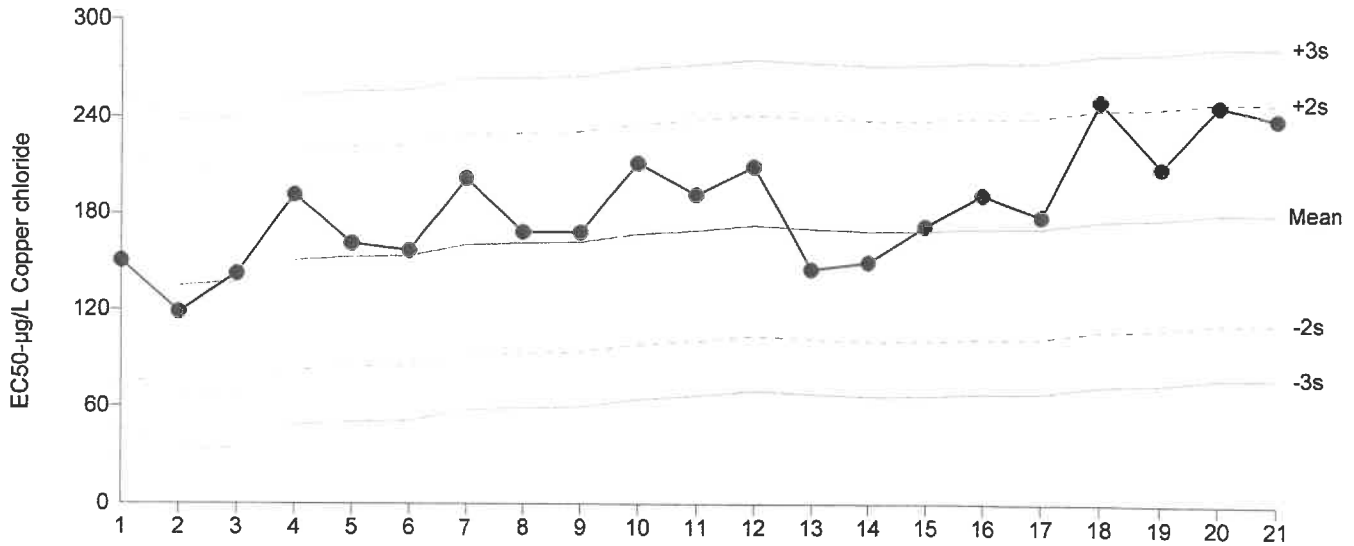

Mean: 180.8 Count: 20 -2s Warning Limit: 112.4 -3s Action Limit: 78.22
 Sigma: 34.2 CV: 18.90% +2s Warning Limit: 249.2 +3s Action Limit: 283.4

Quality Control Data

Point	Year	Month	Day	Time	QC Data	Delta	Sigma	Warning	Action	Test ID	Analysis ID
1	2017	Mar	21	14:30	150.6	-30.19	-0.8828			20-6326-4170	01-2850-5128
2		Apr	27	15:20	118.8	-61.99	-1.813			12-5173-5100	18-2281-7403
3		May	6	15:10	142.4	-38.4	-1.123			00-9957-1385	04-8504-7742
4		Jun	13	14:20	191.7	10.9	0.3188			00-7889-2529	02-3682-4376
5		Jul	13	14:35	161.3	-19.48	-0.5696			17-8123-4418	08-8465-2146
6		Aug	3	15:00	157	-23.81	-0.6963			20-6811-8584	03-9822-6188
7		Oct	12	15:15	201.8	21.01	0.6142			00-4593-9500	19-0349-6831
8		Nov	9	15:30	168.5	-12.33	-0.3605			05-6312-9853	18-7161-6014
9	2018	Feb	15	15:35	168.4	-12.42	-0.3631			11-8054-5553	18-0166-5915
10			27	17:21	211.5	30.67	0.8969			16-6236-6224	01-9640-0272
11		Aug	21	16:01	191.8	11.04	0.3228			00-3551-6424	13-5488-9353
12		Nov	13	15:15	209.4	28.59	0.8359			08-7960-8695	13-5404-7260
13		Dec	14	16:24	145.5	-35.33	-1.033			17-3206-9966	05-5424-1058
14	2019	Jul	16	14:50	150	-30.82	-0.9011			17-3501-9465	09-5525-4882
15		Aug	13	15:30	172.2	-8.558	-0.2502			15-4480-3505	05-7166-6556
16		Nov	5	13:35	191.6	10.75	0.3144			13-9458-1338	04-2098-4687
17	2020	Feb	4	16:05	178.4	-2.4	-0.07019			17-0836-0501	15-9061-3756
18		Mar	10	13:47	249.6	68.78	2.011	(+)		11-5597-1693	08-0875-1722
19		Apr	21	16:40	208.8	28.05	0.8201			03-1033-9159	06-0715-2387
20		May	28	14:20	247.1	66.3	1.939			21-1186-7616	13-2198-9798
21		Aug	25	13:20	239.7	58.87	1.721			11-3958-2180	08-1159-7549

Chronic Larval Fish Survival and Growth Test

Pacific EcoRisk

Test Type: Growth-Survival (7d)
 Protocol: EPA/600/R-95/136 (1995)

Organism: Atherinops affinis
 Endpoint: Mean Dry Biomass-mg

Material: Copper chloride
 Source: Reference Toxicant-REF

Chronic Larval Fish Survival and Growth Test

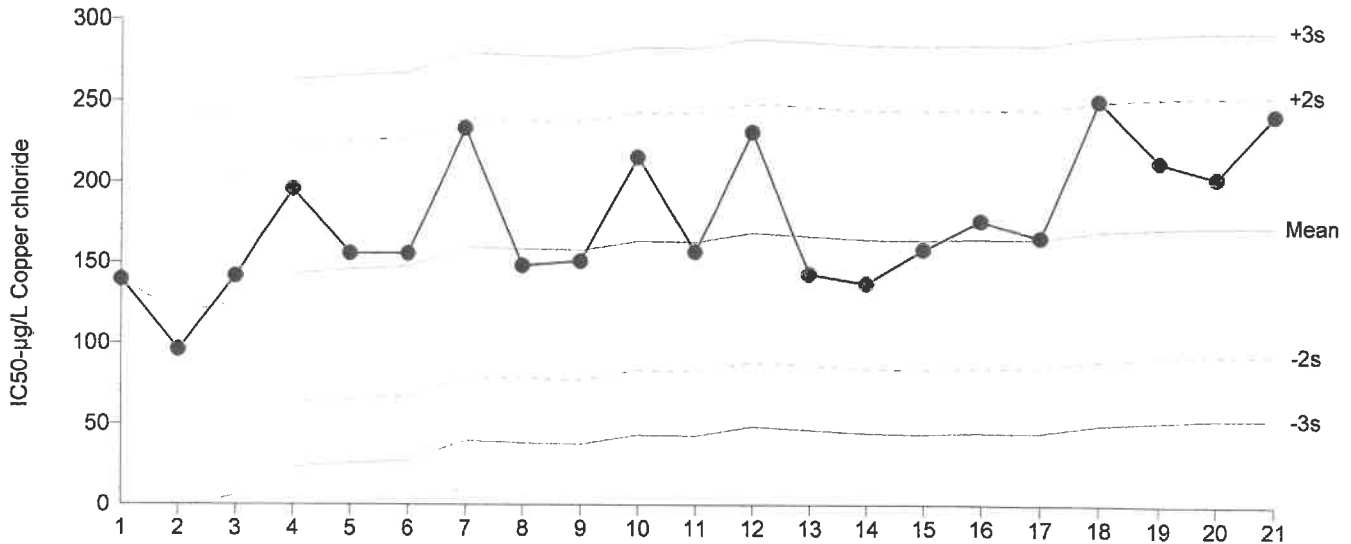

Mean: 173.1 Count: 20 -2s Warning Limit: 93.2 -3s Action Limit: 53.24
 Sigma: 39.96 CV: 23.10% +2s Warning Limit: 253 +3s Action Limit: 293

Quality Control Data

Point	Year	Month	Day	Time	QC Data	Delta	Sigma	Warning	Action	Test ID	Analysis ID
1	2017	Mar	21	14:30	139.4	-33.67	-0.8427			20-6326-4170	03-3854-1324
2		Apr	27	15:20	95.92	-77.18	-1.931			12-5173-5100	15-1911-6681
3		May	6	15:10	141.6	-31.53	-0.789			00-9957-1385	17-5803-8095
4		Jun	13	14:20	195.6	22.48	0.5625			00-7889-2529	14-9330-6229
5		Jul	13	14:35	155.5	-17.63	-0.4412			17-8123-4418	15-5385-4800
6		Aug	3	15:00	155.4	-17.73	-0.4437			20-6811-8584	15-9739-7007
7		Oct	12	15:15	233.1	60.01	1.502			00-4593-9500	13-4527-3547
8		Nov	9	15:30	147.9	-25.24	-0.6316			05-6312-9853	20-2765-5437
9	2018	Feb	15	15:35	150.7	-22.41	-0.5608			11-8054-5553	01-8976-9291
10			27	17:21	215.4	42.3	1.059			16-6236-6224	10-5519-5225
11		Aug	21	16:01	156.3	-16.75	-0.4192			00-3551-6424	11-2151-1794
12		Nov	13	15:15	230.8	57.72	1.444			08-7960-8695	19-6606-9199
13		Dec	14	16:24	142.7	-30.42	-0.7612			17-3206-9966	02-7400-4954
14	2019	Jul	16	14:50	136.8	-36.31	-0.9086			17-3501-9465	17-6266-9199
15		Aug	13	15:30	157.8	-15.28	-0.3825			15-4480-3505	16-7106-5688
16		Nov	5	13:35	176.1	2.997	0.07499			13-9458-1338	11-3656-8793
17	2020	Feb	4	16:05	165.4	-7.659	-0.1917			17-0836-0501	20-9405-0607
18		Mar	10	13:47	250.5	77.37	1.936			11-5597-1693	02-2835-2295
19		Apr	21	16:40	212.6	39.52	0.9891			03-1033-9159	02-9828-7179
20		May	28	14:20	203	29.92	0.7488			21-1186-7616	14-4986-5213
21		Aug	25	13:20	242	68.94	1.725			11-3958-2180	09-7913-6021

7 Day Chronic Topsmelt (*A. affinis*) Reference Toxicant Test Data

Client: Pacific EcoRisk Organism Log#: 12273 Age: 14d
 Test Material: Copper (as cupric chloride) Organism Supplier: ABS
 Test ID#: 89626 Project #: 32041 Control/Diluent: Filtered Seawater
 Test Date: 8/25/20 Randomization: 5.7.5 Control Water Batch: —

Treatment (µg/L Cu)	Temp (°C)	pH		D.O. (mg/L)		Salinity (ppt)		# Live Organisms					SIGN-OFF	
		new	old	new	old	new	old	A	B	C	D	E		
Control	20.7	7.62		8.3		33.9		5	5	5	5	5	4	Date: 8/25/20
56	20.7	7.46		8.4		34.1		5	5	5	5	5	5	Sample ID: —
100	20.6	7.10		8.5		34.3		5	5	5	5	5	5	Test Solution Prep: —
180	20.7	7.07		8.4		34.2		5	5	5	5	5	5	New WQ: —
320	20.6	7.17		8.2		34.3		5	5	5	5	5	5	Initiation Time: 1320
560	20.5	7.14		8.2		34.1		5	5	5	5	5	5	Initiation Signoff: —
1000	20.7	7.14		8.4		34.1		5	5	5	5	5	5	
Meter ID:	59A	PH15		RD13		EC12								
Control	20.6	7.68	7.40	7.7	3.6	34.7	34.9	5	5	5	5	5	4	Date: 8/26/20
56	20.6	7.69	7.32	8.1	2.1	34.8	35.0	5	5	5	5	5	5	Sample ID: —
100	20.8	7.70	7.52	8.1	4.4	34.8	35.2	5	5	5	5	5	5	Test Solution Prep: —
180	20.8	7.70	7.59	8.2	4.5	34.6	35.0	4	4	5	5	5	5	New WQ: —
320	20.8	7.70	7.61	8.0	5.8	34.7	35.2	2	2	1	0	0	0	Renewal Time: 1144
560	20.8	7.69	7.55	8.1	5.3	34.6	34.9	0	0	0	0	0	0	Renewal-Sign-off: —
1000	20.6	7.66	7.66	8.3	5.2	34.5	34.8	0	0	0	0	0	0	Old WQ: —
Meter ID:	97A	PH26	PH26	RD14	RD14	EC14	EC14							
Control	20.7	7.67	7.40	8.1	5.0	33.6	34.8	5	5	5	5	5	4	Date: 8/27/20
56	21.0	7.72	7.36	7.9	4.4	33.9	35.1	5	5	5	5	5	5	Sample ID: —
100	20.8	7.74	7.46	8.0	5.0	33.8	34.9	5	5	5	5	5	4	Test Solution Prep: —
180	20.8	7.76	7.40	8.3	4.6	33.7	35.0	4	4	5	5	5	4	New WQ: —
320	21.0	7.74	7.43	8.2	4.6	34.0	34.9	2	2	1	—	—	—	Renewal Time: 1340
560	—	—	—	—	—	—	—	—	—	—	—	—	—	Renewal-Sign-off: —
1000	—	—	—	—	—	—	—	—	—	—	—	—	—	Old WQ: —
Meter ID:	116A	PH25	PH26	RD12	RD14	EC13	EC14							
Control	19.7	7.54	7.65	8.0	5.7	33.5	36.4	5	5	5	5	5	4	Date: 8/28/20
56	19.7	7.60	7.62	8.3	5.8	33.9	35.1	5	5	5	5	5	5	Sample ID: —
100	19.7	7.63	7.61	8.4	5.8	33.8	35.0	5	5	5	5	5	4	Test Solution Prep: —
180	19.5	7.64	7.62	8.5	5.9	33.9	34.8	4	4	5	5	5	3	New WQ: —
320	19.2	7.64	7.65	8.3	6.2	33.9	33.9	2	2	1	—	—	—	Renewal Time: 1105
560	—	—	—	—	—	—	—	—	—	—	—	—	—	Renewal-Sign-off: —
1000	—	—	—	—	—	—	—	—	—	—	—	—	—	Old WQ: —
Meter ID:	114A	PH24	PH25	RD14	KB13	EC13	EC11							

7 Day Chronic Topsmelt (*A. affinis*) Reference Toxicant Test Data

Client: Pacific EcoRisk Organism Log#: 12273 Age: 14d
 Test Material: Copper (as cupric chloride) Organism Supplier: ABS
 Test ID#: 89626 Project #: 321 Control/Diluent: Filtered Seawater
 Test Date: 8/25/20 Randomization: S.7.5 Control Water Batch: -

Treatment (µg/L Cu)	Temp (°C)	pH		Diss. O ₂ (mg/L)		Salinity (ppt)		# Live Organisms					SIGN-OFF
		new	old	new	old	new	old	A	B	C	D	E	
Control	20.1	7.66	7.70	7.7	6.7	34.4	37.3	5	5	5	5	4	Date: 8/29/20
56	19.9	7.65	7.65	7.8	6.3	34.5	37.4	5	5	5	5	5	Sample ID: -
100	19.3	7.67	7.66	7.9	6.1	34.6	38.6	5	5	5	5	4	Test Solution Prep: TK
180	19.0	7.67	7.63	7.9	6.1	34.6	38.4	4	4	5	5	3	New WQ: CC
320	18.3	7.66	7.74	8.0	6.4	34.6	39.4	1	2	1	-	-	Renewal Time: 1254
560	-	-	-	-	-	-	-	-	-	-	-	-	Renewal Sign-off: RB
1000	-	-	-	-	-	-	-	-	-	-	-	-	Old WQ: TA
Meter ID:	105A	PH15	PH26	RD12	RD13	EC12	EC12						
Control	20.2	7.69	7.70	8.0	6.4	34.8	36.3	5	5	5	5	4	Date: 8/30/20
56	20.0	7.80	7.72	7.9	6.4	34.8	36.2	5	5	5	5	5	Sample ID: -
100	19.9	7.82	7.72	8.0	6.4	34.9	36.6	5	5	5	5	4	Test Solution Prep: CD
180	19.8	7.83	7.68	7.9	6.3	34.9	36.3	4	4	5	5	3	New WQ: dk
320	19.8	7.82	7.76	8.0	6.3	34.9	36.8	1	2	1	-	-	Renewal Time: 1439
560	-	-	-	-	-	-	-	-	-	-	-	-	Renewal Sign-off: JL
1000	-	-	-	-	-	-	-	-	-	-	-	-	Old WQ: AS
Meter ID:	59A	PH25	PH26	RD13	RD14	EC14	EC12						
Control	20.2	7.67	7.84	8.0	6.8	34.1	34.9	5	5	5	5	3	Date: 8/31/20
56	20.1	7.76	7.80	8.6	6.8	33.8	35.4	5	5	5	5	5	Sample ID: -
100	20.0	7.76	7.80	8.7	6.6	34.0	35.5	5	5	5	5	4	Test Solution Prep: TK
180	19.9	7.75	7.83	8.6	6.7	34.0	35.2	4	4	5	5	3	New WQ: dk
320	19.9	7.74	7.87	8.5	6.8	33.9	35.4	1	2	1	-	-	Renewal Time: 1230
560	-	-	-	-	-	-	-	-	-	-	-	-	Renewal Sign-off: TK
1000	-	-	-	-	-	-	-	-	-	-	-	-	Old WQ: DD
Meter ID:	59A	PH26	PH26	RD10	RD10	EC12	EC11						
Control	20.0	-	7.78	-	6.9	-	34.7	5	5	5	5	3	Date: 9/1/20
56	19.9	-	7.75	-	6.8	-	35.2	5	5	5	5	5	Termination Time: 0845
100	19.8	-	7.76	-	6.6	-	35.2	5	5	5	5	4	Termination Sign-off: JL
180	19.8	-	7.79	-	6.7	-	35.3	4	4	5	5	3	Old WQ: RD
320	19.8	-	7.84	-	7.0	-	35.4	1	2	1	-	-	
560	-	-	-	-	-	-	-	-	-	-	-	-	
1000	-	-	-	-	-	-	-	-	-	-	-	-	
Meter ID:	113A	-	PH24	-	RD12	-	EC12						

Topsmelt (A. affinis) Dry Weight Data Sheet

Client: Reference Toxicant Test ID #: 89626 Project # 32041
 Test Material: Copper (as cupric chloride) Tare Weight Date: 8/26/20 Sign-off: DKB
 Test Date: 8/25/20 Final Weight Date: 9/7/20 Sign-off: DKB

Pan ID	Concentration	Replicate	Initial Pan Weight (mg)	Final Pan Weight (mg)	Initial # of Organisms	Biomass Value (mg)
1	Control	A	409.15	417.945	5	
2		B	408.61	417.04	5	
3		C	411.94	419.68	5	
4		D	413.64	422.43	5	
5		E	408.49	413.05	4	
6	56	A	408.26	417.54	5	
7		B	414.12	422.39	5	
8		C	417.54	426.84	5	
9		D	409.06	416.73	5	
10		E	418.24	426.90	5	
11	100	A	416.42	^{DKB} ^{9/7/20} 412.55 424.71	5	
12		B	411.77	420.15	5	
13		C	413.47	422.84	5	
14		D	409.29	419.49	5	
15		E	414.36	420.88	5	
16	180	A	413.93	420.93	5	
17		B	413.13	419.10	5	
18		C	412.89	422.60	5	
19		D	407.07	413.72	5	
20		E	416.51	421.05	5	
21	320	A	408.68	410.19	5	
22		B	408.45	410.59	5	
23		C	417.34	418.29	5	
24		D	405.86	^{SV} ^{9/18/20} 410.81 -	5	
25		E	409.01	^{SV} ^{9/18/20} 408.96 -	5	
26	560	A	407.99	^{SV} ^{9/18/20} 407.92 -	5	
27		B	409.42	^{SV} ^{9/18/20} 409.36 -	5	
28		C	414.79	^{SV} ^{9/18/20} 414.76 -	5	
29		D	408.67	^{SV} ^{9/18/20} 408.56 -	5	
30		E	410.91	^{SV} ^{9/18/20} 410.82 -	5	
31	1000	A	414.42	^{SV} ^{9/18/20} 414.44 -	5	
32		B	414.42	^{SV} ^{9/18/20} 414.40 -	5	
33		C	414.38	^{SV} ^{9/18/20} 414.41 -	5	
34		D	410.80	^{SV} ^{9/18/20} 410.76 -	5	
35		E	414.42	^{SV} ^{9/18/20} 414.51 -	5	
QA1			409.70	409.67		
QA2			412.64	412.61		
QA3			414.93	414.95		
Balance ID:			BAL 04	BAL 04		

Appendix E:

Local Limits Study

TECHNICALLY BASED LOCAL LIMIT STUDY

for

**Crescent City Wastewater Treatment Facility (WWTF)
210 Battery Street
Crescent City, California
NPDES No. CA0022756**

Prepared for:
The City of Crescent City
377 J Street
Crescent City, California 95531

July 2020

Prepared by:
Orrin Plocher and Stan Thiesen

of



Freshwater Environmental Services

78 Sunny Brae Center
Arcata, California 95521
Phone (707) 839-0091

TABLE OF CONTENTS

APPENDIX.....	iii
1.0 INTRODUCTION	1
2.0 WASTEWATER MANAGEMENT FACILITY DESCRIPTION.....	2
2.1 Facility, Location and Ownership.....	2
2.2 Facility Description	2
2.3 Collection System Description.....	2
3.0 EXISTING LOCAL LIMITS AND DEVELOPMENT APPROACH	3
4.0 POLLUTANTS OF CONCERN	4
5.0 SAMPLING AND MONITORING.....	6
5.1 Treatment Plant Sampling.....	6
5.2 Collection System Sampling.....	7
5.3 Sample Handling	7
5.4 Analytical Methods and Results	7
5.5 Quality Assurance/Quality Control.....	8
6.0 FLOW DATA	9
6.1 Total POTW Flow	9
6.2 Sludge Flow to Disposal.....	9
6.3 Flows from Controlled Sources	9
6.4 Flows from Uncontrolled Sources.....	9
7.0 CALCULATING THE MAXIMUM ALLOWABLE HEADWORKS LOADING ..	10
7.1 Calculating Removal Efficiencies	10
7.2 Calculating Allowable Headworks Loading.....	12
7.3 Designation of Maximum Allowable Headworks Loading	13
7.4 Calculation of Maximum Allowable Industrial Loading.....	13
8.0 DESIGNATING AND IMPLEMENTING LOCAL LIMITS	15
8.1 Actual Loadings vs. MAHL	15
8.2 Ammonia Nitrogen Total.....	16

8.3 Oil and Grease 16

8.4 Chromium Total..... 16

8.5 Copper 17

8.6 Silver 17

8.7 Proposed Local Limits 17

9.0 REFERENCES 19

APPENDIX

- APPENDIX A LABORATORY RESULTS
- APPENDIX B EPA Region 5 MAHL SPREADSHEET
- APPENDIX C Biosolids Copper TTLC And STLC Laboratory Reports

1.0 INTRODUCTION

Federal water quality regulations require local governments to prevent the introduction of certain pollutants into their Publicly Owned Treatment Works (POTW), in order to prevent interference with wastewater treatment processes and pass through of pollutants, and provide for the use and disposal of municipal biosolids (sludge). This is accomplished through development and implementation of specific effluent limits (local limits) for industrial users. These limits are developed to reflect the specific needs and capabilities at individual POTWs and protect the waterbody to which the POTW discharges.

Freshwater Environmental Services (FES) assisted Crescent City (the City) to develop a *Local Limits Development Workplan for Crescent City Wastewater Treatment Facility (WWTF)* (FES, 2017). The California Regional Water Quality Control Board North Coast Region reviewed the workplan and provided comments. The workplan was updated in 2018 incorporating edits based on the California Regional Water Quality Control Board North Coast Region comments. Sampling was performed per the workplan updated in 2018.

The workplan, sampling, and study were prepared and conducted following the general principals contained in EPA's 2004 *Local Limits Development Guidance* (EPA, 2004).

This Study contains the following elements:

- The Wastewater Treatment Facility (WWTF) and collection system is described in Section 2.0;
- The existing local limits and development approach is presented in Section 3.0;
- The pollutants of concern are presented in Section 4.0;
- The sampling and analysis are described in Section 5.0;
- Removal efficiencies are calculated in Section 6.0;
- Maximum allowable headworks loading (MAHL) is calculated in Section 7.0;
- Allocation of MAHL to Industrial Users is presented in Section 8.0; and
- The references cited in this report are listed in Section 9.0.

2.0 WASTEWATER MANAGEMENT FACILITY DESCRIPTION

2.1 Facility, Location and Ownership

Crescent City owns and operates a (WWTF) located at 210 Battery Street in Crescent City, Del Norte County, California. Discharges from the WWTF are regulated by National Pollution Discharge Elimination System (NPDES) permit number **CA0022756**.

2.2 Facility Description

Information within the NPDES permit indicates that the City of Crescent City owns a wastewater collection, treatment, and disposal facility with a design average dry weather treatment capacity of 1.86 million gallons per day (MGD) for treating domestic/commercial, and industrial wastewater. The collection system service area includes the City of Crescent City and the County Service Area, which includes a total population of 15,573.

Treatment processes at the Crescent City WWTF consist of headworks, including a mechanically cleaned screen, a Parshall flume, and a wet well; primary treatment, including two grit removal tanks and two clarifiers; and secondary treatment. Secondary treatment is provided by operating rotating biological contactors and a membrane bioreactor in parallel. Flows from the rotating biological contactors and flow from the membrane bioreactor are commingled and disinfected and dechlorinated. Effluent is discharged to the Pacific Ocean. The 24-inch diameter ductile iron pipe outfall discharges into a rocky slot in the surf zone adjacent to the Battery Point Lighthouse and has an effluent conveyance capacity up to 13 MGD.

Solids handling consists of gravity thickening of primary sludge, rotary drum thickening of secondary sludge, and anaerobic digestion of thickened sludge. Dewatered solids are currently placed in a landfill.

2.3 Collection System Description

The Crescent City collection system has some unique characteristics that affect the local limits approach. The collection system is dominated by domestic/commercial users. There are currently three Significant Industrial Users (SIU), Porta 'O Pints Brewing Company, SeaQuake Brewing, and Rumiano Cheese. A seasonal seafood processor has been evaluated and it has been determined that a discharge permit is not warranted. Commercial dischargers include Food Service Establishments (FSEs) that generate Fats, Oils and Greases (FOG). Beyond FSEs, commercial users are limited in numbers and potential impact. Non-FOG commercial users with the potential to impact the system are limited.

3.0 EXISTING LOCAL LIMITS AND DEVELOPMENT APPROACH

The City of Crescent City's existing local limits are shown in the Table below. The existing Crescent City local limits were developed based on the *Crescent City Technical Basis for Wastewater Limits*, (FES, 2012), and reevaluation of BOD and TSS in 2016 and are shown in the table below.

Pollutant	Local Limit in (mg/L) ppm
Ammonia	32.0
Copper	0.086
Lead	0.0037
Nickel	0.0044
Oil and Grease (total)	100
bis (2-ethylhexyl) phthalate	0.0096
Zinc	0.0033

Pollutant	Local Limit, Maximum Allowable Industrial Loading (MAIL) pounds/day
BOD	2641
TSS	4282

The City has reevaluated the existing local limits to determine if they are still protective of the POTW or need to be modified. The City used the Maximum Allowable Headworks Loading (MAHL) calculation methodology generally described in EPA's 2004 *Local Limits Development Guidance* to establish its revised local limits. The MAHL methodology includes four basic steps:

- Determine the Pollutants of Concern (POC);
- Collect and analyze data;
- Calculate MAHLs for each POC; and
- Designate and implement the local limits.

The City used a spreadsheet-based model developed by Region 5 U.S. Environmental Protection Agency's (USEPA) to facilitate calculation of AHLs (Allowable Headworks Loading), MAHLs, and the proposed local limits consistent with the methodology contained in EPA's 2004 *Local Limits Development Guidance*.

After completing the MAHL methodology, local limits were adjusted to address collection system concerns and practical considerations.

4.0 POLLUTANTS OF CONCERN

A Pollutant of Concern (POC) is any pollutant that may be discharged to the POTW in sufficient amounts to pass through treatment processes, interfere with treatment processes, jeopardize worker health and safety, or cause operational problems. POCs may also include pollutants in the applicable NPDES permit or biosolids quality regulations. In order to determine the POCs to be evaluated, the City considered the following:

- Crescent City NPDES permit requirements;
- Biosolids quality regulations;
- Treatment process inhibition;
- Water Quality Criteria (California Ocean Plan, 2019);
- Known Industrial Users;
- Sampling and violation history at the WWTF;
- California hazardous waste criteria;
- Current local limits; and
- EPA guidance documents.

Based on an evaluation of all compounds detected in influent samples since 2008, all compounds detected in effluent samples since the treatment system was optimized in 2010, a list of potential POCs with driving factors for further consideration was developed and resulted in a list of final POCs shown in the table below:

Pollutant of Concern
Conventional
Oil and Grease
Turbidity (NTU)
Settleable Solids (mg/L)
Ammonia Nitrogen total (as N)
Priority Pollutants Metals, Sulfur Compounds & Cyanide
Arsenic
Cadmium
Total Chromium
Copper
Cyanide
Lead
Molybdenum
Mercury
Nickel
Sulfate
Sulfide
Selenium
Silver
Zinc

Organic Compounds
bis(2-ethylhexyl phthalate)
Dieldrin

5.0 SAMPLING AND MONITORING

All sampling was conducted under normal operating conditions during dry weather over the period of September 4, 2019 to September 11, 2019. Sampling followed the flow of the treatment process based on the hydraulic residence time (i.e., effluent sampling was conducted after influent sampling and lagged by the hydraulic residence time of approximately 4 hours). Specific sampling for local limits development was determined following an extensive review of existing data and potential non-domestic sources. The City also provided actual flow data regarding total POTW commercial/domestic wastewater flow, industrial wastewater flow, flow of sludge to the digesters, and flow of biosolids to disposal. The City used this data to calculate the load of each POC coming into the POTW. Wastewater samples were 24-hour, time-composited samples. Time composite samples consisted of hourly subsamples collected over a 24-hour period. Sulfide and oil and grease samples were grab composite samples. Individual grab samples that were collected for the grab composite samples were handled, preserved, and composited in accordance with the guidance on pages 4-9 of the USEPA Guidance document. Aliquots were collected in separate containers, preserved appropriately, and composited manually at the laboratory to create a single sample for analysis.

Crescent City collected wastewater samples for seven consecutive days to characterize the changes in loading. Biosolids were sampled for 2 days, one weekday and one weekend day.

The local limits sampling locations include:

Treatment Plant Sampling:

- Headworks Influent (1 location)
- Final Effluent (1 location)
- Biosolids (dewatering facility)

Collection System Sampling:

- Domestic/commercial Collection System, (2 location)
- Industrial data was based on existing data from the three Significant Industrial Users (SIUs).

5.1 Treatment Plant Sampling

Influent samples and effluent samples were collected over 7 consecutive days separated by 4 hours (calculated hydraulic residence time) and analyzed for the POCs. Influent sampling was collected at a location prior to mixing with other wastewater streams.

Biosolids were sampled just prior to disposal over a two-day period within the week of influent/effluent sampling. The biosolid samples were manually composited over eight hours using equal hourly aliquots. Biosolid aliquots were collected into one container which were stored in the wastewater laboratory refrigerator. The eight-hour biosolid composite samples were homogenized and divided into the appropriate laboratory bottles at the end of each day and stored in the lab refrigerator overnight.

Except for copper, the maximum concentrations of metals in the biosolids samples are all less than 10 times the California STLC limits and therefore are not able to leach

metals at concentrations that would make them a California hazardous waste. Copper in biosolids was further evaluated by having additional samples analyzed for leachable copper to determine STLC. Leachable copper was found to be less than the method detection limit and less than the California STLC limit for hazardous waste. Laboratory reports are contained in Appendix C.

Likewise, the maximum metals results are less than 20 times the EPA TCLP limits and therefore are not able to leach metals at concentrations that would make them an EPA hazardous waste. Additional analysis for characterization of hazardous waste is not warranted.

Sampling documentation did not note any infrequent, yet routine, activities occur during the sampling period. Examples of infrequent, yet routine, activities include receipt of hauled waste, tank cleaning, or other maintenance activities that might affect wastewater characteristics.

5.2 Collection System Sampling

Samples from two locations within the collection system were collected for seven consecutive days and analyzed for the POCs. The samples were from locations of predominantly domestic/commercial discharge. The sampling within the collection system was performed within the same seven-day period of influent/effluent sampling at the treatment plant.

5.3 Sample Handling

Wastewater samples were collected in laboratory provided containers labeled and immediately placed in an ice-cooled chest for delivery to an analytical laboratory certified by the California Department of Health Services for the required analyses. All sample handling included chain-of-custody documentation.

5.4 Analytical Methods and Results

All wastewater samples were analyzed utilizing the methods indicated in the table below:

Potential Pollutant of Concern	Analytical Method
Conventional	
Turbidity	SM 2130 B
Settleable Matter	SM 2540 F
Ammonia	SM 4500 NH3 B/C
Oil and Grease	EPA 1664A
Priority Pollutants Metals & Cyanide	
Arsenic	EPA 200.8
Cadmium	EPA 200.8
Total Chromium	EPA 200.8
Copper	EPA 200.8
Cyanide	SM 4500CN E
Lead	EPA 200.8
Molybdenum	EPA 200.8
Mercury	EPA 1631E
Nickel	EPA 200.8
Selenium	EPA 200.8
Silver	EPA 200.8
Zinc	EPA 200.8
Organics	
bis(2-ethylhexyl phthalate)	EPA Method 625
Dieldrin	EPA Method 8081
Sulfur Compounds	
Sulfate	EPA 300.0
Sulfide	SM 4500 S2 D

All biosolid samples were analyzed utilizing the methods indicated in the table below:

Potential Pollutant of Concern	Analytical Method
Conventional	
Priority Pollutants Metals & Cyanide	
Arsenic	EPA 6010B
Cadmium	EPA 6010B
Total Chromium	EPA 6010B
Copper	EPA 6010B
Cyanide	EPA 9010C/9014
Lead	EPA 6010B
Molybdenum	EPA 6010B
Mercury	EPA 7471A
Nickel	EPA 6010B
Selenium	EPA 6010B
Silver	EPA 6010B
Zinc	EPA 6010B

The laboratory results for each POC are included in Appendix A.

5.5 Quality Assurance/Quality Control

Following receipt of the laboratory analytical report all laboratory QC batches were checked to ensure that the correct number of samples were analyzed, the holding times were not exceeded, surrogate recoveries were within stated control limits, and that Laboratory Method Blanks, Matrix Spikes (MSs), Matrix Spike Duplicates (MSDs), Laboratory Control Samples (LCSs) and Laboratory Control Sample Duplicates (LCSDs) were all tested and within the laboratory-provided acceptable limits.

6.0 FLOW DATA

To calculate MAHLs and Maximum Allowable Industrial Loading (MAILs), data about the flow of various wastestreams is required to allow mass quantities to be computed. Required flow data are described in the following sections.

6.1 Total POTW Flow

The average daily influent flow for the past 12 months (Nov 2018 – Oct 2019) (1.461 MGD) was used as Total POTW flow (Q_{potw}) for loading calculations as shown below:

$$Q_{\text{potw}} = 1.461 \text{ MGD}$$

6.2 Sludge Flow to Disposal

The average daily flow of all volume of sludge from digester to belt press for the past 12 months (Nov 2018 – Oct 2019) (0.228 MGD) was used as (Q_{sldg}) for loading calculations.

$$Q_{\text{sldg}} = 0.228 \text{ MGD}$$

6.3 Flows from Controlled Sources

Crescent City has three significant industrial users (SIUs) that discharged wastewater estimated at an average of 0.048 MGD in 2019.

6.4 Flows from Uncontrolled Sources

Flows from uncontrolled sources to be used in loading calculations was estimated by subtracting the industrial flow from the total POTW flow 1.266 MGD.

7.0 CALCULATING THE MAXIMUM ALLOWABLE HEADWORKS LOADING

The Maximum Allowable Headworks Loading (MAHL) is the estimated maximum loading of a pollutant that can be received by a POTW without inhibiting treatment processes or exceeding any applicable environmental criteria. The City followed the steps below to determine the MAHL for each POC:

1. Determine the removal efficiencies for each POC;
2. Calculate the Allowable Headworks Loading (AHL) for each POC, for all applicable environmental criteria, based on influent flow rates and POC removal efficiencies; and
3. Designate the MAHL as the strictest AHL.

The City used a spreadsheet-based model developed by the U.S. Environmental Protection Agency's (USEPA) Region 5 to facilitate calculation of AHLs, MAHLs, and the proposed local limits (Appendix B).

7.1 Calculating Removal Efficiencies

The City calculated POTW removal efficiency utilizing the formula for Mean Removal Efficiency (MRE) and Average Daily Removal Efficiency (ADRE).

Removal Efficiency Calculated Using Mean Removal Efficiency)	
RPOTW=	(Ir-EPOTW) / (Ir)
RPOTW	Plant removal efficiency from headworks to plant effluent, as decimal.
Ir	POTW influent pollutant concentration mg/l
EPOTW	POTW effluent pollutant concentration mg/l

Equation 5.1: Removal Efficiency Calculated Using Average Daily Removal Efficiency

$$R_{potw} = \frac{\sum(I_n - E_{potw,n})/I_n}{N}$$

$$R_{prim} = \frac{\sum(I_n - E_{prim,n})/I_n}{N}$$

$$R_{sec} = \frac{\sum(I_n - E_{sec,n})/I_n}{N}$$

Where:

R_{potw} = Plant removal efficiency from headworks to plant effluent, as decimal
 R_{prim} = Removal efficiency from headworks to primary treatment effluent, as decimal
 R_{sec} = Removal efficiency from headworks to secondary treatment effluent, as decimal
 I_n = POTW influent pollutant concentration at headworks, mg/L
 $E_{potw,n}$ = POTW effluent pollutant concentration, mg/L
 $E_{prim,n}$ = Primary treatment effluent pollutant concentration, mg/L
 $E_{sec,n}$ = Secondary treatment effluent pollutant concentration, mg/L
 n = Paired observations, numbered 1 to N

MREs or ADREs were not calculated for the POCs listed below for the following reasons:

Pollutant of Concern	Comments from Data Set
Priority Pollutants Metals, sulfur compounds & Cyanide	
Cyanide	All NDs or J-flags
Lead	Single detection in collection system
Mercury	Single detection in influent
Sulfate	Sulfate is generated as part of the wastewater treatment process. Effluent concentrations were always greater than influent concentrations.
Sulfide	No treatment plant or environmental criterion.
Selenium	All NDs
Organic Compounds	
Dieldrin	All NDs

MREs or ADREs for the remaining POCs are listed below:

Pollutant of Concern	Comments from Data Set	Removal Efficiency	Method
Conventional			
Oil and Grease		53.17%	MRE
Turbidity (NTU)		94.81%	MRE
Settleable Solids (mL/L)		99.60%	MRE
Ammonia Nitrogen total (as N)		56.56%	MRE
Priority Pollutants Metals			
Arsenic	Negative removal efficiencies were removed for calculation of ADRE	15.52%	ADRE
Cadmium		51.48%	MRE
Total Chromium		9.17%	ADRE
Copper	Negative removal efficiencies were removed for calculation of ADRE.	28.17%	ADRE
Molybdenum	Negative removal efficiencies were removed for calculation of ADRE.	16.69%	ADRE
Nickel	Negative removal efficiencies were removed for calculation of ADRE.	7.56%	ADRE
Silver	Negative removal efficiencies were removed for calculation of ADRE.	12%	ADRE
Zinc		63%	MRE
Organic Compounds			
bis(2-ethylhexyl phthalate)		63%	MRE

7.2 Calculating Allowable Headworks Loading

Allowable Headworks Loading (AHL) is the estimated maximum loading of a pollutant that can be received at a POTW's headworks that should not cause a POTW to violate a particular treatment plant or environmental criterion. AHLs are developed to prevent interference or pass through.

After collecting and evaluating the necessary data, Crescent City calculated AHLs for each POC based on its treatment efficiency and on environmental criteria for pass through and interference. AHLs were calculated for each applicable criterion including:

- Effluent based criteria (NPDES ORDER NO. R1-2017-0002);
- Resource Protection Criteria (California Ocean Plan, 2019, State Water Board);
- Sludge based criteria (40 CFR Part 503).

The Crescent City has had no past inhibition problems at the WWTF. The City did not calculate AHLs to protect against inhibition because historic/current loadings have been acceptable to the treatment work's biological processes, and published inhibition factors for the processes in the WWTF are not available.

The following formulas were used to calculate AHLs:

<p>Allowable Headworks Loading (AHL) Based on NPDES Permit Limits</p> $AHL_{npdes} = (8.34)(C_{npdes})(Q_{potw}) / (1 - (R_{potw} / 100))$ <p>AHL_{npdes} = AHL based on NPDES permit limit, lb/day C_{npdes} = NPDES permit limit, mg/L Q_{potw} = POTW average flow rate, MGD R_{potw} = Plant removal efficiency from headworks to effluent, as percent. 8.34 = Conversion factor</p> <p>AHL Based on Water Quality Criteria</p> $AHL_{wq} = 8.349(C_{wq}(Q_{str}+Q_{potw})-(C_{str}Q_{str})) / (1 - (R_{potw} / 100))$ <p>AHL_{wq} = AHL based on water quality criteria, lb/day C_{str} = Receiving stream background concentration, mg/L (assumed to be zero since WQOs are specific discharge limits and not based on maximum cumulative loading) C_{wq} = State water quality criteria, mg/L Q_{str} = Receiving stream (upstream) flow rate, MGD (assumed to be 30 times the Q_{potw} since the previous NPDES permit had a 30:1 zone of initial dilution) Q_{potw} = POTW average flow rate, MGD R_{potw} = Plant removal efficiency from headworks to effluent, as percent. 8.34 = Conversion factor</p> <p>AHLs Based on Sludge Land Application and Surface Disposal Criteria (for conservative pollutants)</p> $AHL_{slgd} = (8.349)(C_{slgdstd})(PS/100)(Q_{slgd})(G_{slgd}) / R_{potw}$ <p>AHL_{slgd} = AHL based on sludge, lb/day C_{slgdstd} = Sludge standard, mg/kg dry sludge PS = Percent solids of sludge to disposal, as percent Q_{slgd} = Total sludge flow rate to disposal, MGD R_{potw} = Plant removal efficiency from headworks to effluent, as percent. G_{slgd} = Specific Gravity of sludge, kg/L 8.34 = Conversion factor</p>
--

7.3 Designation of Maximum Allowable Headworks Loading

Maximum Allowable Headworks Loading (MAHL) is the estimated maximum loading of a pollutant that can be received at a POTW's headworks without causing pass through or interference. MAHLs are the most protective (lowest) of the AHLs (see definition) estimated for a pollutant. The table below contains the MAHLs for the POCs and criteria:

Pollutant of Concern	Maximum Allowable Headworks Loading (lb/day)	Criteria
Conventional		
Oil and Grease	585	NPDES Monthly Limit
Turbidity (NTU)	15836	NPDES Monthly Limit
Settleable Solids (mL/L)	2740	NPDES Monthly Limit
Ammonia Nitrogen total (as N)	454	Chronic Water Quality Objectives
Priority Pollutants Metals, sulfur compounds & Cyanide		
Arsenic	1.98	Chronic Water Quality Objectives
Cadmium	0.68	Chronic Water Quality Objectives
Total Chromium	0.72	Chronic Water Quality Objectives
Copper	0.49	Chronic Water Quality Objectives
Molybdenum	134	40 CFR 503 Biosolids
Nickel	1.78	Chronic Water Quality Objectives
Silver	0.20	Chronic Water Quality Objectives
Zinc	17	Chronic Water Quality Objectives
Organic Compounds		
bis(2-ethylhexyl phthalate)	3.11	Chronic Water Quality Objectives

7.4 Calculation of Maximum Allowable Industrial Loading

Maximum Allowable Industrial Loading (MAIL) is the estimated maximum loading of a pollutant that can be received at a POTW's headworks from all industrial users and other controlled sources without causing pass through or interference. The MAIL was calculated by applying a 10% safety/growth factor to the MAHL and discounting for uncontrolled sources.

The formula for calculating MAIL is included below:

<p>Maximum Allowable Industrial Loading</p> $\text{MAIL} = \text{MAHL}(1 - (\text{SF} / 100)) - L_{\text{unc}}$ <p>MAIL = Maximum allowable industrial loading, lb/day MAHL = Maximum allowable headworks loading, lb/day SF = Safety factor, percent L_{unc} = Loading from uncontrolled sources (domestic)</p>
--

The table below contains the calculated MAILs for the POCs:

Pollutant of Concern	Maximum Allowable Headworks Loading (lb/day)	Criteria	Maximum Allowable Industrial Loading (lb/day)
Conventional			
Oil and Grease	585	NPDES Monthly Limit	-512
Turbidity (NTU)	15836	NPDES Monthly Limit	11167
Settleable Solids (mL/L)	2740	NPDES Monthly Limit	5450
Ammonia Nitrogen total (as N)	454	Chronic Water Quality Objectives	41
Priority Pollutants Metals, sulfur compounds & Cyanide			
Arsenic	1.98	Chronic Water Quality Objectives	1.27
Cadmium	0.68	Chronic Water Quality Objectives	0.52
Total Chromium	0.72	Chronic Water Quality Objectives	-0.38
Copper	0.49	Chronic Water Quality Objectives	-0.63
Molybdenum	134	40 CFR 503 Biosolids	120
Nickel	1.78	Chronic Water Quality Objectives	0.94
Silver	0.20	Chronic Water Quality Objectives	-0.65
Zinc	17	Chronic Water Quality Objectives	7.17
Organic Compounds			
bis(2-ethylhexyl phthalate)	3.11	Chronic Water Quality Objectives	2.73

Yellow highlighted rows indicate pollutants with negative MAILs. This occurs when the domestic / commercial loading exceeds the MAHL and safety factor creating a deficit in the MAIL.

8.0 DESIGNATING AND IMPLEMENTING LOCAL LIMITS

EPA recommends that local limits are needed when average influent loading of a toxic pollutant exceeds 60 percent of the MAHL.

8.1 Actual Loadings vs. MAHL

The formula below is used for calculating the percentage of MAHL being received at the POTW:

Actual Loading vs. MAHL Calculation
 $L_{\%} = (L_{INFL}/MAHL) 100$

$L_{\%}$ = Percentage of the MAHL
 L_{INFL} = Current average influent Loading, lb/day
 MAHL = Calculated MAHL lb/dy

The above equation has been used to calculate current loading as a percent of MAHL as shown in the table below:

Pollutant of Concern	Maximum Allowable Headworks Loading (lb/day)	Current Loading (lb/day)	Loading as a Percent of MAHL
Conventional			
Oil and Grease	585	1078	184%
Turbidity (NTU)	15836	3194	20%
Settleable Solids (mL/L)	2740	295	11%
Ammonia Nitrogen total (as N)	454	381	84%
Priority Pollutants Metals, sulfur compounds & Cyanide			
Arsenic	1.98	0.53	27%
Cadmium	0.68	0.094	14%
Total Chromium	0.72	1.067	148%
Copper	0.49	1.11	227%
Molybdenum	134	11.03	8%
Nickel	1.78	0.69	39%
Silver	0.20	0.87	427%
Zinc	17	8.5	50%
Organic Compounds			
bis(2-ethylhexyl phthalate)	3.11	0.069	2%

Yellow highlighted rows indicate pollutants with current loading greater than 60% of the MAHL.

EPA recommends that local limits are needed when the average influent loading of a toxic pollutant exceeds 60 percent of the MAHL (EPA, 2004).

The average actual loading of five pollutants exceed 60% of the MAHL, including oil and grease, ammonia nitrogen total, chromium total, copper, and silver.

There are existing local limits for oil and grease, ammonia nitrogen total, and copper. These limits were evaluated considering the new information contained in this study.

New local limits for total chromium and silver appears to be appropriate.

8.2 Ammonia Nitrogen Total

Crescent City has a local limit for ammonia nitrogen total set at 32 mg/l. The existing local limit was established in the 2012 Local Limits Study, (FES, 2012). The 2012 modeling indicated that loading at the time exceeded the MAHL and set the local limit at the average influent concentration for ammonia (32 mg/l).

The current study found that the average influent concentration of ammonia nitrogen total was 30 mg/l, and at 84% of the modeled maximum allowable headworks loading (MAHL).

It is recommended that City maintain the existing local limit of 32 mg/l.

8.3 Oil and Grease

Crescent City has a local limit for oil and grease set at 100 mg/l. According to the 2012 local limits study (FES, 2012);

“Zero discharge of Oil and Grease is not practical however, so the local limit for Oil and Grease must be based on what is achievable with reasonable controls. According to EPA’s Local Limits Development Guidance (EPA, 2004), an Oil and Grease limit of 100 mg/L is achievable with the application of best management practices or generally available pretreatment (e.g., grease interceptors).

The current study found that the average influent concentration of oil and grease was 72 mg/l, and at 184% of the modeled maximum allowable headworks loading (MAHL).

Since the current loading exceeds the modeled MAHL for oil and grease it is recommended that City maintain the existing local limit of 100 mg/l.

8.4 Chromium Total

Crescent City does not have a local limit for chromium total.

According to (FES, 2012) average influent concentration of total chromium was 0.002 mg/l, and at 7% of the modeled maximum allowable headworks loading (MAHL).

The current study found the average influent concentration of chromium total 0.089 mg/l, and at 148% of the modeled maximum allowable headworks loading (MAHL).

Since the current loading exceeds the modeled MAHL for chromium total it is recommended that City implement a new local limit of 0.10 mg/l (approximate average influent concentration plus 20%).

8.5 Copper

Crescent City has a local limit for copper set at 0.086 mg/l. According to (FES, 2012);

“the Maximum Allowable Headworks Loading methodology results in uniform concentrations (local limits) of zero for copper and ammonia. Limiting these pollutants to zero discharge is not practical because these pollutants are either a normal component of domestic wastewater, prevalent in the City’s water supply, or not achievable with reasonable controls. Adjustments to local limits for each of these pollutants was made setting the limit to the average influent concentration”

The current study found that the average influent concentration of copper was 0.087 mg/l, and at 227% of the modeled maximum allowable headworks loading (MAHL).

Since the current loading exceeds the modeled MAHL for copper it is recommended that City maintain the existing local limit of 0.086 mg/l.

8.6 Silver

Crescent City does not have a local limit for silver.

According to (FES, 2012) average influent concentration of silver was 0.00044 mg/l, and at 28.1% of the modeled maximum allowable headworks loading (MAHL).

The current study found the average influent concentration of silver total 0.070 mg/l, and at 427% of the modeled maximum allowable headworks loading (MAHL).

Since the current loading exceeds the modeled MAHL for silver total it is recommended that the City implement a new local limit of 0.084 mg/l (approximate average influent concentration plus 20%).

8.7 Proposed Local Limits

The City has decided to allocate MAILs uniformly among all IUs and place uniform concentration limits in the local SUO/resolution for four POCs. Changes to existing local limits and new local limits are proposed below:

Pollutant	Existing Local Limit in (mg/L) ppm
Ammonia	32.0
Copper	0.086
Lead	0.0037
Nickel	0.0044
Oil and Grease (total)	100
bis (2-ethylhexyl) phthalate	0.0096
Zinc	0.0033

Pollutant	Proposed New Limits in (mg/L) ppm
Ammonia	32.0
Copper	0.086
Lead	Eliminate Limit
Nickel	Eliminate Limit
Oil and Grease (total)	100
bis (2-ethylhexyl) phthalate	Eliminate Limit
Zinc	Eliminate Limit
Silver	0.084
Chromium	0.10

In EPA's view, a POTW should not use current loading as a percent of MAHL in deciding whether to continue to control a particular pollutant by a local limit because the enforcement of the local limit may be the reason that the pollutant loading has been reduced or is no longer causing problems. If the local limit were removed, industrial users (IUs) may discontinue their use of wastewater pretreatment and POTW loadings may increase above the threshold in the criteria (EPA, 2004).

There are only three SIUs with discharge permits being monitored. There are no IUs implementing pretreatment for the pollutants being proposed for local limit elimination and an increase in loading of Lead, Nickel, bis (2-ethylhexyl) phthalate, and zinc are not likely nor anticipated. These constituents are not used in the manufacture of beer or cheese.

The final list of proposed local limits is contained in the table below:

Pollutant	Proposed New Limits in (mg/L) ppm
Ammonia	32.0
Copper	0.086
Oil and Grease (total)	100
Silver	0.084
Chromium	0.10

The narrative limit for "***Petroleum oil, nonbiodegradable cutting oil, or products of mineral oil origin***" is proposed to be eliminated since it is covered by an existing numeric local limit.

9.0 REFERENCES

Freshwater Environmental Services, 2012, Crescent City Technical Basis for Wastewater Limits: January

United States Environmental Protection Agency, 2004, *Local Limits Development Guide*: July.

United States Environmental Protection Agency, 1975, *Treatability of Oil and Grease Discharged to Publicly Owned Treatment Works*: April.

Appendix A

LABORATORY RESULTS

Analyte	Sample Name	Sampe Date	Qualifer	Result	Units
Oil & Grease	CS #1-Comp-GRAB	05-Sep-19		32.6	mg/L
Oil & Grease	CS #1-Comp-GRAB	06-Sep-19		54.6	mg/L
Oil & Grease	CS #1-Comp-GRAB	07-Sep-19		93	mg/L
Oil & Grease	CS #1-Comp-GRAB	08-Sep-19		54.4	mg/L
Oil & Grease	CS #1-Comp-GRAB	09-Sep-19		92.2	mg/L
Oil & Grease	CS #1-Comp-GRAB	10-Sep-19		143	mg/L
Oil & Grease	CS #1-Comp-GRAB	11-Sep-19		52.9	mg/L
Oil & Grease	CS #2-Comp-GRAB	05-Sep-19		54.2	mg/L
Oil & Grease	CS #2-Comp-GRAB	06-Sep-19		54.2	mg/L
Oil & Grease	CS #2-Comp-GRAB	07-Sep-19		278	mg/L
Oil & Grease	CS #2-Comp-GRAB	08-Sep-19		109	mg/L
Oil & Grease	CS #2-Comp-GRAB	09-Sep-19		45.7	mg/L
Oil & Grease	CS #2-Comp-GRAB	10-Sep-19		125	mg/L
Oil & Grease	CS #2-Comp-GRAB	11-Sep-19		189	mg/L
Oil & Grease	Efff-Comp-GRAB	05-Sep-19		93.5	mg/L
Oil & Grease	Efff-Comp-GRAB	06-Sep-19	ND	0.9	mg/L
Oil & Grease	Efff-Comp-GRAB	07-Sep-19		21.3	mg/L
Oil & Grease	Efff-Comp-GRAB	08-Sep-19		26.1	mg/L
Oil & Grease	Efff-Comp-GRAB	09-Sep-19		30	mg/L
Oil & Grease	Efff-Comp-GRAB	10-Sep-19		36.4	mg/L
Oil & Grease	Efff-Comp-GRAB	11-Sep-19		27.8	mg/L
Oil & Grease	Inf Comp-GRAB	05-Sep-19		27.8	mg/L
Oil & Grease	Inf Comp-GRAB	06-Sep-19		88	mg/L
Oil & Grease	Inf Comp-GRAB	07-Sep-19		45.2	mg/L
Oil & Grease	Inf Comp-GRAB	08-Sep-19		170	mg/L
Oil & Grease	Inf Comp-GRAB	09-Sep-19	ND	0.9	mg/L
Oil & Grease	Inf Comp-GRAB	10-Sep-19		68	mg/L
Oil & Grease	Inf Comp-GRAB	11-Sep-19		104	mg/L

Turbidity	CS#1- Tractor Supply	05-Sep-19		160	NTU
Turbidity	CS#1- Tractor Supply	06-Sep-19		190	NTU
Turbidity	CS#1- Tractor Supply	07-Sep-19	NDA	0	NTU
Turbidity	CS#1- Tractor Supply	08-Sep-19		160	NTU
Turbidity	CS#1- Tractor Supply	09-Sep-19		150	NTU
Turbidity	CS#1- Tractor Supply	10-Sep-19		280	NTU
Turbidity	CS#1- Tractor Supply	11-Sep-19		170	NTU
Turbidity	CS#2 Perlitas	05-Sep-19		170	NTU
Turbidity	CS#2 Perlitas	06-Sep-19	NDA	0	NTU
Turbidity	CS#2 Perlitas	07-Sep-19		400	NTU
Turbidity	CS#2 Perlitas	08-Sep-19		650	NTU
Turbidity	CS#2 Perlitas	09-Sep-19		750	NTU
Turbidity	CS#2 Perlitas	10-Sep-19		550	NTU
Turbidity	CS#2 Perlitas	11-Sep-19		450	NTU
Turbidity	EFF-001: Effluent	05-Sep-19		8.7	NTU
Turbidity	EFF-001: Effluent	06-Sep-19		9.6	NTU
Turbidity	EFF-001: Effluent	07-Sep-19		9.2	NTU

Turbidity	EFF-001: Effluent	08-Sep-19		8.1	NTU
Turbidity	EFF-001: Effluent	09-Sep-19		9.4	NTU
Turbidity	EFF-001: Effluent	10-Sep-19		9.2	NTU
Turbidity	EFF-001: Effluent	11-Sep-19		8.6	NTU
Turbidity	INF-001: WWTP Influent	05-Sep-19		260	NTU
Turbidity	INF-001: WWTP Influent	06-Sep-19		120	NTU
Turbidity	INF-001: WWTP Influent	07-Sep-19		190	NTU
Turbidity	INF-001: WWTP Influent	08-Sep-19		140	NTU
Turbidity	INF-001: WWTP Influent	09-Sep-19		200	NTU
Turbidity	INF-001: WWTP Influent	10-Sep-19		140	NTU
Turbidity	INF-001: WWTP Influent	11-Sep-19		160	NTU

Settleable Solids	CS#1- Tractor Supply	05-Sep-19		24	mL / L
Settleable Solids	CS#1- Tractor Supply	06-Sep-19		37	mL / L
Settleable Solids	CS#1- Tractor Supply	07-Sep-19	NDA	0	mL / L
Settleable Solids	CS#1- Tractor Supply	08-Sep-19		15	mL / L
Settleable Solids	CS#1- Tractor Supply	09-Sep-19		15	mL / L
Settleable Solids	CS#1- Tractor Supply	10-Sep-19		45	mL / L
Settleable Solids	CS#1- Tractor Supply	11-Sep-19		19	mL / L
Settleable Solids	CS#2 Perlitas	05-Sep-19		30	mL / L
Settleable Solids	CS#2 Perlitas	06-Sep-19	NDA	0	mL / L
Settleable Solids	CS#2 Perlitas	07-Sep-19		34	mL / L
Settleable Solids	CS#2 Perlitas	08-Sep-19		31	mL / L
Settleable Solids	CS#2 Perlitas	09-Sep-19		60	mL / L
Settleable Solids	CS#2 Perlitas	10-Sep-19		31	mL / L
Settleable Solids	CS#2 Perlitas	11-Sep-19		35	mL / L
Settleable Solids	EFF-001: Effluent	05-Sep-19		0.1	mL / L
Settleable Solids	EFF-001: Effluent	06-Sep-19	ND	0.1	mL / L
Settleable Solids	EFF-001: Effluent	07-Sep-19		0.2	mL / L
Settleable Solids	EFF-001: Effluent	08-Sep-19	ND	0.1	mL / L
Settleable Solids	EFF-001: Effluent	09-Sep-19		0.2	mL / L
Settleable Solids	EFF-001: Effluent	10-Sep-19	ND	0.1	mL / L
Settleable Solids	EFF-001: Effluent	11-Sep-19	ND	0.1	mL / L
Settleable Solids	INF-001: WWTP Influent	05-Sep-19		29	mL / L
Settleable Solids	INF-001: WWTP Influent	06-Sep-19		35	mL / L
Settleable Solids	INF-001: WWTP Influent	07-Sep-19		34	mL / L
Settleable Solids	INF-001: WWTP Influent	08-Sep-19		28	mL / L
Settleable Solids	INF-001: WWTP Influent	09-Sep-19		32	mL / L
Settleable Solids	INF-001: WWTP Influent	10-Sep-19		34	mL / L
Settleable Solids	INF-001: WWTP Influent	11-Sep-19		34	mL / L

Ammonia- N	CS#1- Tractor Supply	05-Sep-19		43.5	mg/L NH3-N
Ammonia- N	CS#1- Tractor Supply	06-Sep-19		44	mg/L NH3-N
Ammonia- N	CS#1- Tractor Supply	07-Sep-19	NDA	0	mg/L NH3-N
Ammonia- N	CS#1- Tractor Supply	08-Sep-19		43.3	mg/L NH3-N
Ammonia- N	CS#1- Tractor Supply	09-Sep-19		42.5	mg/L NH3-N
Ammonia- N	CS#1- Tractor Supply	10-Sep-19		49.1	mg/L NH3-N

Ammonia- N	CS#1- Tractor Supply	11-Sep-19		42.4	mg/L NH3-N
Ammonia- N	CS#2 Perlitas	05-Sep-19		36.9	mg/L NH3-N
Ammonia- N	CS#2 Perlitas	06-Sep-19	NDA	0	mg/L NH3-N
Ammonia- N	CS#2 Perlitas	07-Sep-19		38.2	mg/L NH3-N
Ammonia- N	CS#2 Perlitas	08-Sep-19		38.2	mg/L NH3-N
Ammonia- N	CS#2 Perlitas	09-Sep-19		33.8	mg/L NH3-N
Ammonia- N	CS#2 Perlitas	10-Sep-19		40	mg/L NH3-N
Ammonia- N	CS#2 Perlitas	11-Sep-19		35.3	mg/L NH3-N
Ammonia- N	EFF-001: Effluent	05-Sep-19		15.2	mg/L NH3-N
Ammonia- N	EFF-001: Effluent	06-Sep-19		10.7	mg/L NH3-N
Ammonia- N	EFF-001: Effluent	07-Sep-19		11.2	mg/L NH3-N
Ammonia- N	EFF-001: Effluent	08-Sep-19		13.5	mg/L NH3-N
Ammonia- N	EFF-001: Effluent	09-Sep-19		12.3	mg/L NH3-N
Ammonia- N	EFF-001: Effluent	10-Sep-19		14.6	mg/L NH3-N
Ammonia- N	EFF-001: Effluent	11-Sep-19		11.5	mg/L NH3-N
Ammonia- N	INF-001: WWTP Influent	05-Sep-19		29	mg/L NH3-N
Ammonia- N	INF-001: WWTP Influent	06-Sep-19		30.6	mg/L NH3-N
Ammonia- N	INF-001: WWTP Influent	07-Sep-19		27.1	mg/L NH3-N
Ammonia- N	INF-001: WWTP Influent	08-Sep-19		30.9	mg/L NH3-N
Ammonia- N	INF-001: WWTP Influent	09-Sep-19		31.8	mg/L NH3-N
Ammonia- N	INF-001: WWTP Influent	10-Sep-19		27.4	mg/L NH3-N
Ammonia- N	INF-001: WWTP Influent	11-Sep-19		28.1	mg/L NH3-N

Arsenic	CS #1-Comp	05-Sep-19	ND	1.7	ug/L
Arsenic	CS #1-Comp	06-Sep-19		4.1	ug/L
Arsenic	CS #1-Comp	07-Sep-19	ND	1.7	ug/L
Arsenic	CS #1-Comp	08-Sep-19	ND	1.7	ug/L
Arsenic	CS #1-Comp	09-Sep-19		92.5	ug/L
Arsenic	CS #1-Comp	10-Sep-19		60.7	ug/L
Arsenic	CS #1-Comp	11-Sep-19		90.4	ug/L
Arsenic	CS #2-Comp	05-Sep-19	ND	1.7	ug/L
Arsenic	CS #2-Comp	07-Sep-19	ND	1.7	ug/L
Arsenic	CS #2-Comp	08-Sep-19		41.4	ug/L
Arsenic	CS #2-Comp	09-Sep-19		83.5	ug/L
Arsenic	CS #2-Comp	10-Sep-19		82.6	ug/L
Arsenic	CS #2-Comp	11-Sep-19		154	ug/L
Arsenic	Eff-Comp	05-Sep-19	ND	1.7	ug/L
Arsenic	Eff-Comp	06-Sep-19		38.7	ug/L
Arsenic	Eff-Comp	07-Sep-19	ND	1.7	ug/L
Arsenic	Eff-Comp	08-Sep-19		78.2	ug/L
Arsenic	Eff-Comp	09-Sep-19		62.3	ug/L
Arsenic	Eff-Comp	10-Sep-19		82.6	ug/L
Arsenic	Eff-Comp	11-Sep-19		77.9	ug/L
Arsenic	Inf-Comp	05-Sep-19	ND	1.7	ug/L
Arsenic	Inf-Comp	06-Sep-19		29.7	ug/L
Arsenic	Inf-Comp	07-Sep-19	ND	1.7	ug/L
Arsenic	Inf-Comp	08-Sep-19		39.1	ug/L

Arsenic	Inf-Comp	09-Sep-19		78.2 ug/L
Arsenic	Inf-Comp	10-Sep-19		92.5 ug/L
Arsenic	Inf-Comp	11-Sep-19		19.1 ug/L
Arsenic	Press Cake Comp-Grab	04-Sep-19	ND	0.47 mg/kg dry
Arsenic	Press Cake Comp-Grab	07-Sep-19	ND	0.5 mg/kg dry

Cadmium	CS #1-Comp	05-Sep-19	ND	0.08 ug/L
Cadmium	CS #1-Comp	06-Sep-19		3.83 ug/L
Cadmium	CS #1-Comp	07-Sep-19	ND	0.08 ug/L
Cadmium	CS #1-Comp	08-Sep-19	ND	0.08 ug/L
Cadmium	CS #1-Comp	09-Sep-19		18.3 ug/L
Cadmium	CS #1-Comp	10-Sep-19		12.3 ug/L
Cadmium	CS #1-Comp	11-Sep-19		14.2 ug/L
Cadmium	CS #2-Comp	05-Sep-19		0.34 ug/L
Cadmium	CS #2-Comp	07-Sep-19	ND	0.08 ug/L
Cadmium	CS #2-Comp	08-Sep-19		2.71 ug/L
Cadmium	CS #2-Comp	09-Sep-19		18.4 ug/L
Cadmium	CS #2-Comp	10-Sep-19		15.5 ug/L
Cadmium	CS #2-Comp	11-Sep-19		24.7 ug/L
Cadmium	Eff-Comp	05-Sep-19	ND	0.08 ug/L
Cadmium	Eff-Comp	06-Sep-19		10.3 ug/L
Cadmium	Eff-Comp	07-Sep-19	ND	0.08 ug/L
Cadmium	Eff-Comp	08-Sep-19		12.3 ug/L
Cadmium	Eff-Comp	09-Sep-19		12.6 ug/L
Cadmium	Eff-Comp	10-Sep-19		15.5 ug/L
Cadmium	Eff-Comp	11-Sep-19		11.3 ug/L
Cadmium	Inf-Comp	05-Sep-19	ND	0.08 ug/L
Cadmium	Inf-Comp	06-Sep-19		7.35 ug/L
Cadmium	Inf-Comp	07-Sep-19	ND	0.08 ug/L
Cadmium	Inf-Comp	08-Sep-19		6.15 ug/L
Cadmium	Inf-Comp	09-Sep-19		17.2 ug/L
Cadmium	Inf-Comp	10-Sep-19		18.3 ug/L
Cadmium	Inf-Comp	11-Sep-19		5.82 ug/L
Cadmium	Press Cake Comp-Grab	04-Sep-19		0.92 mg/kg dry
Cadmium	Press Cake Comp-Grab	07-Sep-19		0.62 mg/kg dry

Chromium	CS #1-Comp	05-Sep-19	ND	0.082 ug/L
Chromium	CS #1-Comp	06-Sep-19		46 ug/L
Chromium	CS #1-Comp	07-Sep-19		4.74 ug/L
Chromium	CS #1-Comp	08-Sep-19	ND	0.082 ug/L
Chromium	CS #1-Comp	09-Sep-19		189 ug/L
Chromium	CS #1-Comp	10-Sep-19		136 ug/L
Chromium	CS #1-Comp	11-Sep-19		172 ug/L
Chromium	CS #2-Comp	05-Sep-19		0.5 ug/L
Chromium	CS #2-Comp	07-Sep-19	ND	0.082 ug/L
Chromium	CS #2-Comp	08-Sep-19		48.3 ug/L
Chromium	CS #2-Comp	09-Sep-19		197 ug/L

Chromium	CS #2-Comp	10-Sep-19		172 ug/L
Chromium	CS #2-Comp	11-Sep-19		281 ug/L
Chromium	Eff-Comp	05-Sep-19	ND	0.082 ug/L
Chromium	Eff-Comp	06-Sep-19		106 ug/L
Chromium	Eff-Comp	07-Sep-19	ND	0.082 ug/L
Chromium	Eff-Comp	08-Sep-19		142 ug/L
Chromium	Eff-Comp	09-Sep-19		141 ug/L
Chromium	Eff-Comp	10-Sep-19		172 ug/L
Chromium	Eff-Comp	11-Sep-19		151 ug/L
Chromium	Inf-Comp	05-Sep-19	ND	0.082 ug/L
Chromium	Inf-Comp	06-Sep-19		77.9 ug/L
Chromium	Inf-Comp	07-Sep-19	ND	0.082 ug/L
Chromium	Inf-Comp	08-Sep-19		79 ug/L
Chromium	Inf-Comp	09-Sep-19		195 ug/L
Chromium	Inf-Comp	10-Sep-19		189 ug/L
Chromium	Inf-Comp	11-Sep-19		78.3 ug/L
Chromium	Press Cake Comp-Grab	04-Sep-19		32.3 mg/kg dry
Chromium	Press Cake Comp-Grab	07-Sep-19		29.7 mg/kg dry

Copper	CS #1-Comp	05-Sep-19		0.21 ug/L
Copper	CS #1-Comp	06-Sep-19		65.4 ug/L
Copper	CS #1-Comp	07-Sep-19		116 ug/L
Copper	CS #1-Comp	08-Sep-19	ND	0.05 ug/L
Copper	CS #1-Comp	09-Sep-19		162 ug/L
Copper	CS #1-Comp	10-Sep-19		131 ug/L
Copper	CS #1-Comp	11-Sep-19		128 ug/L
Copper	CS #2-Comp	05-Sep-19		48.1 ug/L
Copper	CS #2-Comp	07-Sep-19		49.9 ug/L
Copper	CS #2-Comp	08-Sep-19		41.9 ug/L
Copper	CS #2-Comp	09-Sep-19		153 ug/L
Copper	CS #2-Comp	10-Sep-19		181 ug/L
Copper	CS #2-Comp	11-Sep-19		228 ug/L
Copper	Eff-Comp	05-Sep-19	ND	0.05 ug/L
Copper	Eff-Comp	06-Sep-19		1080 ug/L
Copper	Eff-Comp	07-Sep-19		6.02 ug/L
Copper	Eff-Comp	08-Sep-19		88.4 ug/L
Copper	Eff-Comp	09-Sep-19		100 ug/L
Copper	Eff-Comp	10-Sep-19		181 ug/L
Copper	Eff-Comp	11-Sep-19		99.7 ug/L
Copper	Inf-Comp	05-Sep-19	ND	0.05 ug/L
Copper	Inf-Comp	06-Sep-19		88.1 ug/L
Copper	Inf-Comp	07-Sep-19	ND	0.05 ug/L
Copper	Inf-Comp	08-Sep-19		67.4 ug/L
Copper	Inf-Comp	09-Sep-19		229 ug/L
Copper	Inf-Comp	10-Sep-19		162 ug/L
Copper	Inf-Comp	11-Sep-19		67.7 ug/L
Copper	Press Cake Comp-Grab	04-Sep-19		288 mg/kg dry

Copper	Press Cake Comp-Grab	07-Sep-19		282 mg/kg dry
--------	----------------------	-----------	--	---------------

Cyanide, Total	CS #1-Comp-GRAB	05-Sep-19	J	0.003 mg/L
Cyanide, Total	CS #1-Comp-GRAB	06-Sep-19	J	0.003 mg/L
Cyanide, Total	CS #1-Comp-GRAB	07-Sep-19	J	0.003 mg/L
Cyanide, Total	CS #1-Comp-GRAB	08-Sep-19	J	0.003 mg/L
Cyanide, Total	CS #1-Comp-GRAB	09-Sep-19	ND	0.002 mg/L
Cyanide, Total	CS #1-Comp-GRAB	10-Sep-19	J	0.003 mg/L
Cyanide, Total	CS #1-Comp-GRAB	11-Sep-19	J	0.004 mg/L
Cyanide, Total	CS #2-Comp-GRAB	05-Sep-19	J	0.003 mg/L
Cyanide, Total	CS #2-Comp-GRAB	06-Sep-19	J	0.004 mg/L
Cyanide, Total	CS #2-Comp-GRAB	07-Sep-19	ND	0.002 mg/L
Cyanide, Total	CS #2-Comp-GRAB	08-Sep-19	J	0.003 mg/L
Cyanide, Total	CS #2-Comp-GRAB	09-Sep-19	J	0.003 mg/L
Cyanide, Total	CS #2-Comp-GRAB	10-Sep-19	J	0.003 mg/L
Cyanide, Total	CS #2-Comp-GRAB	11-Sep-19	J	0.004 mg/L
Cyanide, Total	Efff-Comp-GRAB	05-Sep-19	J	0.003 mg/L
Cyanide, Total	Efff-Comp-GRAB	06-Sep-19	J	0.003 mg/L
Cyanide, Total	Efff-Comp-GRAB	07-Sep-19	J	0.004 mg/L
Cyanide, Total	Efff-Comp-GRAB	08-Sep-19	J	0.003 mg/L
Cyanide, Total	Efff-Comp-GRAB	09-Sep-19	J	0.003 mg/L
Cyanide, Total	Efff-Comp-GRAB	10-Sep-19	J	0.003 mg/L
Cyanide, Total	Efff-Comp-GRAB	11-Sep-19	J	0.004 mg/L
Cyanide, Total	Inf-Comp-GRAB	05-Sep-19	J	0.003 mg/L
Cyanide, Total	Inf-Comp-GRAB	06-Sep-19	J	0.003 mg/L
Cyanide, Total	Inf-Comp-GRAB	07-Sep-19	J	0.003 mg/L
Cyanide, Total	Inf-Comp-GRAB	08-Sep-19	J	0.003 mg/L
Cyanide, Total	Inf-Comp-GRAB	09-Sep-19	J	0.004 mg/L
Cyanide, Total	Inf-Comp-GRAB	10-Sep-19	J	0.003 mg/L
Cyanide, Total	Inf-Comp-GRAB	11-Sep-19	J	0.004 mg/L
Cyanide, Total	Press Cake Comp-Grab	04-Sep-19		1.39 mg/kg dry
Cyanide, Total	Press Cake Comp-Grab	07-Sep-19		0.24 mg/kg dry

Lead	CS #1-Comp	05-Sep-19	ND	3E-04 mg/L
Lead	CS #1-Comp	06-Sep-19	ND	3E-04 mg/L
Lead	CS #1-Comp	07-Sep-19		0.018 mg/L
Lead	CS #1-Comp	08-Sep-19	ND	3E-04 mg/L
Lead	CS #1-Comp	09-Sep-19	ND	3E-04 mg/L
Lead	CS #1-Comp	10-Sep-19	ND	3E-04 mg/L
Lead	CS #1-Comp	11-Sep-19	ND	3E-04 mg/L
Lead	CS #2-Comp	05-Sep-19	ND	3E-04 mg/L
Lead	CS #2-Comp	07-Sep-19	ND	3E-04 mg/L
Lead	CS #2-Comp	08-Sep-19	ND	3E-04 mg/L
Lead	CS #2-Comp	09-Sep-19	ND	3E-04 mg/L
Lead	CS #2-Comp	10-Sep-19	ND	3E-04 mg/L
Lead	CS #2-Comp	11-Sep-19	ND	3E-04 mg/L
Lead	Eff-Comp	05-Sep-19	ND	3E-04 mg/L

Lead	Eff-Comp	06-Sep-19	ND	3E-04	mg/L
Lead	Eff-Comp	07-Sep-19	ND	3E-04	mg/L
Lead	Eff-Comp	08-Sep-19	ND	3E-04	mg/L
Lead	Eff-Comp	09-Sep-19	ND	3E-04	mg/L
Lead	Eff-Comp	10-Sep-19	ND	3E-04	mg/L
Lead	Eff-Comp	11-Sep-19	ND	3E-04	mg/L
Lead	Inf-Comp	05-Sep-19	ND	3E-04	mg/L
Lead	Inf-Comp	06-Sep-19	ND	3E-04	mg/L
Lead	Inf-Comp	07-Sep-19	ND	3E-04	mg/L
Lead	Inf-Comp	08-Sep-19	ND	3E-04	mg/L
Lead	Inf-Comp	09-Sep-19	ND	3E-04	mg/L
Lead	Inf-Comp	10-Sep-19	ND	3E-04	mg/L
Lead	Inf-Comp	11-Sep-19	ND	3E-04	mg/L
Lead	Press Cake Comp-Grab	04-Sep-19	ND	0.47	mg/kg dry
Lead	Press Cake Comp-Grab	07-Sep-19	ND	0.5	mg/kg dry

Molybdenum	CS #1-Comp	05-Sep-19		16.2	ug/L
Molybdenum	CS #1-Comp	06-Sep-19		24.8	ug/L
Molybdenum	CS #1-Comp	07-Sep-19	ND	0.4	ug/L
Molybdenum	CS #1-Comp	08-Sep-19	ND	0.4	ug/L
Molybdenum	CS #1-Comp	09-Sep-19		126	ug/L
Molybdenum	CS #1-Comp	10-Sep-19		90.5	ug/L
Molybdenum	CS #1-Comp	11-Sep-19		119	ug/L
Molybdenum	CS #2-Comp	05-Sep-19	ND	0.4	ug/L
Molybdenum	CS #2-Comp	07-Sep-19	ND	0.4	ug/L
Molybdenum	CS #2-Comp	08-Sep-19		40.9	ug/L
Molybdenum	CS #2-Comp	09-Sep-19		125	ug/L
Molybdenum	CS #2-Comp	10-Sep-19		112	ug/L
Molybdenum	CS #2-Comp	11-Sep-19		199	ug/L
Molybdenum	Eff-Comp	05-Sep-19	ND	0.4	ug/L
Molybdenum	Eff-Comp	06-Sep-19		59.3	ug/L
Molybdenum	Eff-Comp	07-Sep-19	ND	0.4	ug/L
Molybdenum	Eff-Comp	08-Sep-19		93.9	ug/L
Molybdenum	Eff-Comp	09-Sep-19		78.5	ug/L
Molybdenum	Eff-Comp	10-Sep-19		112	ug/L
Molybdenum	Eff-Comp	11-Sep-19		92.1	ug/L
Molybdenum	Inf-Comp	05-Sep-19	ND	0.4	ug/L
Molybdenum	Inf-Comp	06-Sep-19		36.8	ug/L
Molybdenum	Inf-Comp	07-Sep-19	ND	0.4	ug/L
Molybdenum	Inf-Comp	08-Sep-19		62	ug/L
Molybdenum	Inf-Comp	09-Sep-19		101	ug/L
Molybdenum	Inf-Comp	10-Sep-19		126	ug/L
Molybdenum	Inf-Comp	11-Sep-19		41.7	ug/L
Molybdenum	Press Cake Comp-Grab	04-Sep-19	ND	0.47	mg/kg dry
Molybdenum	Press Cake Comp-Grab	07-Sep-19	ND	0.5	mg/kg dry

Mercury	CS #1-Comp	05-Sep-19	ND	1E-04	ug/L
---------	------------	-----------	----	-------	------

Mercury	CS #1-Comp	06-Sep-19	ND	1E-04	ug/L
Mercury	CS #1-Comp	07-Sep-19	ND	1E-04	ug/L
Mercury	CS #1-Comp	08-Sep-19	ND	1E-04	ug/L
Mercury	CS #1-Comp	09-Sep-19	ND	1E-04	ug/L
Mercury	CS #1-Comp	10-Sep-19	ND	1E-04	ug/L
Mercury	CS #1-Comp	11-Sep-19	ND	1E-04	ug/L
Mercury	CS #2-Comp	05-Sep-19	ND	1E-04	ug/L
Mercury	CS #2-Comp	07-Sep-19	ND	1E-04	ug/L
Mercury	CS #2-Comp	08-Sep-19	ND	1E-04	ug/L
Mercury	CS #2-Comp	09-Sep-19	ND	1E-04	ug/L
Mercury	CS #2-Comp	10-Sep-19	ND	1E-04	ug/L
Mercury	CS #2-Comp	11-Sep-19	ND	1E-04	ug/L
Mercury	Eff-Comp	05-Sep-19	ND	1E-04	ug/L
Mercury	Eff-Comp	06-Sep-19	ND	1E-04	ug/L
Mercury	Eff-Comp	07-Sep-19	ND	1E-04	ug/L
Mercury	Eff-Comp	08-Sep-19	ND	1E-04	ug/L
Mercury	Eff-Comp	09-Sep-19	ND	1E-04	ug/L
Mercury	Eff-Comp	10-Sep-19	ND	1E-04	ug/L
Mercury	Eff-Comp	11-Sep-19	ND	1E-04	ug/L
Mercury	Inf-Comp	05-Sep-19	ND	1E-04	ug/L
Mercury	Inf-Comp	06-Sep-19	ND	1E-04	ug/L
Mercury	Inf-Comp	07-Sep-19	ND	1E-04	ug/L
Mercury	Inf-Comp	08-Sep-19	ND	1E-04	ug/L
Mercury	Inf-Comp	09-Sep-19	ND	1E-04	ug/L
Mercury	Inf-Comp	10-Sep-19	ND	1E-04	ug/L
Mercury	Inf-Comp	11-Sep-19		0.977	ug/L
Mercury	Press Cake Comp-Grab	04-Sep-19	ND	0.2	mg/kg dry
Mercury	Press Cake Comp-Grab	07-Sep-19	ND	0.2	mg/kg dry

Nickel	CS #1-Comp	05-Sep-19	ND	0.6	ug/L
Nickel	CS #1-Comp	06-Sep-19		29.7	ug/L
Nickel	CS #1-Comp	07-Sep-19		14	ug/L
Nickel	CS #1-Comp	08-Sep-19	ND	0.6	ug/L
Nickel	CS #1-Comp	09-Sep-19		128	ug/L
Nickel	CS #1-Comp	10-Sep-19		95.8	ug/L
Nickel	CS #1-Comp	11-Sep-19		94.6	ug/L
Nickel	CS #2-Comp	05-Sep-19		4.47	ug/L
Nickel	CS #2-Comp	07-Sep-19	ND	0.6	ug/L
Nickel	CS #2-Comp	08-Sep-19		26.8	ug/L
Nickel	CS #2-Comp	09-Sep-19		125	ug/L
Nickel	CS #2-Comp	10-Sep-19		116	ug/L
Nickel	CS #2-Comp	11-Sep-19		169	ug/L
Nickel	Eff-Comp	05-Sep-19	ND	0.6	ug/L
Nickel	Eff-Comp	06-Sep-19		68.9	ug/L
Nickel	Eff-Comp	07-Sep-19	ND	0.6	ug/L
Nickel	Eff-Comp	08-Sep-19		78	ug/L
Nickel	Eff-Comp	09-Sep-19		93.1	ug/L

Nickel	Eff-Comp	10-Sep-19		116 ug/L
Nickel	Eff-Comp	11-Sep-19		85.8 ug/L
Nickel	Inf-Comp	05-Sep-19	ND	0.6 ug/L
Nickel	Inf-Comp	06-Sep-19		48.2 ug/L
Nickel	Inf-Comp	07-Sep-19	ND	0.6 ug/L
Nickel	Inf-Comp	08-Sep-19		47.8 ug/L
Nickel	Inf-Comp	09-Sep-19		112 ug/L
Nickel	Inf-Comp	10-Sep-19		128 ug/L
Nickel	Inf-Comp	11-Sep-19		41.4 ug/L
Nickel	Press Cake Comp-Grab	04-Sep-19		22.8 mg/kg dry
Nickel	Press Cake Comp-Grab	07-Sep-19		22.6 mg/kg dry

Sulfate	CS #1-Comp	05-Sep-19		14 mg/L
Sulfate	CS #1-Comp	06-Sep-19		16.2 mg/L
Sulfate	CS #1-Comp	07-Sep-19		17.2 mg/L
Sulfate	CS #1-Comp	08-Sep-19		15.4 mg/L
Sulfate	CS #1-Comp	09-Sep-19		13.9 mg/L
Sulfate	CS #1-Comp	10-Sep-19		14 mg/L
Sulfate	CS #1-Comp	11-Sep-19		10.7 mg/L
Sulfate	CS #2-Comp	05-Sep-19		29.2 mg/L
Sulfate	CS #2-Comp	07-Sep-19		22.5 mg/L
Sulfate	CS #2-Comp	08-Sep-19		0.69 mg/L
Sulfate	CS #2-Comp	09-Sep-19		21.5 mg/L
Sulfate	CS #2-Comp	10-Sep-19		25.4 mg/L
Sulfate	CS #2-Comp	11-Sep-19		33.8 mg/L
Sulfate	Eff-Comp	05-Sep-19		31.3 mg/L
Sulfate	Eff-Comp	06-Sep-19		31.8 mg/L
Sulfate	Eff-Comp	07-Sep-19		30.7 mg/L
Sulfate	Eff-Comp	08-Sep-19		33.1 mg/L
Sulfate	Eff-Comp	09-Sep-19		30.5 mg/L
Sulfate	Eff-Comp	10-Sep-19		27.4 mg/L
Sulfate	Eff-Comp	11-Sep-19		29.3 mg/L
Sulfate	Inf-Comp	05-Sep-19		14.2 mg/L
Sulfate	Inf-Comp	06-Sep-19		15.4 mg/L
Sulfate	Inf-Comp	07-Sep-19		15.6 mg/L
Sulfate	Inf-Comp	08-Sep-19		0.49 mg/L
Sulfate	Inf-Comp	09-Sep-19		16.3 mg/L
Sulfate	Inf-Comp	10-Sep-19		16.5 mg/L
Sulfate	Inf-Comp	11-Sep-19		15.9 mg/L
Sulfide	CS #1-Comp-GRAB	05-Sep-19		0.75 mg/L
Sulfide	CS #1-Comp-GRAB	06-Sep-19		0.38 mg/L
Sulfide	CS #1-Comp-GRAB	07-Sep-19		0.52 mg/L
Sulfide	CS #1-Comp-GRAB	08-Sep-19		0.5 mg/L
Sulfide	CS #1-Comp-GRAB	09-Sep-19		0.39 mg/L
Sulfide	CS #1-Comp-GRAB	10-Sep-19		0.48 mg/L
Sulfide	CS #1-Comp-GRAB	11-Sep-19		0.42 mg/L
Sulfide	CS #2-Comp-GRAB	05-Sep-19		0.8 mg/L

Sulfide	CS #2-Comp-GRAB	06-Sep-19		0.8 mg/L
Sulfide	CS #2-Comp-GRAB	07-Sep-19		0.8 mg/L
Sulfide	CS #2-Comp-GRAB	08-Sep-19		1.25 mg/L
Sulfide	CS #2-Comp-GRAB	09-Sep-19		0.74 mg/L
Sulfide	CS #2-Comp-GRAB	10-Sep-19		0.39 mg/L
Sulfide	CS #2-Comp-GRAB	11-Sep-19		0.56 mg/L
Sulfide	Efff-Comp-GRAB	05-Sep-19	J	0.02 mg/L
Sulfide	Efff-Comp-GRAB	06-Sep-19	ND	0.01 mg/L
Sulfide	Efff-Comp-GRAB	07-Sep-19	ND	0.01 mg/L
Sulfide	Efff-Comp-GRAB	08-Sep-19	J	0.02 mg/L
Sulfide	Efff-Comp-GRAB	09-Sep-19	J	0.02 mg/L
Sulfide	Efff-Comp-GRAB	10-Sep-19	J	0.02 mg/L
Sulfide	Efff-Comp-GRAB	11-Sep-19	J	0.02 mg/L
Sulfide	Inf Comp-GRAB	05-Sep-19		0.55 mg/L
Sulfide	Inf Comp-GRAB	06-Sep-19		0.39 mg/L
Sulfide	Inf Comp-GRAB	07-Sep-19		0.29 mg/L
Sulfide	Inf Comp-GRAB	08-Sep-19		0.37 mg/L
Sulfide	Inf Comp-GRAB	09-Sep-19		0.35 mg/L
Sulfide	Inf Comp-GRAB	10-Sep-19		0.3 mg/L
Sulfide	Inf Comp-GRAB	11-Sep-19		0.28 mg/L

Selenium	CS #1-Comp	08-Sep-19	ND	0.12 ug/L
Selenium	CS #1-Comp	11-Sep-19	ND	0.12 ug/L
Selenium	CS #1-Comp	10-Sep-19	ND	0.12 ug/L
Selenium	CS #1-Comp	05-Sep-19	ND	0.12 ug/L
Selenium	CS #1-Comp	07-Sep-19	ND	0.12 ug/L
Selenium	CS #1-Comp	09-Sep-19	ND	0.12 ug/L
Selenium	CS #1-Comp	06-Sep-19	ND	0.12 ug/L
Selenium	CS #2-Comp	11-Sep-19	ND	0.12 ug/L
Selenium	CS #2-Comp	09-Sep-19	ND	0.12 ug/L
Selenium	CS #2-Comp	10-Sep-19	ND	0.12 ug/L
Selenium	CS #2-Comp	07-Sep-19	ND	0.12 ug/L
Selenium	CS #2-Comp	08-Sep-19	ND	0.12 ug/L
Selenium	CS #2-Comp	05-Sep-19	ND	0.12 ug/L
Selenium	Eff-Comp	06-Sep-19	ND	0.12 ug/L
Selenium	Eff-Comp	05-Sep-19	ND	0.12 ug/L
Selenium	Eff-Comp	07-Sep-19	ND	0.12 ug/L
Selenium	Eff-Comp	10-Sep-19	ND	0.12 ug/L
Selenium	Eff-Comp	09-Sep-19	ND	0.12 ug/L
Selenium	Eff-Comp	08-Sep-19	ND	0.12 ug/L
Selenium	Eff-Comp	11-Sep-19	ND	0.12 ug/L
Selenium	Inf-Comp	05-Sep-19	ND	0.12 ug/L
Selenium	Inf-Comp	09-Sep-19	ND	0.12 ug/L
Selenium	Inf-Comp	06-Sep-19	ND	0.12 ug/L
Selenium	Inf-Comp	07-Sep-19	ND	0.12 ug/L
Selenium	Inf-Comp	08-Sep-19	ND	0.12 ug/L
Selenium	Inf-Comp	11-Sep-19	ND	0.12 ug/L

Selenium	Inf-Comp	10-Sep-19	ND	0.12	ug/L
Selenium	Press Cake Comp-Grab	04-Sep-19	ND	0.47	mg/kg dry
Selenium	Press Cake Comp-Grab	07-Sep-19	ND	0.5	mg/kg dry

Silver	CS #1-Comp	08-Sep-19	ND	0.095	ug/L
Silver	CS #1-Comp	11-Sep-19		136	ug/L
Silver	CS #1-Comp	10-Sep-19		116	ug/L
Silver	CS #1-Comp	05-Sep-19	ND	0.095	ug/L
Silver	CS #1-Comp	07-Sep-19	ND	0.095	ug/L
Silver	CS #1-Comp	09-Sep-19		163	ug/L
Silver	CS #1-Comp	06-Sep-19		42	ug/L
Silver	CS #2-Comp	11-Sep-19		219	ug/L
Silver	CS #2-Comp	09-Sep-19		169	ug/L
Silver	CS #2-Comp	10-Sep-19		139	ug/L
Silver	CS #2-Comp	07-Sep-19	ND	0.095	ug/L
Silver	CS #2-Comp	08-Sep-19		30.2	ug/L
Silver	CS #2-Comp	05-Sep-19	ND	0.095	ug/L
Silver	Eff-Comp	06-Sep-19		62.9	ug/L
Silver	Eff-Comp	05-Sep-19	ND	0.095	ug/L
Silver	Eff-Comp	07-Sep-19	ND	0.095	ug/L
Silver	Eff-Comp	10-Sep-19		139	ug/L
Silver	Eff-Comp	09-Sep-19		124	ug/L
Silver	Eff-Comp	08-Sep-19		105	ug/L
Silver	Eff-Comp	11-Sep-19		120	ug/L
Silver	Inf-Comp	05-Sep-19	ND	0.095	ug/L
Silver	Inf-Comp	09-Sep-19		144	ug/L
Silver	Inf-Comp	06-Sep-19		67.8	ug/L
Silver	Inf-Comp	07-Sep-19	ND	0.095	ug/L
Silver	Inf-Comp	08-Sep-19		52.1	ug/L
Silver	Inf-Comp	11-Sep-19		64.2	ug/L
Silver	Inf-Comp	10-Sep-19		163	ug/L
Silver	Press Cake Comp-Grab	04-Sep-19	ND	0.24	mg/kg dry
Silver	Press Cake Comp-Grab	07-Sep-19	ND	0.25	mg/kg dry

Zinc	CS #1-Comp	05-Sep-19		8440	ug/L
Zinc	CS #1-Comp	06-Sep-19		131	ug/L
Zinc	CS #1-Comp	07-Sep-19		507	ug/L
Zinc	CS #1-Comp	08-Sep-19		87.9	ug/L
Zinc	CS #1-Comp	09-Sep-19		131	ug/L
Zinc	CS #1-Comp	10-Sep-19		168	ug/L
Zinc	CS #1-Comp	11-Sep-19		98.5	ug/L
Zinc	CS #2-Comp	05-Sep-19		196	ug/L
Zinc	CS #2-Comp	07-Sep-19		172	ug/L
Zinc	CS #2-Comp	08-Sep-19		43.3	ug/L
Zinc	CS #2-Comp	09-Sep-19		108	ug/L
Zinc	CS #2-Comp	10-Sep-19		311	ug/L
Zinc	CS #2-Comp	11-Sep-19		299	ug/L

Zinc	Eff-Comp	05-Sep-19		25.9 ug/L
Zinc	Eff-Comp	06-Sep-19		64.4 ug/L
Zinc	Eff-Comp	07-Sep-19		56.9 ug/L
Zinc	Eff-Comp	08-Sep-19		69.8 ug/L
Zinc	Eff-Comp	09-Sep-19		63.5 ug/L
Zinc	Eff-Comp	10-Sep-19		311 ug/L
Zinc	Eff-Comp	11-Sep-19		52.9 ug/L
Zinc	Inf-Comp	05-Sep-19		276 ug/L
Zinc	Inf-Comp	06-Sep-19		346 ug/L
Zinc	Inf-Comp	07-Sep-19		279 ug/L
Zinc	Inf-Comp	08-Sep-19		170 ug/L
Zinc	Inf-Comp	09-Sep-19		124 ug/L
Zinc	Inf-Comp	10-Sep-19		131 ug/L
Zinc	Inf-Comp	11-Sep-19		396 ug/L
Zinc	Press Cake Comp-Grab	04-Sep-19		828 mg/kg dry
Zinc	Press Cake Comp-Grab	07-Sep-19		813 mg/kg dry

Bis (2-ethylhexy) Phthalate	CS #1-Comp	05-Sep-19		7.7 ug/L
Bis (2-ethylhexy) Phthalate	CS #1-Comp	06-Sep-19		9.6 ug/L
Bis (2-ethylhexy) Phthalate	CS #1-Comp	08-Sep-19		15.6 ug/L
Bis (2-ethylhexy) Phthalate	CS #1-Comp	09-Sep-19	J	3.3 ug/L
Bis (2-ethylhexy) Phthalate	CS #1-Comp	10-Sep-19	J	1.1 ug/L
Bis (2-ethylhexy) Phthalate	CS #1-Comp	11-Sep-19		6.8 ug/L
Bis (2-ethylhexy) Phthalate	CS #2-Comp	05-Sep-19	J	1.2 ug/L
Bis (2-ethylhexy) Phthalate	CS #2-Comp	07-Sep-19	J	3.1 ug/L
Bis (2-ethylhexy) Phthalate	CS #2-Comp	08-Sep-19	ND	0.7 ug/L
Bis (2-ethylhexy) Phthalate	CS #2-Comp	09-Sep-19	J	4.7 ug/L
Bis (2-ethylhexy) Phthalate	CS #2-Comp	10-Sep-19		15.1 ug/L
Bis (2-ethylhexy) Phthalate	CS #2-Comp	11-Sep-19		6.4 ug/L
Bis (2-ethylhexy) Phthalate	Eff-Comp	05-Sep-19	J	1.2 ug/L
Bis (2-ethylhexy) Phthalate	Eff-Comp	06-Sep-19		5.4 ug/L
Bis (2-ethylhexy) Phthalate	Eff-Comp	07-Sep-19	J	0.8 ug/L
Bis (2-ethylhexy) Phthalate	Eff-Comp	08-Sep-19	J	1.8 ug/L
Bis (2-ethylhexy) Phthalate	Eff-Comp	09-Sep-19	ND	0.7 ug/L
Bis (2-ethylhexy) Phthalate	Eff-Comp	10-Sep-19	ND	0.8 ug/L
Bis (2-ethylhexy) Phthalate	Eff-Comp	11-Sep-19		7.7 ug/L
Bis (2-ethylhexy) Phthalate	Inf-Comp	05-Sep-19		11.4 ug/L
Bis (2-ethylhexy) Phthalate	Inf-Comp	06-Sep-19	ND	0.8 ug/L
Bis (2-ethylhexy) Phthalate	Inf-Comp	07-Sep-19		7 ug/L
Bis (2-ethylhexy) Phthalate	Inf-Comp	08-Sep-19	J	8.8 ug/L
Bis (2-ethylhexy) Phthalate	Inf-Comp	09-Sep-19		18 ug/L
Bis (2-ethylhexy) Phthalate	Inf-Comp	10-Sep-19	J	0.9 ug/L
Bis (2-ethylhexy) Phthalate	Inf-Comp	11-Sep-19	J	2.4 ug/L

Dieldrin	CS #1-Comp	05-Sep-19	ND	0.001 ug/L
Dieldrin	CS #1-Comp	06-Sep-19	ND	0.001 ug/L
Dieldrin	CS #1-Comp	08-Sep-19	ND	0.001 ug/L

Dieldrin	CS #1-Comp	09-Sep-19	ND	0.001	ug/L
Dieldrin	CS #1-Comp	10-Sep-19	ND	0.001	ug/L
Dieldrin	CS #1-Comp	11-Sep-19	ND	0.001	ug/L
Dieldrin	CS #2-Comp	05-Sep-19	ND	0.001	ug/L
Dieldrin	CS #2-Comp	07-Sep-19	ND	0.001	ug/L
Dieldrin	CS #2-Comp	08-Sep-19	ND	0.001	ug/L
Dieldrin	CS #2-Comp	09-Sep-19	ND	0.001	ug/L
Dieldrin	CS #2-Comp	10-Sep-19	ND	0.001	ug/L
Dieldrin	CS #2-Comp	11-Sep-19	ND	0.001	ug/L
Dieldrin	Eff-Comp	05-Sep-19	ND	0.001	ug/L
Dieldrin	Eff-Comp	06-Sep-19	ND	0.001	ug/L
Dieldrin	Eff-Comp	07-Sep-19	ND	0.001	ug/L
Dieldrin	Eff-Comp	08-Sep-19	ND	0.001	ug/L
Dieldrin	Eff-Comp	09-Sep-19	ND	0.001	ug/L
Dieldrin	Eff-Comp	10-Sep-19	ND	0.001	ug/L
Dieldrin	Eff-Comp	11-Sep-19	ND	0.001	ug/L
Dieldrin	Inf-Comp	05-Sep-19	ND	0.001	ug/L
Dieldrin	Inf-Comp	06-Sep-19	ND	0.001	ug/L
Dieldrin	Inf-Comp	07-Sep-19	ND	0.001	ug/L
Dieldrin	Inf-Comp	08-Sep-19	ND	0.001	ug/L
Dieldrin	Inf-Comp	09-Sep-19	ND	0.001	ug/L
Dieldrin	Inf-Comp	10-Sep-19	ND	0.001	ug/L
Dieldrin	Inf-Comp	11-Sep-19	ND	0.001	ug/L

Appendix B

EPA Region 5 MAHL Spreadsheet

Local Limits Determination Based on NPDES Daily Effluent Limits

ENVIRONMENTAL CRITERIA AND PROCESS DATA BASE							MAXIMUM LOADING		INDUSTRIAL		Safety
Pollutant	IU Pollut. Flow (MGD) (Qind)	POTW Flow (MGD) (Qpotw)	Removal Efficiency (%) (Rpotw)	NPDES Daily Limit (mg/l) (Ccrit)	Domestic and Conc. (mg/l) (Cdom)	Commercial Flow (MGD) (Qdom)	Allowable Headworks (lbs/day) (Lhw)	Domestic/Commercial (lbs/day) (Ldom)	Allowable Loading (lbs/day) (Lind)	Local Limit (mg/l) (Cind)	Factor (%) (SF)
Oil and Grease	0.048	1.3140	53.2	75	98.4	1.266	1755	1039	541	1350	10
Turbidity (NTU)	0.048	1.3140	94.8		291.4	1.266	-	3077	-	-	10
Settleable Solids (mL/L)	0.048	1.3140	99.6		26.9	1.266	-	284	-	-	10
Ammonia Nitrogen total (as N)	0.048	1.3140	56.6	72	34.8	1.266	1816	367	1267	3166	10
Arsenic	0.048	1.3140	15.52		0.0485	1.266	-	0.51208434	-	-	10
Cadmium	0.048	1.3140	51.48		0.0086	1.266	-	0.090802584	-	-	10
Chromium	0.048	1.3140	9.17		0.0974	1.266	-	1.028392056	-	-	10
						0	-	0	-	-	10
Copper	0.048	1.3140	28.17	0.3	0.1015	1.266	4.58	1.07168166	3.047579373	7.61285815	10
Cyanide	0.048	1.3140			0	1.266	-	0	-	-	10
						0	-	0	-	-	10
Lead	0.048	1.3140			0	1.266	-	0	-	-	10
Mercury	0.048	1.3140			0	1.266	-	0	-	-	10
Molybdenum	0.048	1.3140	16.69		0.0668	1.266	-	0.705303792	-	-	10
Nickel	0.048	1.3140	7.56	0.6	0.0628	1.266	7.11	0.663070032	5.7386288	14.3351039	10
Selenium	0.048	1.3140			0	1.266	-	0	-	-	10
Silver	0.048	1.3140	12		0.0791	1.266	-	0.835172604	-	-	10
Zinc	0.048	1.3140	63		0.777	1.266	-	8.20390788	-	-	10
bis(2-ethylhexyl phthalat	0.048	1.3140	63		0.00627	1.266	-	0.066201419	-	-	10
Dielden	0.048	1.3140			0	1.266	-	0	-	-	10

(Qind) Industrial User total plant discharge flow in Million Gallons per Day (MGD) that contains a particular pollutant.
(Qpotw) POTW's average influent flow in MGD.
(Rpotw) Removal efficiency across POTW as percent.
(Ccrit) NPDES daily maximum permit limit for a particular pollutant in mg/l.
(Qdom) Domestic/commercial background flow in MGD.
(Cdom) Domestic/commercial background concentration for a particular pollutant in mg/l.
(Lhw) Maximum allowable headworks pollutant loading to the POTW in pounds per day (lbs/day).
(Ldom) Domestic/commercial background loading to the POTW for a particular pollutant in pounds per day (lbs/day).
(Lind) Maximum allowable industrial loading to the POTW in pounds per day.
(Cind) Industrial allowable local limit for a given pollutant in mg/l.
(SF) Safety factor as a percent.
8.34 Unit conversion factor
Lhw = $8.34 * Ccrit * Qpotw$
1 - Rpotw

TABLE 2

Local Limits Determination Based on NPDES Monthly Effluent Limits

ENVIRONMENTAL CRITERIA AND PROCESS DATA BASE							MAXIMUM LOADING		INDUSTRIAL		Safety
Pollutant	IU Pollut. Flow (MGD) (Qind)	POTW Flow (MGD) (Qpotw)	Removal Efficiency (%) (Rpotw)	NPDES Monthly Limit or 6-month Limit (mg/l) (Ccrit)	Domestic and Conc. (mg/l) (Cdom)	Commercial Flow (MGD) (Qdom)	Allowable Headworks (lbs/day) (Lhw)	Domestic/Commercial (lbs/day) (Ldom)	Allowable Loading (lbs/day) (Lind)	Local Limit (mg/l) (Cind)	Factor (%) (SF)
Oil and Grease	0.048	1.3140	53.17	25	98.4	1.266	585	1039	-512	-1280	10
Turbidity (NTU)	0.048	1.3140	94.81	75	291.4	1.266	15836	3077	11176	27918	10
Settleable Solids (mL/L)	0.048	1.3140	99.6	1	26.9	1.266	2740	284	2182	5450	10
Ammonia Nitrogen total (as N)	0.048	1.3140	56.56	18	34.8	1.266	454	367	41	103	10
Arsenic	0.048	1.314	15.52		0.0485	1.266	-	0.51208434	-	-	10
Cadmium	0.048	1.314	51.48		0.0086	1.266	-	0.090802584	-	-	10
Chromium	0.048	1.314	9.17		0.0974	1.266	-	1.028392056	-	-	10
						0	-	0	-	-	10
Copper	0.048	1.314	28.17	0.032	0.1015	1.266	0.49	1.07168166	-0.632293816	-1.579471	10
Cyanide	0.048	1.314	0		0	1.266	-	0	-	-	10
						0	-	0	-	-	10
Lead	0.048	1.314	0		0	1.266	-	0	-	-	10
Mercury	0.048	1.314	0		0	1.266	-	0	-	-	10
Molybdenum	0.048	1.314	16.69		0.0668	1.266	-	0.705303792	-	-	10
Nickel	0.048	1.314	7.56	0.15	0.0628	1.266	1.778249675	0.663070032	0.937354676	2.34151348	10
Selenium	0.048	1.314	0		0	1.266	-	0	-	-	10
Silver	0.048	1.314	12		0.0791	1.266	-	0.835172604	-	-	10
Zinc	0.048	1.314	63		0.777	1.266	-	8.20390788	-	-	10
bis(2-ethylhexyl phthalat	0.048	1.314	63								
Dielden	0.048	1.314	0								

(Qind) Industrial User total plant discharge flow in Million Gallons per Day (MGD) that contains a particular pollutant.
(Qpotw) POTW's average influent flow in MGD.
(Rpotw) Removal efficiency across POTW as percent.
(Ccrit) NPDES monthly maximum permit limit for a particular pollutant in mg/l.
(Qdom) Domestic/commercial background flow in MGD.
(Cdom) Domestic/commercial background concentration for a particular pollutant in mg/l.
(Lhw) Maximum allowable headworks pollutant loading to the POTW in pounds per day (lbs/day).
(Ldom) Domestic/commercial background loading to the POTW for a particular pollutant in pounds per day (lbs/day).
(Lind) Maximum allowable industrial loading to the POTW in pounds per day.
(Cind) Industrial allowable local limit for a given pollutant in mg/l.
(SF) Safety factor as a percent.
8.34 Unit conversion factor
Lhw = $8.34 * Ccrit * Qpotw$
1 - Rpotw

Local Limits Determination Based on USEPA 503 Sludge Regulations

ENVIRONMENTAL CRITERIA AND PROCESS DATA BASE

MAXIMUM LOADING

INDUSTRIAL

Pollutant	IU Pollut. Flow (MGD) (Qind)	POTW Flow (MGD) (Qpotw)	Sludge Flow (MGD) (Qsldg)	Percent Solids (%) (PS)	Removal Efficiency (%) (Rpotw)	503 Sludge Criteria (mg/kg) (Cslcrit)	Domestic and Conc. (mg/l) (Cdom)	Commercial Flow (MGD) (Qdom)	Allowable Headworks (lbs/day) (Lhw)	Domestic/Commercial (lbs/day) (Ldom)	Allowable Loading (lbs/day) (Lind)	Local Limit (mg/l) (Cind)	Safety Factor (%) (SF)
Arsenic	0.048	1.314	0.223	16	15.52	75	0.0485	1.266	143.80	0.51	128.90838	322.01	10
Cadmium	0.048	1.314	0.223	16	51.48	85	0.0086	1.266	49.13	0.09	44.128694	110.23	10
Chromium	0.048	1.314	0.223	16	9.17		0.0974	1.266	-	1.03	-	-	10
Copper	0.048	1.314	0.223	16	28.17	4300	0.1015	1.266	4542.27	1.07	4086.9672	10209.25	10
Cyanide	0.048	1.314	0.223	16	0		0	1.266	-	0	-	-	10
Lead	0.048	1.314	0.223	16	0	840	0	1.266	#DIV/0!	0	#DIV/0!	#DIV/0!	10
Mercury	0.048	1.314	0.223	16	0	57	0	1.266	#DIV/0!	0	#DIV/0!	#DIV/0!	10
Molybdenum	0.048	1.314	0.223	16	16.69	75	0.0668	1.266	133.72	0.71	119.64255	298.87	10
Nickel	0.048	1.314	0.223	16	7.56	420	0.0628	1.266	1653.17	0.66	1487.1929	3715.01	10
Selenium	0.048	1.314	0.223	16	0	100	0	1.266	#DIV/0!	0	#DIV/0!	#DIV/0!	10
Silver	0.048	1.314	0.223	16	12		0.0791	1.266	-	0.84	-	-	10
Zinc	0.048	1.314	0.223	16	63	7500	0.777	1.266	3542.51	8.20	3180.0589	7943.792339	10

(Qind) Industrial User total plant discharge flow in Million Gallons per Day (MGD) that contains a particular pollutant.
(Qpotw) POTW's average influent flow in MGD.
(Qsldg) Sludge flow to disposal in MGD.
(PS) Percent solids of sludge to disposal.
(Rpotw) Removal efficiency across POTW as a percent.
(Cslcrit) 503 sludge criteria in mg/kg dry sludge.
(Qdom) Domestic/commercial background flow in MGD.
(Cdom) Domestic/commercial background concentration for a particular pollutant in mg/l.
(Lhw) Maximum allowable headworks pollutant loading to the POTW in pounds per day (lbs/day).
(Ldom) Domestic/commercial background loading to the POTW for a particular pollutant in pounds per day (lbs/day).
(Lind) Maximum allowable industrial loading to the POTW in pounds per day.
(Cind) Industrial allowable local limit for a given pollutant in mg/l.
(SF) Safety factor as a percent.
8.34 Unit conversion factor
Lhw = $8.34 * Cslcrit * (PS/100) * Qsldg$

Local Limits Determination Based on Chronic Water Quality Standards
 ENVIRONMENTAL CRITERIA AND PROCESS DATA BASE

Pollutant	IU Pollut. Flow (MGD) (Qind)	POTW Flow (MGD) (Qpotw)	Upstream Flow (MGD) (Qstr)	Upstream Conc. (mg/l) (Cstr)	Removal Efficiency (%) (Rpotw)	Chronic WQS (mg/l) (Ccrit)	Domestic and Conc. (mg/l) (Cdom)	Commercial Flow (MGD) (Qdom)	MAXIMUM LOADING		INDUSTRIAL		Local Limit (mg/l) (Cind)	Safety Factor (%) (SF)
									Allowable Headworks (lbs/day) (Lhw)	Domestic/Commercial (lbs/day) (Ldom)	Allowable Loading (lbs/day) (Lind)	Local Limit (mg/l) (Cind)		
Ammonia Nitrogen total (as N)	0.048	1.314	38.106	0	56.56	0.6	34.8	1.266	454.09	367.43	41.25	103.04	10	
Arsenic	0.048	1.314	38.106	0.003	15.52	0.008	0.0485	1.266	1.98	0.5120843	1.2741624	3.18285973	10	
Cadmium	0.048	1.314	38.106	0	51.48	0.001	0.0086	1.266	0.68	0.0908026	0.5190212	1.29651589	10	
Chromium	0.048	1.314	38.106	0	9.17	0.002	0.0974	1.266	0.72	1.0283921	-0.3768749	-0.94143408	10	
Hex. Chrom.	0	0	0	0	0	0.002	0	0	0.00	0	0	#DIV/0!	10	
Copper	0.048	1.314	38.106	0.002	28.17	0.003	0.1015	1.266	0.49	1.0716817	-0.6322938	-1.57947096	10	
Cyanide	0.048	1.314	38.106	0	0	0	0	1.266	-	0	-	-	10	
Lead	0.048	1.314	38.106	0	0	0	0	1.266	-	0	-	-	10	
Mercury	0.048	1.314	38.106	0.0000005	0	0	0	1.266	-	0	-	-	10	
Molybdenum	0.048	1.314	38.106	0	16.69	0	0.0668	1.266	-	0.7053038	-	-	10	
Nickel	0.048	1.314	38.106	0	7.56	0.005	0.0628	1.266	1.78	0.66307	0.9373547	2.341513479	10	
Selenium	0.048	1.314	38.106	0	0	0	0	1.266	-	0	-	-	10	
Silver	0.048	1.314	38.106	0.00016	13	0.0007	0.0791	1.266	0.21	0.8351726	-0.649705	-1.62296422	10	
Zinc	0.048	1.314	38.106	0.0008	63	0.02	0.777	1.266	17.08	8.2039079	7.1715286	17.91448986	10	
bis(2-ethylhexl phthalat	0.048	1.314	38.106	0	63	0.0035	0.00627	1.266	3.11	0.0662014	2.7327251	6.826351723	10	
Dielden	0.048	1.314	38.106	0	0	0	0	1.266	-	0	-	-	10	
(Qind)	Industrial User total plant discharge flow in Million Gallons per Day (MGD) that contains a particular pollutant.													
(Qpotw)	POTW's average influent flow in MGD.													
(Qstr)	Receiving stream (upstream) 7Q10 flow in MGD.													
(Cstr)	Receiving stream background level in mg/l.													
(Rpotw)	Removal efficiency across POTW as percent.													
(Ccrit)	State chronic water quality standard for a particular pollutant in mg/l.													
(Qdom)	Domestic/commercial background flow in MGD.													
(Cdom)	Domestic/commercial background concentration for a particular pollutant in mg/l.													
(Lhw)	Maximum allowable headworks pollutant loading to the POTW in pounds per day (lbs/day).													
(Ldom)	Domestic/commercial background loading to the POTW for a particular pollutant in pounds per day (lbs/day).													
(Lind)	Maximum allowable industrial loading to the POTW in pounds per day.													
(Cind)	Industrial allowable local limit for a given pollutant in mg/l.													
(SF)	Safety factor as a percent.													
8.34	Unit conversion factor													
Lhw =	8.34 * (Ccrit * (Qstr + Qpotw) - (Cstr * Qstr))													
	1 - Rpotw													

TABLE 8

Local Limits Determination Based on Acute Water Quality Standards
 ENVIRONMENTAL CRITERIA AND PROCESS DATA BASE

Pollutant	IU Pollut. Flow (MGD) (Qind)	POTW Flow (MGD) (Qpotw)	Upstream Flow (MGD) (Qstr)	Upstream Conc. (mg/l) (Cstr)	Removal Efficiency (%) (Rpotw)	Acute WQS (mg/l) (Ccrit)	Domestic and Conc. (mg/l) (Cdom)	Commercial Flow (MGD) (Qdom)	MAXIMUM LOADING		INDUSTRIAL		Local Limit (mg/l) (Cind)	Safety Factor (%) (SF)
									Allowable Headworks (lbs/day) (Lhw)	Domestic/Commercial (lbs/day) (Ldom)	Allowable Loading (lbs/day) (Lind)	Local Limit (mg/l) (Cind)		
Arsenic	0.048	1.314	38.106	3	15.52	0.08	0.0485	1.266	-1097	0.5120843	-988.20146	-2468.52883	10	
Cadmium	0.048	1.314	38.106	0	51.48	0.01	0.0086	1.266	6.78	0.0908026	6.0074357	15.0065839	10	
Chromium	0.048	1.314	38.106	0	9.17	0.02	0.0974	1.266	7.24	1.0283921	5.4867796	13.70598417	10	
Hex. Chrom.	0	0	0	0	0	0	0	0	-	0	-	-	10	
Copper	0.048	1.314	38.106	0.002	28.17	0.03	0.1015	1.266	12.85	1.0716817	10.489711	26.20331478	10	
Cyanide	0.048	1.314	38.106	0	0	0	0	1.266	-	0	-	-	10	
Iron	0	0	0	0	0	0	0	0	-	0	-	-	10	
Lead	0.048	1.314	38.106	0	0	0	0	1.266	-	0	-	-	10	
Mercury	0.048	1.314	38.106	0.0000005	0	0	0	1.266	-	0	-	-	10	
Molybdenum	0.048	1.314	38.106	0	16.69	0	0.0668	1.266	-	0.7053038	-	-	10	
Nickel	0.048	1.314	38.106	0	7.56	0.05	0.0628	1.266	17.78	0.66307	15.341177	38.32228479	10	
Selenium	0.048	1.314	38.106	0	0	0	0	1.266	-	0	-	-	10	
Silver	0.048	1.314	38.106	0.00016	12	0.007	0.0791	1.266	2.56	0.8351726	1.4664659	3.663234091	10	
Zinc	0.048	1.314	38.106	0.0008	63	0.2	0.777	1.266	177.0	8.2039079	151.11632	377.4888142	10	
bis(2-ethylhexl phthalat	0.048	1.314	38.106	0	7.56	0.0628	0.0628	1.266	-	0.66307	-	-	10	
Dielden	0.048	1.314	38.106	0	0	0	0	1.266	-	0	-	-	10	
(Qind)	Industrial User total plant discharge flow in Million Gallons per Day (MGD) that contains a particular pollutant.													
(Qpotw)	POTW's average influent flow in MGD.													
(Qstr)	Receiving stream (upstream) 1Q10 flow in MGD.													
(Cstr)	Receiving stream background level in mg/l.													
(Rpotw)	Removal efficiency across POTW as percent.													
(Ccrit)	State acute water quality standard for a particular pollutant in mg/l.													
(Qdom)	Domestic/commercial background flow in MGD.													
(Cdom)	Domestic/commercial background concentration for a particular pollutant in mg/l.													
(Lhw)	Maximum allowable headworks pollutant loading to the POTW in pounds per day (lbs/day).													
(Ldom)	Domestic/commercial background loading to the POTW for a particular pollutant in pounds per day (lbs/day).													
(Lind)	Maximum allowable industrial loading to the POTW in pounds per day.													
(Cind)	Industrial allowable local limit for a given pollutant in mg/l.													
(SF)	Safety factor as a percent.													
8.34	Unit conversion factor													
Lhw =	8.34 * (Ccrit * (Qstr + Qpotw) - (Cstr * Qstr))													
	1 - Rpotw													

Appendix C

BIOSOLIDS COPPER TTLC AND STLC LABORATORY REPORTS



**NORTH COAST
LABORATORIES LTD.**

June 24, 2020

City of Crescent City
377 J Street
Crescent City, CA 95531

Attn: Regina Goodgame-Thill

Order No.: 2006096
Invoice No.: 153211
PO No.: 52826
ELAP No.1247-Expires July 2020

RE: WW

SAMPLE IDENTIFICATION

Fraction	Client Sample Description
01A	Press Cake Grab Composite
01B	Press Cake Grab Composite

ND = Not Detected at the Reporting Limit

Limit = Reporting Limit

Flag = Explanation in Case Narrative

All solid results are expressed on a wet-weight basis unless otherwise noted.

Approved for release by:

Roxanne Moore, Project Manager

Date: 24-Jun-2020

WorkOrder: 2006096

CASE NARRATIVE

Sample Press Cake Grab Composite was extracted following the method described in Title 22, CCR 66261.126, Appendix II (CAM WET).

Date: 24-Jun-2020

WorkOrder: 2006096

ANALYTICAL REPORT

Client Sample ID: Press Cake Grab Composite

Received: 6/4/2020

Lab ID: 2006096-01A

Collected: 5/22/2020 13:23

Test Name: EPA 6010B

Reference: EPA 6010B

<u>Parameter</u>	<u>Result</u>	<u>Flag</u>	<u>Limit</u>	<u>Units</u>	<u>DF</u>	<u>Extracted</u>	<u>Analyzed</u>
Copper	41		1.0	mg/kg	1.0	6/15/2020	6/16/2020

Client Sample ID: Press Cake Grab Composite

Received: 6/4/2020

Lab ID: 2006096-01B

Collected: 5/22/2020 13:23

Test Name: EPA 6010B

Reference: EPA 6010B

<u>Parameter</u>	<u>Result</u>	<u>Flag</u>	<u>Limit</u>	<u>Units</u>	<u>DF</u>	<u>Extracted</u>	<u>Analyzed</u>
Copper	ND		200	µg/L	20	6/15/2020	6/16/2020

North Coast Laboratories, Ltd.

Date: 6/24/2020

CLIENT: City of Crescent City
Work Order: 2006096
Project: WW

QC SUMMARY REPORT

Method Blank

Sample ID	Batch ID	Test Code	Units	Analysis Date	Prep Date						
MB-38720	38720	6ICPS	mg/kg	6/16/2020 3:58:47 PM	6/15/2020						
Client ID:		Run ID:	INICP2_200616B	SeqNo:	1476928						
Analyte	Result	Limit	SPK value	SPK Ref Val	% Rec	LowLimit	HighLimit	RPD Ref Val	%RPD	RPDLimit	Qual
Copper	ND	1.0									

Sample ID	Batch ID	Test Code	Units	Analysis Date	Prep Date						
MB-38723	38723	6ICPX	µg/L	6/16/2020 2:30:11 PM	6/15/2020						
Client ID:		Run ID:	INICP2_200616A	SeqNo:	1476914						
Analyte	Result	Limit	SPK value	SPK Ref Val	% Rec	LowLimit	HighLimit	RPD Ref Val	%RPD	RPDLimit	Qual
Copper	ND	200									

Qualifiers: ND - Not Detected at the Reporting Limit
 J - Analyte detected below quantitation limits

S - Spike Recovery outside accepted recovery limits
 R - RPD outside accepted recovery limits

B - Analyte detected in the associated Method Blank

North Coast Laboratories, Ltd.

Date: 6/24/2020

CLIENT: City of Crescent City
Work Order: 2006096
Project: WW

QC SUMMARY REPORT
 Sample Matrix Spike

Sample ID	Batch ID	Test Code	Units	Analysis Date	Prep Date						
2006096-01AMS	38720	6ICPS	mg/kg	6/16/2020 4:08:35 PM	6/15/2020						
Client ID: Press Cake Grab Composite		Run ID: INICP2_200616B		SeqNo: 1476932							
Analyte	Result	Limit	SPK value	SPK Ref Val	% Rec	LowLimit	HighLimit	RPD Ref Val	%RPD	RPDLimit	Qual
Copper	128.4	1.0	100	41.3	87.1%	75	125	0			
Sample ID	Batch ID	Test Code	Units	Analysis Date	Prep Date						
2006096-01AMSD	38720	6ICPS	mg/kg	6/16/2020 4:11:39 PM	6/15/2020						
Client ID: Press Cake Grab Composite		Run ID: INICP2_200616B		SeqNo: 1476933							
Analyte	Result	Limit	SPK value	SPK Ref Val	% Rec	LowLimit	HighLimit	RPD Ref Val	%RPD	RPDLimit	Qual
Copper	138.9	1.0	100	41.3	97.7%	75	125	128	7.92%	20	
Sample ID	Batch ID	Test Code	Units	Analysis Date	Prep Date						
2006096-01BMS	38723	6ICPX	µg/L	6/16/2020 2:49:26 PM	6/15/2020						
Client ID: Press Cake Grab Composite		Run ID: INICP2_200616A		SeqNo: 1476920							
Analyte	Result	Limit	SPK value	SPK Ref Val	% Rec	LowLimit	HighLimit	RPD Ref Val	%RPD	RPDLimit	Qual
Copper	1,854	200	2,000	19.6	91.7%	75	125	0			

Qualifiers: ND - Not Detected at the Reporting Limit
 J - Analyte detected below quantitation limits

S - Spike Recovery outside accepted recovery limits
 R - RPD outside accepted recovery limits

B - Analyte detected in the associated Method Blank

North Coast Laboratories, Ltd.

Date: 6/24/2020

CLIENT: City of Crescent City
Work Order: 2006096
Project: WW

QC SUMMARY REPORT
 Laboratory Control Spike

Sample ID	Batch ID	Test Code	Units	Analysis Date	Prep Date						
LCS-38720	38720	6ICPS	mg/kg	6/16/2020 4:00:49 PM	6/15/2020						
Client ID:		Run ID:	INICP2_200616B	SeqNo:	1476929						
Analyte	Result	Limit	SPK value	SPK Ref Val	% Rec	LowLimit	HighLimit	RPD Ref Val	%RPD	RPDLimit	Qual
Copper	99.56	1.0	100	0	99.6%	80	120	0			

Sample ID	Batch ID	Test Code	Units	Analysis Date	Prep Date						
LCSD-38720	38720	6ICPS	mg/kg	6/16/2020 4:03:15 PM	6/15/2020						
Client ID:		Run ID:	INICP2_200616B	SeqNo:	1476930						
Analyte	Result	Limit	SPK value	SPK Ref Val	% Rec	LowLimit	HighLimit	RPD Ref Val	%RPD	RPDLimit	Qual
Copper	99.52	1.0	100	0	99.5%	80	120	99.6	0.0452%	20	

Sample ID	Batch ID	Test Code	Units	Analysis Date	Prep Date						
LCS-38723	38723	6ICPX	µg/L	6/16/2020 2:34:04 PM	6/15/2020						
Client ID:		Run ID:	INICP2_200616A	SeqNo:	1476915						
Analyte	Result	Limit	SPK value	SPK Ref Val	% Rec	LowLimit	HighLimit	RPD Ref Val	%RPD	RPDLimit	Qual
Copper	1,905	200	2,000	0	95.3%	80	120	0			

Sample ID	Batch ID	Test Code	Units	Analysis Date	Prep Date						
LCSD-38723	38723	6ICPX	µg/L	6/16/2020 2:37:01 PM	6/15/2020						
Client ID:		Run ID:	INICP2_200616A	SeqNo:	1476916						
Analyte	Result	Limit	SPK value	SPK Ref Val	% Rec	LowLimit	HighLimit	RPD Ref Val	%RPD	RPDLimit	Qual
Copper	1,886	200	2,000	0	94.3%	80	120	1,900	1.02%	20	

Qualifiers: ND - Not Detected at the Reporting Limit
 J - Analyte detected below quantitation limits

S - Spike Recovery outside accepted recovery limits
 R - RPD outside accepted recovery limits

B - Analyte detected in the associated Method Blank

Appendix H:

Outfall Biological
Survey
Report
2020

CRESCENT CITY OCEAN OUTFALL BIOLOGICAL SURVEY REPORT

Order No. R1-2017-0002: Monitoring and Reporting Program

March 26, 2021

Prepared for: City of Crescent City
Wastewater Treatment Facility
210 Battery Street
Crescent City, CA 95531

Prepared by: Zack Larson & Associates
Environmental Consultants
P.O. Box 1400
Crescent City, CA 95531

Table of Contents

Introduction	3
Study Area.....	3
Methods.....	4
Results	7
Discussion	9
Conclusion.....	9
References	10
Appendix A: List of Primary Species Observed.....	11
Appendix B: Survey Dates and Tide Information	13

DRAFT



Introduction

The City of Crescent City (City) Wastewater Treatment Facility (WWTF) discharges treated municipal wastewater effluent into the Pacific Ocean (Figure 1). Effluent is discharged from the WWTF through a submerged 24-inch pipe that terminates in a rocky intertidal surge channel at Battery Point. The North Coast Regional Water Quality Control Board Order No. R1-2017-0002 requires the City to conduct a comparative evaluation of indigenous biota in the vicinity of the outfall at least once every 5 years.

California's rocky intertidal natural communities have been monitored since the late 1970s, beginning with the Channel Islands in southern California (Richards and Davis 1988). Rocky intertidal monitoring programs have been established elsewhere (Irvine 2010) and now a rocky shore monitoring program (Multi-Agency Rocky Intertidal Network) has been established and based on semiannual surveys of target species assemblages in fixed plots or transects (Engle 2008). We used a simple sampling approach modified from this program that may be replicated to show compliance with future Orders.

The Biological Survey has specific objectives: (1) Provide a photographic record of sessile invertebrates and marine algae using fixed plots (photoplots) as reference; (2) Estimate the relative abundance (percent cover) of flora and fauna within fixed plots and transects and compare between study and control sites; and (3) Identify any objectionable aquatic growths, floating particulates or grease and oil, aesthetically undesirable discoloration of the ocean surface, color of fish or shellfish, and any evidence of degradation of indigenous biota.

Study Area

The rocky shoreline of Del Norte County, California is part of the Franciscan Assemblage and composed of pillow basalt, shale and greywacke. Battery Point is a sea stack adjacent to Crescent City and accessible only during minus tides. A subterranean pipeline extends from the Crescent City WWTF to the outfall site (RSW-001) located on the south side of Battery Point, immediately adjacent to the Battery Point Lighthouse (latitude 41.743889N, longitude -124.202778W). The outfall faces the direction of prevailing waves and allows for frequent agitation and mixing of effluent into receiving waters. Concrete covers portions of the pipeline that extends from the WWTF to the ocean outfall, creating a flat bench in the high intertidal zone. Low intertidal and subtidal areas surrounding the outfall and concrete exhibit natural conditions.

The reference site (RSW-002) is located on the southwestern edge of Preston Island (latitude 41.75076N, longitude -124.21504W), approximately 0.9 miles (12.6 km) north from the outfall (RSW-001). The reference site includes rocky shore habitats and an orientation to prevailing waves similar to RSW-001 (Figure 1).



Figure 1. Aerial image of RSW-001 and RSW-002 study site locations.

Methods

A biological survey of intertidal flora and fauna was conducted at RSW-001 and RSW-002 from December 2018 to May 2020. Images of the sites and species encountered were collected and the species compositions and relative abundance were estimated for comparative analyses of RSW-001 and RSW-002. Methods used for monitoring marine algae and invertebrates were based on the approach developed by the Multi-Agency Rocky Intertidal Network (MARINE). However the methods were modified to fit the purpose and scale of this biological survey. The relative abundance of ecologically important organisms was estimated during low tide events using fixed plots and transects in targeted species assemblages. Observations of avian and marine mammals were noted at each location. Survey location information is in Table 1 and Figures 2 and 3.

Five 50cm x 75cm (0.375m²) photoplots were established at RSW-001 and used to survey target species assemblages (measured as percent cover). Five temporary 0.375m² plots were sited randomly at the control site (RSW-002). Plots were established at sites with sufficient cover of the target species, including California mussels (*Mytilus californianus*), barnacles (*Chthamalus dalli*, *Balanus glandula*, *Semibalanus cariosus*), and marine algae (e.g. *Endocladia muricata*, *Pelvetiopsis limitata*, *Fucus gardneri*). Plots were sampled as conditions allowed during spring and fall at sites RSW-001 and RSW-002.

Table 1. Summary of photoplots, plots and transects monitored at RSW-001 and RSW-002.

Site	Survey Type	Survey ID	Latitude (N)	Longitude (W)	Target Group or species	Complete?
RSW-001	Plot	RSW1P1	41.74375	124.20269	sessile plants/animals	Yes
RSW-001	Plot	RSW1P2	41.74368	124.20279	sessile plants/animals	Yes
RSW-001	Plot	RSW1P3	41.74371	124.20290	sessile plants/animals	Yes
RSW-001	Plot	RSW1P4	41.74368	124.20293	sessile plants/animals	Yes
RSW-001	Plot	RSW1P5	41.7437	124.20290	sessile plants/animals	Yes
RSW-001	Plot	RSW1Star	41.7437	124.20293	Sea Stars	Yes
RSW-001	Transect	RSW1T1	41.74378	124.20268	All	Yes
RSW-001	Transect	RSW1T2	41.74370	124.20290	All	Yes
RSW-002	Plot	RSW2P1	41.75076	124.21504	sessile plants/animals	Yes
RSW-002	Plot	RSW2P2	41.75076	124.21506	sessile plants/animals	No
RSW-002	Plot	RSW2P3	41.75063	124.21553	sessile plants/animals	Yes
RSW-002	Plot	RSW2P4	41.75113	124.21657	sessile plants/animals	Yes
RSW-002	Plot	RSW2P5	41.75125	124.21656	sessile plants/animals	Yes
RSW-002	Plot	RSW2Star	41.75087	124.21629	Sea Stars	Yes
RSW-002	Transect	RSW2T1	41.75087	124.21629	All	Yes
RSW-002	Transect	RSW2T2	41.75083	124.21626	All	Yes

The quadrupod apparatus, constructed of PVC pipe, was used to support the camera at a constant height and orientation to ensure consistent framing of each 50x75cm plot (Figure 4). The lens of the camera was aligned to provide coverage of the entire plot. The quadrupod was placed over each plot with plot numbers and time-stamps captured in the image. The point-intercept method was used with point contacts quantified by superimposing a uniform grid of 100 dots (and/or 50 dots x2) on the digital image. The digital image was manipulated (converted to 4000px by 3000px) to provide complete coverage of the plot imaged within the quadrupod frame. Layering was not scored separately resulting in 100% total cover.

Two 10 m transects were performed at RSW-001 and RSW-001. Transects were scored with respect to the occurrences of algae, animals, or substrates directly under 100 points (point intercept method) uniformly distributed at 10 cm intervals. Transects were then combined for each site and compared.

Sea star plots were adjacent to the RSW-001 Transect 2 (RSW1T2) and between RSW-002 Plots 3 and 4 ("RSW2P3" and "RSW2P4") (Figures 2&3). The sea star plots were established in the field where sea stars were present, but plots were not intended to quantify the overall density of sea stars at each site. Each ochre sea star encountered was counted, measured (arm) and color (purple/orange) was noted. Other rarer sea stars were counted when encountered. General observations of water visibility and the presence of birds and marine mammals were noted.

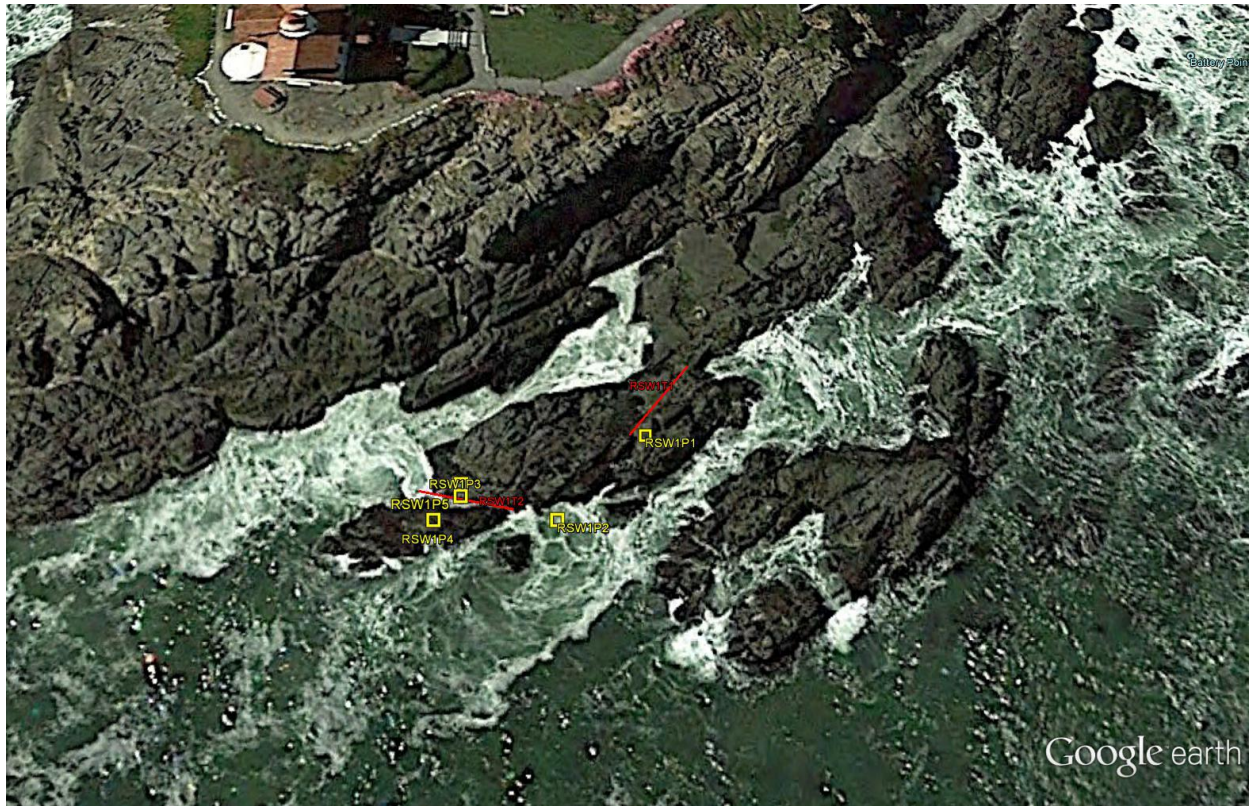

Figure 2. Locations of plots and transects at Battery Point (Site RSW-001).

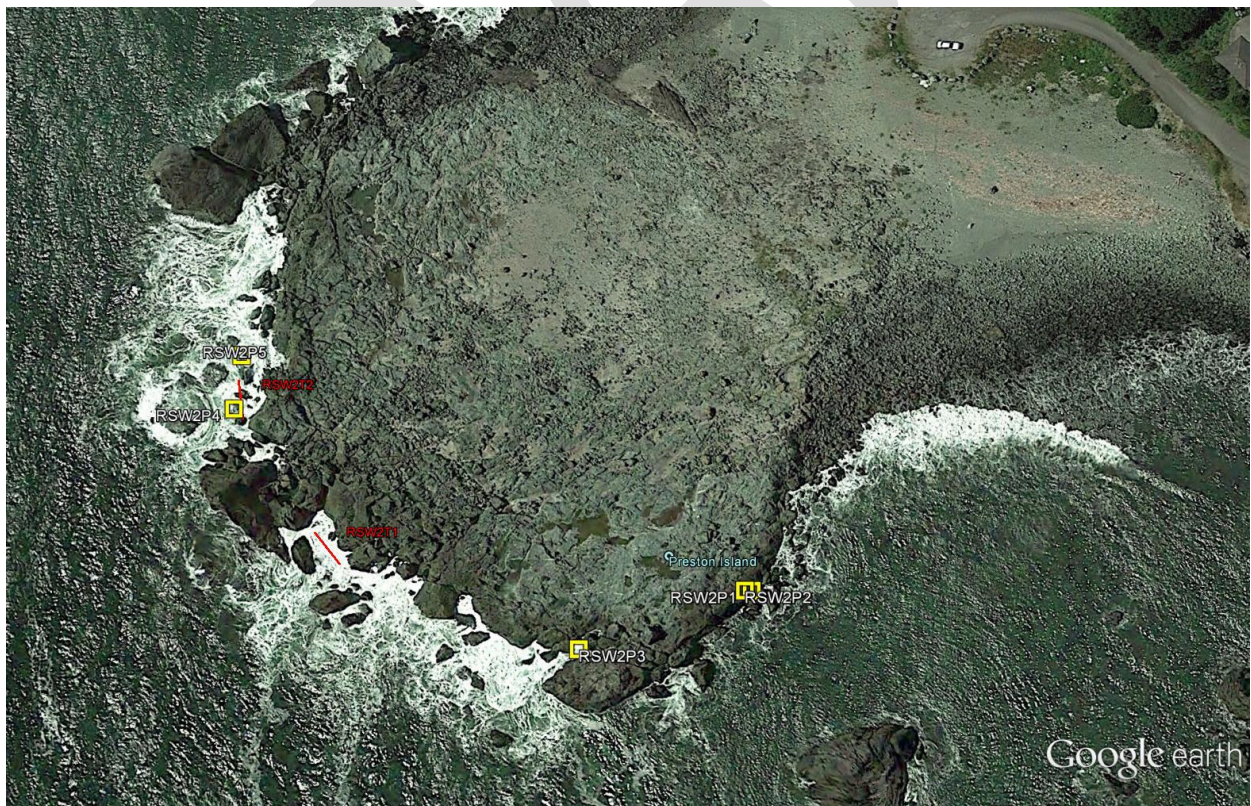

Figure 3. Locations of plots and transects at Preston Island (Site RSW-001).

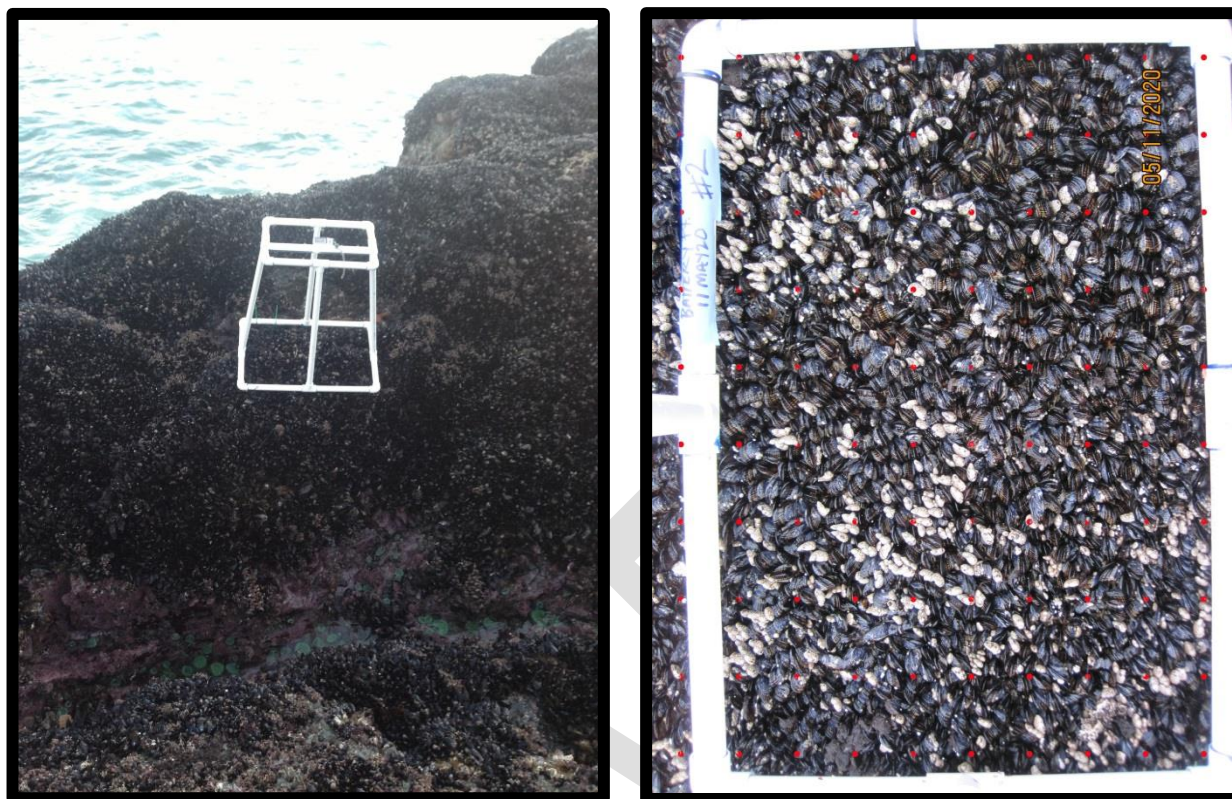

Figure 4. Quadrupod with camera setup (RSW-001 site) and image with superimposed dots.

Results

Marine macroalgae and invertebrate species compositions were similar between the study and control sites with *M. californianus* (California mussel) dominant in the plots and transects. (Figures 5, 6). *Mytilus californianus* occupied approximately 60 percent of the targeted habitat at RSW-001 (Battery Point) and 70 percent of the targeted habitat at RSW-002 (Preston Island). *Endocladia muricata* (turfweed) and *P. polymerus* (goose barnacle) shared the second most abundant cover values in Battery Point plots while *C. dalli*/*Balanus glandula* (white barnacle) was the second most abundant cover type at Preston Island.

The abundance of *Pisaster ochraceus* was much higher at the Preston Island (RSW-002) and average size for both orange and purple varieties was higher but may be due to physical access constraints (dangerous) at Battery Point. The total numbers of orange and purple *P. ochraceus* at Battery Point and Preston Island plots were 27 and 6, and 54 and 33, respectively, and the average arm size was larger for Orange (8.2cm:6.1cm) and purple (7.1cm:5. cm).

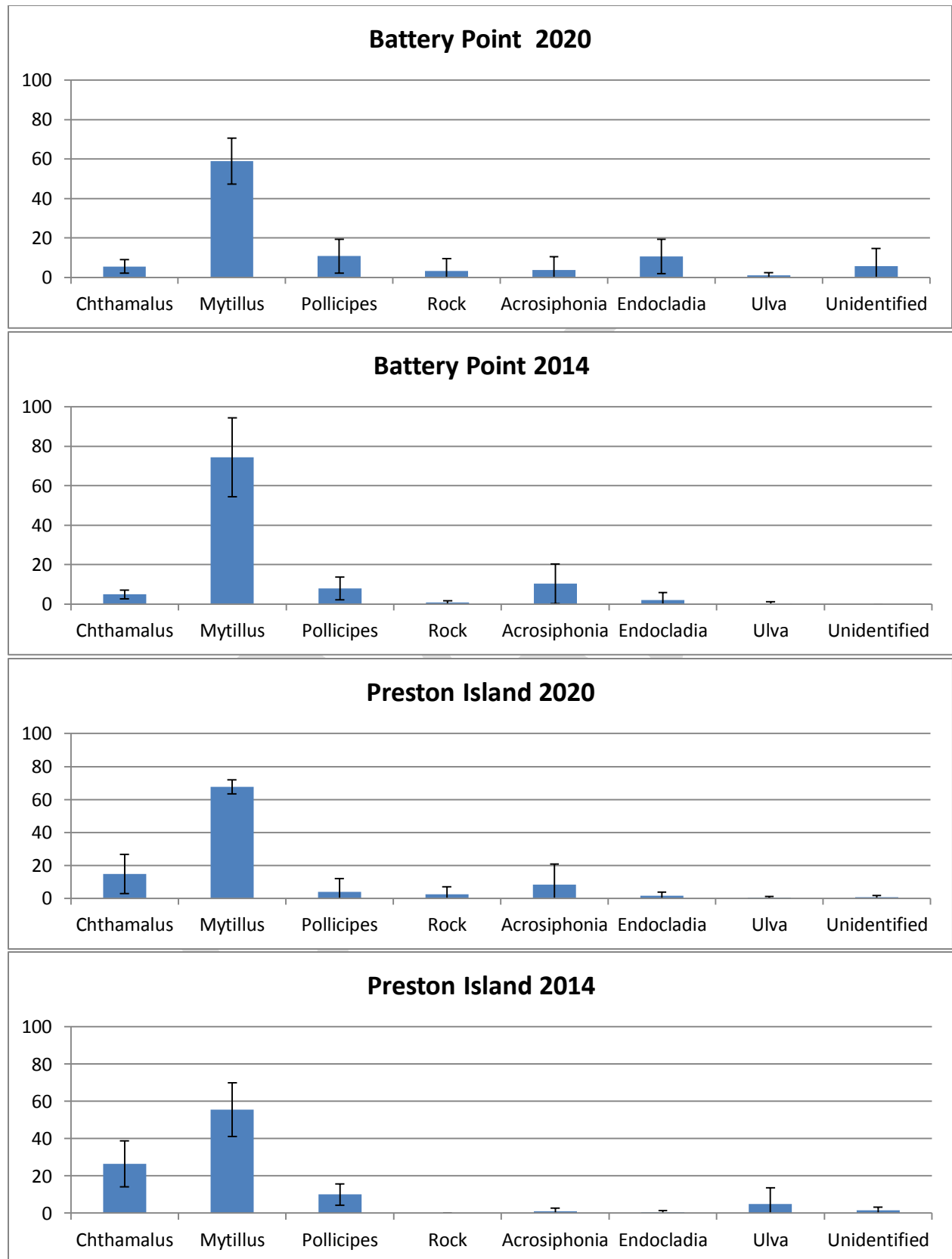

Figure 5. Summarized results and error from Battery Point photoplots.

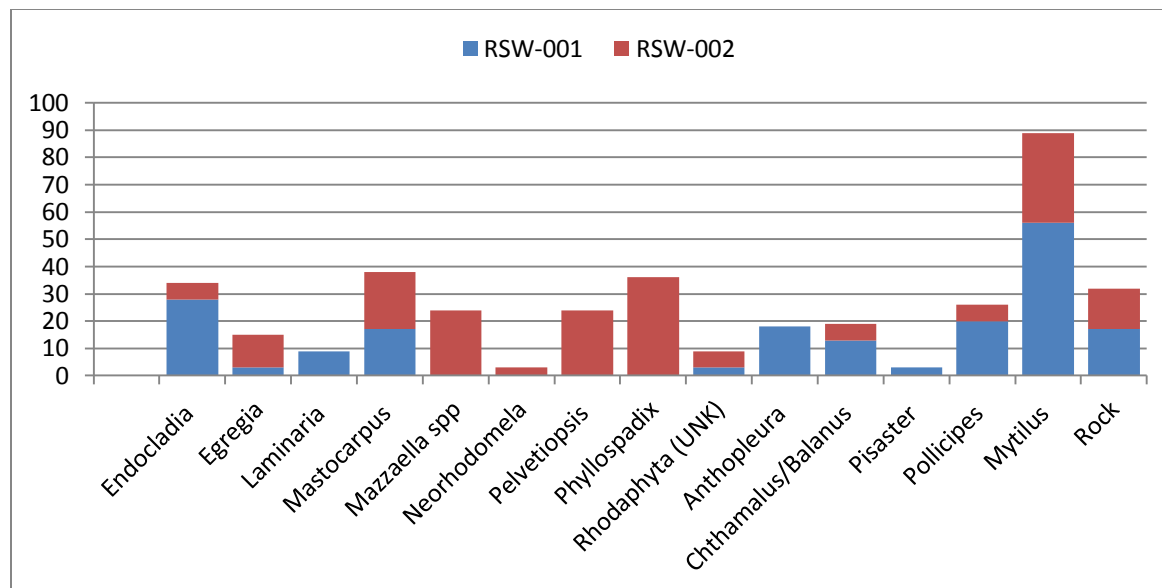

Figure 6. Combined transect information from RSW-001 and RSW-002.

Observations of sea birds and marine mammals were recorded from August 2013 to May 2015. These species can be found in the species list. Notable bird and mammal visitors to the intertidal area immediately adjacent to the outfall included the frequently observed Black Oyster Catcher (*Haematopus bahmani*), Black Turnstone (*Arenaria melanocephala*), Pigeon Guillemot (*Cephus Columba*), Western Gull (*Larus occidentalis*), and California Sea Lion (*Zalophus californianus*).

Discussion

Hazardous seas and late evening and early morning tides resulted in reduced opportunities to survey Battery Point (RSW-001) and Preston Island (RSW-002). However, the fifteen site visits that occurred over the two-year study period allowed multiple opportunities to observe any objectionable conditions of the receiving waters at or near the outfall.

On December 10, 2019 it was noted that there were fresh signs of superficial erosion of the concrete surrounding the outfall. Other observations noted during surveys were that bull kelp was notably more abundant during fall surveys at Battery Point in late 2018 compared to fall surveys in late 2019. Although purple sea urchin (*Strongylocentrotus purpuratus*) were not part of this survey, anecdotally they appear to be increasing in abundance.

Conclusion

No floating particulates, grease, discoloration of water or crustaceans, or observations of an objectionable nature were observed during plot surveys. This study found no evidence that suggested degradation of biota in the receiving waters from Crescent City WWTF discharge.

References

- Engle, J.M. Unified Monitoring Protocols for the Multi-Agency Rocky Intertidal Network. MMS Cooperative Agreement No. 14-35-0001-30761. Marine Science Institute, UC Santa Barbara, CA. 84 p.
- Irvine, G.V., 2010, Development of monitoring protocols to detect change in rocky intertidal communities of Glacier Bay National Park and Preserve: U.S. Geological Survey Open-File Report 2010-1283, 140p.
- Larson, Z. S. 2015. Crescent City Ocean Outfall Biological Survey Report. Prepared for the City of Crescent City. 14p.
- Richards, D.V., and G.E. Davis. 1988, Rocky intertidal communities monitoring handbook, Channel Islands National Park, California, National Park Service, Ventura, CA, 78 p.
- Warburton, K.M. 2005. Effects of a wastewater outfall in a rocky intertidal community. Humboldt State University Masters Thesis. 58 p.
- Personal Communication
F. Shaughnessy (Humboldt State University) 6/9/2020



Appendix A: List of Primary Species Observed

MARINE INVERTEBRATES: *Amphipholus* spp. (brittle star)

Amphiporus sp.(ribbon worm)

Anisodoris nobilis (Pacific sea-lemon)

Anthopleura elegantissima (aggregating anemone)

Anthopleura xanthogrammica (giant green anemone)

Balanus glandula (white barnacle)

Chthamalus dalli/fissus (white barnacle)

Chlorostoma funebris (black turban snail)

Collisella spp.

Dermasterias imbricata (leather star)

Henricia leviuscula (blood star)

Hemigrapsus nudus (purple shore crab)

Katharina tunicata (black katy chiton)

Littorina scutula (checkered periwinkle)

Lottia strigatella (checkered limpet)

Notoacmea scutum

Pachygrapsus crassipes (striped shore crab)

Pagurus spp. (hermit crab)

Pisaster ochraceus (ochre sea star)

Semibalanus cariosus (thatched barnacle)

Strongylocentrotus purpuratus (purple seas urchin)

Tegula funebris

Tonicella lineata (lined chiton)

BIRDS:

Aechmophorus occidentalis (Western Grebe)

Ardea herodias (Great Blue Heron)

Arenaria melanocephala (Black Turnstone)

Calidris mauri (Western Sandpiper)

Cephus Columba (Pigeon Guillemot)

Hirundinidae (Swallow Family)

Haematopus bahmani (Black Oystercatcher)

Larus occidentalis (Western Gull)

Phalacrocorax pelagicus (Pelagic Cormorant)

MAMMALS:

Phoca vitulina (harbor seal)

Zalophus californianus (California sea lion)

PLANTS:

Acrosiphonia arcta (Arctic sea moss)

Analipus japonicus



Cladophora sp.
Constantine simplex (cup and saucer seaweed)
Corallinales spp. (Coralline seaweed)
Cryptopleura sp.
Egregia menziesii (feather boa kelp)
Endocladia muricata (turfweed)
Fucus gardneri (rockweed)
Hymenena sp.
Laminaria spp.
Mastocarpus papillatus (Turkish washcloth)
Mazzaella spp.
Microcladia borealis
Neorhodomela larix (black pine)
Nereocystis luetkeana (bull kelp)
Pelvetiopsis limitata (dwarf rockweed)
Phyllospadix spp. (surfgrass)
Prionitis lanceolate



Appendix B: Survey Dates and Tide Information

Date	Height	Time	Location
12/7/2018	-0.82	5:53 PM	Battery Point
1/2/2019	-0.04	3:40 PM	Preston Island
1/3/2019	-0.34	4:22 PM	Battery Point
4/3/2019	0.53	5:43 PM	Battery Point
4/21/2019	-1.12	7:54 AM	Preston Island
4/22/2019	-0.99	8:44 AM	Battery Point
4/23/2019	-0.69	9:28 AM	Battery Point
12/10/2019	-2.6	4:42 PM	Battery Point
4/4/2020	-0.4	3:50 PM	Battery Point
5/9/2020	-1.87	7:56 AM	Battery Point
5/11/2020	-1.25	9:38 AM	Battery Point
5/12/2020	-0.74	10:32 AM	Battery Point/Preston Island
5/22/2020	-0.64	6:30 AM	Battery Point
5/24/2020	-1.01	7:42 AM	Preston Island
5/25/2020	-1.05	8:22 AM	Battery Point